

LMZ20501 1-A Nano Module

1 Features

- Integrated inductor
- Miniature 3.5-mm × 3.5-mm × 1.75-mm package
- 1-A maximum load current
- Input voltage range of 2.7 V to 5.5 V
- Adjustable output voltage range of 0.8 V to 3.6 V
- ± 1% feedback tolerance over temperature
- 2.4- μ A (maximum) quiescent current in shutdown
- 3-MHz fixed PWM switching frequency
- -40°C to 125°C junction temperature range
- Power-good flag function
- Pin-selectable switching modes
- Internal compensation and soft start
- Current limit, thermal shutdown, and UVLO protection
- Create a custom design using the LMZ20501 with [WEBENCH® Power Designer](#)

2 Applications

- [Point-of-load regulation](#)
- [Space-constrained applications](#)

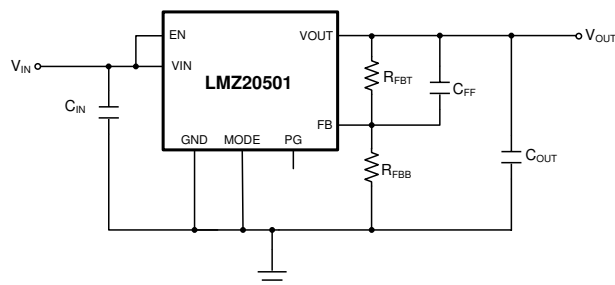

Simplified Schematic

3 Description

The LMZ20501 nano module regulator is an easy-to-use synchronous step-down DC/DC converter capable of driving up to 1 A of load from an input of up to 5.5 V, with exceptional efficiency and output accuracy in a very small solution size. The innovative package contains the regulator and inductor in a small 3.5 mm × 3.5 mm × 1.75 mm volume, thus saving board space and eliminating the time and expense of inductor selection. The LMZ20501 requires only five external components and has a pin-out designed for simple, optimum PCB layout. The device provides for an easy to use complete design with a minimum number of external components and the TI WEBENCH® design tool. TI's WEBENCH tool includes features such as external component calculation, electrical simulation, and WebTherm®. For soldering information, see [SNOA401](#).

Device Information

PART NUMBER	PACKAGE ⁽¹⁾	BODY SIZE (NOM)
LMZ20501	USIP (8)	3.50 mm × 3.50 mm

- (1) For all available packages, see the orderable addendum at the end of the data sheet.

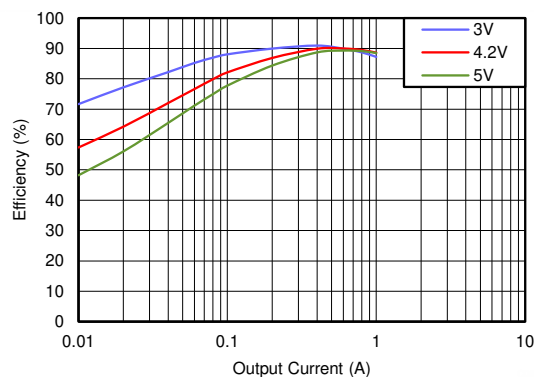

Typical Efficiency for $V_{OUT} = 1.8$ V Auto Mode



Table of Contents

1 Features	1	8.1 Application Information.....	16
2 Applications	1	8.2 Typical Application.....	16
3 Description	1	8.3 Do's and Don'ts.....	23
4 Revision History	2	9 Power Supply Recommendations	23
5 Pin Configuration and Functions	3	10 Layout	24
6 Specifications	4	10.1 Layout Guidelines.....	24
6.1 Absolute Maximum Ratings.....	4	10.2 Layout Example.....	25
6.2 ESD Ratings.....	4	11 Device and Documentation Support	27
6.3 Recommended Operating Conditions.....	4	11.1 Device Support.....	27
6.4 Thermal Information.....	4	11.2 Documentation Support.....	27
6.5 Electrical Characteristics.....	5	11.3 Receiving Notification of Documentation Updates..	28
6.6 System Characteristics.....	6	11.4 Support Resources.....	28
6.7 Typical Characteristics.....	8	11.5 Trademarks.....	28
7 Detailed Description	9	11.6 Electrostatic Discharge Caution.....	28
7.1 Overview.....	9	11.7 Glossary.....	28
7.2 Functional Block Diagram.....	9	12 Mechanical, Packaging, and Orderable Information	29
7.3 Feature Description.....	9	12.1 Tape and Reel Information.....	29
7.4 Device Functional Modes.....	13		
8 Application and Implementation	16		

4 Revision History

NOTE: Page numbers for previous revisions may differ from page numbers in the current version.

Changes from Revision D (August 2018) to Revision E (September 2021)	Page
• Updated the numbering format for tables, figures, and cross-references throughout the document.	1
• Updated Figure 7-3 title.....	10

Changes from Revision C (April 2015) to Revision D (August 2018)	Page
• Deleted Simple Switcher branding; added links for WEBENCH	1

5 Pin Configuration and Functions

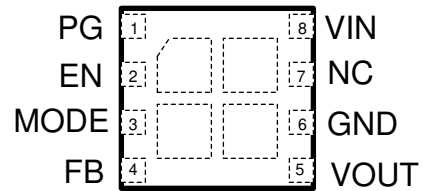

Figure 5-1. 8-Pins USIP Package (SIL) (Top View)

Table 5-1. Pin Functions

PIN		TYPE ⁽¹⁾	DESCRIPTION
NUMBER	NAME		
1	PG	O	Power-good flag; open drain. Connect to logic supply through a resistor. High = power good; low = power bad. If not used, leave unconnected.
2	EN	I	Enable input. High = On, Low = Off. A valid input voltage, on pin 8, must be present before EN is asserted. Do not float.
3	MODE	I	Mode selection input. High = forced PWM. Low = AUTO mode with PFM at light load. Do not float.
4	FB	I	Feedback input to controller. Connect to output through feedback divider.
5	VOUT	P	Regulated output voltage. Connect to C _{OUT} .
6	GND	G	Ground for all circuitry. Reference point for all voltages
7	NC	—	This pin must be left floating. Do not connect to ground or any other node.
8	VIN	P	Input supply to regulator. Connect to input capacitor(s) as close as possible to the VIN pin and GND pin of the module.
EP	EP	G	Ground and heat-sink connection. See Section 10.1 for more information.

(1) G = Ground, I = Input, O = Output, P = Power

6 Specifications

6.1 Absolute Maximum Ratings

Under the recommended operating junction temperature range of -40°C to 125°C (unless otherwise noted) ⁽¹⁾

	MIN	MAX	UNIT
VIN to GND	-0.2	6	V
EN, MODE, FB, PG, to GND ⁽²⁾	-0.2	V _{IN} +0.2	
VOU to GND ⁽²⁾	-0.2	V _{IN} +0.2	
Junction temperature		150	$^{\circ}\text{C}$
Peak soldering reflow temperature for Pb ⁽³⁾		240	$^{\circ}\text{C}$
Peak soldering reflow temperature for No-Pb ⁽³⁾		260	
Storage temperature range	-65	150	$^{\circ}\text{C}$

- (1) Stresses beyond those listed under *Absolute Maximum Ratings* may cause permanent damage to the device. These are stress ratings only, which do not imply functional operation of the device at these or any other conditions beyond those indicated under *Recommended Operating Conditions*. Exposure to absolute-maximum-rated conditions for extended periods may affect device reliability.
- (2) The absolute maximum voltage on this pin must not exceed 6 V with respect to ground. Do not allow the voltage on the output pin to exceed the voltage on the input pin by more than 0.2 V.
- (3) For soldering information, please refer to the following document: [SNOA401](#).

6.2 ESD Ratings

			VALUE	UNIT
V _(ESD)	Electrostatic discharge	Human body model (HBM), per ANSI/ESDA/JEDEC JS-001, all pins ⁽¹⁾	± 2000	V
		Charged-device model (CDM), per JEDEC specification JESD22-C101, all pins ⁽²⁾	± 500	

- (1) JEDEC document JEP155 states that 500-V HBM allows safe manufacturing with a standard ESD control process.
- (2) JEDEC document JEP157 states that 250-V CDM allows safe manufacturing with a standard ESD control process.

6.3 Recommended Operating Conditions

Under the recommended operating junction temperature range of -40°C to 125°C (unless otherwise noted) ⁽¹⁾

	MIN	NOM	MAX	UNIT
Input voltage	2.7		5.5	V
Output voltage programming	0.8		3.6	V
Output voltage range ⁽²⁾	0		3.6	V
Load current	0		1	A
Power good flag current	0		4	mA
Junction temperature	-40		125	$^{\circ}\text{C}$

- (1) Stresses beyond those listed under *Absolute Maximum Ratings* may cause permanent damage to the device. These are stress ratings only, which do not imply functional operation of the device at these or any other conditions beyond those indicated under *Recommended Operating Conditions*. Exposure to absolute-maximum-rated conditions for extended periods may affect device reliability.
- (2) Under no conditions should the output voltage be allowed to fall below zero volts.

6.4 Thermal Information

THERMAL METRIC ⁽¹⁾		LMZ20501	UNIT
		USIP (SIL)	
		8 PINS	
R _{θJA}	Junction-to-ambient thermal resistance	42.6	$^{\circ}\text{C}/\text{W}$
R _{θJC(top)}	Junction-to-case (top) thermal resistance	20.8	$^{\circ}\text{C}/\text{W}$
R _{θJB}	Junction-to-board thermal resistance	9.4	$^{\circ}\text{C}/\text{W}$
ψ _{JT}	Junction-to-top characterization parameter	1.5	$^{\circ}\text{C}/\text{W}$
ψ _{JB}	Junction-to-board characterization parameter	9.3	$^{\circ}\text{C}/\text{W}$

THERMAL METRIC ⁽¹⁾	LMZ20501	UNIT
	USIP (SIL)	
	8 PINS	
R _{θJC(bot)} Junction-to-case (bottom) thermal resistance	1.8	°C/W

- (1) The values given in this table are only valid for comparison with other packages and can not be used for design purposes. For design information please see the [Section 8.2.1.5](#) section. For more information about traditional and new thermal metrics, see the *Semiconductor and IC Package Thermal Metrics* application report, [SPRA953](#).

6.5 Electrical Characteristics

Limits apply over the recommended operating junction temperature range of –40°C to 125°C, unless otherwise noted. Minimum and maximum limits are verified through test, design, or statistical correlation. Typical values represent the most likely parametric norm at T_J = 25°C, and are provided for reference purposes only. Unless otherwise stated the following conditions apply: V_{IN} = 3.6 V

PARAMETER	TEST CONDITIONS	MIN ⁽¹⁾	TYP	MAX ⁽¹⁾	UNIT	
V _{FB}	Feedback voltage V _{IN} = 3.6 V	0.594	0.6	0.606	V	
I _{Q_AUTO}	Operating quiescent current in AUTO mode AUTO mode, V _{FB} = 0.8 V		72	90	μA	
I _{Q_PWM}	Operating quiescent current in forced PWM mode PWM mode, V _{FB} = 0.8 V		490	620	μA	
I _{Q_off}	Shutdown quiescent current ⁽²⁾ V _{IN} = 3.6 V, V _{EN} = 0.0 V		0.7	1.5	μA	
			1.0	2.4		
V _{UVLO}	Input supply undervoltage lockout thresholds	Rising	2.5		V	
		Falling	2.3			
V _{EN}	High level input voltage	V _{IH}	1.4		V	
	Low level input voltage	V _{IL}		0.4		
V _{MODE}	High level input voltage	V _{IH}	1.2		V	
	Low level input voltage	V _{IL}		0.4		
I _{LIM}	Peak switch current limit ⁽³⁾		1.3	1.7	A	
F _{osc}	Internal oscillator frequency		2.5	3.0	3.2	MHz
T _{ON}	Minimum switch on time ⁽⁵⁾		50		ns	
T _{ss}	Soft-start time ⁽⁵⁾		800		μs	
R _{PG}	Power-good flag pulldown R _{dson}		40	70	110	Ω
V _{PG1}	Power good flag, undervoltage trip ⁽⁴⁾	% of feedback voltage, rising		92%		
V _{PG2}	Power good flag, undervoltage trip ⁽⁴⁾	% of feedback voltage, falling		88%		
V _{PG3}	Power good flag, overvoltage trip ⁽⁴⁾	% of feedback voltage, rising		112%		
V _{PG4}	Power good flag, overvoltage trip ⁽⁴⁾	% of feedback voltage, falling		108%		
T _{SD}	Thermal shutdown ⁽⁵⁾	Rising threshold		159	°C	
	Thermal shutdown hysteresis ⁽⁵⁾			15	°C	

- (1) MIN and MAX limits are 100% production tested at 25°C. Limits over the operating temperature range are verified through correlation using Statistical Quality Control (SQC) methods. Limits are used to calculate Average Outgoing Quality Level (AOQL).
- (2) Shutdown current includes leakage current of the switching transistors.
- (3) This is the peak switch current limit measured with a slow current ramp. Due to inherent delays in the current limit comparator, the peak current limit measured at 3MHz will be larger.
- (4) See [Section 7.3.6](#) for explanation of voltage levels.
- (5) This parameter is not tested in production.

6.6 System Characteristics

The following specifications apply to the circuit found in [Figure 8-1](#) with the appropriate modifications from [Table 8-1](#). **These parameters are not tested in production and represent typical performance only.** Unless otherwise stated the following conditions apply: $T_A = 25^\circ\text{C}$.

PARAMETER		TEST CONDITIONS	MIN	TYP	MAX	UNIT
Load Regulation	Percent output voltage change for the given load current change	$V_{OUT} = 1.2\text{ V}$, $V_{IN} = 5\text{ V}$, $I_{OUT} = 0\text{ A to }1\text{ A}$, PWM		0.14%		
		$V_{OUT} = 1.8\text{ V}$ $V_{IN} = 5\text{ V}$, $I_{OUT} = 0\text{ A to }1\text{ A}$, PWM		0.15%		
		$V_{OUT} = 3.3\text{ V}$ $V_{IN} = 5\text{ V}$, $I_{OUT} = 0\text{ A to }1\text{ A}$, PWM		0.11%		
Line Regulation	Percent output voltage change for the given change in input voltage	$V_{OUT} = 1.2\text{ V}$ $I_{OUT} = 1\text{ A}$, $V_{IN} = 3\text{ V to }5\text{ V}$, PWM		0.16%		
		$V_{OUT} = 1.8\text{ V}$ $I_{OUT} = 1\text{ A}$, $V_{IN} = 3\text{ V to }5\text{ V}$, PWM		0.12%		
		$V_{OUT} = 3.3\text{ V}$ $I_{OUT} = 1\text{ A}$, $V_{IN} = 4\text{ V to }5\text{ V}$, PWM		0.1%		
V_{R-PWM}	Output voltage ripple in PWM	$V_{OUT} = 1.2\text{ V}$ $I_{OUT} = 1\text{ A}$, $V_{IN} = 5\text{ V}$, PWM		3.3		mV pk-pk
		$V_{OUT} = 1.8\text{ V}$ $I_{OUT} = 1\text{ A}$, $V_{IN} = 5\text{ V}$, PWM		3.3		
		$V_{OUT} = 3.3\text{ V}$ $I_{OUT} = 1\text{ A}$, $V_{IN} = 5\text{ V}$, PWM		4.2		
V_{R-PFM}	Output voltage ripple in PFM	$V_{OUT} = 1.2\text{ V}$ $I_{OUT} = 1\text{ mA}$, $V_{IN} = 3\text{ V}$, PFM		22		mV pk-pk
		$V_{OUT} = 1.8\text{ V}$ $I_{OUT} = 1\text{ mA}$, $V_{IN} = 3\text{ V}$, PFM		22		
		$V_{OUT} = 3.3\text{ V}$ $I_{OUT} = 1\text{ mA}$, $V_{IN} = 5\text{ V}$, PFM		40		
Load Transient	Output voltage deviation from nominal due to a load current step	$V_{OUT} = 1.2\text{ V}$ $V_{IN} = 5\text{ V}$, $I_{OUT} = 0\text{ A to }1\text{ A}$, $T_r = T_f = 2\text{ }\mu\text{s}$, PWM		± 60		mV
		$V_{OUT} = 1.8\text{ V}$ $V_{IN} = 5\text{ V}$, $I_{OUT} = 0\text{ A to }1\text{ A}$, $T_r = T_f = 2\text{ }\mu\text{s}$, PWM		± 50		
		$V_{OUT} = 3.3\text{ V}$ $V_{IN} = 5\text{ V}$, $I_{OUT} = 0\text{ A to }1\text{ A}$, $T_r = T_f = 2\text{ }\mu\text{s}$, PWM		± 60		
Line Transient	Output voltage deviation due to an input voltage step	$V_{OUT} = 1.2\text{ V}$ $I_{OUT} = 1\text{ A}$, $V_{IN} = 3\text{ V to }5\text{ V}$, $T_r = T_f = 50\text{ }\mu\text{s}$, PWM		25		mV pk-pk
		$V_{OUT} = 1.8\text{ V}$ $I_{OUT} = 1\text{ A}$, $V_{IN} = 3\text{ V to }5\text{ V}$, $T_r = T_f = 50\text{ }\mu\text{s}$, PWM		30		
		$V_{OUT} = 3.3\text{ V}$ $I_{OUT} = 1\text{ A}$, $V_{IN} = 4\text{ V to }5\text{ V}$, $T_r = T_f = 50\text{ }\mu\text{s}$, PWM		20		

The following specifications apply to the circuit found in [Figure 8-1](#) with the appropriate modifications from [Table 8-1](#). **These parameters are not tested in production and represent typical performance only.** Unless otherwise stated the following conditions apply: $T_A = 25^\circ\text{C}$.

PARAMETER		TEST CONDITIONS	MIN	TYP	MAX	UNIT
η	Peak efficiency	$V_{OUT} = 1.2\text{ V}$ $V_{IN} = 3\text{ V}$		87%		
		$V_{OUT} = 1.8\text{ V}$ $V_{IN} = 3\text{ V}$		91%		
		$V_{OUT} = 3.3\text{ V}$ $V_{IN} = 4.2\text{ V}$		94%		
	Full load efficiency	$V_{OUT} = 1.2\text{ V}$ $V_{IN} = 3\text{ V}, I_{OUT} = 1\text{ A}$		83%		
		$V_{OUT} = 1.8\text{ V}$ $V_{IN} = 3\text{ V}, I_{OUT} = 1\text{ A}$		87%		
		$V_{OUT} = 3.3\text{ V}$ $V_{IN} = 4.2\text{ V}, I_{OUT} = 1\text{ A}$		93%		

6.7 Typical Characteristics

Unless otherwise specified the following conditions apply: $V_{IN} = 3.6\text{ V}$, $T_A = 25^\circ\text{C}$.

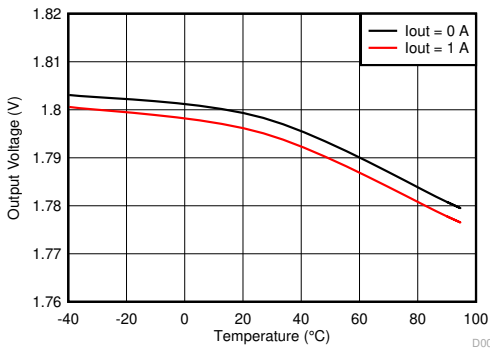

$V_{IN} = 3.6\text{ V}$ PWM Mode $V_{OUT} = 1.8\text{ V}$

Figure 6-1. Typical Output Voltage vs Temperature

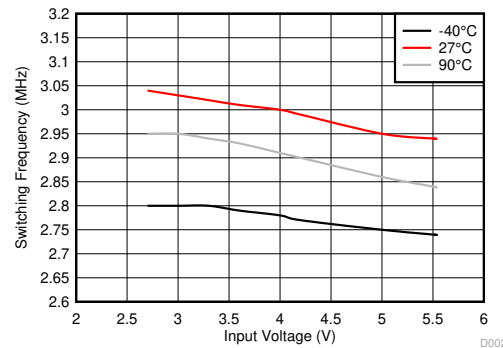

$V_{IN} = 3.6\text{ V}$ $I_{OUT} = 0\text{ A}$ PWM Mode

Figure 6-2. Switching Frequency in PWM Mode

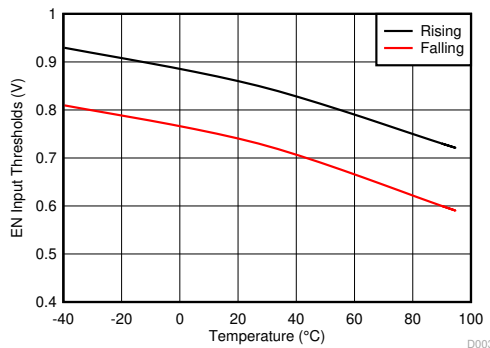

$V_{IN} = 3.6\text{ V}$

Figure 6-3. EN Input Thresholds

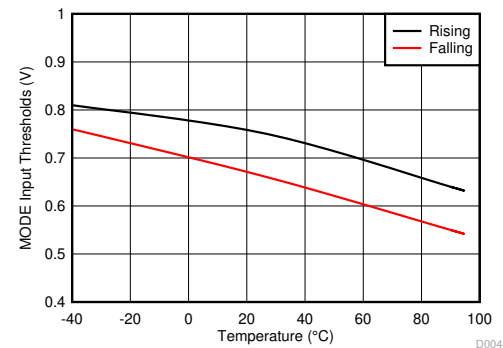

$V_{IN} = 3.6\text{ V}$

Figure 6-4. MODE Input Thresholds

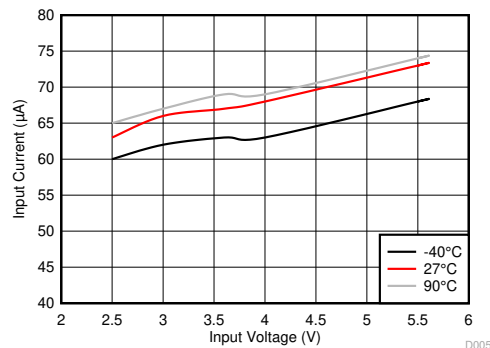

$V_{FB} = 0.8\text{ V}$ AUTO Mode

Figure 6-5. Non-Switching Input Current in AUTO Mode

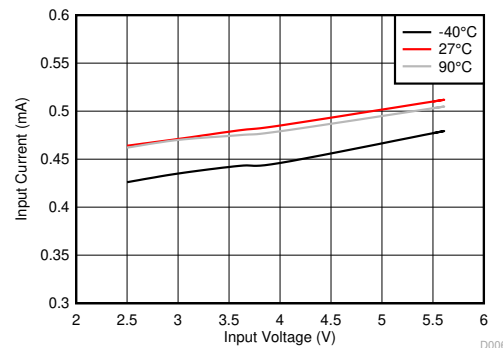

$V_{FB} = 0.8\text{ V}$ PWM Mode

Figure 6-6. Non-Switching Input Current in PWM Mode

7 Detailed Description

7.1 Overview

The LMZ20501 nano module is a voltage mode buck regulator with an integrated inductor. Input voltage feedforward is used to compensate for loop gain variation with input voltage. Two operating modes allow the user to tailor the regulator to their specific requirements. In forced PWM mode, the regulator operates as a full synchronous device with a 3 MHz (typical) switching frequency and very low output voltage ripple. In AUTO mode, the regulator moves into PFM when the load current drops below the mode change threshold (see [Section 8.2.2](#)). In PFM, the device regulates the output voltage between wider ripple limits than in PWM. This results in much smaller supply current than in PWM, at light loads, and high efficiency. A simplified block diagram is shown in [Section 7.2](#).

7.2 Functional Block Diagram

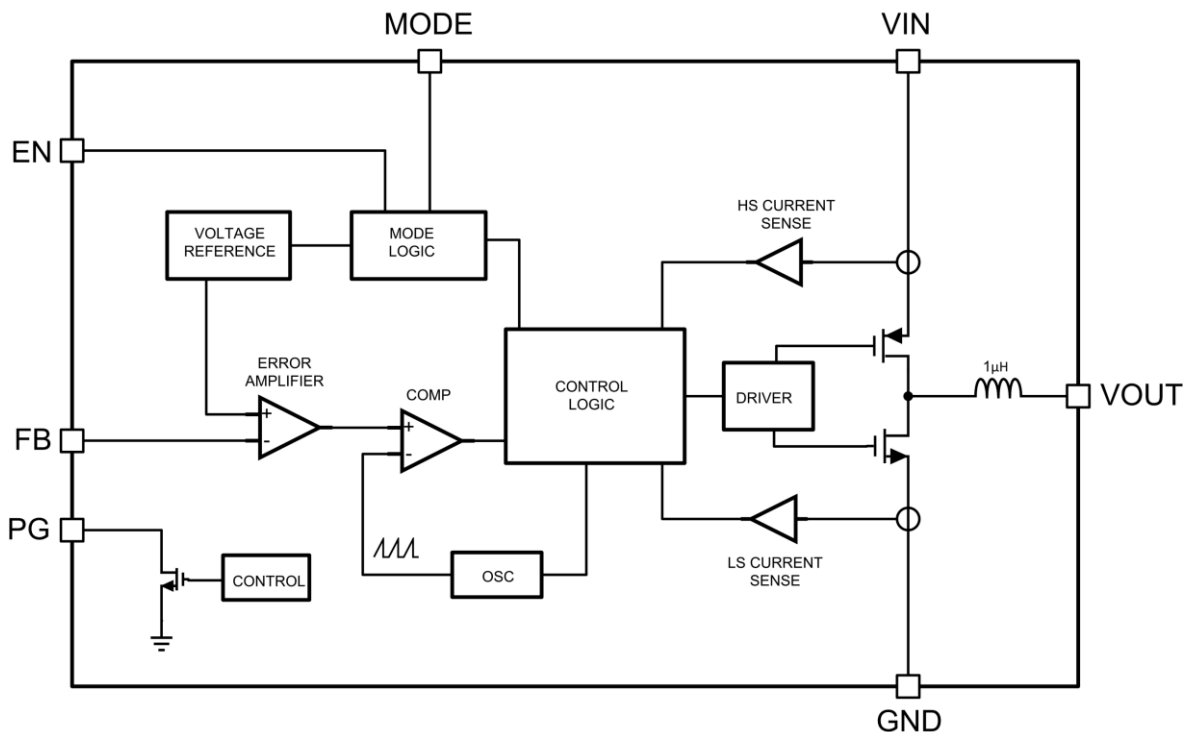

7.3 Feature Description

7.3.1 Nano Scale Package

The LMZ20501 incorporates world class package technology to provide a 1-A power supply with a total volume of only 21 mm³ (excluding external components). All that is required for a complete power supply is the addition of feedback resistors to set the output voltage and the input and output filter capacitors. [Figure 7-1](#) and [Figure 7-2](#) show the LMZ20501 package. The regulator die is embedded into a PCB substrate while the power inductor is mounted on top. Vias and copper clad are used to make the connections to the die, inductor, and the external components. This package is MSL3-compliant.

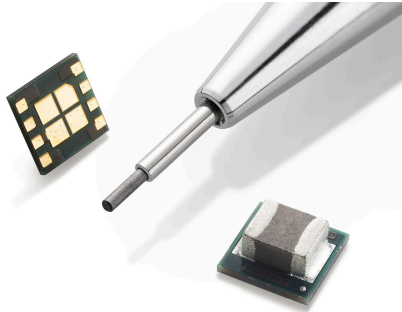

Figure 7-1. Package Photo

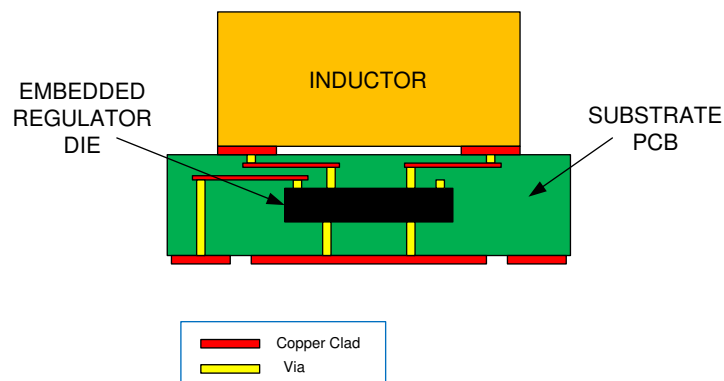

Figure 7-2. Package Side View Drawing

7.3.2 Internal Synchronous Rectifier

The LMZ20501 uses an internal NMOS FET as a synchronous rectifier to minimize switch voltage drop and increase efficiency. The NMOS is designed to conduct through its body diode during switch dead time. This dead time is imposed to prevent supply current "shoot-through".

7.3.3 Current Limit Protection

The LMZ20501 incorporates cycle-by-cycle peak current limit on both the high- and low-side MOSFETs. This feature limits the output current in case the output is overloaded. During the overload, the peak inductor current is limited to that value found in [Section 6.5](#) under the heading of " I_{LIM} ".

In addition to current limit, a short circuit protection mode is also implemented. When the feedback voltage is brought down to less than 300 mV, but greater than 150 mV, by a short circuit, the synchronous rectifier is turned off. This provides more voltage across the inductor to help maintain the required volt-second balance. If a "harder" short brings the feedback voltage to below 150 mV, the current limit and switching frequency are both reduced to approximately one half of the nominal values. In addition, when the current limit is tripped, the device stops switching for approximately 85 μ s. At the end of the time-out, switching resumes and the cycle repeats until the short is removed.

The effect of both overload and short circuit protection can be seen in [Figure 7-3](#). This graph demonstrates that the device will supply slightly more than 1 A to the load when in overload and much less current during fold-back mode. This is typical behavior for any regulator with this type of current limit protection.

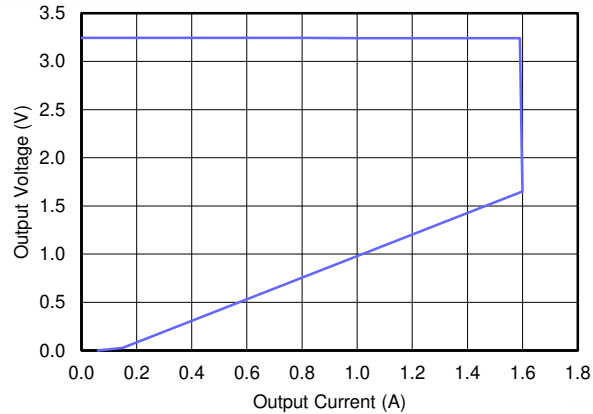

Figure 7-3. Typical Current Limit Profile $V_{IN} = 5\text{ V}$, $V_{OUT} = 3.3\text{ V}$

7.3.4 Start-Up

Start-up and shutdown of the LMZ20501 is controlled by the EN input. The characteristics of this input are found in [Section 6.5](#). A valid input voltage must be present on V_{IN} before the enable control is asserted. The maximum voltage on the EN pin is 5.5 V or V_{IN} , whichever is smaller. Do not allow this input to float.

The LMZ20501 features a current limit based soft start that prevents large inrush currents and output overshoots as the regulator is starting up. The peak inductor current is stepped-up in a staircase fashion during the soft start period. A typical start-up event is shown in [Figure 7-4](#):

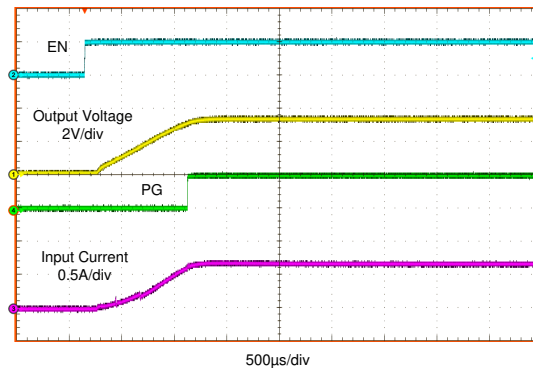

Figure 7-4. Typical Start-Up Waveforms, $V_{IN} = 5\text{ V}$, $V_{OUT} = 3.3\text{ V}$, $I_{OUT} = 1\text{ A}$

7.3.5 Dropout Behavior

When the input voltage is close to the output voltage, the regulator will operate at very large duty cycles. Normal time delays of the internal circuits prevents the attainment of controlled duty cycles near 100%. In this condition, the LMZ20501 will skip switching cycles to maintain regulation with the highest possible input-to-output ratio. Some increase in output voltage ripple can appear as the regulator skips cycles. As the input voltage gets closer to the output voltage, the regulator will eventually reach 100% duty cycle, with the high side switch turned on. The output will then follow the input voltage minus the drop across the high-side switch and inductor resistance. [Figure 7-5](#) and [Figure 7-6](#) show typical dropout behavior for output voltages of 2.5 V and 3.3 V.

Since the internal gate drive levels of the LMZ20501 are dependent on input voltage, the $R_{ds(on)}$ of the power FETs will increase at low input voltages. This will result in degraded efficiency at input voltages below approximately 2.9 V. Also, combinations of low input voltage and high output voltage increase the effective switch duty cycle, which can result in increased output voltage ripple.

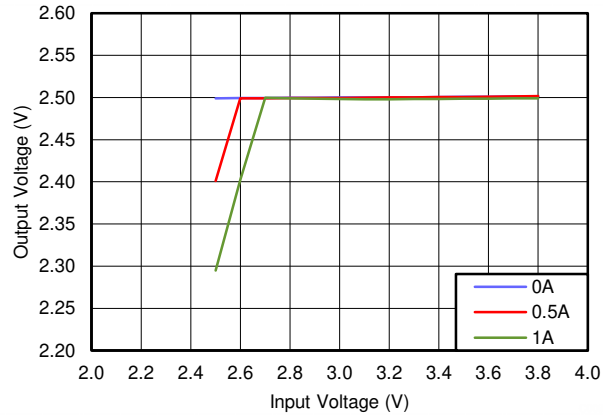

Figure 7-5. Typical Dropout Behavior, $V_{OUT} = 2.5\text{ V}$

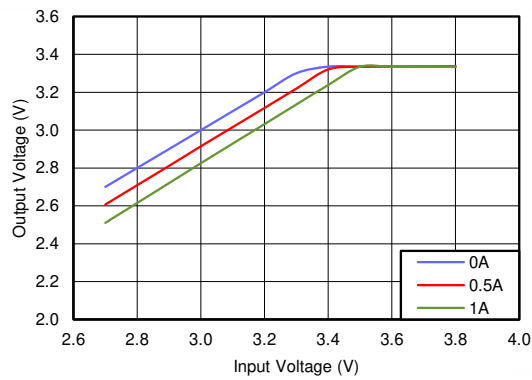

Figure 7-6. Typical Dropout Behavior, $V_{OUT} = 3.3\text{ V}$

7.3.6 Power Good Flag Function

The operation of the power good flag function is described in the diagram shown in [Figure 7-7](#).

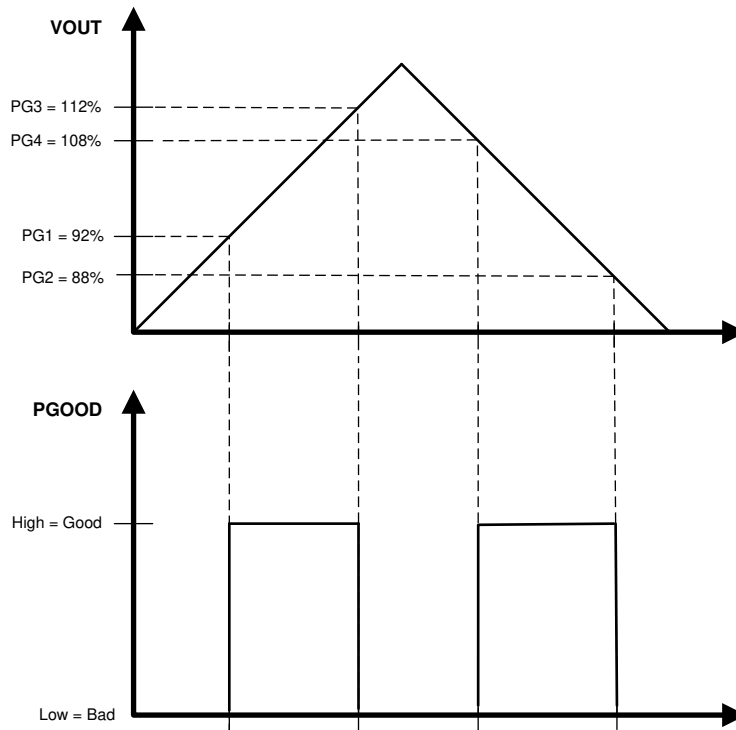

Figure 7-7. Typical Power Good-Flag Operation

This output consists of an open-drain NMOS with an R_{dson} of approximately $70\ \Omega$. When used, the power-good flag should be connected to a logic supply through a pullup resistor. It can also be pulled up to either V_{IN} or V_{OUT} through an appropriate resistor, as desired. If this function is not needed, the PG output should be left floating. The current through this flag pin should be limited to less than 4 mA. A pullup resistor of greater than or equal to $1.5\ k\Omega$ will satisfy this requirement. When the EN input is pulled low, the PG flag output will also be forced low, assuming a valid input voltage is present at the VIN pin.

7.3.7 Thermal Shutdown

The LMZ20501 incorporates a thermal shutdown feature to protect the device from excessive die temperatures. The device will stop switching when the internal die temperature reaches about 159°C . Switching will resume when the die temperature drops to about 144°C .

7.4 Device Functional Modes

Please refer to [Table 7-1](#) and the following paragraphs for a detailed description of the functional modes of the LMZ20501. These modes are controlled by the MODE input as shown in [Table 7-1](#). The maximum voltage on the MODE pin is 5.5 V or V_{IN} , whichever is smaller. This input must not be allowed to float.

Table 7-1. Mode Selection

MODE PIN VOLTAGE	OPERATION
> 1.2 V	Forced PWM: The regulator operates in constant frequency, PWM mode for all loads from no-load to full load; no diode emulation is used.
< 0.4 V	AUTO Mode: The regulator operates in constant frequency mode for loads greater than the mode change threshold. For loads less than the mode change threshold, the regulator operates in PFM with diode emulation.

7.4.1 PWM Operation

In forced PWM mode, the converter operates as a constant frequency voltage mode regulator with input voltage feedforward. This provides excellent line and load regulation and low output voltage ripple. This operation is maintained, even at no-load, by allowing the inductor current to reverse its normal direction. While in PWM mode, the output voltage is regulated by switching at a constant frequency and modulating the duty cycle to control the power to the load. This mode trades off reduced light load efficiency for low output voltage ripple and constant switching frequency. In this mode, a negative current limit of approximately 750 mA is imposed to prevent damage to the regulator power FETs.

7.4.2 PFM Operation

When in AUTO mode and at light loads, the device enters PFM. The regulator estimates the load current by measuring both the high-side and low-side switch currents. This estimate is only approximate, and the exact load current threshold, to trigger PFM, can vary greatly with input and output voltage. Section 8.2.2 shows mode change thresholds for several typical operating points. When the regulator detects this threshold, the reference voltage is increased by approximately 10 mV. This causes the output voltage to rise to meet the new regulation point. When this point is reached, the converter stops switching and much of the internal circuitry is shut off, while the reference is returned to the PWM value. This saves supply current while the output voltage naturally starts to fall under the influence of the load current. When the output voltage reaches the PWM regulation point, switching is again started and the reference voltage is again increased by approximately 10 mV, starting the next cycle. Typical waveforms are shown in Figure 7-8.

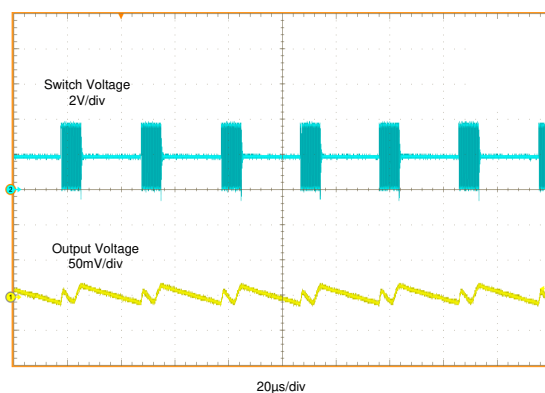

Figure 7-8. Typical PFM Mode Waveforms: $V_{IN} = 3.6\text{ V}$, $V_{OUT} = 1.8\text{ V}$, $I_{OUT} = 10\text{ mA}$

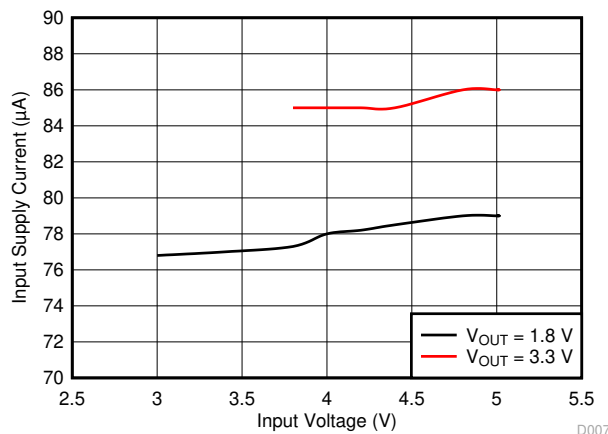

Figure 7-9. Typical No Load Input Supply Current

The actual output voltage ripple will depend on the feedback divider ratio and on the delay in the PFM comparator. The frequency of the PFM "bursts" will depend on the input voltage, output voltage, load, and

output capacitor. Within each "burst", the device switches at 3 MHz (typical). If the load current increases above the threshold, normal PWM operation is resumed. This mode provides high light load efficiency by reducing the amount of supply current required to regulate the output at small load currents. This mode trades off very good light load efficiency for larger output voltage ripple and variable switching frequency. An example of the typical input supply current while regulating with no load is shown in [Figure 7-9](#).

Because of normal part-to-part variation, the LMZ20501 may not switch into PFM mode at high input voltages. This can be seen with output voltages of approximately 1.2 V and below, and at input voltages of approximately 4.2 V and above.

8 Application and Implementation

Note

Information in the following applications sections is not part of the TI component specification, and TI does not warrant its accuracy or completeness. TI's customers are responsible for determining suitability of components for their purposes, as well as validating and testing their design implementation to confirm system functionality.

8.1 Application Information

The LMZ20501 is a step down DC-to-DC regulator. It is typically used to convert a higher DC voltage to a lower DC voltage with a maximum output current of 1 A. The following design procedure can be used to select components for the LMZ20501. Alternately, the WEBENCH design tool may be used to generate a complete design. WEBENCH utilizes an iterative design procedure and has access to a comprehensive database of components. This allows the tool to create an optimized design and allows the user to experiment with various design options.

8.2 Typical Application

Figure 8-1 shows the minimum required application circuit for a 1.8-V output. Figure 8-2 shows a full featured application circuit. Please refer to Figure 8-1 and Figure 8-2 during the following design procedures.

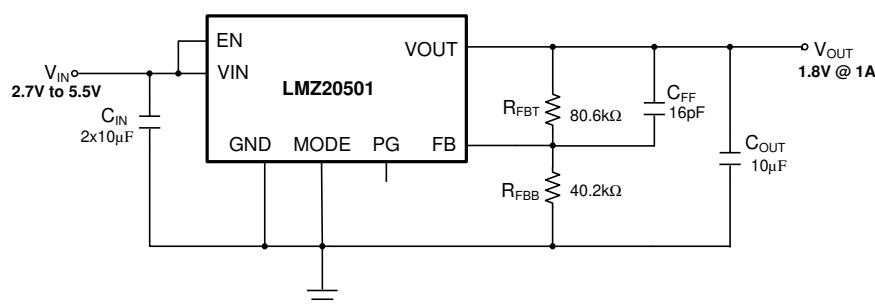

Figure 8-1. LMZ20501 Typical Application $V_{OUT} = 1.8\text{ V}$

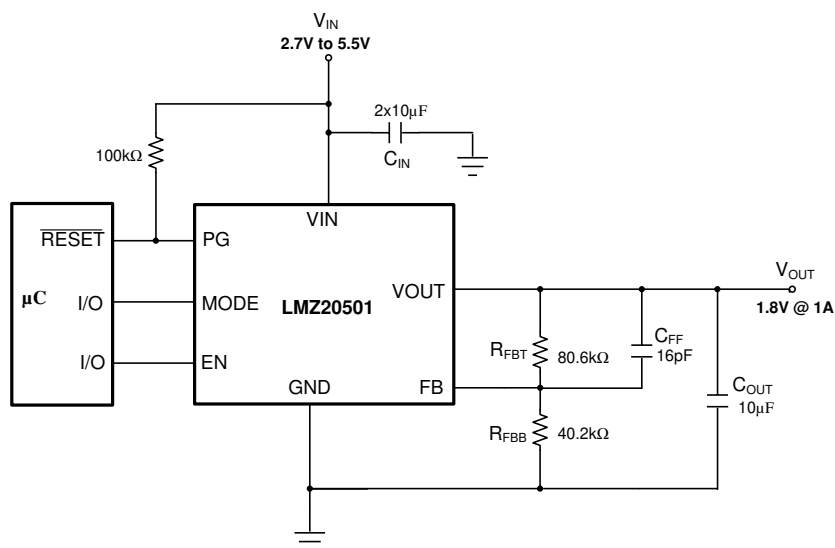

Figure 8-2. LMZ20501 Full Featured Application

8.2.1 Detailed Design Procedure

Please refer to [Table 8-1](#) while following the detailed design procedure. This procedure applies to both [Figure 8-1](#) and to [Figure 8-2](#). Also, the [Application Curves](#) apply to both schematics.

Table 8-1. Recommended Component Values

V _{OUT} (V)	R _{FBB} (kΩ)	R _{FBT} (kΩ)	C _{OUT} (μF)	EFFECTIVE C _{OUT} (μF) ⁽²⁾	C _{FF} (pF)	C _{IN} (μF) ⁽¹⁾	EFFECTIVE C _{IN} (μF) ⁽²⁾
0.8	121	40.2	2 x 10	18 μF	39	2 x 10	14
1.2	30.1	30.1	10	8.8 μF	20	2 x 10	14
1.8	40.2	80.6	10	8.4 μF	16	2 x 10	14
2.5	47.5	150	10	7.8 μF	12	2 x 10	14
3.3	53.2	237	10	7.1 μF	82	2 x 10	14
3.6	53.2	267	10	6.8 μF	82	2 x 10	14

(1) C_{IN} = C_{OUT} = 10 μF, 16 V, 0805, X7R, Samsung CL21B106KOQNNNE. C_{OUT} measured at V_{OUT}; C_{IN} measured at 3.3 V.

(2) The effective value takes into account the capacitor voltage coefficient.

8.2.1.1 Custom Design With WEBENCH® Tools

[Click here](#) to create a custom design using the LMZ20501 device with the WEBENCH® Power Designer.

1. Start by entering the input voltage (V_{IN}), output voltage (V_{OUT}), and output current (I_{OUT}) requirements.
2. Optimize the design for key parameters such as efficiency, footprint, and cost using the optimizer dial.
3. Compare the generated design with other possible solutions from Texas Instruments.

The WEBENCH Power Designer provides a customized schematic along with a list of materials with real-time pricing and component availability.

In most cases, these actions are available:

- Run electrical simulations to see important waveforms and circuit performance
- Run thermal simulations to understand board thermal performance
- Export customized schematic and layout into popular CAD formats
- Print PDF reports for the design, and share the design with colleagues

Get more information about WEBENCH tools at www.ti.com/WEBENCH.

8.2.1.2 Setting The Output Voltage

The LMZ20501 regulates its feedback voltage to 0.6 V (typical). A feedback divider, shown in [Figure 8-1](#), is used to set the desired output voltage. [Equation 1](#) can be used to select R_{FBB}.

$$R_{FBB} = \frac{0.6}{(V_{OUT} - 0.6)} \cdot R_{FBT} \quad (1)$$

For the best results, R_{FBT} should be chosen between 30 kΩ and 300 kΩ. See [Table 8-1](#) for recommended values for typical output voltages.

8.2.1.3 Output and Feedforward Capacitors

The LMZ20501 is designed to work with low-ESR ceramic capacitors. The **effective** value of these capacitors is defined as the actual capacitance under voltage bias and temperature. All ceramic capacitors have large voltage coefficients, in addition to normal tolerances and temperature coefficients. Under D.C. bias, the capacitance value drops considerably. Larger case sizes, higher voltage capacitors, or both are better in this regard. To help mitigate these effects, multiple small capacitors can be used in parallel to bring the minimum **effective** capacitance up to the desired value. This can also ease the RMS current requirements on a single capacitor. Typically, 10-V, X5R, 0805 capacitors are adequate for the output, while 16-V capacitors can be used on the input. Some recommended component values are provided in [Table 8-1](#). Also, shown are the measured values of **effective** input and output capacitance for the given capacitor. If smaller values of output capacitance are used, C_{FF} must be adjusted to give good phase margin. In any case, load transient response will be

compromised with lower values of output capacitance. Values much lower than those found in [Table 8-1](#) should be avoided.

In practice, the output capacitor and C_{FF} are adjusted for the best transient response and highest loop phase margin. Load transient testing and Bode plots are the best way to validate any given design. The [Optimizing Transient Response of Internally Compensated DC-DC Converters Application Report](#) should prove helpful when optimizing the feedforward capacitor. Also, the [AN-1889 How to Measure the Loop Transfer Function of Power Supplies Application Report](#) details a simple method of creating a Bode plot with basic laboratory equipment. The values of C_{FF} found in [Table 8-1](#) provide a good starting point.

A careful study of the temperature and bias voltage variation of any candidate ceramic capacitor should be made in order to make sure that the minimum values of **effective** capacitance are provided. The best way to obtain an optimum design is to use the Texas Instruments WEBENCH tool.

The maximum value of total output capacitance should be limited to between 100 μF and 200 μF . Large values of output capacitance can prevent the regulator from starting-up correctly and adversely affect the loop stability. If values in the range given above, or larger, are to be used, then a careful study of start-up at full load and loop stability must be performed.

8.2.1.4 Input Capacitors

The ceramic input capacitors provide a low impedance source to the regulator in addition to supplying ripple current and isolating switching noise from other circuits. An **effective** value of at least 14 μF is normally sufficient for the input capacitor. If the main input capacitor or capacitors cannot be placed close to the module, then a small 10 nF to 100 nF capacitor should be placed directly at the module across the supply and ground pins.

Many times, it is desirable to use an electrolytic capacitor on the input, in parallel with the ceramics. This is especially true if long leads/traces are used to connect the input supply to the regulator. The moderate ESR of this capacitor can help damp any ringing on the input supply caused by long power leads. This method can also help to reduce voltage spikes that can exceed the maximum input voltage rating of the LMZ20501. The use of this additional capacitor will also help with voltage dips caused by input supplies with unusually high impedance.

Most of the switching current passes through the input ceramic capacitor or capacitors. The approximate RMS value of this current can be calculated with [Equation 2](#) and should be checked against the manufactures maximum ratings.

$$I_{\text{RMS}} \approx \frac{I_{\text{OUT}}}{2} \quad (2)$$

8.2.1.5 Maximum Ambient Temperature

As with any power conversion device, the LMZ20501 will dissipate internal power while operating. The effect of this power dissipation is to raise the internal temperature of the converter above ambient. The internal die temperature is a function of the ambient temperature, the power loss, and the effective thermal resistance $R_{\theta\text{JA}}$ of the device and PCB combination. The maximum internal die temperature for the LMZ20501 is 125°C, thus establishing a limit on the maximum device power dissipation and, therefore, load current at high ambient temperatures. [Equation 3](#) shows the relationships between the important parameters.

$$I_{\text{OUT}} = \frac{(T_{\text{J}} - T_{\text{A}})}{R_{\theta\text{JA}}} \cdot \frac{\eta}{(1 - \eta)} \cdot \frac{1}{V_{\text{OUT}}} \quad (3)$$

It is easy to see that larger ambient temperatures and larger values of $R_{\theta\text{JA}}$ will reduce the maximum available output current. As stated in the [Semiconductor and IC Package Thermal Metrics Application Report](#), the values given in the [Thermal Information](#) table are not valid for design purposes and must not be used to estimate the thermal performance of the application. The values reported in that table were measured under a specific set of conditions that never obtain in an actual application. The effective $R_{\theta\text{JA}}$ is a critical parameter and depends on many factors such as the following:

- Power dissipation

- Air temperature
- PCB area
- Copper heatsink area
- Air flow
- Adjacent component placement

The resources found in [Table 11-1](#) can be used as a guide to estimate the $R_{\theta JA}$ for a given application environment. A typical example of $R_{\theta JA}$ versus copper board area is shown in [Figure 8-3](#). The copper area in this graph is that for each layer; the inner layers are 1 oz (35 μ m). An $R_{\theta JA}$ of 44°C/W is the approximate value for the LMZ20501 evaluation board. The efficiency found in [Equation 3](#), η , should be taken at the elevated ambient temperature. For the LMZ20501, the efficiency is approximately two to three percent lower at high temperatures. Therefore, a slightly lower value than the typical efficiency can be used in the calculation. In this way, [Equation 3](#) can be used to estimate the maximum output current for a given ambient, or to estimate the maximum ambient for a given load current.

A typical curve of maximum load current versus ambient temperature is shown in [Figure 8-4](#). This graph assumes a $R_{\theta JA}$ of 44°C/W and an input voltage of 5 V.

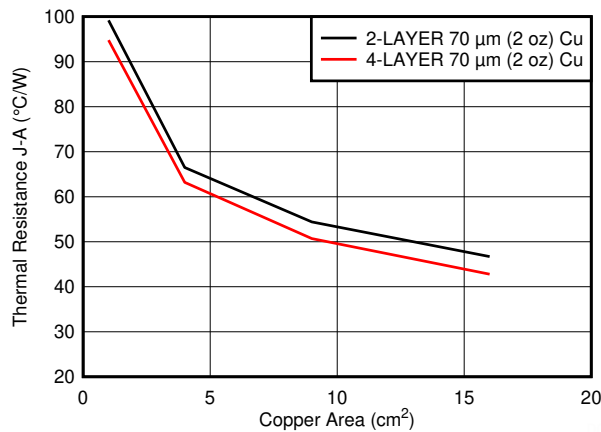

Figure 8-3. $R_{\theta JA}$ Versus Copper Board Area

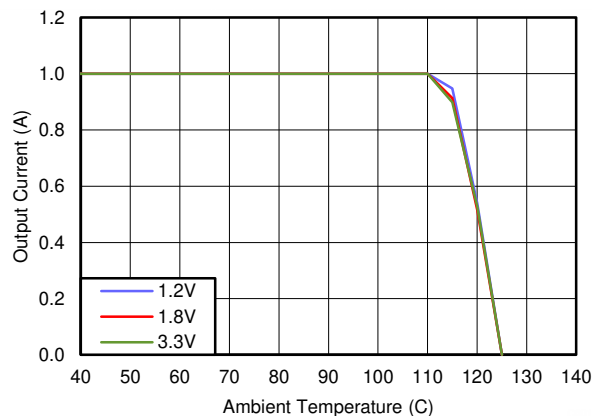

Figure 8-4. Maximum Output Current Versus Ambient Temperature, $R_{\theta JA} = 44^\circ\text{C/W}$, $V_{IN} = 5\text{ V}$

8.2.1.6 Options

The circuit in [Figure 8-2](#) highlights the use of the features of the LMZ20501. The PG output is open drain, and requires a pullup resistor to a logic supply that is commensurate with the system logic voltage levels. If a reset function is not needed, the PG pin should be left open. The EN and MODE inputs are digital inputs, requiring only simple logic levels for proper operation. If the system does not need to control these features, the inputs should be connected to either VIN or GND, as appropriate. See [Section 7.3](#) for details.

8.2.2 Application Curves

The following specifications apply to the circuit found in [Figure 8-1](#) or [Figure 8-2](#) with the appropriate modifications from [Table 8-1](#). **These parameters are not tested and represent typical performance only.** Unless otherwise stated the following conditions apply: $T_A = 25^\circ\text{C}$.

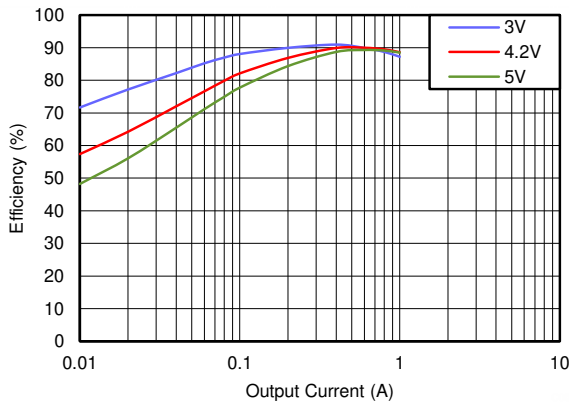

$V_{OUT} = 1.8\text{ V}$

Figure 8-5. Efficiency

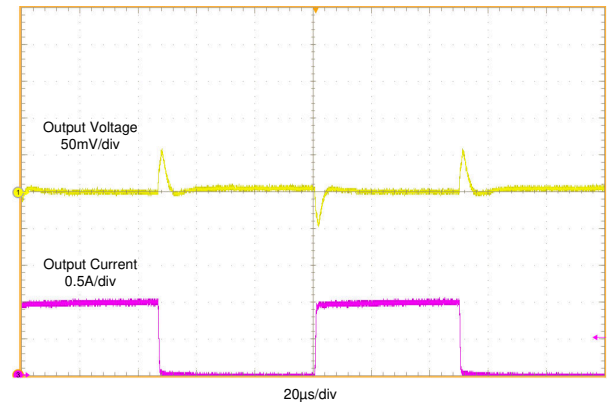

$V_{OUT} = 1.8\text{ V}$

$V_{IN} = 4.2\text{ V}$

Figure 8-6. Load Transient In PWM

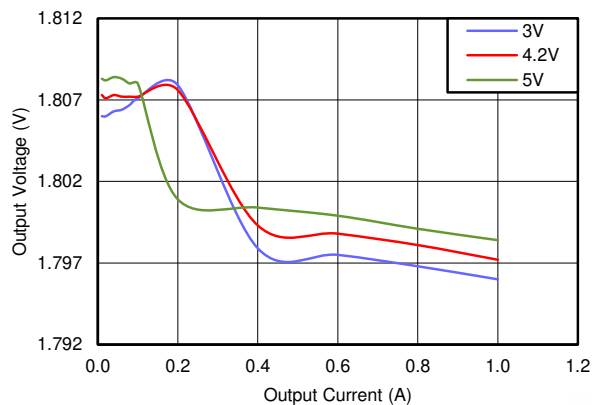

$V_{OUT} = 1.8\text{ V}$

Figure 8-7. Regulation, AUTO Mode

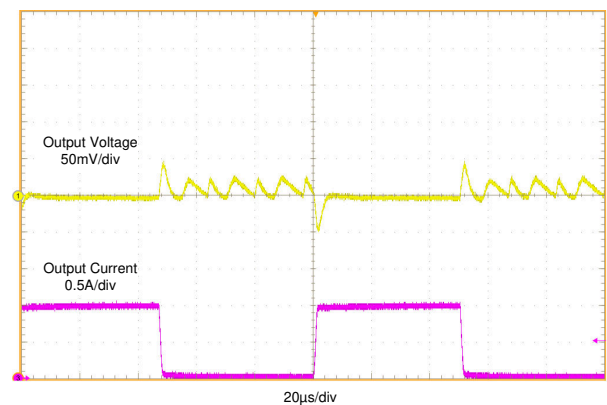

$V_{OUT} = 1.8\text{ V}$

$V_{IN} = 4.2\text{ V}$

Figure 8-8. Load Transient In AUTO Mode

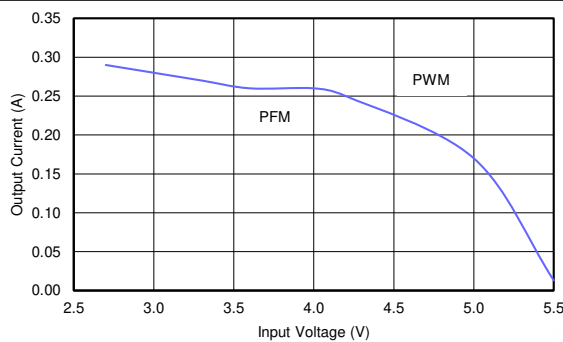

$V_{OUT} = 1.8\text{ V}$

Figure 8-9. AUTO Mode Thresholds

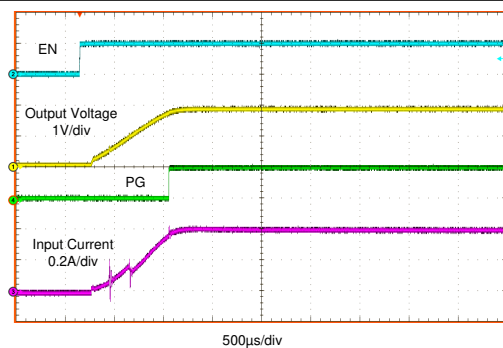

$V_{OUT} = 1.8\text{ V}$

$V_{IN} = 5\text{ V}$

$I_{OUT} = 1\text{ A}$

Figure 8-10. Start-Up

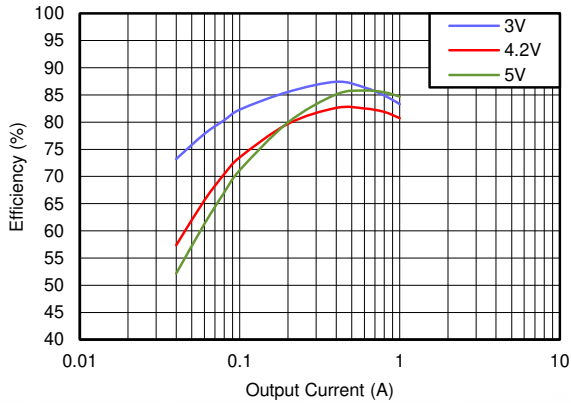

$V_{OUT} = 1.2\text{ V}$

Figure 8-11. Efficiency

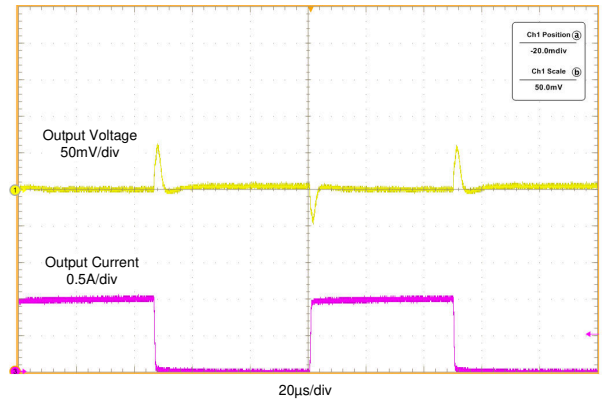

$V_{OUT} = 1.2\text{ V}$ $V_{IN} = 4.2\text{ V}$

Figure 8-12. Load Transients In PWM

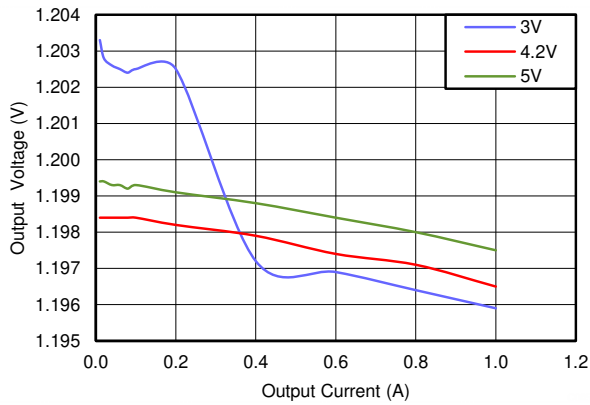

$V_{OUT} = 1.2\text{ V}$

Figure 8-13. Regulation, AUTO Mode

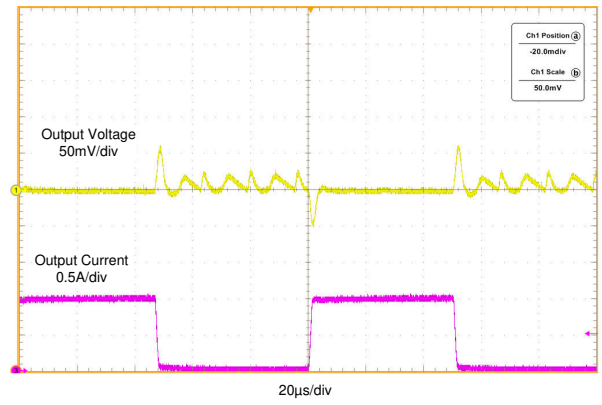

$V_{OUT} = 1.2\text{ V}$ $V_{IN} = 4.2\text{ V}$

Figure 8-14. Load Transients In AUTO Mode

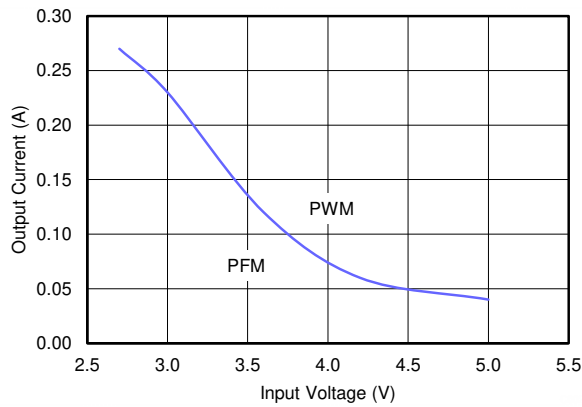

$V_{OUT} = 1.2\text{ V}$

Figure 8-15. AUTO Mode Thresholds

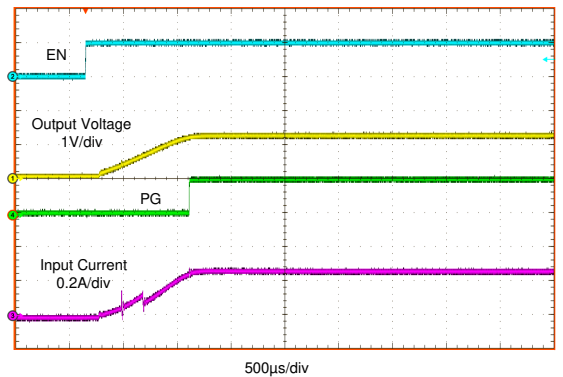

$V_{OUT} = 1.2\text{ V}$ $V_{IN} = 5\text{ V}$ $I_{OUT} = 1\text{ A}$

Figure 8-16. Start-Up

LMZ20501

SNVS874E – AUGUST 2012 – REVISED SEPTEMBER 2021

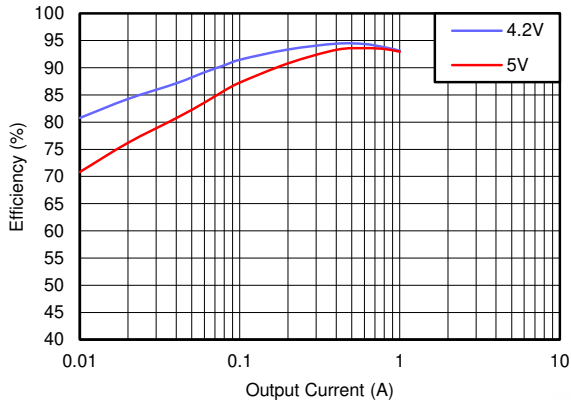

$V_{OUT} = 3.3\text{ V}$

Figure 8-17. Efficiency

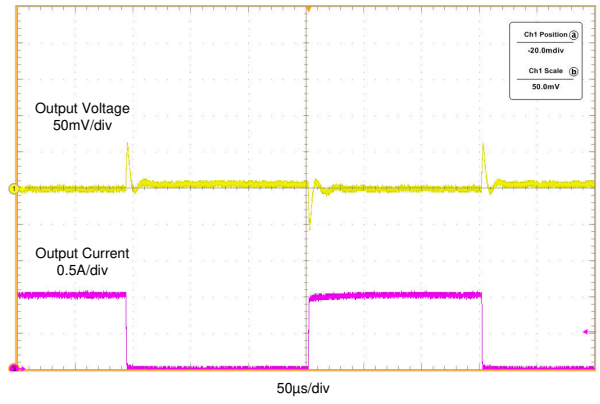

$V_{OUT} = 3.3\text{ V}$ $V_{IN} = 5\text{ V}$

Figure 8-18. Load Transients In PWM Mode

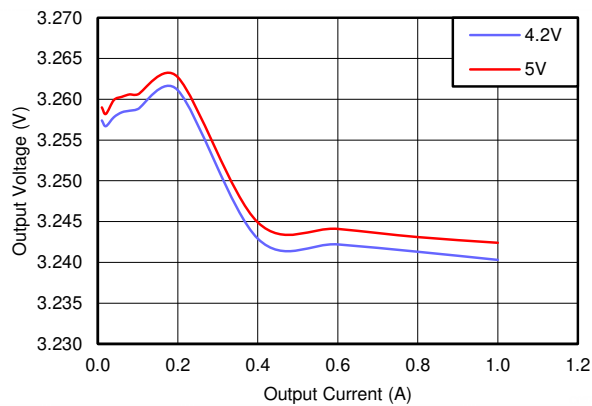

$V_{OUT} = 3.3\text{ V}$

Figure 8-19. Regulation, AUTO Mode

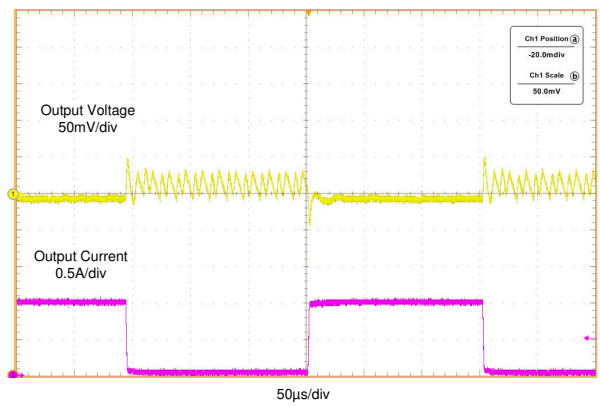

$V_{OUT} = 3.3\text{ V}$ $V_{IN} = 5\text{ V}$

Figure 8-20. Load Transients In AUTO Mode

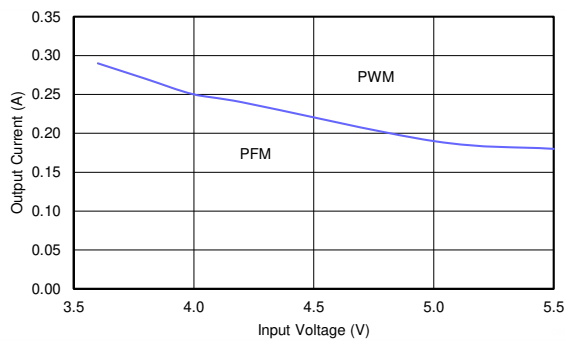

$V_{OUT} = 3.3\text{ V}$

Figure 8-21. AUTO Mode Thresholds

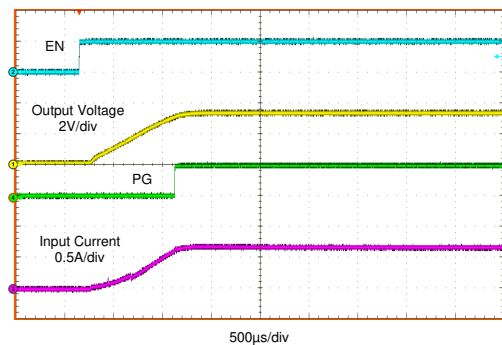

$V_{OUT} = 3.3\text{ V}$ $V_{IN} = 5\text{ V}$ $I_{OUT} = 1\text{ A}$

Figure 8-22. Start-Up

8.3 Do's and Don'ts

- **Don't:** Exceed the [Absolute Maximum Ratings](#).
- **Don't:** Exceed the [ESD Ratings](#).
- **Don't:** Exceed the [Recommended Operating Conditions](#).
- **Don't:** Allow the EN or MODE input to float.
- **Don't:** Allow the voltage on the EN or MODE input to exceed the voltage on the VIN pin.
- **Don't:** Allow the output voltage to exceed the input voltage.
- **Don't:** Use the thermal data given in the [Thermal Information](#) table to design your application.
- **Do:** Follow all of the guidelines and suggestions found in this data sheet before committing your design to production. TI Application Engineers are ready to help critique your design and PCB layout to help make your project a success.
- **Do:** Refer to the helpful documents found in [Table 11-1](#) and [Table 11-2](#)

9 Power Supply Recommendations

The characteristics of the input supply must be compatible with the [Absolute Maximum Ratings](#) and [Recommended Operating Conditions](#) found in this data sheet. In addition, the input supply must be capable of delivering the required input current to the loaded regulator. The average input current can be estimated with [Equation 4](#)

$$I_{IN} = \frac{V_{OUT} \cdot I_{OUT}}{V_{IN} \cdot \eta} \quad (4)$$

If the regulator is connected to the input supply through long wires or PCB traces, special care is required to achieve good performance. The parasitic inductance and resistance of the input cables can have an adverse effect on the operation of the regulator. The parasitic inductance, in combination with the low ESR ceramic input capacitors, can form an under-damped resonant circuit. This circuit can cause overvoltage transients at the VIN pin, each time the input supply is cycled on and off. The parasitic resistance will cause the voltage at the VIN pin to dip when the load on the regulator is switched on, or exhibits a transient. If the regulator is operating close to the minimum input voltage, this dip can cause the device to shutdown, reset, or both. The best way to solve these kinds of issues is to reduce the distance from the input supply to the regulator, use an aluminum or tantalum input capacitor in parallel with the ceramics, or both. The moderate ESR of these types of capacitors will help to damp the input resonant circuit and reduce any voltage overshoots. A value in the range of 20 μ F to 100 μ F is usually sufficient to provide input damping and help to hold the input voltage steady during large load transients.

Sometimes, for other system considerations, an input filter is used in front of the regulator module. This can lead to instability, as well as some of the effects mentioned above, unless it is designed carefully. The following user guide provides helpful suggestions when designing an input filter for any switching regulator: [AN-2162 Simple Success With Conducted EMI From DC-DC Converters Application Report](#).

In some cases, a Transient Voltage Suppressor (TVS) is used on the input of regulators. One class of this device has a "snap-back" V-I characteristic (thyristor type). The use of a device with this type of characteristic is not recommended. When the TVS "fires", the clamping voltage drops to a very low value. If this holding voltage is less than the output voltage of the regulator, the output capacitors will be discharged through the regulator back to the input. This uncontrolled current flow could damage the regulator.

10 Layout

10.1 Layout Guidelines

The PCB layout of any DC-DC converter is critical to the optimal performance of the design. Bad PCB layout can disrupt the operation of an otherwise good schematic design. Even if the converter regulates correctly, bad PCB layout can mean the difference between a robust design and one that cannot be mass produced. Furthermore, the EMI performance of the regulator is dependent on the PCB layout, to a great extent. In a buck converter, the most critical PCB feature is the loop formed by the input capacitor and the module ground, as shown in [Figure 10-1](#). This loop carries fast transient currents that can cause large transient voltages when reacting with the trace inductance. These unwanted transient voltages will disrupt the proper operation of the converter. Because of this, the traces in this loop should be wide and short, and the loop area as small as possible to reduce the parasitic inductance. [Figure 10-2](#) shows a recommended layout for the critical components of the LMZ20501; the top side metal is shown in red. This PCB layout is a good guide for any specific application. The following important guidelines should also be followed:

1. **Place the input capacitor C_{IN} as close as possible to the VIN and GND terminals.** VIN (pin 8) and GND (pin 6) are on the same side of the module, simplifying the input capacitor placement.
2. **Place the feedback divider as close as possible to the FB pin on the module.** The divider and C_{FF} should be close to the module, while the length of the trace from VOUT to the divider can be somewhat longer. However, this latter trace should not be routed near any noise sources that can capacitively couple to the FB input.
3. **Connect the EP pad to the GND plane.** This pad acts as a heat-sink connection and a ground connection for the module. It must be solidly connected to a ground plane. The integrity of this connection has a direct bearing on the effective $R_{\theta JA}$.
4. **Provide enough PCB area for proper heat-sinking.** As stated in [Section 8.2.1.5](#), enough copper area must be used to provide a low $R_{\theta JA}$, commensurate with the maximum load current and ambient temperature. The top and bottom PCB layers should be made with two ounce copper; and no less than one ounce.
5. **The resources in [Table 11-2](#) provide additional important guidelines.**

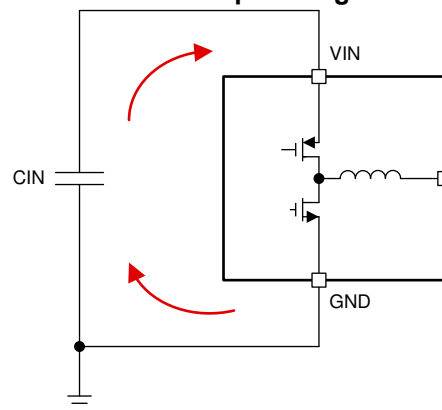

Figure 10-1. Current Loops With Fast Transient Currents

10.2 Layout Example

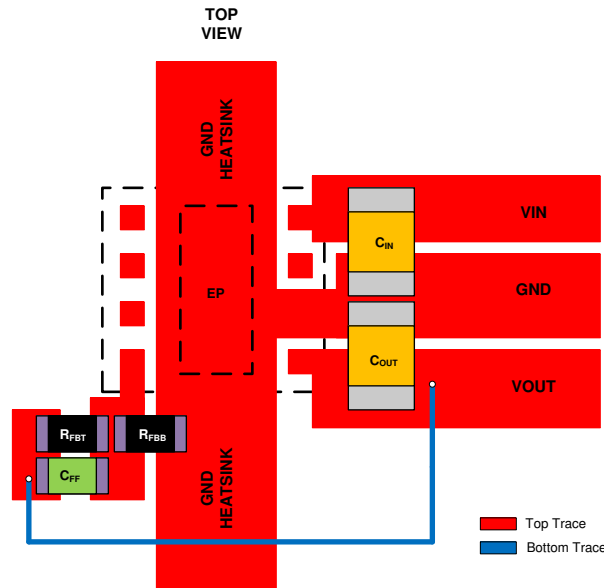

Figure 10-2. Example PCB Layout

10.2.1 Soldering Information

Proper operation of the LMZ20501 requires that it be correctly soldered to the PCB. This is especially true regarding the EP. This pad acts as a quiet ground reference for the device and a heatsink connection. Use the following recommendations when utilizing machine placement of the device:

- Dimension of area for pickup: 2 mm × 2.5 mm
- Use a nozzle size of less than 1.3 mm in diameter, so that the head does not touch the outer area of the package.
- Use a soft tip pick-and-place head.
- Add 0.05 mm to the component thickness so that the device will be released 0.05 mm into the solder paste without putting pressure or splashing the solder paste.
- Slow the pick arm when picking the part from the tape and reel carrier and when depositing the device on the board.
- If the machine releases the component by force, use the minimum force and no more than 3 N.
- For PCBs with surface mount components on both sides, it is suggested to put the LMZ20501 on the top side. In case the application requires bottom side placement, a re-flow fixture can be required to protect the module during the second reflow.

In addition, please follow the important guidelines found in the [AN-1187 Leadless Leadframe Package \(LLP\) Application Report](#). The curves in [Figure 10-3](#) and [Figure 10-4](#) show typical soldering temperature profiles.

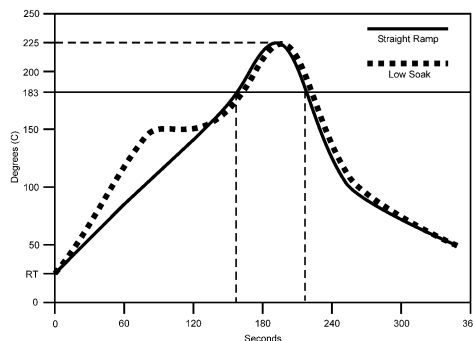

Figure 10-3. Typical Re-flow Profile Eutectic (63sn/37pb) Solder Paste

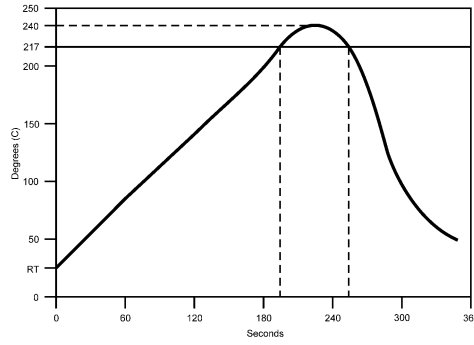

Figure 10-4. Typical Re-flow Profile Lead-Free (Sca305 Or Sac405) Solder Paste

11 Device and Documentation Support

11.1 Device Support

11.1.1 Third-Party Products Disclaimer

TI'S PUBLICATION OF INFORMATION REGARDING THIRD-PARTY PRODUCTS OR SERVICES DOES NOT CONSTITUTE AN ENDORSEMENT REGARDING THE SUITABILITY OF SUCH PRODUCTS OR SERVICES OR A WARRANTY, REPRESENTATION OR ENDORSEMENT OF SUCH PRODUCTS OR SERVICES, EITHER ALONE OR IN COMBINATION WITH ANY TI PRODUCT OR SERVICE.

11.1.2 Development Support

11.1.2.1 Custom Design With WEBENCH® Tools

[Click here](#) to create a custom design using the LMZ20501 device with the WEBENCH® Power Designer.

1. Start by entering the input voltage (V_{IN}), output voltage (V_{OUT}), and output current (I_{OUT}) requirements.
2. Optimize the design for key parameters such as efficiency, footprint, and cost using the optimizer dial.
3. Compare the generated design with other possible solutions from Texas Instruments.

The WEBENCH Power Designer provides a customized schematic along with a list of materials with real-time pricing and component availability.

In most cases, these actions are available:

- Run electrical simulations to see important waveforms and circuit performance
- Run thermal simulations to understand board thermal performance
- Export customized schematic and layout into popular CAD formats
- Print PDF reports for the design, and share the design with colleagues

Get more information about WEBENCH tools at www.ti.com/WEBENCH.

11.2 Documentation Support

11.2.1 Related Documentation

For related documentation see the following:

Table 11-1. Resources For Estimating $R_{\theta JA}$

TITLE	LINK
AN-2020 <i>Thermal Design By Insight, Not Hindsight</i>	SNVA419
AN-2026 <i>The Effect of PCB Design on the Thermal Performance of SIMPLE SWITCHER Power Modules</i>	SNVA424
AN-1520 <i>A Guide to Board Layout for Best Thermal Resistance for Exposed Packages</i>	SNVA183
AN-1187 <i>Leadless Lead-frame Package (LLP)</i>	SNOA401
SPRA953B <i>Semiconductor and IC Package Thermal Metrics</i>	SPRA953

Table 11-2. PCB Layout Resources

TITLE	LINK
AN-1149 <i>Layout Guidelines for Switching Power Supplies</i>	SNVA021
AN-1229 <i>SIMPLE SWITCHER PCB Layout Guidelines</i>	SNVA054
<i>Constructing Your Power Supply- Layout Considerations</i>	SLUP230

11.3 Receiving Notification of Documentation Updates

To receive notification of documentation updates, navigate to the device product folder on ti.com. Click on *Subscribe to updates* to register and receive a weekly digest of any product information that has changed. For change details, review the revision history included in any revised document.

11.4 Support Resources

TI E2E™ [support forums](#) are an engineer's go-to source for fast, verified answers and design help — straight from the experts. Search existing answers or ask your own question to get the quick design help you need.

Linked content is provided "AS IS" by the respective contributors. They do not constitute TI specifications and do not necessarily reflect TI's views; see TI's [Terms of Use](#).

11.5 Trademarks

TI E2E™ is a trademark of Texas Instruments.

WEBENCH® and WebTherm® are registered trademarks of Texas Instruments.

All trademarks are the property of their respective owners.

11.6 Electrostatic Discharge Caution



This integrated circuit can be damaged by ESD. Texas Instruments recommends that all integrated circuits be handled with appropriate precautions. Failure to observe proper handling and installation procedures can cause damage.

ESD damage can range from subtle performance degradation to complete device failure. Precision integrated circuits may be more susceptible to damage because very small parametric changes could cause the device not to meet its published specifications.

11.7 Glossary

[TI Glossary](#) This glossary lists and explains terms, acronyms, and definitions.

12 Mechanical, Packaging, and Orderable Information

The following pages include mechanical, packaging, and orderable information. This information is the most current data available for the designated devices. This data is subject to change without notice and revision of this document. For browser-based versions of this data sheet, refer to the left-hand navigation.

12.1 Tape and Reel Information

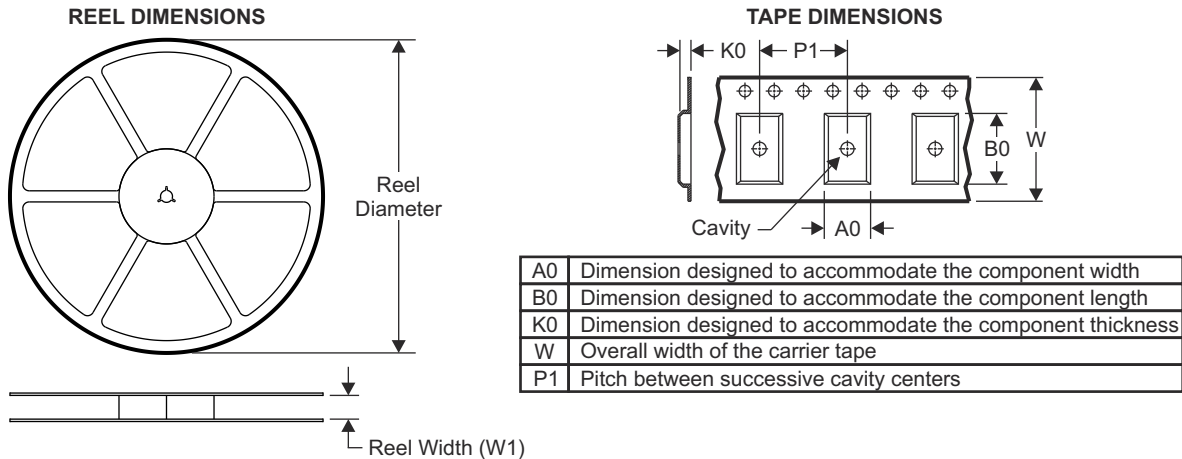

QUADRANT ASSIGNMENTS FOR PIN 1 ORIENTATION IN TAPE

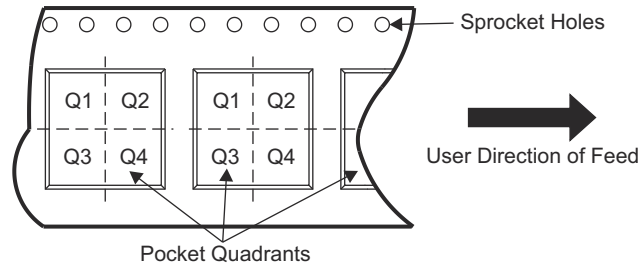

Device	Package Type	Package Drawing	Pins	SPQ	Reel Diameter (mm)	Reel Width W1 (mm)	A0 (mm)	B0 (mm)	K0 (mm)	P1 (mm)	W (mm)	Pin1 Quadrant
LMZ20501SILR	uSiP	SIL	8	3000	330.0	12.4	3.75	3.75	2.2	8.0	12.0	Q2
LMZ20501SILT	uSiP	SIL	8	250	178.0	13.2	3.75	3.75	2.2	8.0	12.0	Q2

TAPE AND REEL BOX DIMENSIONS

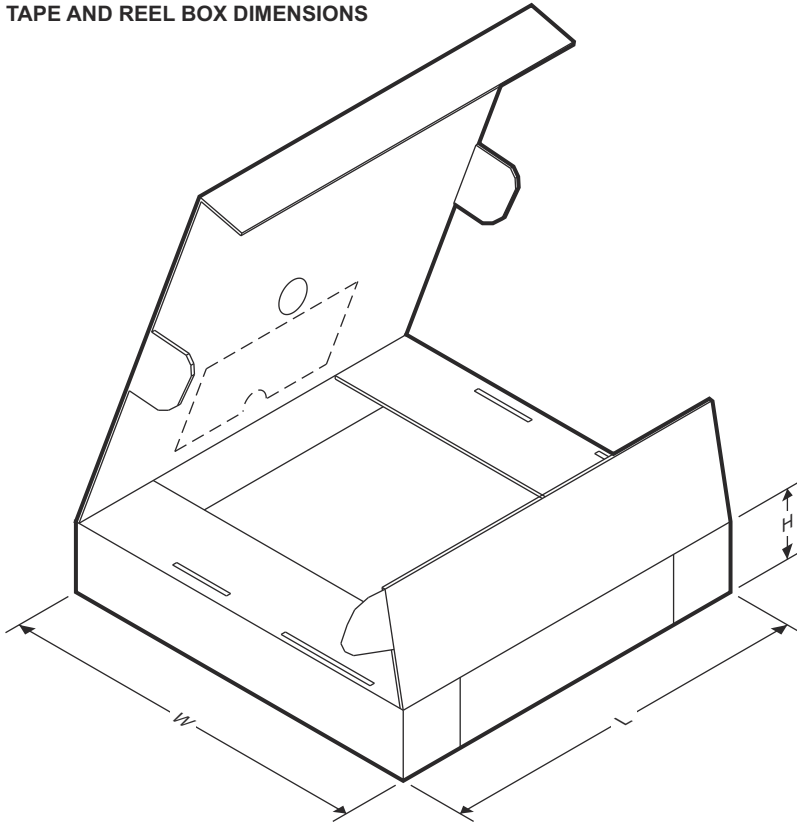

Device	Package Type	Package Drawing	Pins	SPQ	Length (mm)	Width (mm)	Height (mm)
LMZ20501SILR	uSiP	SIL	8	3000	383.0	353.0	58.0
LMZ20501SILT	uSiP	SIL	8	250	223.0	194.0	35.0

PACKAGING INFORMATION

Orderable Device	Status (1)	Package Type	Package Drawing	Pins	Package Qty	Eco Plan (2)	Lead finish/ Ball material (6)	MSL Peak Temp (3)	Op Temp (°C)	Device Marking (4/5)	Samples
LMZ20501SILR	ACTIVE	uSiP	SIL	8	3000	RoHS & Green	NIAU	Level-3-260C-168 HR	-40 to 125	1501 7543 EB	Samples
LMZ20501SILT	ACTIVE	uSiP	SIL	8	250	RoHS & Green	NIAU	Level-3-260C-168 HR	-40 to 125	1501 7543 EB	Samples

(1) The marketing status values are defined as follows:

ACTIVE: Product device recommended for new designs.

LIFEBUY: TI has announced that the device will be discontinued, and a lifetime-buy period is in effect.

NRND: Not recommended for new designs. Device is in production to support existing customers, but TI does not recommend using this part in a new design.

PREVIEW: Device has been announced but is not in production. Samples may or may not be available.

OBSOLETE: TI has discontinued the production of the device.

(2) **RoHS:** TI defines "RoHS" to mean semiconductor products that are compliant with the current EU RoHS requirements for all 10 RoHS substances, including the requirement that RoHS substance do not exceed 0.1% by weight in homogeneous materials. Where designed to be soldered at high temperatures, "RoHS" products are suitable for use in specified lead-free processes. TI may reference these types of products as "Pb-Free".

RoHS Exempt: TI defines "RoHS Exempt" to mean products that contain lead but are compliant with EU RoHS pursuant to a specific EU RoHS exemption.

Green: TI defines "Green" to mean the content of Chlorine (Cl) and Bromine (Br) based flame retardants meet JS709B low halogen requirements of <=1000ppm threshold. Antimony trioxide based flame retardants must also meet the <=1000ppm threshold requirement.

(3) MSL, Peak Temp. - The Moisture Sensitivity Level rating according to the JEDEC industry standard classifications, and peak solder temperature.

(4) There may be additional marking, which relates to the logo, the lot trace code information, or the environmental category on the device.

(5) Multiple Device Markings will be inside parentheses. Only one Device Marking contained in parentheses and separated by a "~" will appear on a device. If a line is indented then it is a continuation of the previous line and the two combined represent the entire Device Marking for that device.

(6) Lead finish/Ball material - Orderable Devices may have multiple material finish options. Finish options are separated by a vertical ruled line. Lead finish/Ball material values may wrap to two lines if the finish value exceeds the maximum column width.

Important Information and Disclaimer:The information provided on this page represents TI's knowledge and belief as of the date that it is provided. TI bases its knowledge and belief on information provided by third parties, and makes no representation or warranty as to the accuracy of such information. Efforts are underway to better integrate information from third parties. TI has taken and continues to take reasonable steps to provide representative and accurate information but may not have conducted destructive testing or chemical analysis on incoming materials and chemicals. TI and TI suppliers consider certain information to be proprietary, and thus CAS numbers and other limited information may not be available for release.

In no event shall TI's liability arising out of such information exceed the total purchase price of the TI part(s) at issue in this document sold by TI to Customer on an annual basis.

TAPE AND REEL INFORMATION

QUADRANT ASSIGNMENTS FOR PIN 1 ORIENTATION IN TAPE

*All dimensions are nominal

Device	Package Type	Package Drawing	Pins	SPQ	Reel Diameter (mm)	Reel Width W1 (mm)	A0 (mm)	B0 (mm)	K0 (mm)	P1 (mm)	W (mm)	Pin1 Quadrant
LMZ20501SILR	uSiP	SIL	8	3000	330.0	12.4	3.75	3.75	2.2	8.0	12.0	Q2
LMZ20501SILT	uSiP	SIL	8	250	178.0	13.2	3.75	3.75	2.2	8.0	12.0	Q2

TAPE AND REEL BOX DIMENSIONS

*All dimensions are nominal

Device	Package Type	Package Drawing	Pins	SPQ	Length (mm)	Width (mm)	Height (mm)
LMZ20501SILR	uSiP	SIL	8	3000	383.0	353.0	58.0
LMZ20501SILT	uSiP	SIL	8	250	223.0	194.0	35.0

IMPORTANT NOTICE AND DISCLAIMER

TI PROVIDES TECHNICAL AND RELIABILITY DATA (INCLUDING DATA SHEETS), DESIGN RESOURCES (INCLUDING REFERENCE DESIGNS), APPLICATION OR OTHER DESIGN ADVICE, WEB TOOLS, SAFETY INFORMATION, AND OTHER RESOURCES "AS IS" AND WITH ALL FAULTS, AND DISCLAIMS ALL WARRANTIES, EXPRESS AND IMPLIED, INCLUDING WITHOUT LIMITATION ANY IMPLIED WARRANTIES OF MERCHANTABILITY, FITNESS FOR A PARTICULAR PURPOSE OR NON-INFRINGEMENT OF THIRD PARTY INTELLECTUAL PROPERTY RIGHTS.

These resources are intended for skilled developers designing with TI products. You are solely responsible for (1) selecting the appropriate TI products for your application, (2) designing, validating and testing your application, and (3) ensuring your application meets applicable standards, and any other safety, security, regulatory or other requirements.

These resources are subject to change without notice. TI grants you permission to use these resources only for development of an application that uses the TI products described in the resource. Other reproduction and display of these resources is prohibited. No license is granted to any other TI intellectual property right or to any third party intellectual property right. TI disclaims responsibility for, and you will fully indemnify TI and its representatives against, any claims, damages, costs, losses, and liabilities arising out of your use of these resources.

TI's products are provided subject to [TI's Terms of Sale](#) or other applicable terms available either on [ti.com](https://www.ti.com) or provided in conjunction with such TI products. TI's provision of these resources does not expand or otherwise alter TI's applicable warranties or warranty disclaimers for TI products.

TI objects to and rejects any additional or different terms you may have proposed.

Mailing Address: Texas Instruments, Post Office Box 655303, Dallas, Texas 75265
Copyright © 2023, Texas Instruments Incorporated