

■ Specifications :

- Voltage rating: 250V AC / DC
- Current rating: 3A AC / DC
- Withstanding voltage: 800V AC/minute
- Temperature range: -25°C~+85°C
- Insulation resistance: ≥1000M Ω
- Contact resistance: ≤10mΩ
- After environmental testing : ≤20mΩ

X2581 W V-XX - N0 SN

- ① Series No.
- ② Category : W-WAFER
- ③ Wedding Board Angle : V-Stright 180°
- ④ Row No.-Pin No.: XX-02P~15P
- ⑤ Material : N0-PA66;46-PA46 94V-0
- ⑥ Plating Category: Sn-Bright Tin Plating

Poles	Dimensions(mm)		Poles	Dimensions(mm)	
	A	B		A	B
02	2.50	7.50	12	27.50	32.50
03	5.00	10.00	13	30.00	35.00
04	7.50	12.50	14	32.50	37.50
05	10.00	15.00	15	35.00	40.00
06	12.50	17.50			
07	15.00	20.00			
08	17.50	22.50			
09	20.00	25.00			
10	22.50	27.50			
11	25.00	30.00			

广东星坤科技股份有限公司
 XKB INDUSTRIAL PRECISION CO., LIMITED

生效

MARK	DESCRIPTION	DATE	REVISED	APPROVED
ΔX				
ΔX				
ΔX				

日期

REVISIONS

www.xk-dg.cn www.helloxkb.com www.helloxkb.cn

ANGLAR	±5°
L ≤ 4	±0.2
4 < L ≤ 16	±0.3
16 < L ≤ 63	±0.4
L > 63	±0.5

UNSPECIFIED TOLERANCES

DSND	DATE	SCALE: N/A	MODEL TYPE: X2581WV-XX-N0SN
DWN	DATE	VIEW:	PART NO.: 2.5mm Crimp Style Connectors
CHKD	DATE	UNIT: mm/in	DWG NO.:
APPD	DATE	SIZE: A4	
XKB INDUSTRIAL PRECISION CO., LIMITED			WEIGHT 1.0g
			SHEET 1/1
			REVISION A0

文件工程章

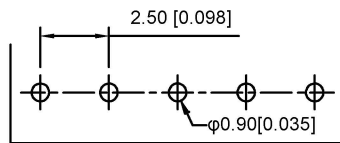
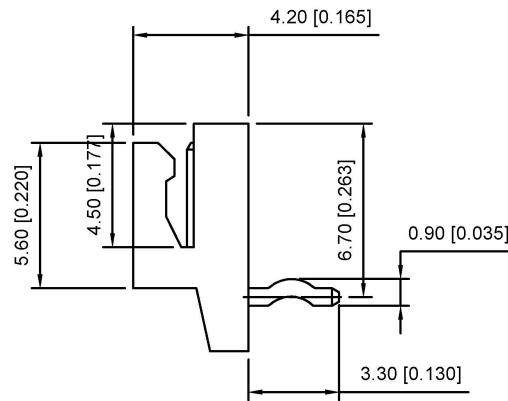
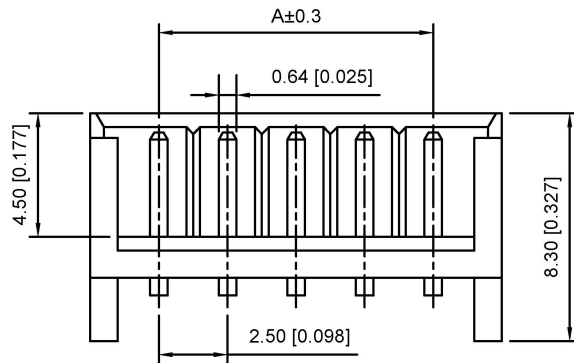
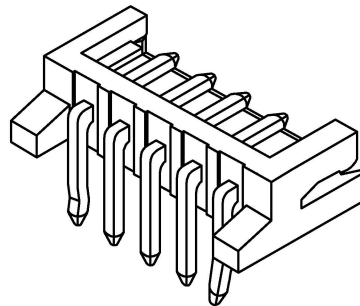
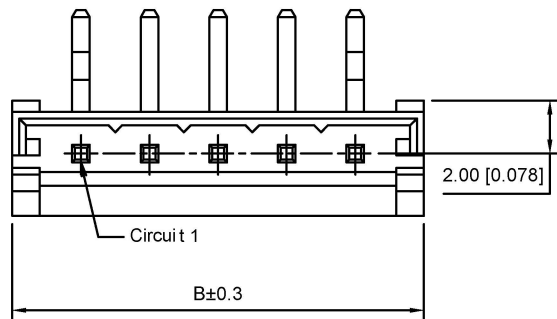

■ Specifications :

- Voltage rating: 250V AC / DC
- Current rating: 3A AC / DC
- Withstanding voltage: 800V AC/minute
- Temperature range: -25°C~+85°C
- Insulation resistance: $\geq 1000M \Omega$
- Contact resistance: $\leq 10m\Omega$
- After environmental testing: $\leq 20m\Omega$

X2581 W R-XX - N0 SN

- ① Series No.
- ② Category : W-WAFER
- ③ Wedding Board Angle : R-S tright 90°
- ④ Row No.-Pin No.: XX-02P~16P
- ⑤ Material : N0-PA66;46-PA46 94V-0
- ⑥ Plating Category: Sn-Bright Tin Plating

Poles	Dimensions(mm)		Poles	Dimensions(mm)	
	A	B		A	B
02	2.50	7.50	12	27.50	32.50
03	5.00	10.00	13	30.00	35.00
04	7.50	12.50	14	32.50	37.50
05	10.00	15.00	15	35.00	40.00
06	12.50	17.50	16	37.50	42.50
07	15.00	20.00			
08	17.50	22.50			
09	20.00	25.00			
10	22.50	27.50			
11	25.00	30.00			

广东星坤科技股份有限公司

Recommend PCB Layout

生效

MARK	DESCRIPTION	DATE	REVISED	APPROVED
ΔX				
ΔX				
ΔX				

日期

REVISIONS

www.xk-dg.cn www.helloxkb.com www.helloxkb.cn

ANGLAR	±5°
L ≤ 4	±0.2
4 < L ≤ 16	±0.3
16 < L ≤ 63	±0.4
L > 63	±0.5

UNSPECIFIED TOLERANCES

DSND	DATE	SCALE: N/A	MODEL TYPE:
DWN	DATE	VIEW:	X2581WR-XX-N0SN
CHKD	DATE	UNIT: mm/in	PART NO.: 2.5mm Crimp Style Connectors
APPD	DATE	SIZE: A4	DWG NO.:
XKB INDUSTRIAL PRECISION CO., LIMITED			WEIGHT: 1.0g
			SHEET: 1/1
			REVISION: A0

文件工程章

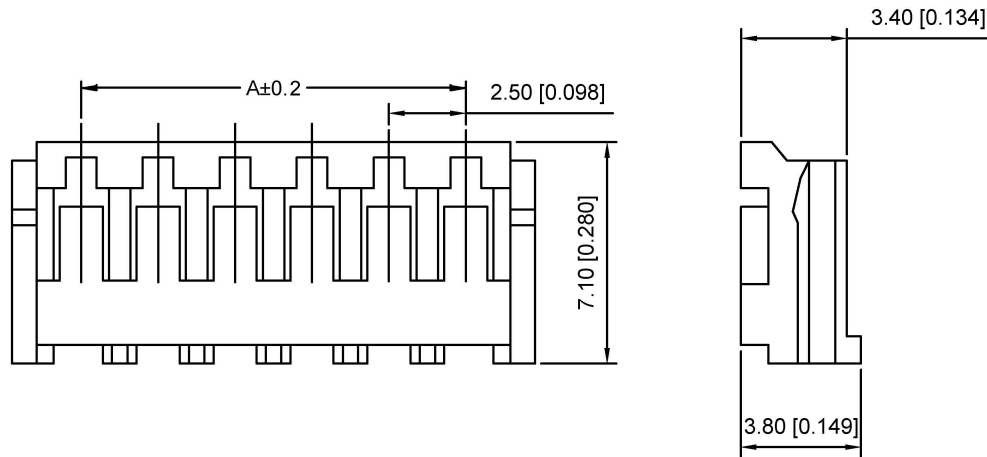
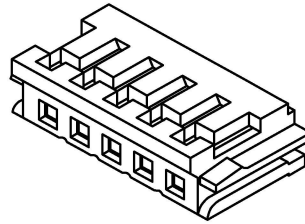
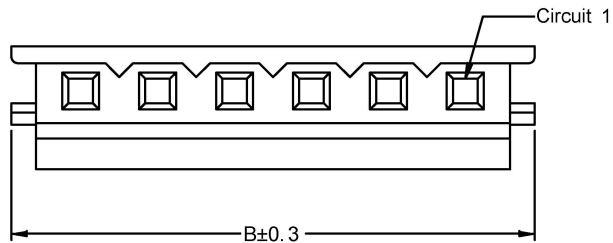

Specifications :

- Voltage rating: 250V AC / DC
- Current rating: 3A AC / DC
- Withstanding voltage: 800V AC/minute
- Temperature range: -25°C~+85°C
- Insulation resistance: ≥1000MΩ
- Contact resistance: ≤10mΩ
- After environmental testing : ≤20mΩ

X2581 H X-XX X-N0 XX

① ② ③ ④ ⑤ ⑥ ⑦

- ① Series No.
- ② Category : H-HSG
- ③ Appearance type : Blank-Ordinary
- ④ Row No.-Pin No.: XX-Single Row
- ⑤ Plug the Pin & Special No. Blank-Ordinary
- ⑥ Material : N0-PA66 94V-0
- ⑦ Color: Blank : Natural Color

Poles	A	B
02	2.50	7.00
03	5.00	9.50
04	7.50	12.00
05	10.00	14.50
06	12.50	17.00
07	15.00	19.50
08	17.50	22.00
09	20.00	24.50
10	22.50	27.00
11	25.00	29.50
12	27.50	32.00
13	30.00	34.50
14	32.50	37.00
15	35.00	39.50

X2581H-XX-N0	Nylon 66 UL 94V-0	X2581T	X2581W
PART NO	Material	Suitable XKB Terminal	Suitable XKB Terminal

DSND	DATE	SCALE: N/A	MODEL TYPE: X2581H-XX-N0
DWN	DATE	VIEW:	PART NO.: 2.5mm Crimp Style Connectors
CHKD	DATE	UNIT: mm/in	DWG NO.: X2581H-XX-N0
APPD	DATE	SIZE: A4	
XKB INDUSTRIAL PRECISION CO., LIMITED			WEIGHT 1.0g
			SHEET 1/1
			REVISION A0

广东星坤科技股份有限公司

生效

MARK	DESCRIPTION	DATE	REVISED	APPROVED
ΔX				
ΔX				
ΔX				

REVISIONS

www.xk-dg.cn www.helloxkb.com www.helloxkb.cn

ANGLAR	±5°
L ≤ 4	±0.2
4 < L ≤ 16	±0.3
16 < L ≤ 63	±0.4
L > 63	±0.5

UNSPECIFIED TOLERANCES

文件工程章

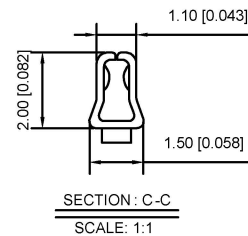
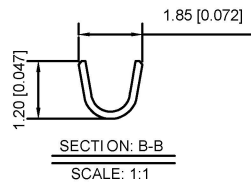
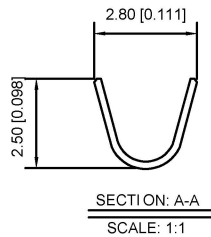
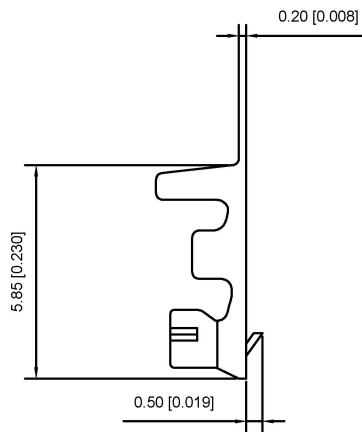
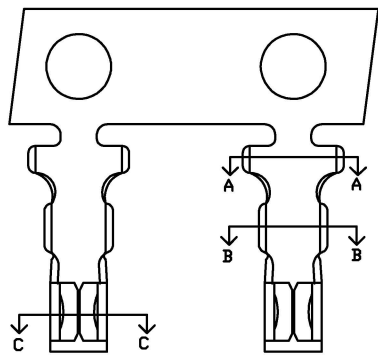

Specifications :

- Voltage rating: 250V AC / DC
- Current rating: 3A AC / DC
- Withstanding voltage: 800V AC/minute
- Temperature range: -25°C~+85°C
- Insulation resistance: $\geq 1000M\Omega$
- Contact resistance: $\leq 10m\Omega$
- After environmental testing : $\leq 20m\Omega$

X2581 T X-P SN X-X

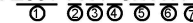

- ① Series No.
- ② Category : T-Terminal
- ③ Appearance type : Blank-Ordinary
- ④ Material: P-Phosphor bronze ; B-Brass
- ⑤ Plating Style: G**-Gold Plated Contact
 V**- All Gold-Plated
 01-Gold Flash 02-2u" 03-3u"
 05-5u" 10-10u" 15-15u"
 SN-Bright Tin Plating (70u")
 SN1-Bright Tin Plating (120u" Min).
 0-No Plating Material
 SW- Fog Tin Plating
- ⑥ Plating Method : Blank-Stamping before Plating
- ⑦ Mold No./Mark/Special No.

X2581T-PSN	Phosphor Bronze	AWG#22-3.0	1.90mm(Ma x)	Stamping Before Plating:30-50u" Ni;70- 120u"Sn	X2581H
PART NO	Material	Wire Ra n9#	Insulation O. D.	Finish	Used In XKB Housing

广东星坤科技股份有限公司

生效

ΔX	日期
ΔX	日期
ΔX	日期
MARK	DESCRIPTION

REVISIONS	DATE	REVISED	APPROVED	UNSPECIFIED TOLERANCES
-----------	------	---------	----------	------------------------

DSND	DATE	SCALE: N/A	MODEL TYPE: X2581T-PSN
DWN	DATE	VIEW:	PART NO.: 2.5mm Crimp Style Connectors
CHKD	DATE	UNIT: mm/in	DWG NO.: X2581T-PSN
APPD	DATE	SIZE: A4	WEIGHT 1.0g
XKB INDUSTRIAL PRECISION CO., LIMITED			SHEET 1/1
			REVISION A0

文件工程章

www.xk-dg.cn www.helloxkb.com www.helloxkb.cn