

Specifications:

规格:  
 Voltage rating:250V AC/DC  
 额定电压: 250V AC/DC  
 Current rating:3A AC/DC  
 额定电流: 3A AC/DC  
 Withstanding voltage:800V AC/minute  
 耐受电压:800V AC/分钟  
 Temperature range:-25℃~+85℃  
 温度范围: -25℃~+85℃  
 Insulation resistance:≥1000MΩ  
 绝缘电阻: ≥1000MΩ  
 Contact resistance:≤10mΩ  
 接触电阻: ≤10mΩ  
 After environmental testing:≤20mΩ  
 环境测试后: ≤20兆欧

X2530 W V X-2xXX X-PT SN XX

① ②③④ ⑤ ⑥⑦ ⑧ ⑨

- 1.Series No
- 2.Category:W-wafer
- 3.Welding Board Angle:V-Straight 180°
- 4.Welding Way:Blank-DIP
- 5.Row No-Pin No:2xXX-2x02P~2x32P
- 6.Plug the Pin&Special No:
- 7.Materail:PT-PBT 94V-0
- 8.Planting Category:SN-Bright tin plating
- 9.Color:Blank-natural color black

poles	Dimensions(mm)		poles	Dimensions(mm)		poles	Dimensions(mm)	
	A	B		A	B		A	B
2x02	2.54	7.62	2x13	30.48	35.56	2x24	58.42	63.50
2x03	5.08	10.16	2x14	33.02	38.10	2x25	60.96	66.04
2x04	7.62	12.70	2x15	35.56	40.64	2x26	63.50	68.58
2x05	10.16	15.24	2x16	38.10	43.18	2x27	66.04	71.12
2x06	12.70	17.78	2x17	40.64	45.72	2x28	68.58	73.66
2x07	15.24	20.32	2x18	43.18	48.26	2x29	71.12	76.20
2x08	17.78	22.86	2x19	45.72	50.80	2x30	73.66	78.74
2x09	20.32	25.40	2x20	48.26	53.34	2x31	76.20	81.28
2x10	22.86	27.94	2x21	50.80	55.88	2x32	78.74	83.82
2x11	25.40	30.48	2x22	53.34	58.42			
2x12	27.94	33.02	2x23	55.88	60.96			

X2530WV-2xXX-PTS	PBT UL 94V-0	Brass	Tin-Plated	X2530H
PART NO	Material	Material(Pin)	Finish(Pin)	Suitable XKB Terminal

广东星坤科技股份有限公司  
 Recommended PCB Layout  
 General Tolerance±0.05

生	日期					units: mm
ΔX						tolerance:
ΔX						X.X ±0.2mm
ΔX						X.XX ±0.1mm
MARK						X.XXX ±0.05mm
文件工程章	DESCRIPTION	DATE	REVISED	APPROVED		UNSPECIFIED TOLERANCES
	REVISIONS					
	www.xk-dg.cn	www.helloxkb.com	www.helloxkb.cn			

DSND	DATE	SCALE: N/A	MODEL TYPE: Wire to board connector
DWN	DATE	VIEW:	PART NO.: 2.54mm Crimp Style Connectors
CHKD	DATE	UNIT: mm/in	DWG NO.: X2530WV-2xXX-PTS
APPD	DATE	SIZE: A4	WEIGHT 1.0g
KKB INDUSTRIAL PRECISION CO., LIMITED			SHEET 1/1
			REVISION A0

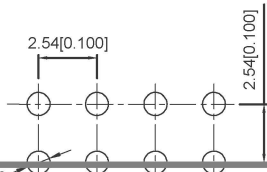
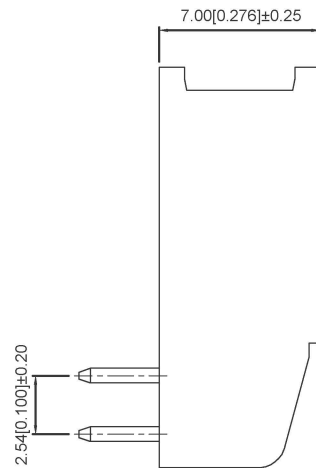
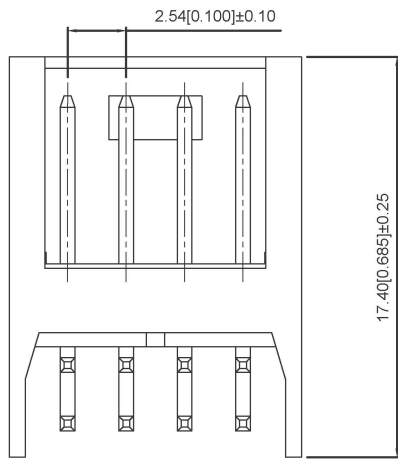
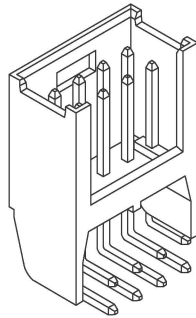
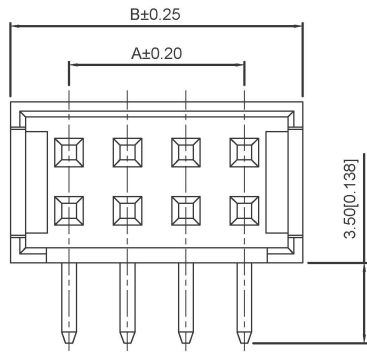

**Specifications:**

规格:  
**Voltage rating:**250V AC/DC  
 额定电压: 250V AC/DC  
**Current rating:**3A AC/DC  
 额定电流: 3A AC/DC  
**Withstanding voltage:**800V AC/minute  
 耐受电压:800V AC/分钟  
**Temperature range:**-25°C~+85°C  
 温度范围: -25°C~+85°C  
**Insulation resistance:**≥1000MΩ  
 绝缘电阻: ≥1000MΩ  
**Contact resistance:**≤10mΩ  
 接触电阻: ≤10mΩ  
**After environmental testing:**≤20mΩ  
 环境测试: ≤20兆欧

**X2530 W R X-2xXX X-PT SN XX**

① ②③④ ⑤ ⑥⑦ ⑧ ⑨

1. Series No
2. Category:W-wafer
3. Welding Board Angle:R-Right Angle 90°
4. Welding Way:Blank-DIP
5. Row No-Pin No:2xXX-2x02P~2x32P
6. Plug the Pin&Special No:
7. Materail:PT-PBT 94V-0
8. Planting Category:SN-Bright tin plating
9. Color:Blank-natural color black

poles	Dimensions(mm)		poles	Dimensions(mm)		poles	Dimensions(mm)	
	A	B		A	B		A	B
2x02	2.54	7.62	2x13	30.48	35.56	2x24	58.42	63.50
2x03	5.08	10.16	2x14	33.02	38.10	2x25	60.96	66.04
2x04	7.62	12.70	2x15	35.56	40.64	2x26	63.50	68.58
2x05	10.16	15.24	2x16	38.10	43.18	2x27	66.04	71.12
2x06	12.70	17.78	2x17	40.64	45.72	2x28	68.58	73.66
2x07	15.24	20.32	2x18	43.18	48.26	2x29	71.12	76.20
2x08	17.78	22.86	2x19	45.72	50.80	2x30	73.66	78.74
2x09	20.32	25.40	2x20	48.26	53.34	2x31	76.20	81.28
2x10	22.86	27.94	2x21	50.80	55.88	2x32	78.74	83.82
2x11	25.40	30.48	2x22	53.34	58.42			
2x12	27.94	33.02	2x23	55.88	60.96			

X2530WR-2xXX-PTSN	PBT UL 94V-0	Brass	Tin-Plated	X2530H
PART NO	Material	Material(Pin)	Finish(Pin)	Suitable XKB Terminal

DSND		DATE		SCALE: N/A	MODEL TYPE: Wire to board connector
DWN		DATE		VIEW:	PART NO.: 2.54mm Crimp Style Connectors
CHKD		DATE		UNIT: mm/in	DWG NO.: X2530WR-2xXX-PTSN
APPD		DATE		SIZE: A4	
KKB INDUSTRIAL PRECISION CO., LIMITED					WEIGHT 1.0g
					SHEET 1/1
					REVISION A0

广东星坤科技股份有限公司  
 Recommended PCB Layout  
 General Tolerance±0.05

生	日期					units: mm
ΔX						tolerance: X.X ±0.2mm
ΔX						X.XX ±0.1mm
ΔX						X.XXX ±0.05mm
MARK	DESCRIPTION	DATE	REVISED	APPROVED		UNSPECIFIED TOLERANCES
www.xk-dg.cn www.hellokxb.com www.hellokxb.cn						

文件工程章

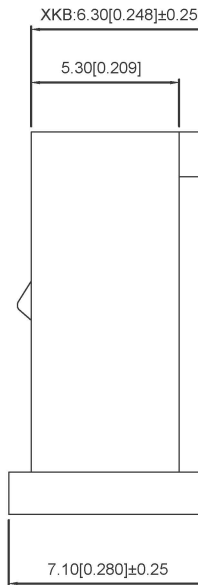
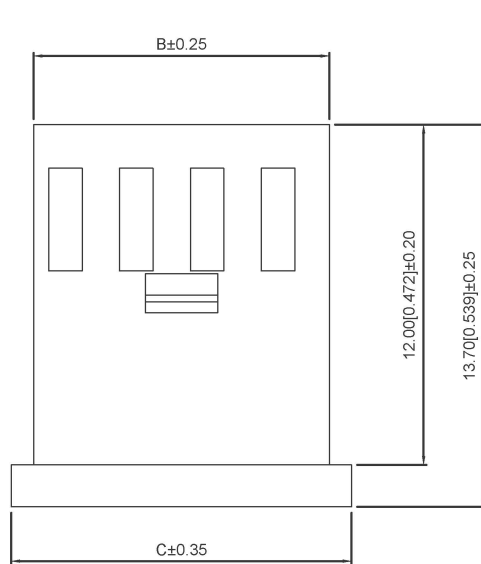
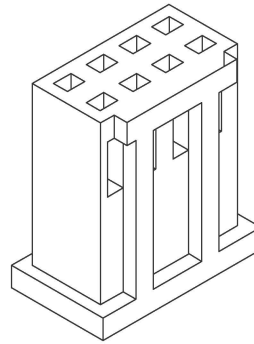
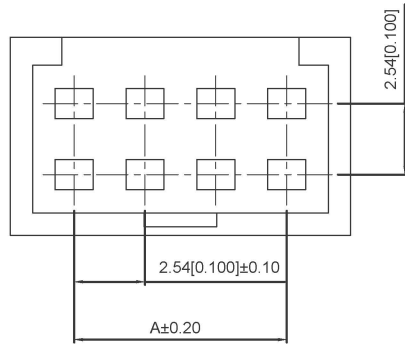

**Specifications:**

规格:  
**Voltage rating:**250V AC/DC  
 额定电压: 250V AC/DC  
**Current rating:**3A AC/DC  
 额定电流: 3A AC/DC  
**Withstanding voltage:**800V AC/minute  
 耐受电压:800V AC/分钟  
**Temperature range:**-25°C~+85°C  
 温度范围: -25°C~+85°C  
**Insulation resistance:**≥1000MΩ  
 绝缘电阻: ≥1000MΩ  
**Contact resistance:**≤10mΩ  
 接触电阻: ≤10mΩ  
**After environmental testing:**≤20mΩ  
 环境测试后: ≤20兆欧

**X2530 H X-2xXX X-PT XX**

① ②③ ④ ⑤⑥ ⑦

1. Series No
2. Category:H-HSG
3. Welding Board Angle:Blank-ordinary
4. Row No-Pin No:2xXX-2x02P~2x32P
5. Plug the Pin&Special No:
6. Materail:PT-PBT 94V-0
7. Color:Blank-natural color black

poles	Dimensions(mm)			poles	Dimensions(mm)			poles	Dimensions(mm)		
	A	B	C		A	B	C		A	B	C
2x02	2.54	5.52	7.12	2x13	30.48	33.46	35.06	2x24	58.42	61.40	63.00
2x03	5.08	8.06	9.66	2x14	33.02	36.00	37.60	2x25	60.96	63.94	65.54
2x04	7.62	10.60	12.20	2x15	35.56	38.54	40.14	2x26	63.50	66.48	68.08
2x05	10.16	13.14	14.74	2x16	38.10	41.08	42.68	2x27	66.04	69.02	70.62
2x06	12.70	15.68	17.28	2x17	40.64	43.62	45.22	2x28	68.58	71.56	73.16
2x07	15.24	18.22	19.82	2x18	43.18	46.16	47.76	2x29	71.12	74.10	75.70
2x08	17.78	20.76	22.36	2x19	45.72	48.70	50.30	2x30	73.66	76.64	78.24
2x09	20.32	23.30	24.90	2x20	48.26	51.24	52.84	2x31	76.20	79.18	80.78
2x10	22.86	25.84	27.44	2x21	50.80	53.78	55.38	2x32	78.74	81.72	83.32
2x11	25.40	28.38	29.98	2x22	53.34	56.32	57.92				
2x12	27.94	30.92	32.52	2x23	55.88	58.86	60.46				

X2530H-2xXX-PT	PBT UL 94V-0	X2530T	X2530W
PART NO	Material	Suitable XKB Terminal	Suitable XKB Terminal

广东星坤科技股份有限公司

生效	日期
ΔX	ΔX
ΔX	ΔX
MARK	文件工程章

DATE	REVISED	APPROVED	UNSPECIFIED TOLERANCES

DSND	DATE	SCALE: N/A
DWN	DATE	VIEW:
CHKD	DATE	UNIT: mm/in
APPD	DATE	SIZE: A4
KKB INDUSTRIAL PRECISION CO., LIMITED		

MODEL TYPE: Wire to board connector		
PART NO.: 2.54mm Crimp Style Connectors		
DWG NO.: X2530H-2xXX-PT		
WEIGHT 1.0g	SHEET 1/1	REVISION A0

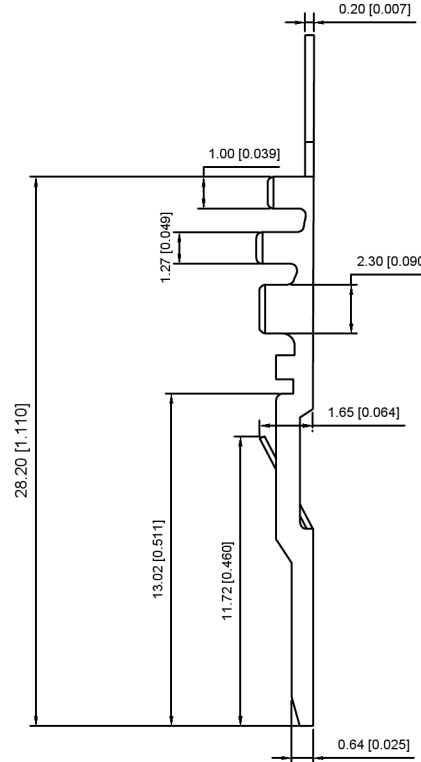
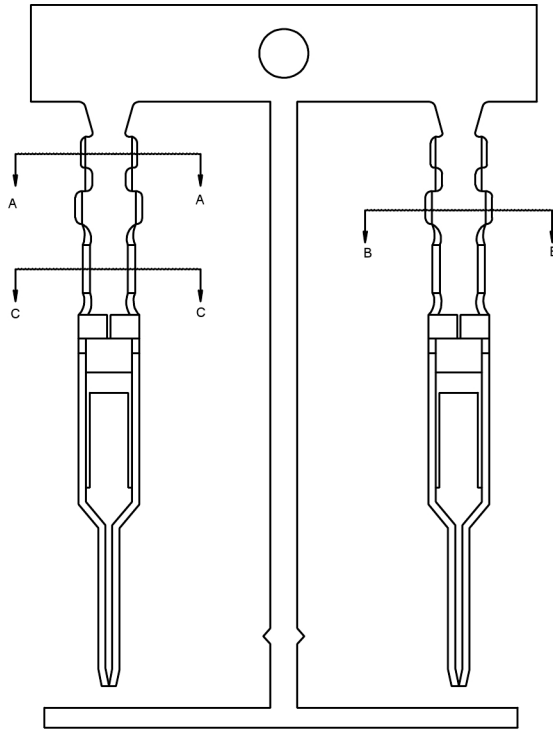

■ Specifications :

- Voltage rating: 250V AC / DC
- Current rating: 3A AC / DC
- Withstanding voltage: 800V AC/minute
- Temperature range: -25°C~+85°C
- Insulation resistance:  $\geq 1000M \Omega$
- Contact resistance:  $\leq 20m\Omega$
- After environmental testing :  $\leq 30m\Omega$

X2530 T M - P SN  
① ② ③ ④ ⑤

- ① Series No.
- ② Category : T-Terminal
- ③ Shape:M-male
- ④ Material: P-Phosphor bronze ;
- ⑤ Plating Style: SN-Bright Tin Plating (70u")

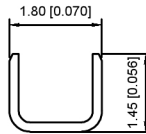

SECTION A-A  
SCALE 1:1

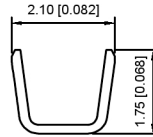

SECTION B-B  
SCALE 1:1

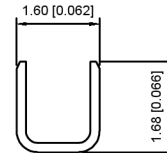

SECTION C-C  
SCALE 1:1

X2530TM-PSN	Phosphor Bronze	AWG#22-26 O.D1.55mm	X2530H
PART NO	Material	Wire Range	Suitable XKB Housing

DSND		SCALE: N/A	MODEL TYPE: 2.54mm Crimp Style Connector
DWN		VIEW:	PART NO.: X2530TM-PSN
CHKD		UNIT: mm/in	DWG NO.: X-X2530TM-PSN
APPD		SIZE: A4	

广东星坤科技股份有限公司

设计	日期
审核	
XX	

文件工程草

REVISIONS	UNSPECIFIED TOLERANCES
ANGLAR	±5°
L ≤ 4	±0.2
4 < L ≤ 16	±0.3
16 < L ≤ 63	±0.4
L > 63	±0.5
MARK	DESCRIPTION
DATE	REVISED
APPROVED	



XKB INDUSTRIAL PRECISION CO., LIMITED

WEIGHT	SHEET	REVISION
	1/1	A0

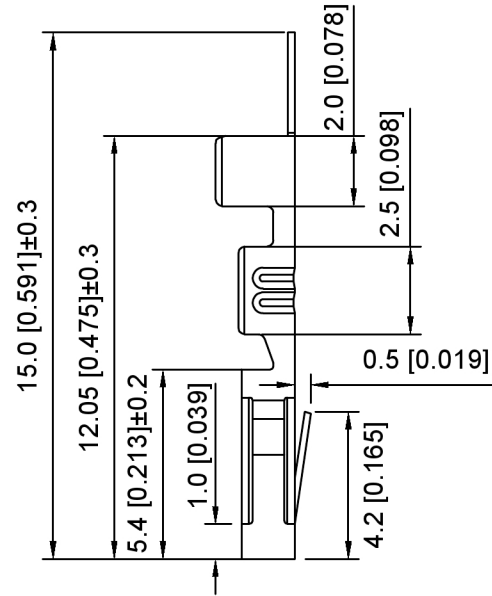
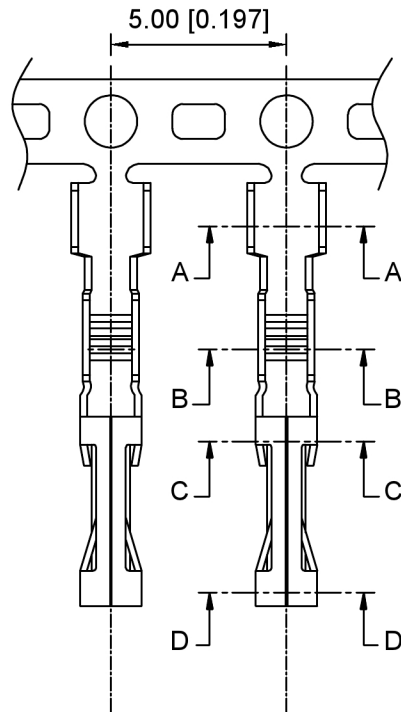

Specifications:

规格:  
 Voltage rating:250V AC/DC  
 额定电压: 250V AC/DC  
 Current rating:4A AC/DC  
 额定电流: 4A AC/DC  
 Withstanding voltage:1000V AC/minute  
 耐受电压: 1000V AC/分钟  
 Temperature range:-40°C-+85°C  
 温度范围: -40°C-+85°C  
 Insulation resistance:1000MΩ min  
 绝缘电阻: 1000MΩ Min  
 Contact resistance:20mΩ Max  
 接触电阻: 20mΩ Max

X2530 T F - P SN  
 ① ② ③ ④ ⑤

1. Series No
2. Category:T-Terminal
3. Category:F-Female Terminal
4. Material:P-Phosphor Bronze
5. Plating:SN-Tin Plated

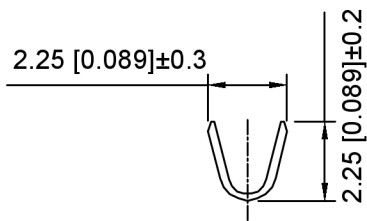

SEC:A-A

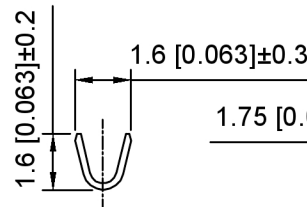

SEC:A-A

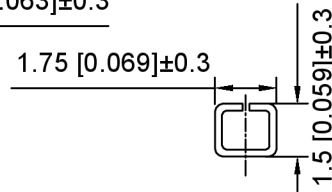

SEC:A-A

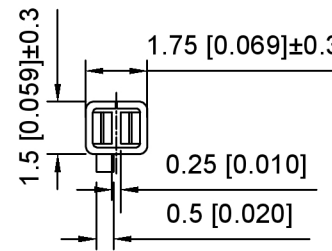

SEC:A-A

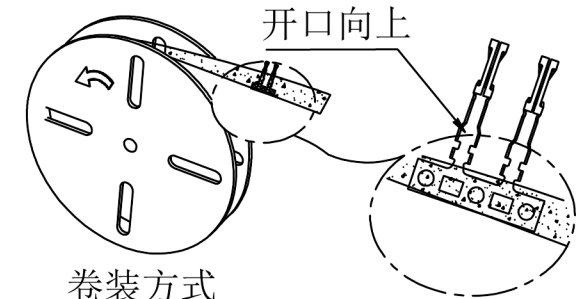

X2530TF-PSN	Phosphor Bronze	AWG#22~26 O.D1.55mm	X2530H
PART NO	Material	Wire Range	Suitable XKB Housing

DSND		SCALE: N/A	MODEL TYPE: 2.54mm Crimp Style Connector
DWN		VIEW:	PART NO.: X2530TF-PSN
CHKD		UNIT: mm/in	DWG NO.: X-X2530TF-PSN
APPD		SIZE: A4	WEIGHT SHEET REVISION



XKB INDUSTRIAL PRECISION CO., LIMITED

WEIGHT	SHEET	REVISION
	1/1	A0

广东星坤科技股份有限公司

姓名 日期  
 数量 日期

MARK DESCRIPTION DATE REVISED APPROVED

REVISIONS

UNSPECIFIED TOLERANCES