

0.64 [0.025]

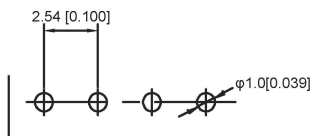

Recommended P.C.B Layout  
General Tolerance±0.05

■ Specifications :

- Voltage rating: 250V AC / DC
- Current rating: 3A AC / DC
- Withstanding voltage: 800V AC/minute
- Temperature range: -25°C~+85°C
- Insulation resistance: ≥1000M Ω
- Contact resistance: ≤10mΩ
- After environmental testing : ≤20mΩ

X2530 W V-XX - PT SN

- ① Series No.
- ② Category : W-WAFER
- ③ Wedding Board Angle : V-Stright 180°
- ④ Row No.-Pin No.: XX-02P~22P
- ⑤ Material : PT-PBT 94V-0
- ⑥ Plating Category: Sn-Bright Tin Plating

Poles	Dimensions(mm)		Poles	Dimensions(mm)	
	A	B		A	B
02	2.54	7.70	12	27.94	33.10
03	5.08	10.20	13	30.48	35.60
04	7.62	12.70	14	33.02	38.10
05	10.16	15.20	15	35.56	40.70
06	12.70	17.80	16	38.10	43.20
07	15.24	20.30	17	40.64	45.70
08	17.78	22.90	18	43.18	48.20
09	20.32	25.40	19	45.72	50.70
10	22.86	28.00	20	48.26	53.20
11	25.40	30.50	22	53.34	58.50

X2530WV-XX-PTS	PBT UL 94V-0	Brass	Tin-Plated	X2530WV-XX-PTS
PART NO	Material	Material(Pin)	Finish(Pin)	Suitable XKB Terminal

广东星坤科技股份有限公司

生效

ΔX	日期
ΔX	日期
ΔX	日期
MARK	DESCRIPTION

REVISIONS

ANGLAR	±5°
L ≤ 4	±0.2
4 < L ≤ 16	±0.3
16 < L ≤ 63	±0.4
L > 63	±0.5

UNSPECIFIED TOLERANCES

DSND	DATE	SCALE: N/A	MODEL TYPE: X2530WV-XX-PTS
DWN	DATE	VIEW:	PART NO.: 2.54mm Crimp Style Connectors
CHKD	DATE	UNIT: mm/in	DWG NO.:
APPD	DATE	SIZE: A4	
XKB INDUSTRIAL PRECISION CO., LIMITED			WEIGHT 1.0g
			SHEET 1/1
			REVISION A0

文件工程章

www.xk-dg.cn www.helloxkb.com www.helloxkb.cn

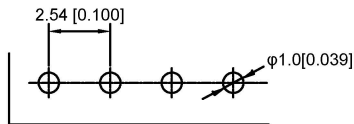
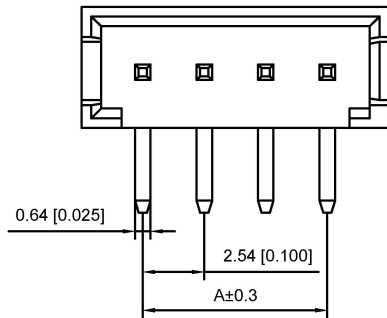
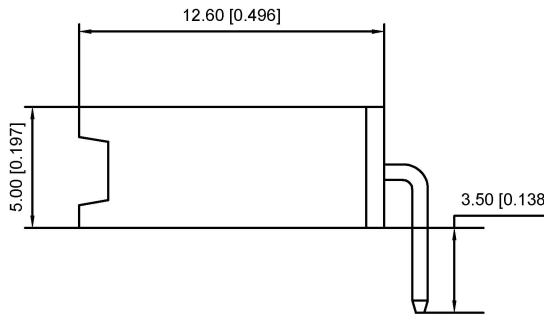
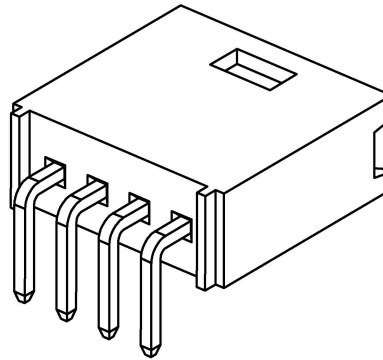
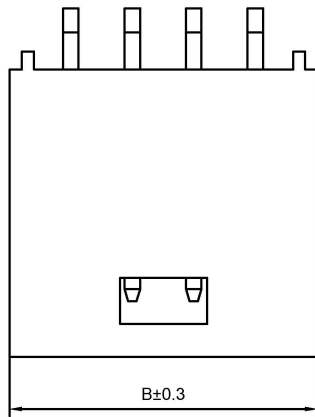

Recommended D.C.P Layout  
General Tolerance ±0.05

■ Specifications :

- Voltage rating: 250V AC / DC
- Current rating: 3A AC / DC
- Withstanding voltage: 800V AC/minute
- Temperature range: -25°C~+85°C
- Insulation resistance: ≥1000M Ω
- Contact resistance: ≤10mΩ
- After environmental testing : ≤20mΩ

X2530 W R-XX - PT SN  
① ② ③ ④ ⑤ ⑥

- ① Series No.
- ② Category : W-WAFER
- ③ Wedding Board Angle : R-S tright 90°
- ④ Row No.-Pin No.: XX-02P~22P
- ⑤ Material : PT-PBT 94V-0
- ⑥ Plating Category: Sn-Bright Tin Plating

Poles	Dimensions(mm)		Poles	Dimensions(mm)	
	A	B		A	B
02	2.54	7.70	12	27.94	33.10
03	5.08	10.20	13	30.48	35.60
04	7.62	12.70	14	33.02	38.10
05	10.16	15.20	15	35.56	40.70
06	12.70	17.80	16	38.10	43.20
07	15.24	20.30	17	40.64	45.70
08	17.78	22.90	18	43.18	48.20
09	20.32	25.40	19	45.72	50.70
10	22.86	28.00	20	48.26	53.20
11	25.40	30.50	22	53.34	58.50

X2530WR-XX-PTSN	PBT UL 94V-0	Brass	Tin-Plated	X2530WR-XX-PTSN
PART NO	Material	Material(Pin)	Finish(Pin)	Suitable XKB Terminal

广东星坤科技股份有限公司

生效

日期

文件工程章

REVISIONS	DATE	REVISED	APPROVED	UNSPECIFIED TOLERANCES
ANGLAR	±5°			
L ≤ 4	±0.2			
4 < L ≤ 16	±0.3			
16 < L ≤ 63	±0.4			
L > 63	±0.5			

DSND	DATE	SCALE: N/A	MODEL TYPE: X2530WR-XX-PTSN
DWN	DATE	VIEW:	PART NO.: 2.54mm Crimp Style Connectors
CHKD	DATE	UNIT: mm/in	DWG NO.:
APPD	DATE	SIZE: A4	
XKB INDUSTRIAL PRECISION CO., LIMITED			WEIGHT 1.0g
			SHEET 1/1
			REVISION A0

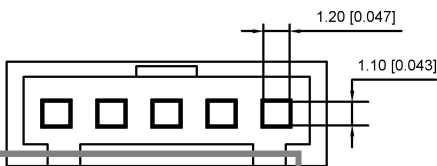
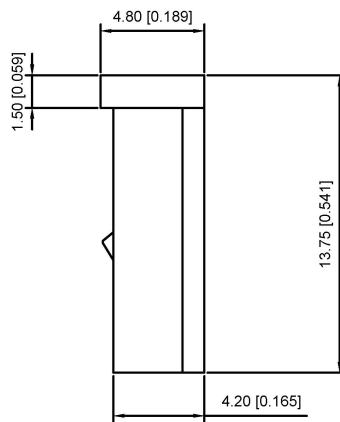
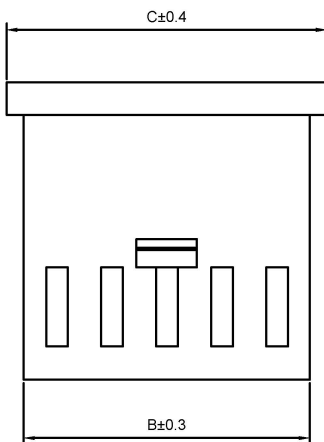
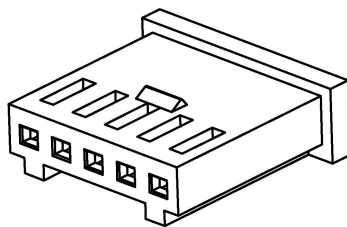
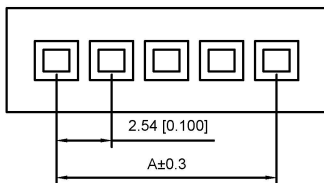

■ Specifications :

- Voltage rating: 250V AC / DC
- Current rating: 3A AC / DC
- Withstanding voltage: 1000V AC/minute
- Temperature range: -25°C~+85°C
- Insulation resistance: ≥1000M Ω
- Contact resistance: ≤10mΩ
- After environmental testing : ≤20mΩ

X2530 H XX- PT  
① ② ③ ④ ⑤

- ① Series No.
- ② Category : H-HSG
- ③ Appearance type:Blank-Ordinary
- ④ Row No.-Pin No.: XX-02P~22P
- ⑤ Material : PT-PBT 94V-0

Poles	Dimensions(mm)			Poles	Dimensions(mm)		
	A	B	C		A	B	C
02	2.54	5.60	7.10	12	27.94	31.00	32.50
03	5.08	8.14	9.64	13	30.48	33.54	35.04
04	7.62	10.68	12.18	14	33.02	36.08	37.58
05	10.16	13.22	14.72	15	35.56	38.62	40.12
06	12.70	15.76	17.26	16	38.10	41.16	42.66
07	15.24	18.30	19.80	17	40.64	43.70	45.20
08	17.78	20.84	22.34	18	43.18	46.24	47.74
09	20.32	23.38	24.88	19	45.72	48.78	50.28
10	22.86	25.92	27.42	20	48.26	51.32	52.82
11	25.40	28.46	29.96	22	53.34	56.40	57.90

X2530H-XX-PT	PBT UL 94V-0	X2530T	X2530W
PART NO	Material	Suitable XKB Terminal	Suitable XKB Terminal

广东星坤科技股份有限公司

生效

ΔX	日期
ΔX	
ΔX	
MARK	DESCRIPTION

文件工程章

REVISIONS

www.xk-dg.cn www.helloxkb.com www.helloxkb.cn

ANGLAR	±5°
L ≤ 4	±0.2
4 < L ≤ 16	±0.3
16 < L ≤ 63	±0.4
L > 63	±0.5

UNSPECIFIED TOLERANCES

DSND	DATE	SCALE: N/A	MODEL TYPE: X2530H-XX-N0
DWN	DATE	VIEW:	PART NO.: 2.5mm Crimp Style Connectors
CHKD	DATE	UNIT: mm/in	DWG NO.:
APPD	DATE	SIZE: A4	
XKB INDUSTRIAL PRECISION CO., LIMITED			WEIGHT 1.0g
			SHEET 1/1
			REVISION A0

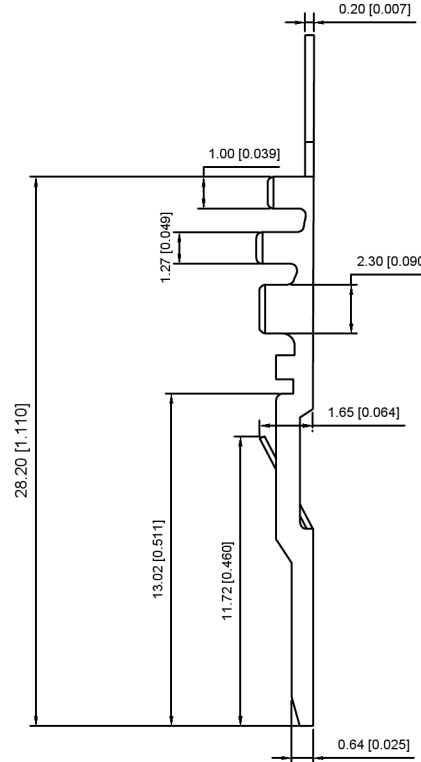
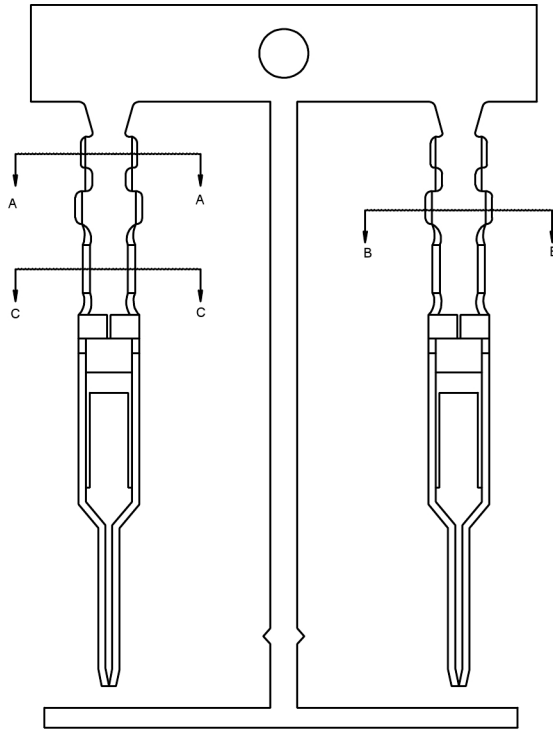

■ Specifications :

- Voltage rating: 250V AC / DC
- Current rating: 3A AC / DC
- Withstanding voltage: 800V AC/minute
- Temperature range: -25°C~+85°C
- Insulation resistance:  $\geq 1000M \Omega$
- Contact resistance:  $\leq 20m\Omega$
- After environmental testing :  $\leq 30m\Omega$

X2530 T M - P SN  
① ② ③ ④ ⑤

- ① Series No.
- ② Category : T-Terminal
- ③ Shape:M-male
- ④ Material: P-Phosphor bronze ;
- ⑤ Plating Style: SN-Bright Tin Plating (70u")

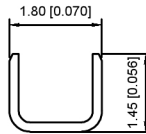

SECTION A-A  
SCALE 1:1

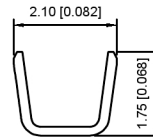

SECTION B-B  
SCALE 1:1

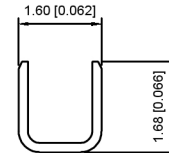

SECTION C-C  
SCALE 1:1

X2530TM-PSN	Phosphor Bronze	AWG#22-26 O.D1.55mm	X2530H
PART NO	Material	Wire Range	Suitable XKB Housing

DSND		SCALE: N/A	MODEL TYPE: 2.54mm Crimp Style Connector
DWN		VIEW:	PART NO.: X2530TM-PSN
CHKD		UNIT: mm/in	DWG NO.: X-X2530TM-PSN
APPD		SIZE: A4	

广东星坤科技股份有限公司

设计	日期
审核	
XX	

文件工程草

MARK	DESCRIPTION	DATE	REVISED	APPROVED	ANGLAR	±5°
					L ≤ 4	±0.2
					4 < L ≤ 16	±0.3
					16 < L ≤ 63	±0.4
					L > 63	±0.5
REVISIONS					UNSPECIFIED TOLERANCES	



XKB INDUSTRIAL PRECISION CO., LIMITED

WEIGHT	SHEET	REVISION
	1/1	A0

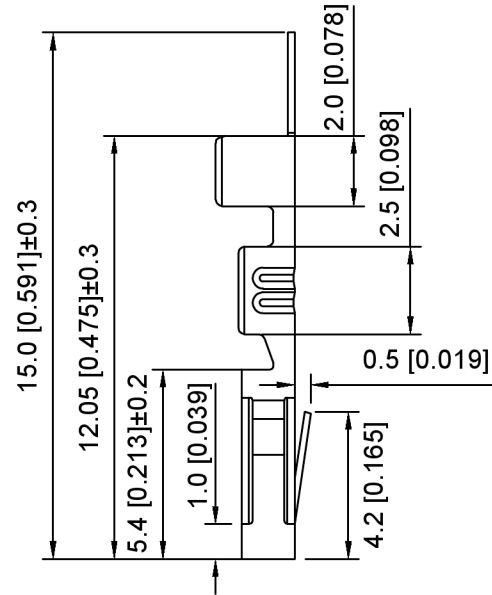
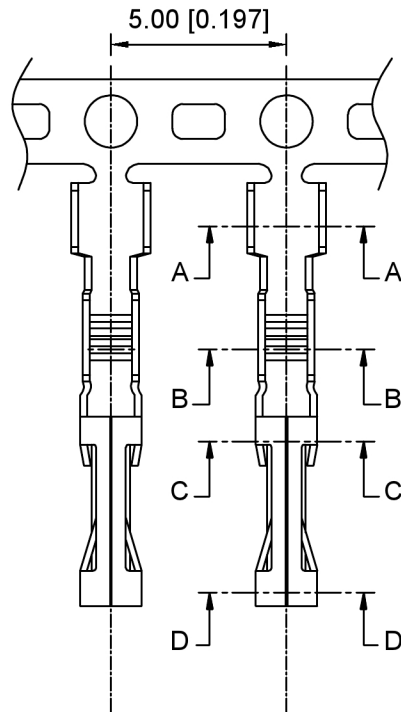

Specifications:

规格:

Voltage rating: 250V AC/DC

额定电压: 250V AC/DC

Current rating: 4A AC/DC

额定电流: 4A AC/DC

Withstanding voltage: 1000V AC/minute

耐受电压: 1000V AC/分钟

Temperature range: -40°C~+85°C

温度范围: -40°C~+85°C

Insulation resistance: 1000MΩ min

绝缘电阻: 1000MΩ Min

Contact resistance: 20mΩ Max

接触电阻: 20mΩ Max

X2530 T F - P SN  
① ② ③ ④ ⑤

1. Series No

2. Category: T-Terminal

3. Category: F-Female Terminal

4. Material: P-Phosphor Bronze

5. Plating: SN-Tin Plated

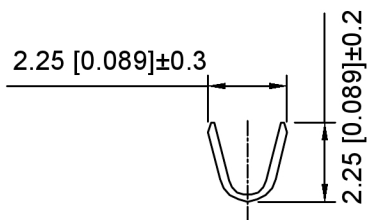

SEC:A-A

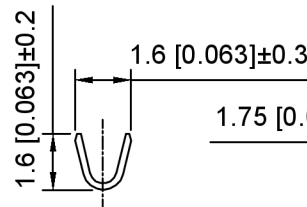

SEC:A-A

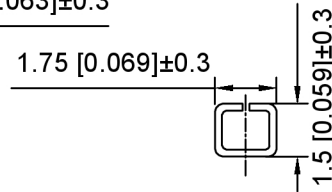

SEC:A-A

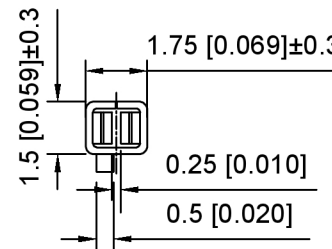

SEC:A-A

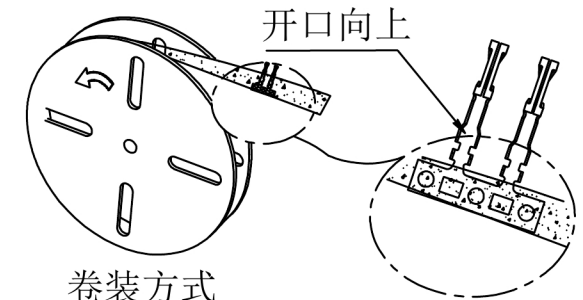

X2530TF-PSN	Phosphor Bronze	AWG#22~26 O.D1.55mm	X2530H
PART NO	Material	Wire Range	Suitable XKB Housing

DSND	SCALE: N/A	MODEL TYPE: 2.54mm Crimp Style Connector
DWN	VIEW:	PART NO.: X2530TF-PSN
CHKD	UNIT: mm/in	DWG NO.: X-X2530TF-PSN
APPD	SIZE: A4	WEIGHT

XKLB

XKB INDUSTRIAL PRECISION CO., LIMITED

SHEET	REVISION
1/1	A0

广东星坤科技股份有限公司

姓名	日期
数量	
文件工程章	

MARK	DESCRIPTION	DATE	REVISED	APPROVED	UNSPECIFIED TOLERANCES