

**Specifications:**

规格:

Voltage rating:250V AC/DC  
 额定电压: 250V AC/DC  
 Current rating:3A AC/DC  
 额定电流: 3A AC/DC  
 Withstanding voltage:1000V AC/minute  
 耐受电压: 1000V AC/分钟  
 Temperature range:-25°C~+85°C  
 温度范围: -25°C~+85°C  
 Insulation resistance:≥1000MΩ  
 绝缘电阻: ≥1000MΩ  
 Contact resistance:≤30mΩ  
 接触电阻: ≤30mΩ  
 After environmental testing:≤50mΩ  
 环境测试后: ≤50兆欧

X2026 W V X-2xXXD-XX XX XX

① ② ③ ④ ⑤ ⑥ ⑦ ⑧ ⑨

- 1.Series No
- 2.Category:W-WAFER
- 3.Welding Board Angle:V-Straight 180°
- 4.Welding Way:Blank-DIP
- 5.Row No-Pin No:2xXX-2x02P~2x22P
- 6.Plug the Pin&Special NO:  
D-With Lock in the middle
- 7.Material:46-PA46 94V-0.9T-PA9T 94V-0  
4T-PA4T 94V-0
- 8.Plating Category:SN-Bright Tin Plating  
V03-All Gold-Plated 3u"
- 9.Color:Blank-Natural Color

poles	Dimensions(mm)			poles	Dimensions(mm)			Poles	Dimensions(mm)		
	A	B	C		A	B	C		A	B	C
2x02	2.00	6.00	4.90	2x10	18.00	22.00	20.90	2x18	34.00	38.00	36.90
2x03	4.00	8.00	6.90	2x11	20.00	24.00	22.90	2x19	36.00	40.00	38.90
2x04	6.00	10.00	8.90	2x12	22.00	26.00	24.90	2x20	38.00	42.00	40.90
2x05	8.00	12.00	10.90	2x13	24.00	28.00	26.90	2x30	58.00	62.00	60.90
2x06	10.00	14.00	12.90	2x14	26.00	30.00	28.90				
2x07	12.00	16.00	14.90	2x15	28.00	32.00	30.90				
2x08	14.00	18.00	16.90	2x16	30.00	34.00	32.90				
2x09	16.00	20.00	18.90	2x17	32.00	36.00	34.90				

X2026WV-2xXXD-4T SN	PA4T 94V-0	Brass	Tin-Plated	X2026H-D
X2026WV-2xXXD-9T V03	PA9T 94V-0		Gold-Plated 3u"	
X2026WV-2xXXD-46 SN	PA46 94V-0		Tin-Plated	
PART NO	Material	Material(pin)	Finish(Pin)	Suitable XKB Terminal

广东星坤科技股份有限公司  
 星坤科技  
 星坤科技

生 日期  
 ΔX 日期  
 ΔX 日期  
 MARK 文件工程章

DATE	REVISED	APPROVED	units:	mm
			tolerance:	
			X.X	±0.2mm
			X.XX	±0.1mm
			X.XXX	±0.05mm
UNSPECIFIED TOLERANCES				

DSND		DATE		SCALE: N/A	MODEL TYPE: Wire to board connector
DWN		DATE		VIEW:	PART NO.: 2.00mm Crimp Style Connectors
CHKD		DATE		UNIT: mm/in	DWG NO.: X2026WV-2xXXD-XXXXX
APPD		DATE		SIZE: A4	
KKB INDUSTRIAL PRECISION CO., LIMITED					WEIGHT 1.0g
					SHEET 1/1
					REVISION A0

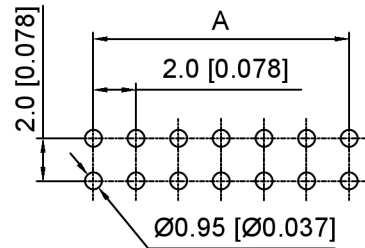
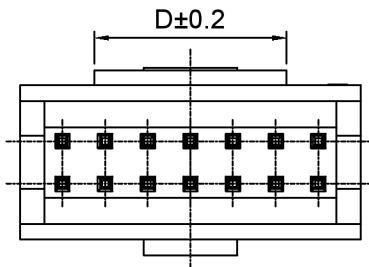
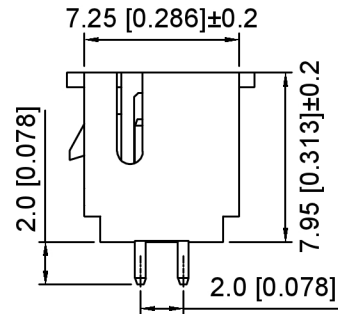
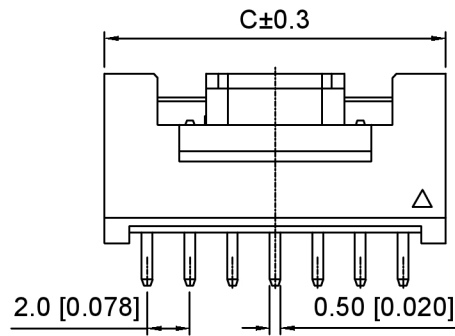
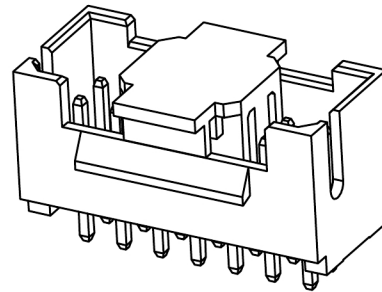
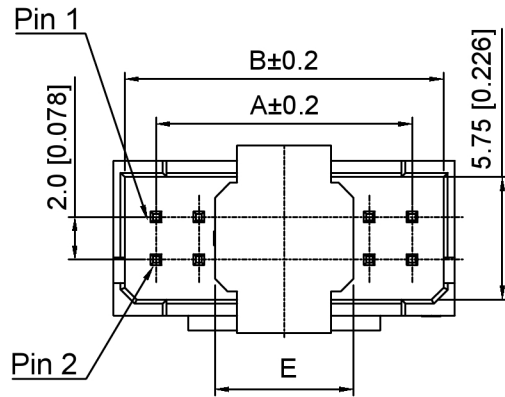

Recommended PCB Layout(Top view)  
Tolerance:±0.05mm

Specifications:

规格:

Voltage rating:250V AC/DC

额定电压: 250V AC/DC

Current rating:3A AC/DC

额定电流: 3A AC/DC

Withstanding voltage:1000V AC/minute

耐受电压: 1000V AC/分钟

Temperature range:-25°C-+85°C

温度范围: -25°C-+85°C

Insulation resistance:≥1000MΩ

绝缘电阻: ≥1000MΩ

Contact resistance:≤30mΩ

接触电阻: ≤30mΩ

X2026 W V - 2xXX D R - LP SN  
① ② ③ ④ ⑤ ⑥ ⑦ ⑧

1. Series No
2. Category:W-Wafer
3. Welding Board Angle:V-Stright 180°
4. Row No. Pin No:2xXX-2x02~2x16Pin
5. Special No:D-With Lock
6. Special No:R-DIP 2.0mm
7. Material:LP-LCP UL94V-0 ,Natural  
CAP:LCP UL94V-0 ,Natural
8. Plating:SN- Tin Plated

Poles	Dimensions (mm)					Poles	Dimensions (mm)				
	A	B	C	D	E		A	B	C	D	E
2x02	2.00	4.95	6.60	3.00	4.50	2x10	18.00	20.95	22.60	15.00	6.50
2x03	4.00	6.95	8.60			2x11	20.00	22.95	24.60	17.00	
2x04	6.00	8.95	10.60			2x12	22.00	24.95	26.60	19.00	
2x05	8.00	10.95	12.60	5.00	6.50	2x13	24.00	26.95	28.60	21.00	
2x06	10.00	12.95	14.60			2x14	26.00	28.95	30.60	23.00	
2x07	12.00	14.95	16.60	9.00	6.50	2x15	28.00	30.95	32.60	25.00	
2x08	14.00	16.95	18.60			2x16	30.00	32.95	34.60	27.00	
2x09	16.00	18.95	20.60	13.00		/					

X2026WV-2xXXDR-LPSN	LCP	Brass	X2026H
PART NO	Material	Material(Pin)	Suitable XKB Housing

DSND	SCALE: N/A	MODEL TYPE: 2.0mm Crimp Style Connector
DWN	VIEW:	PART NO.: X2026WV-2xXXDR-LPSN
CHKD	UNIT: mm/in	DWG NO.: X-X2026WV-2xXXDR-LPSN
APPD	SIZE: A4	



XKB INDUSTRIAL PRECISION CO., LIMITED

WEIGHT	SHEET	REVISION
	1/1	A0

广东星坤科技股份有限公司

Δ定	日期
Δ改	日期
ΔX	

MARK	DESCRIPTION	DATE	REVISED	APPROVED
------	-------------	------	---------	----------

文件工程章

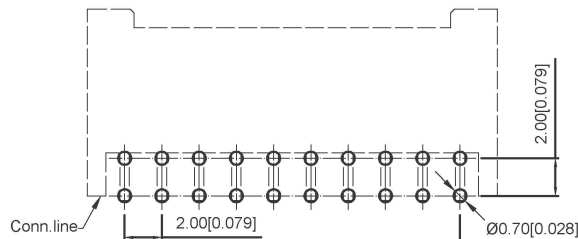
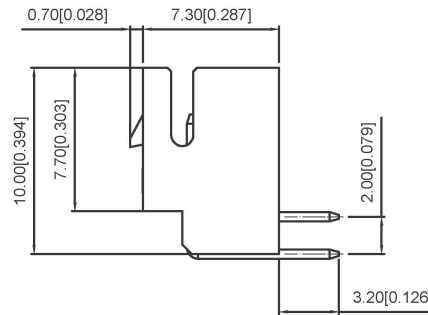
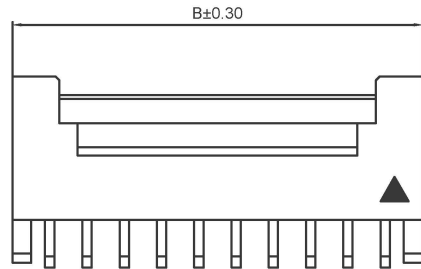
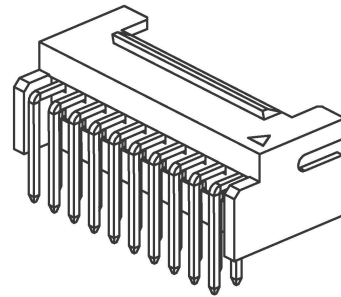
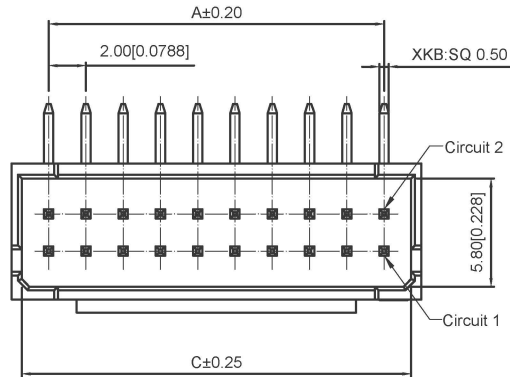

**Specifications:**

规格:  
 Voltage rating:250V AC/DC  
 额定电压: 250V AC/DC  
 Current rating:3A AC/DC  
 额定电流: 3A AC/DC  
 Withstanding voltage:1000V AC/minute  
 耐受电压: 1000V AC/分钟  
 Temperature range:-25℃~+85℃  
 温度范围: -25℃~+85℃  
 Insulation resistance:≥1000MΩ  
 绝缘电阻: ≥1000MΩ  
 Contact resistance:≤30mΩ  
 接触电阻: ≤30mΩ  
 After environmental testing:≤50mΩ  
 环境测试后: ≤50兆欧

**X2026 W V X-2xXXD- 46 SN XX**

① ② ③ ④ ⑤ ⑥ ⑦ ⑧ ⑨

- 1.Series No
- 2.Category:W-WAFER
- 3.Welding Board Angle:R-Right Angle 90°
- 4.Welding Way:Blank-DIP
- 5.Row No-Pin No:2xXX-2x04P~2x30P
- 6.Plug the Pin&Special NO:  
D-With Lock in the middle
- 7.Material:46-PA46 94V-0,4T-PA4T 94V-0
- 8.Plating Category:SN-Bright Tin Plating
- 9.Color: Blank-Natural Color

poles	Dimensions(mm)			poles	Dimensions(mm)			poles	Dimensions(mm)		
	A	B	C		A	B	C		A	B	C
2x02	2.00	6.00	4.90	2x10	18.00	22.00	20.90	2x18	34.00	38.00	36.90
2x03	4.00	8.00	6.90	2x11	20.00	24.00	22.90	2x19	36.00	40.00	38.90
2x04	6.00	10.00	8.90	2x12	22.00	26.00	24.90	2x20	38.00	42.00	40.90
2x05	8.00	12.00	10.90	2x13	24.00	28.00	26.90	2x30	58.00	62.00	60.90
2x06	10.00	14.00	12.90	2x14	26.00	30.00	28.90				
2x07	12.00	16.00	14.90	2x15	28.00	32.00	30.90				
2x08	14.00	18.00	16.90	2x16	30.00	34.00	32.90				
2x09	16.00	20.00	18.90	2x17	32.00	36.00	34.90				

X2026WR-2xXXD-4T SN	PA4T 94V-0	Brass	Tin-Plated	X2026H-D
X2026WR-2xXXD-46 SN	PA46 94V-0	Brass	Tin-Plated	X2026H-D
PART NO	Material	Material(pin)	Finish(Pin)	Suitable XKB Terminal

广东星坤科技股份有限公司  
 Recommended Pin Layout  
 General Tolerances±0.05

生	日期	DESCRIPTION	DATE	REVISED	APPROVED	units:	mm
Δ×效						tolerance:	
Δ×						X.X	±0.2mm
Δ×						X.XX	±0.1mm
MARK						X.XXX	±0.05mm
文件工程章						UNSPECIFIED TOLERANCES	
REVISIONS						www.xk-dg.cn www.helloxkb.com www.helloxkb.cn	

DSND		DATE		SCALE: N/A	MODEL TYPE: Wire to board connector	
DWN		DATE		VIEW:	PART NO.: 2.00mm Crimp Style Connectors	
CHKD		DATE		UNIT: mm/in	DWG NO.: X2026WR-2xXXD-XXSN	
APPD		DATE		SIZE: A4		
KKB INDUSTRIAL PRECISION CO.,LIMITED				WEIGHT	SHEET	REVISION
				1.0g	1/1	A0

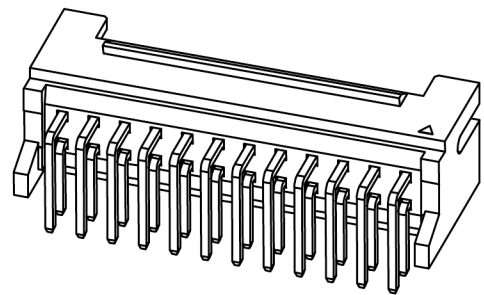
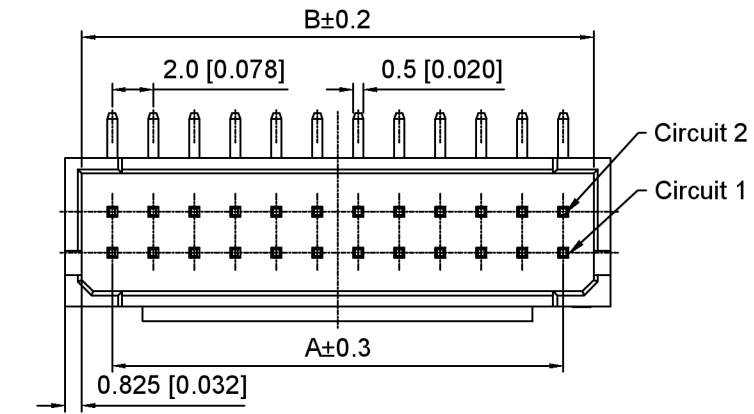

Specifications:  
 规格:  
 Voltage rating:250V AC/DC  
 额定电压: 250V AC/DC  
 Current rating:3A AC/DC  
 额定电流: 3A AC/DC  
 Withstanding voltage:1000V AC/minute  
 耐受电压: 1000V AC/分钟  
 Temperature range:-25℃~+85℃  
 温度范围: -25℃~+85℃  
 Insulation resistance:≥1000MΩ  
 绝缘电阻: ≥1000MΩ  
 Contact resistance:≤30mΩ  
 接触电阻: ≤30mΩ

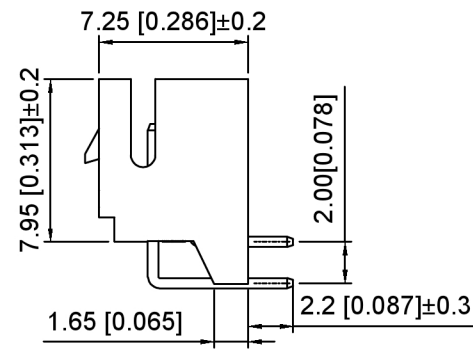
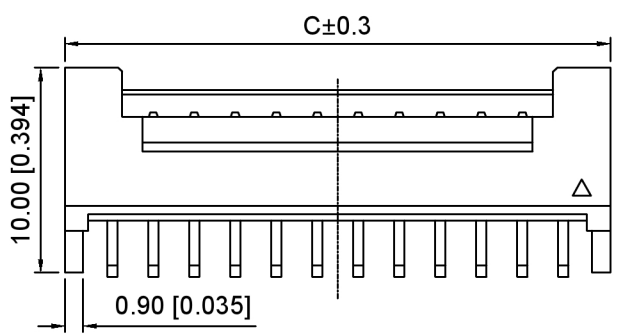

X2026 W R - 2xXX D R - LP SN  
 ① ② ③ ④ ⑤ ⑥ ⑦ ⑧

1. Series No
2. Category:W-Wafer
3. Welding Board Angle:R-Stright 90°
4. Row No.Pin No:2xXX-2x02~2x16Pin
5. Special No:D-With Lock
6. Special No:R-DIP 2.2mm
7. Material:LP-LCP UL94V-0 ,Natural  
CAP:LCP UL94V-0 ,Natural
8. Plating:SN- Tin Plated

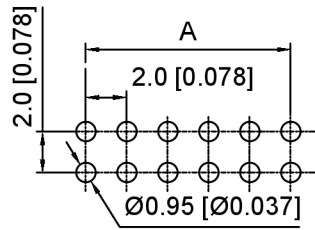
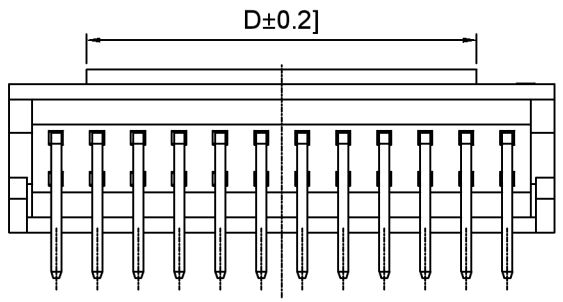

Recommended PCB Layout(Top view)  
 Tolerance:±0.05mm

Poles	Dimensions (mm)				Poles	Dimensions (mm)			
	A	B	C	D		A	B	C	D
2x02	2.00	4.95	6.60	3.00	2x10	18.00	20.95	22.60	15.00
2x03	4.00	6.95	8.60		2x11	20.00	22.95	24.60	17.00
2x04	6.00	8.95	10.60	5.00	2x12	22.00	24.95	26.60	19.00
2x05	8.00	10.95	12.60		2x13	24.00	26.95	28.60	21.00
2x06	10.00	12.95	14.60	7.00	2x14	26.00	28.95	30.60	23.00
2x07	12.00	14.95	16.60	9.00	2x15	28.00	30.95	32.60	25.00
2x08	14.00	16.95	18.60	11.00	2x16	30.00	32.95	34.60	27.00
2x09	16.00	18.95	20.60	13.00					

X2026WR-2xXXDR-LPSN	LCP	Brass	X2026H
PART NO	Material	Material(Pin)	Suitable XKB Housing

DSND	SCALE: N/A	MODEL TYPE: 2.0mm Crimp Style Connector
DWN	VIEW:	PART NO.: X2026WR-2xXXDR-LPSN
CHKD	UNIT: mm/in	DWG NO.: X-X2026WR-2xXXDR-LPSN
APPD	SIZE: A4	WEIGHT SHEET REVISION
XKB INDUSTRIAL PRECISION CO.,LIMITED		1/1 A0

广东星坤科技股份有限公司

文件工程章

日期

REVISIONS

UNSPECIFIED TOLERANCES

www.helloxkb.com www.helloxkb.cn www.xk-dg.cn

MARK	DESCRIPTION	DATE	REVISED	APPROVED	ANGLAR	±5°
△					L ≤ 4	±0.2
△					4 < L ≤ 16	±0.3
△					16 < L ≤ 63	±0.4
△					L > 63	±0.5



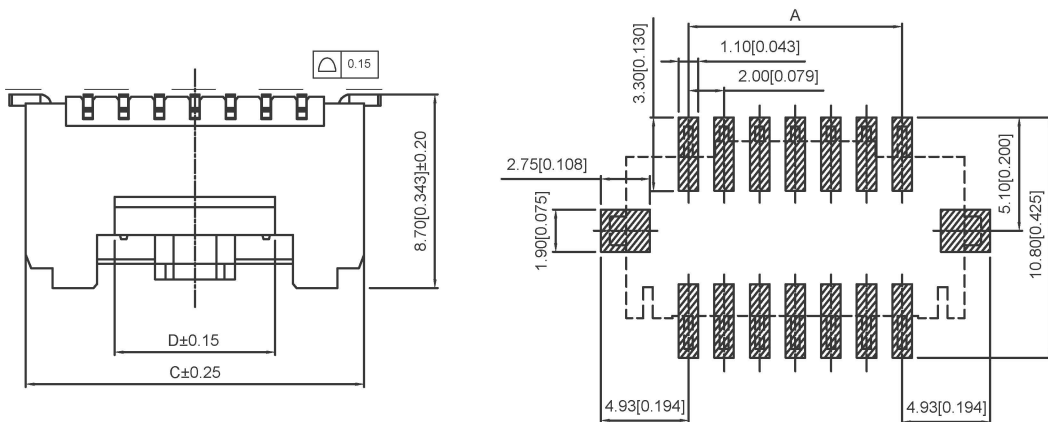

PCB LAYOUT(Tolerance: ±0.05)

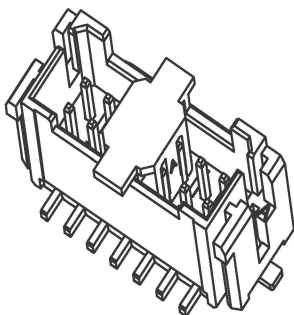
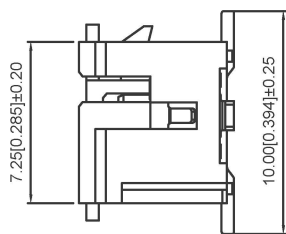
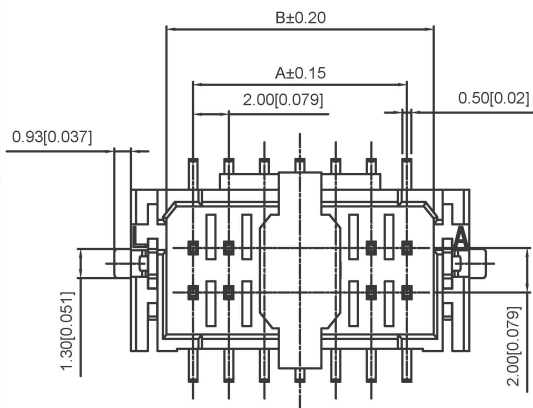

Specifications:

规格:

Voltage rating:250V AC/DC  
 额定电压: 250V AC/DC  
 Current rating:3A AC/DC  
 额定电流: 3A AC/DC  
 Withstanding voltage:1000V AC/minute  
 耐受电压: 1000V AC/分钟  
 Temperature range:-25℃~+85℃  
 温度范围: -25℃~+85℃  
 Insulation resistance:≥1000MΩ  
 绝缘电阻: ≥1000MΩ  
 Contact resistance:≤30mΩ  
 接触电阻: ≤30mΩ  
 After environmental testing:≤50mΩ  
 环境测试后: ≤50兆欧

X2026 W V S-2xXXD- LPSW

① ② ③ ④ ⑤ ⑥ ⑦ ⑧

- 1.Series No
- 2.Category:W-WAFER
- 3.Welding Board Angle:V-Straight 90°
- 4.Welding Way:S-SMT
- 5.Row No-Pin No:2xXX-2x02P~2x30P
- 6.Plug the Pin&Special NO:  
D-With Lock in the middle
- 7.Material:LP-LCP 94V-0
- 8.Plating Category:SW-Fog Tin Plating

poles	Dimensions(mm)				poles	Dimensions(mm)			
	A	B	C	D		A	B	C	D
2x02	2.00	5.00	9.00	3.00	2x10	18.00	21.00	25.00	15.00
2x03	4.00	7.00	11.00	3.00	2x11	20.00	23.00	27.00	17.00
2x04	6.00	9.00	13.00	3.00	2x12	22.00	25.00	29.00	19.00
2x05	8.00	11.00	15.00	5.00	2x13	24.00	27.00	31.00	21.00
2x06	10.00	13.00	17.00	7.00	2x14	26.00	29.00	33.00	23.00
2x07	12.00	15.00	19.00	9.00	2x15	28.00	31.00	35.00	25.00
2x08	14.00	17.00	21.00	11.00	2x16	30.00	33.00	37.00	27.00
2x09	16.00	19.00	23.00	13.00					

X2026VWS-2xXXD-LPSW	LCP UL 94V-0	Brass	Tin-Plated	X2026H-D
PART NO	Material	Material(pin)	Finish(Pin)	Suitable XKB Terminal

广东星坤科技股份有限公司

生	日期
效	
效	
效	
MARK	文件工程章

DATE	REVISED	APPROVED	UNSPECIFIED TOLERANCES

DSND	DATE	SCALE: N/A	MODEL TYPE: Wire to board connector
DWN	DATE	VIEW:	PART NO.: 2.00mm Crimp Style Connectors
CHKD	DATE	UNIT: mm/in	DWG NO.: X2026VWS-2xXXD-LPSW
APPD	DATE	SIZE: A4	WEIGHT SHEET REVISION 1.0g 1/1 A0
XKB INDUSTRIAL PRECISION CO., LIMITED			

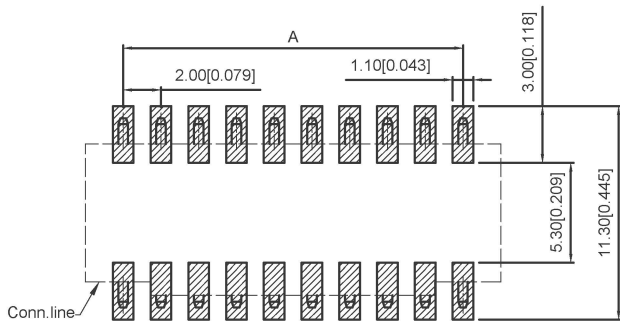
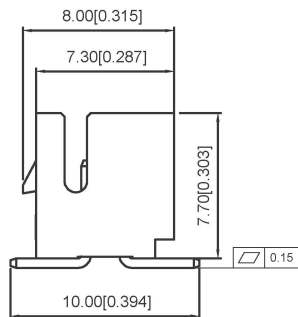
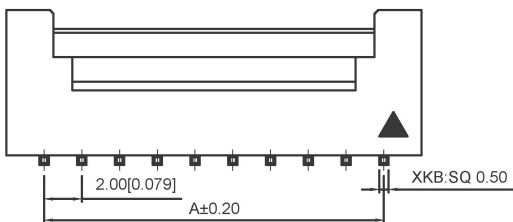
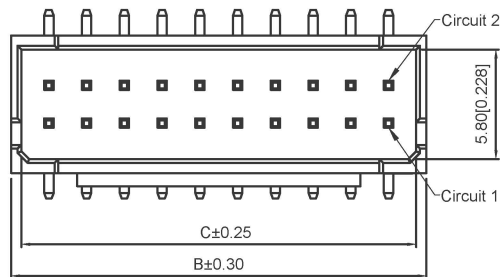

Specifications:

规格:

Voltage rating:250V AC/DC

额定电压: 250V AC/DC

Current rating:3A AC/DC

额定电流: 3A AC/DC

Withstanding voltage:1000V AC/minute

耐受电压: 1000V AC/分钟

Temperature range:-25℃~+85℃

温度范围: -25℃~+85℃

Insulation resistance:≥1000MΩ

绝缘电阻: ≥1000MΩ

Contact resistance:≤30mΩ

接触电阻: ≤30mΩ

After environmental testing:≤50mΩ

环境测试后: ≤50兆欧

X2026 W V S-2xXXD1-46SN

① ② ③ ④ ⑤ ⑥ ⑦ ⑧

- 1.Series No
- 2.Category:W-WAFER
- 3.Welding Board Angle:V-Straight 180°
- 4.Welding Way:S-SMT
- 5.Row No-Pin No:2xXX-2x02P~2x30P
- 6.Plug the Pin&Special NO:  
D1-With Lock in the middle
- 7.Material:46-PA46 94V-0
- 8.Plating Category:SN-Bright Tin Plating

poles	Dimensions(mm)			poles	Dimensions(mm)			Poles	Dimensions(mm)		
	A	B	C		A	B	C		A	B	C
2x02	2.00	6.00	4.90	2x10	18.00	22.00	20.90	2x18	34.00	38.00	36.90
2x03	4.00	8.00	6.90	2x11	20.00	24.00	22.90	2x19	36.00	40.00	38.90
2x04	6.00	10.00	8.90	2x12	22.00	26.00	24.90	2x20	38.00	42.00	40.90
2x05	8.00	12.00	10.90	2x13	24.00	28.00	26.90	2x30	58.00	62.00	60.90
2x06	10.00	14.00	12.90	2x14	26.00	30.00	28.90				
2x07	12.00	16.00	14.90	2x15	28.00	32.00	30.90				
2x08	14.00	18.00	16.90	2x16	30.00	34.00	32.90				
2x09	16.00	20.00	18.90	2x17	32.00	36.00	34.90				

X2026VWS-2xXXD1-46SN	PA46 94V-0	Brass	Tin-Plated	X2026H-D
PART NO	Material	Material(pin)	Finish(Pin)	Suitable XKB Terminal

广东星坤科技股份有限公司  
Recommended Pin Layout  
General Tolerance±0.05

生	日期					units: mm	
ΔX						tolerance: X.X ±0.2mm	
ΔX						X.XX ±0.1mm	
ΔX						X.XXX ±0.05mm	
MARK	文件工程章	DESCRIPTION	DATE	REVISED	APPROVED	UNSPECIFIED TOLERANCES	
		REVISIONS					
		www.xk-dg.cn	www.helloxkb.com				www.helloxkb.cn

DSND		DATE		SCALE: N/A	MODEL TYPE: Wire to board connector	
DWN		DATE		VIEW:	PART NO.: 2.00mm Crimp Style Connectors	
CHKD		DATE		UNIT: mm/in	DWG NO.: X2026VWS-2xXXD1-9TSN	
APPD		DATE		SIZE: A4		
XKB INDUSTRIAL PRECISION CO., LIMITED				WEIGHT	SHEET	REVISION
				1.0g	1/1	A0

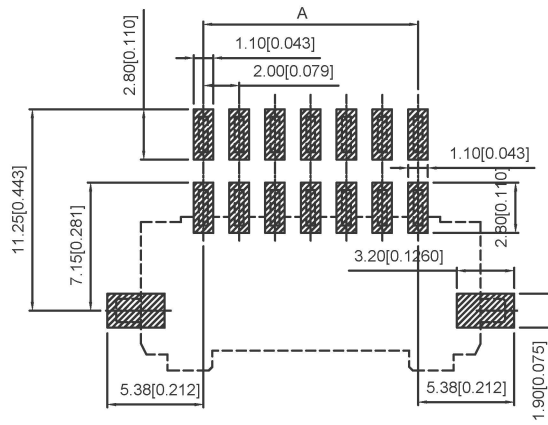
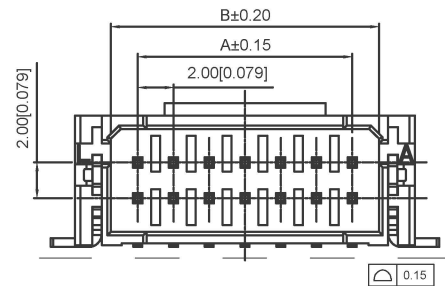
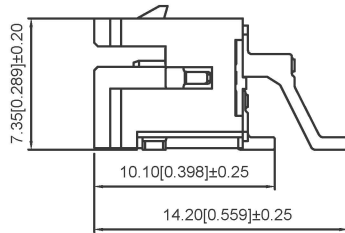
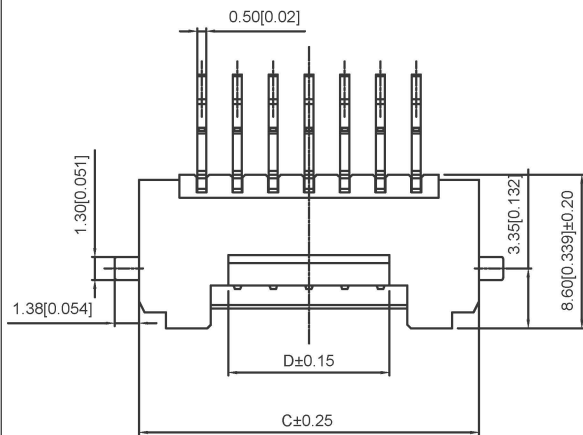

PCB LAYOUT(Tolerance:±0.05)

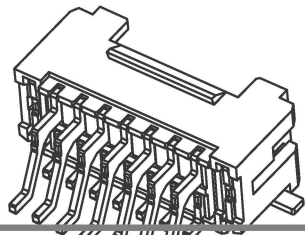

Specifications:

规格:  
 Voltage rating:250V AC/DC  
 额定电压: 250V AC/DC  
 Current rating:3A AC/DC  
 额定电流: 3A AC/DC  
 Withstanding voltage:1000V AC/minute  
 耐受电压: 1000V AC/分钟  
 Temperature range:-25°C~+85°C  
 温度范围: -25°C~+85°C  
 Insulation resistance:≥1000MΩ  
 绝缘电阻: ≥1000MΩ  
 Contact resistance:≤30mΩ  
 接触电阻: ≤30mΩ  
 After environmental testing:≤50mΩ  
 环境测试后: ≤50兆欧

X2026 W R S-2xXXD- LPSW

① ② ③ ④ ⑤ ⑥ ⑦ ⑧

- 1.Series No
- 2.Category:W-WAFER
- 3.Welding Board Angle:R-Right Angle 90°
- 4.Welding Way:S-SMT
- 5.Row No-Pin No:2xXX-2x02P~2x16P
- 6.Plug the Pin&Special NO:  
D-With Lock in the middle
- 7.Material:LP-LCP 94V-0
- 8.Plating Category:SW-Fog Tin Plating

poles	Dimensions(mm)				poles	Dimensions(mm)			
	A	B	C	D		A	B	C	D
2x02	2.00	5.00	9.00	3.00	2x10	18.00	21.00	25.00	15.00
2x03	4.00	7.00	11.00	3.00	2x11	20.00	23.00	27.00	17.00
2x04	6.00	9.00	13.00	3.00	2x12	22.00	25.00	29.00	19.00
2x05	8.00	11.00	15.00	5.00	2x13	24.00	27.00	31.00	21.00
2x06	10.00	13.00	17.00	7.00	2x14	26.00	29.00	33.00	23.00
2x07	12.00	15.00	19.00	9.00	2x15	28.00	31.00	35.00	25.00
2x08	14.00	17.00	21.00	11.00	2x16	30.00	33.00	37.00	27.00
2x09	16.00	19.00	23.00	13.00					

X2026WRS-2xXXD-LPSW	LCP UL 94-V0	Brass	Tin-Plated	X2026H-D
PART NO	Material	Material(pin)	Finish(Pin)	Suitable XKB Terminal

广东星坤科技股份有限公司

生	日期						units: mm
效							tolerance:
ΔX							X.X ±0.2mm
ΔX							X.XX ±0.1mm
MARK							X.XXX ±0.05mm
文件工程章	DESCRIPTION	DATE	REVISED	APPROVED			UNSPECIFIED TOLERANCES
	REVISIONS						
	www.xk-dg.cn	www.helloxkb.com	www.helloxkb.cn				

DSND		DATE		SCALE: N/A	MODEL TYPE: Wire to board connector	
DWN		DATE		VIEW:	PART NO.: 2.00mm Crimp Style Connectors	
CHKD		DATE		UNIT: mm/in	DWG NO.: X2026WRS-2xXXD-LPSW	
APPD		DATE		SIZE: A4		
XKB INDUSTRIAL PRECISION CO., LIMITED				WEIGHT	SHEET	REVISION
				1.0g	1/1	A0

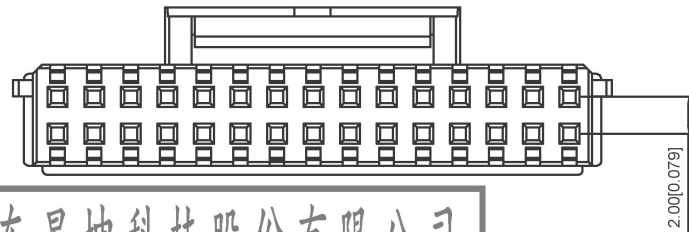
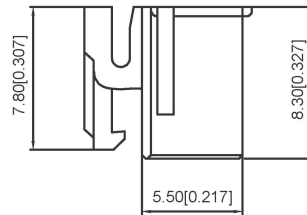
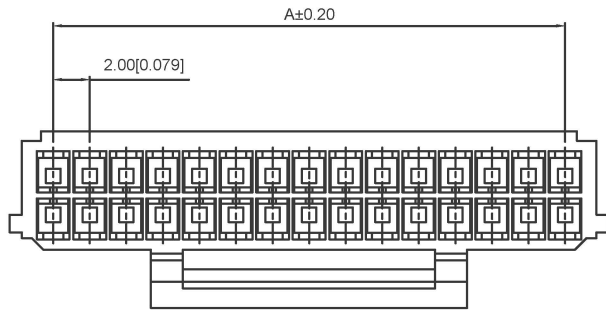

**Specifications:**

规格:  
 Voltage rating:250V AC/DC  
 额定电压: 250V AC/DC  
 Current rating:3A AC/DC  
 额定电流: 3A AC/DC  
 Withstanding voltage:1000V AC/minute  
 耐受电压: 1000V AC/分钟  
 Temperature range:-25℃~+85℃  
 温度范围: -25℃~+85℃  
 Insulation resistance:≥1000MΩ  
 绝缘电阻: ≥1000MΩ  
 Contact resistance:≤30mΩ  
 接触电阻: ≤30mΩ  
 After environmental testing:≤50mΩ  
 环境测试后: ≤50兆欧

X2026 H X- 2xXX D-N0 XX

① ② ③ ④ ⑤ ⑥ ⑦

- 1.Series No
- 2.Category:H-HSG
- 3.Appearance type:Blank-Ordinary
- 4.Row No-Pin No:2xXX-2x02P~2x16P
- 5.Plug the Pin&Special N0:  
D-With Lock in the middle
- 6.Material:N0-PA66 94V-0
- 7.Color:Blank-Natural Color

poles	Dimensions(mm)			poles	Dimensions(mm)			poles	Dimensions(mm)		
	A	B	C		A	B	C		A	B	C
2x02	2.00	4.60	6.76	2x10	18.00	20.60	22.76	2x18	34.00	36.60	38.76
2x03	4.00	6.60	8.76	2x11	20.00	22.60	24.76	2x19	36.00	38.60	40.76
2x04	6.00	8.60	10.76	2x12	22.00	24.60	26.76	2x20	38.00	40.60	42.76
2x05	8.00	10.60	12.76	2x13	24.00	26.60	28.76				
2x06	10.00	12.60	14.76	2x14	26.00	28.60	30.76				
2x07	12.00	14.60	16.76	2x15	28.00	30.60	32.76				
2x08	14.00	16.60	18.76	2x16	30.00	32.60	34.76				
2x09	16.00	18.60	20.76	2x17	32.00	34.60	36.76				

X2026H-2xXXD-N0	Nylon 66 UL 94-V0	X2026T-D	X2026H-D
PART NO	Material	Suitable XKB Terminal	Suitable XKB Terminal

广东星坤科技股份有限公司

生	日期
效	
效	
效	
MARK	文件工程章

DATE	REVISED	APPROVED	units:	mm
			tolerance:	
			X.X	±0.2mm
			X.XX	±0.1mm
			X.XXX	±0.05mm
UNSPECIFIED TOLERANCES				

DSND		DATE		SCALE: N/A	MODEL TYPE: Wire to board connector
DWN		DATE		VIEW:	PART NO.:
CHKD		DATE		UNIT: mm/in	2.00mm Crimp Style Connectors
APPD		DATE		SIZE: A4	DWG NO.: X2026H-2xXXD-N0
XKB INDUSTRIAL PRECISION CO., LIMITED					WEIGHT 1.0g
					SHEET 1/1
					REVISION A0



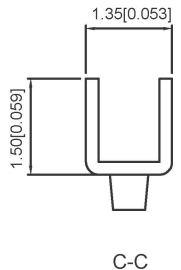
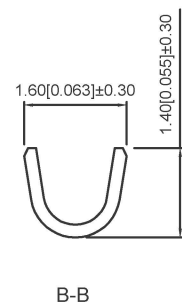
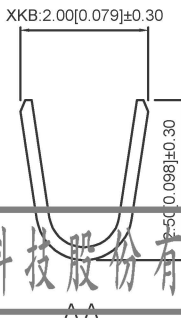
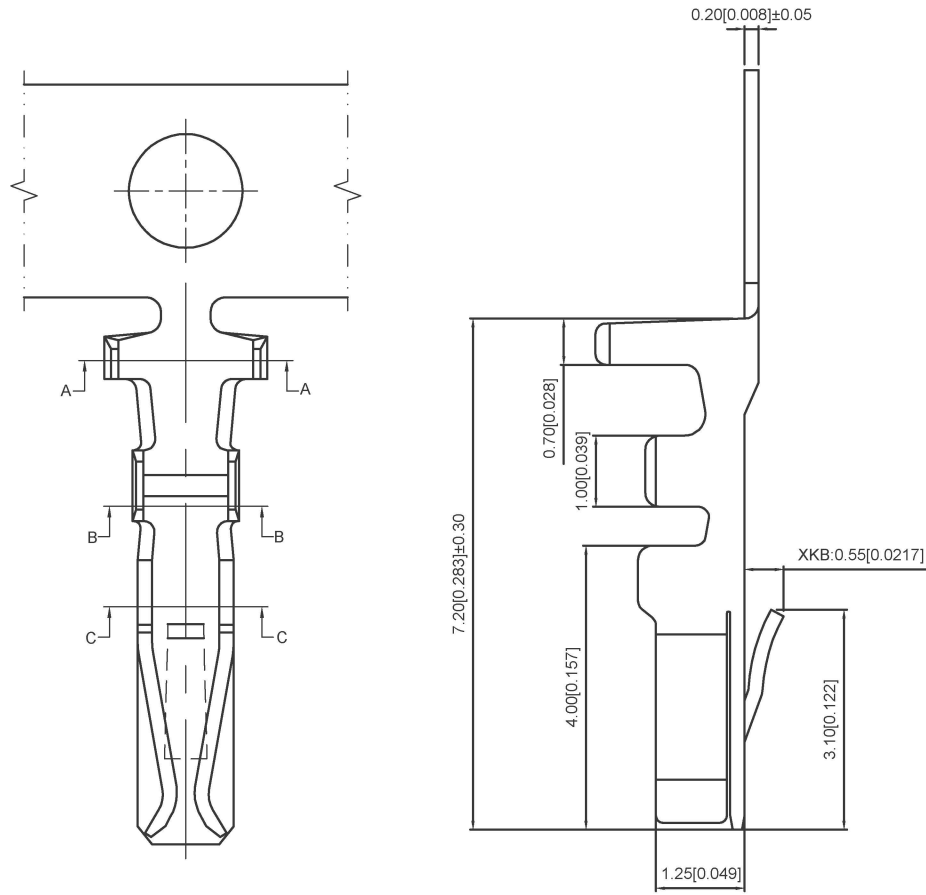

Specifications:  
 规格:  
 Voltage rating:250V AC/DC  
 额定电压: 250V AC/DC  
 Current rating:3A AC/DC  
 额定电流: 3A AC/DC  
 Withstanding voltage:1000V AC/minute  
 耐受电压: 1000V AC/分钟  
 Temperature range:-25°C~+85°C  
 温度范围: -25°C~+85°C  
 Insulation resistance:≥1000MΩ  
 绝缘电阻: ≥1000MΩ  
 Contact resistance:≤30mΩ  
 接触电阻: ≤30mΩ  
 After environmental testing:≤50mΩ  
 环境测试后: ≤50兆欧

X2026 T X - P SN X - D  
 ① ② ③ ④ ⑤ ⑥ ⑦

- 1.Series Number
- 2.Category:T-terminal
- 3.Appearance type:Blank-Ordinary
- 4.Material:P-Phosphor bronze
- 5.Plating style:
- 6.SN-Bright tin plating;G03-Contact Gold Plating 3u"
- 7.Plating method:Blank-Stamping before plating  
 Mold No/Mark/Special No:  
 D-Mating 2026H-2x08D Series Following Housing

poles	Dimensions(mm)			poles	Dimensions(mm)			poles	Dimensions(mm)		
	A	B	C		A	B	C		A	B	C
2x02	2.00	4.60	6.76	2x10	18.00	20.60	22.76	2x18	34.00	36.60	38.76
2x03	4.00	6.60	8.76	2x11	20.00	22.60	24.76	2x19	36.00	38.60	40.76
2x04	6.00	8.60	10.76	2x12	22.00	24.60	26.76	2x20	38.00	40.60	42.76
2x05	8.00	10.60	12.76	2x13	24.00	26.60	28.76				
2x06	10.00	12.60	14.76	2x14	26.00	28.60	30.76				
2x07	12.00	14.60	16.76	2x15	28.00	30.60	32.76				
2x08	14.00	16.60	18.76	2x16	30.00	32.60	34.76				
2x09	16.00	18.60	20.76	2x17	32.00	34.60	36.76				

X2026T-PG03-D	Phosphor Bronze	AWG#22-28	1.60mm(Max)	Stamping Before plating;30u"MIN.Ni ;Contact3U"Au	X2026H-D
X2026T-PSN-D	Phosphor Bronze	AWG#22-28	1.60mm(Max)	Stamping Before plating;30u"MIN.Ni ;70u"Sn	X2026H-D
PART NO	Material	Wire Range	Insulation OD	Finish	Suitable XKB

广东星坤科技股份有限公司

生	日期
ΔX	ΔX
ΔX	ΔX
MARK	文件工程章
DESCRIPTION	REVISIONS
DATE	REVISED
APPROVED	UNSPECIFIED TOLERANCES
www.xk-dg.cn	www.helloxkb.com
www.helloxkb.com	

DSND	DATE	SCALE: N/A	MODEL TYPE: Wire to board connector
DWN	DATE	VIEW:	PART NO.:
CHKD	DATE	UNIT: mm/in	2.00mm Crimp Style Connectors
APPD	DATE	SIZE: A4	DWG NO.: X2026T-PXXX-D
XKB INDUSTRIAL PRECISION CO.,LIMITED			WEIGHT 1.0g
			SHEET 1/1
			REVISION A0

units:	mm
tolerance:	
X.X	±0.2mm
X.XX	±0.1mm
X.XXX	±0.05mm