

Specifications:

规格:
 Voltage rating:250V AC/DC
 额定电压: 250V AC/DC
 Current rating:3A AC/DC
 额定电流: 3A AC/DC
 Withstanding voltage:800V AC/minute
 耐受电压: 800V AC/分钟
 Temperature range:-25℃~+85℃
 温度范围: -25℃~+85℃
 Insulation resistance:≥1000MΩ
 绝缘电阻: ≥1000MΩ
 Contact resistance:≤10mΩ
 接触电阻: ≤10mΩ
 After environmental testing:≤20mΩ
 环境测试后: ≤20兆欧

X2026 W R X-2xXXB-N0SN XX

① ② ③ ④ ⑤ ⑥ ⑦ ⑧ ⑨

- 1.Series No
- 2.Category:W-WAFER
- 3.Welding Board Angle:R-Right Angle 90°
- 4.Welding Way:Blank-DIP
- 5.Row No-Pin No:2xXX-2x02P~2x22P
- 6.Plug the Pin&Special NO:
B-With Lock In the middle
- 7.Material:N0-PA66 94V-0
- 8.Plating Category:SN-Bright Tin Plating
- 9.Color:Blank-Natural Color

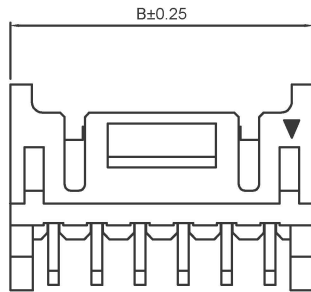

05P~13P Shape(Scale1:1)

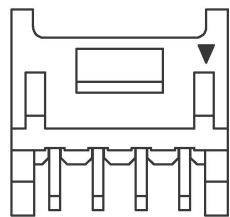
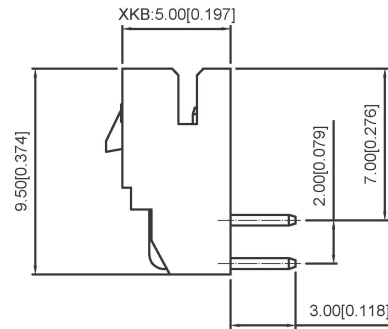

02P~04P Shape(Scale1:1)

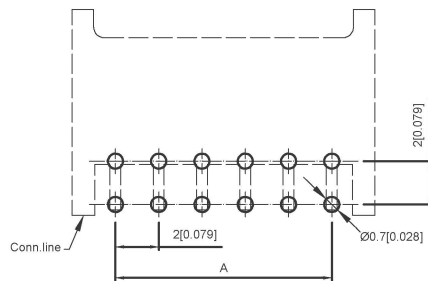

Recommended PCB Layout
 General Tolerance±0.05

poles	Dimensions(mm)			poles	Dimensions(mm)			Poles	Dimensions(mm)		
	A	B	C		A	B	C		A	B	C
2x02	2.00	6.00	4.70	2x10	18.00	22.00	20.70	2x18	34.00	38.00	36.70
2x03	4.00	8.00	6.70	2x11	20.00	24.00	22.70	2x19	36.00	40.00	38.70
2x04	6.00	10.00	8.70	2x12	22.00	26.00	24.70	2x20	38.00	42.00	40.70
2x05	8.00	12.00	10.70	2x13	24.00	28.00	26.70	2x21	40.00	44.00	42.70
2x06	10.00	14.00	12.70	2x14	26.00	30.00	28.70	2x22	42.00	46.00	44.70
2x07	12.00	16.00	14.70	2x15	28.00	32.00	30.70	2x23	44.00	48.00	46.70
2x08	14.00	18.00	16.70	2x16	30.00	34.00	32.70	2x24	46.00	50.00	48.70
2x09	16.00	20.00	18.70	2x17	32.00	36.00	34.70	2x25	48.00	52.00	50.70

X2026WR-2xXXB-N0 SN	PA66 UL 94V-0	Brass	Tin-Plated	X2026H-B
PART NO	Material	Material(pin)	Finish(Pin)	Suitable XKB Terminal

广东星坤科技股份有限公司

生	日期
效	
效	
效	
MARK	文件工程章

DATE	REVISED	APPROVED	units:	mm
			tolerance:	
			X.X	±0.2mm
			X.XX	±0.1mm
			X.XXX	±0.05mm
UNSPECIFIED TOLERANCES				

DSND	DATE	SCALE: N/A	MODEL TYPE: Wire to board connector
DWN	DATE	VIEW:	PART NO.:
CHKD	DATE	UNIT: mm/in	2.00mm Crimp Style Connectors
APPD	DATE	SIZE: A4	DWG NO.:
XKB INDUSTRIAL PRECISION CO., LIMITED			X2026WR-2xXXB-N0SN
WEIGHT	SHEET	REVISION	
1.0g	1/1	A0	

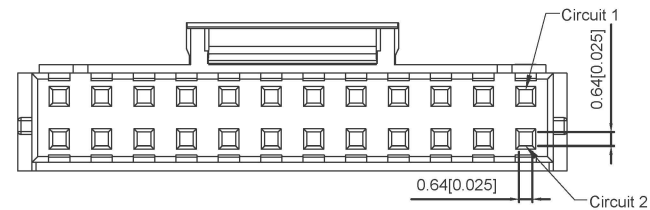
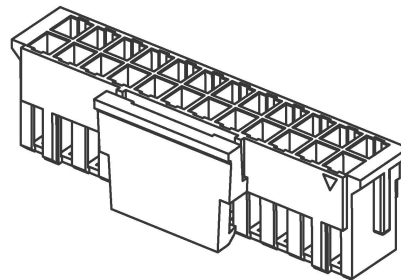
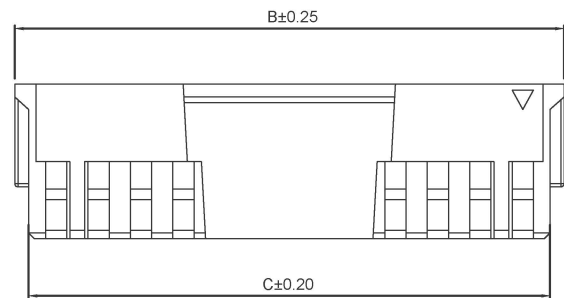
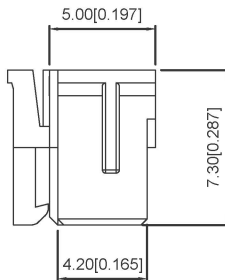
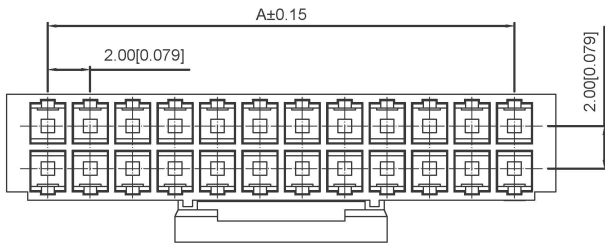

Specifications:

规格:
Voltage rating:250V AC/DC
 额定电压: 250V AC/DC
Current rating:3A AC/DC
 额定电流: 3A AC/DC
Withstanding voltage:800V AC/minute
 耐受电压: 800V AC/分钟
Temperature range:-25℃~+85℃
 温度范围: -25℃~+85℃
Insulation resistance:≥1000MΩ
 绝缘电阻: ≥1000MΩ
Contact resistance:≤10mΩ
 接触电阻: ≤10mΩ
After environmental testing:≤20mΩ
 环境测试后: ≤20兆欧

X2026 H X-2xXXB-N0XX

- ① ② ③ ④ ⑤ ⑥ ⑦

1. Series No
2. Category:H-HSG
3. Appearance type:Blank-Ordinary
4. Row No-Pin No:2xXX-2x02P~2x22P
5. Plug the Pin&Special NO:
B-With Lock In the middle
6. Material:N0-PA66 94V-0
7. Color:Blank-Natural Color;BK-Black

poles	Dimensions(mm)			poles	Dimensions(mm)			Poles	Dimensions(mm)		
	A	B	C		A	B	C		A	B	C
2x02	2.00	5.90	4.60	2x10	18.00	21.90	20.60	2x18	34.00	37.90	36.60
2x03	4.00	7.90	6.60	2x11	20.00	23.90	22.60	2x19	36.00	39.90	38.60
2x04	6.00	9.90	8.60	2x12	22.00	25.90	24.60	2x20	38.00	41.90	40.60
2x05	8.00	11.90	10.60	2x13	24.00	27.90	26.60	2x21	40.00	43.90	42.60
2x06	10.00	13.90	12.60	2x14	26.00	29.90	28.60	2x22	42.00	45.90	44.60
2x07	12.00	15.90	14.60	2x15	28.00	31.90	30.60				
2x08	14.00	17.90	16.60	2x16	30.00	33.90	32.60				
2x09	16.00	19.90	18.60	2x17	32.00	35.90	34.60				

X2026H-2xXXB-N0BK	Nylon 66 UL 94V-0(Black)	X2026T-B	X2026W-B
X2026H-2xXXB-N0	Nylon 66 UL 94V-0		
PART NO	Material	Suitable XKB Terminal	Suitable XKB Terminal

广东星坤科技股份有限公司

生	日期
效	
效	
效	
MARK	文件工程章

DATE	REVISED	APPROVED	units:	mm
			tolerance:	
			X.X	±0.2mm
			X.XX	±0.1mm
			X.XXX	±0.05mm
				UNSPECIFIED TOLERANCES

DSND		DATE		SCALE: N/A	MODEL TYPE: Wire to board connector	
DWN		DATE		VIEW:	PART NO.: 2.00mm Crimp Style Connectors	
CHKD		DATE		UNIT: mm/in	DWG NO.: X2026H-2xXXB-N0XX	
APPD		DATE		SIZE: A4		
KKB INDUSTRIAL PRECISION CO., LIMITED				WEIGHT	SHEET	REVISION
				1.0g	1/1	A0

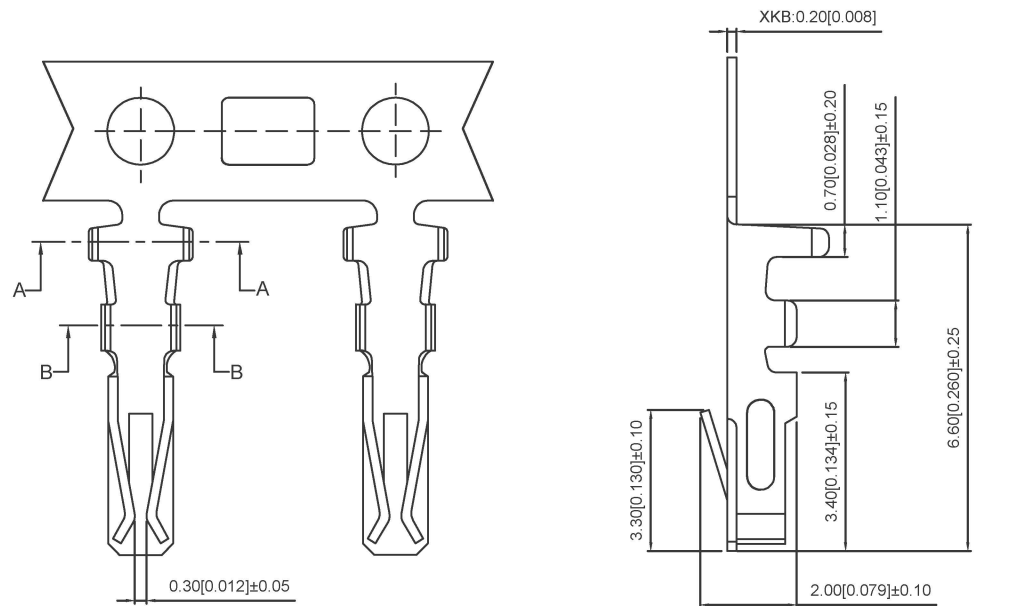

Specifications:

规格:
Voltage rating:250V AC/DC
 额定电压: 250V AC/DC
Current rating:3A AC/DC
 额定电流: 3A AC/DC
Withstanding voltage:800V AC/minute
 耐受电压: 800V AC/分钟
Temperature range:-25℃~+85℃
 温度范围: -25℃~+85℃
Insulation resistance:≥1000MΩ
 绝缘电阻: ≥1000MΩ
Contact resistance:≤10mΩ
 接触电阻: ≤10mΩ
After environmental testing:≤20mΩ
 环境测试后: ≤20兆欧

X2026 T X - P XXX X - B
 ① ② ③ ④ ⑤ ⑥ ⑦

1. Series Number
2. Category: T-terminal
3. Shape: Blank-Ordinary
4. Material: P-Phosphor bronze
5. Plating style: SN-Bright tin plating
6. Plating method: Blank-Stamping before plating
7. Mold No/Mark/Special No: B-With Lock In the middle

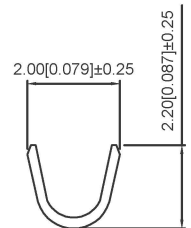

SEC:A-A

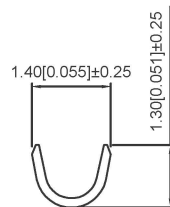

SEC:B-B

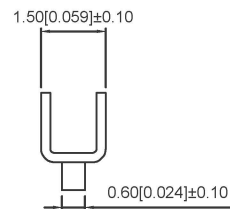

X2026T-PSN-B	Phosphor Bronze	AWG#22-28	1.5mm(Max)	Plating Before Stamping: 10u"Ni; 40~60u"Sn	X2026H-B
PART NO	Material	Wire Range	Insulation OD	Finish	Suitable XKB Terminal

广东星坤科技股份有限公司

生	日期
效	日期
效	日期
效	日期
MARK	文件工程章

units:	mm
tolerance:	
X.X	±0.2mm
X.XX	±0.1mm
X.XXX	±0.05mm
UNSPECIFIED TOLERANCES	

DSND	DATE	SCALE: N/A
DWN	DATE	VIEW:
CHKD	DATE	UNIT: mm/in
APPD	DATE	SIZE: A4
XKB INDUSTRIAL PRECISION CO., LIMITED		

MODEL TYPE: Wire to board connector		
PART NO.: 2.00mm Crimp Style Connectors		
DWG NO.: X2026T-PSN-B		
WEIGHT	SHEET	REVISION
1.0g	1/1	A0