

Specifications:
 规格:
 Voltage rating:250V AC/DC
 额定电压: 250V AC/DC
 Current rating:3A AC/DC
 额定电流: 3A AC/DC
 Withstanding voltage:800V AC/minute
 耐受电压: 800V AC/分钟
 Temperature range:-25℃~+85℃
 温度范围: -25℃~+85℃
 Insulation resistance:≥1000MΩ
 绝缘电阻: ≥1000MΩ
 Contact resistance:≤10mΩ
 接触电阻: ≤10mΩ
 After environmental testing:≤20mΩ
 环境测试后: ≤20兆欧

X2026 W V X-2xXXA-XX SN XX

① ② ③ ④ ⑤ ⑥ ⑦ ⑧ ⑨

- 1.Series No
- 2.Category:W-WAFER
- 3.Welding Board Angle:V-Straight 180°
- 4.Welding Way:Blank-DIP
- 5.Row No-Pin No:2xXX-2x02P~2x22P
- 6.Plug the Pin&Special NO:
A-With Lock on both side
- 7.Material:6T-PA6T 94V-0;N0-PA66 94V-0
- 8.Plating Category:SN-Bright Tin Plating
- 9.Color:Blank-Natural Color

poles	Dimensions(m m)		poles	Dimensions(m m)		Poles	Dimensions(m m)		Poles	Dimensions(m m)	
	A	B		A	B		A	B		A	B
2x02	2.00	8.00	2x09	16.00	22.00	2x16	30.00	36.00	2x23	44.00	50.00
2x03	4.00	10.00	2x10	18.00	24.00	2x17	32.00	38.00	2x24	46.00	52.00
2x04	6.00	12.00	2x11	20.00	26.00	2x18	34.00	40.00	2x25	48.00	54.00
2x05	8.00	14.00	2x12	22.00	28.00	2x19	36.00	42.00			
2x06	10.00	16.00	2x13	24.00	30.00	2x20	38.00	44.00			
2x07	12.00	18.00	2x14	26.00	32.00	2x21	40.00	46.00			
2x08	14.00	20.00	2x15	28.00	34.00	2x22	42.00	48.00			

X2026WV-2xXXA-6T SN	PA6T UL 94V-0	Brass	Tin-Plated	X2026H-A
X2026WV-2xXXA-N0 SN	PA66 UL 94V-0			X2026H-A
PART NO	Material	Material(pin)	Finish(Pin)	Suitable XKB Terminal

广东星坤科技股份有限公司

生	日期	DESCRIPTION	DATE	REVISED	APPROVED	units: mm
ΔX						tolerance:
ΔX						X.X ±0.2mm
ΔX						X.XX ±0.1mm
MARK						X.XXX ±0.05mm
文件工程章						UNSPECIFIED TOLERANCES
www.xk-dg.cn www.helloxkb.com www.helloxkb.cn						

DSND		DATE		SCALE: N/A	MODEL TYPE: Wire to board connector	
DWN		DATE		VIEW:	PART NO.: 2.00mm Crimp Style Connectors	
CHKD		DATE		UNIT: mm/in	DWG NO.: X2026WV-2xXXA-XXSN	
APPD		DATE		SIZE: A4		
KKB INDUSTRIAL PRECISION CO., LIMITED				WEIGHT	SHEET	REVISION
				1.0g	1/1	A0

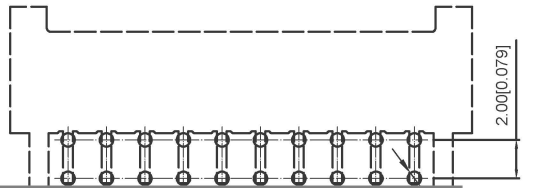
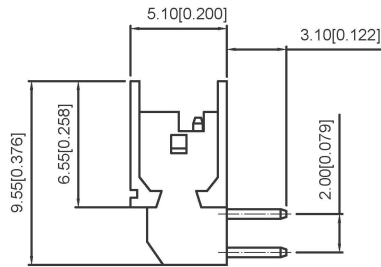
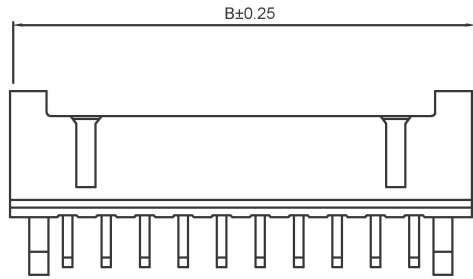
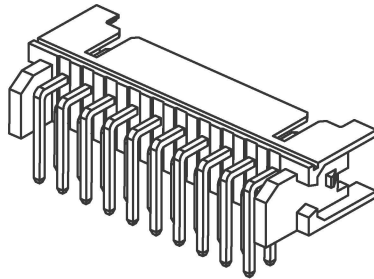
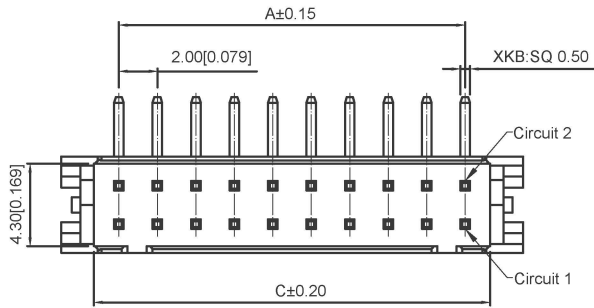

Specifications:

规格:
 Voltage rating:250V AC/DC
 额定电压: 250V AC/DC
 Current rating:3A AC/DC
 额定电流: 3A AC/DC
 Withstanding voltage:800V AC/minute
 耐受电压: 800V AC/分钟
 Temperature range:-25°C~+85°C
 温度范围: -25°C~+85°C
 Insulation resistance:≥1000MΩ
 绝缘电阻: ≥1000MΩ
 Contact resistance:≤10mΩ
 接触电阻: ≤10mΩ
 After environmental testing:≤20mΩ
 环境测试后: ≤20兆欧

X2026 W R-2xXX A- XX SN

① ② ③ ④ ⑤ ⑥ ⑦

- 1.Series No
- 2.Category:W-WAFER
- 3.Welding Board Angle:R-Right Angle 90°
- 4.Row No-Pin No:2xXX-2x02P~2x22P
- 5.Plug the Pin&Special NO:
A-With Lock on both side
- 6.Material:9T-PA9T 94V-0;N0-PA66 94V-0
- 7.Plating Category:SN-Bright Tin Plating

poles	Dimensions(mm)			poles	Dimensions(mm)			Poles	Dimensions(mm)		
	A	B	C		A	B	C		A	B	C
2x02	2.00	8.00	4.60	2x09	16.00	22.00	18.60	2x16	30.00	36.00	32.60
2x03	4.00	10.00	6.60	2x10	18.00	24.00	20.60	2x17	32.00	38.00	34.60
2x04	6.00	12.00	8.60	2x11	20.00	26.00	22.60	2x18	34.00	40.00	36.60
2x05	8.00	14.00	10.60	2x12	22.00	28.00	24.60	2x19	36.00	42.00	38.60
2x06	10.00	16.00	12.60	2x13	24.00	30.00	26.60	2x20	38.00	44.00	40.60
2x07	12.00	18.00	14.60	2x14	26.00	32.00	28.60				
2x08	14.00	20.00	16.60	2x15	28.00	34.00	30.60				

X2026WR-2xXXA-9T SN	PA9T UL 94V-0	Brass	Tin-Plated	X2026H-A
X2026WR-2xXXA-N0 SN	PA66 UL 94V-0			X2026H-A
PART NO	Material	Material(pin)	Finish(Pin)	Suitable XKB Terminal

广东星坤科技股份有限公司
 Recommended P.C.B Layout

General Tolerance±0.05

生	日期
效	
效	
效	
MARK	文件工程章

DATE	REVISED	APPROVED	units:	mm
			tolerance:	
			X.X	±0.2mm
			X.XX	±0.1mm
			X.XXX	±0.05mm
UNSPECIFIED TOLERANCES				

DSND		DATE		SCALE: N/A	MODEL TYPE: Wire to board connector
DWN		DATE		VIEW:	PART NO.:
CHKD		DATE		UNIT: mm/in	2.00mm Crimp Style Connectors
APPD		DATE		SIZE: A4	DWG NO.:
XKB INDUSTRIAL PRECISION CO., LIMITED					X2026WR-2xXXA-XXSN
			WEIGHT	SHEET	REVISION
			1.0g	1/1	A0

Specifications:

规格:

Voltage rating:250V AC/DC

额定电压: 250V AC/DC

Current rating:3A AC/DC

额定电流: 3A AC/DC

Withstanding voltage:800V AC/minute

耐受电压: 800V AC/分钟

Temperature range:-25°C~+85°C

温度范围: -25°C~+85°C

Insulation resistance: 1000MΩ min

绝缘电阻: 1000MΩ Min

Contact resistance:20mΩ Max

接触电阻: 20mΩ Max

X2026 W V S - 2xXX A - 6T SN
① ② ③ ④ ⑤ ⑥ ⑦ ⑧

- 1.Series No
- 2.Category:W-WAFER
- 3.Welding Board Angle:V-Straight 180°
- 4.Welding Way:S-SMT
- 5.Row No-Pin No:2xXX-2x02P~2x20P
- 6.Special NO:A-With Lock on both side
- 7.Material:6T-PA6T 94V-0
- 8.Plating Category:SN-Bright Tin Plating

Poles	Dimensions(mm)	
	A	B
2x02	2.00	8.00
2x03	4.00	10.00
2x04	6.00	12.00
2x05	8.00	14.00
2x06	10.00	16.00
2x07	12.00	18.00
2x08	14.00	20.00
2x09	16.00	22.00
2x10	18.00	24.00
2x11	20.00	26.00
2x12	22.00	28.00
2x20	38.00	44.00

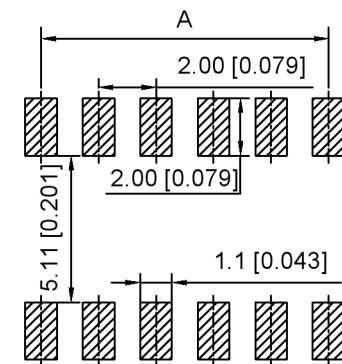
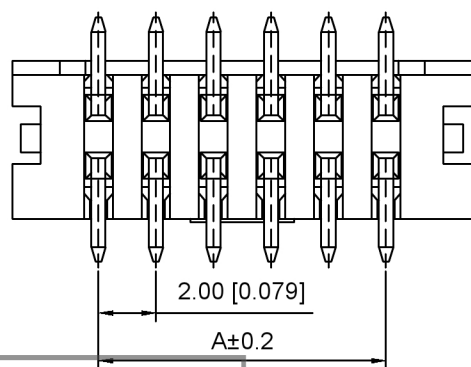
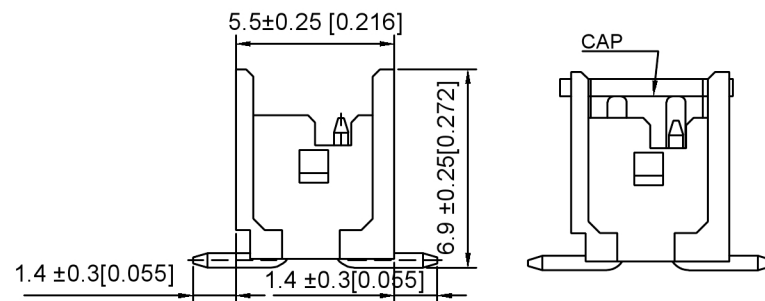
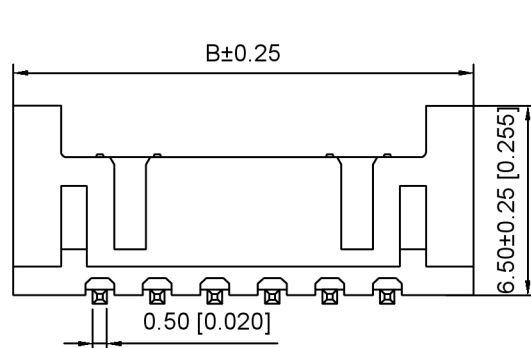
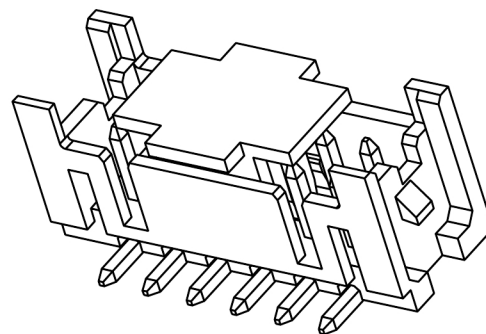
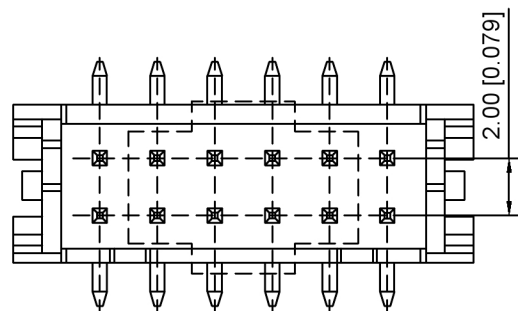

PCB LAYOUT

X2026WVS-2xXXA-6TSN	PA6T	Tin	X2026H
PART NO	Material	Plating	Suitable XKB Housing

DSND	SCALE: N/A	MODEL TYPE:		
DWN	VIEW:	2.00mm Crimp Style Connectors		
CHKD	UNIT: mm/in	PART NO.:		
APPD	SIZE: A4	X2026WVS-2xXXA-6TSN		
		DWG NO.:		
		X-X2026WVS-2xXXA-6TSN		
		WEIGHT	SHEET	REVISION
			1/1	A0

XKLB

XKB INDUSTRIAL PRECISION CO., LIMITED

ANGULAR	±5°
L ≤ 4	±0.2
4 < L ≤ 16	±0.3
16 < L ≤ 63	±0.4
L > 63	±0.5
UNSPECIFIED TOLERANCES	

广东星坤科技股份有限公司

MARK	DESCRIPTION	DATE	REVISED	APPROVED
Δ*				
Δx				
Δx				
文件工程章				

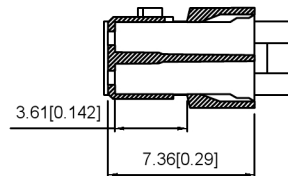
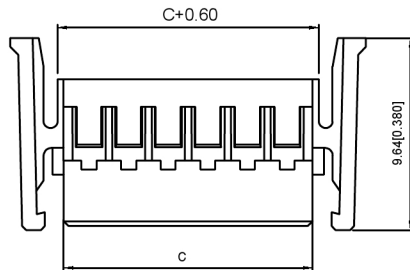
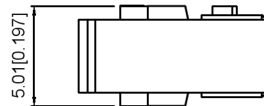
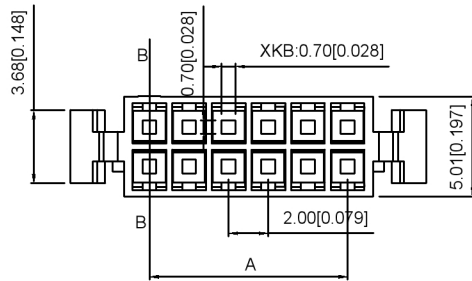
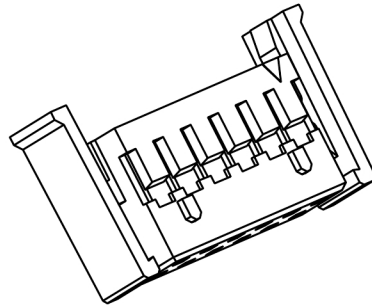
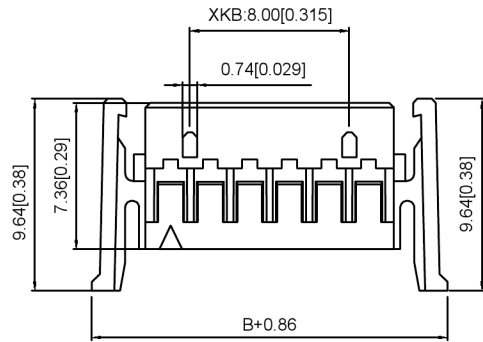

B-B

Specifications:

规格:
Voltage rating:250V AC/DC
 额定电压: 250V AC/DC
Current rating:3A AC/DC
 额定电流: 3A AC/DC
Withstanding voltage:800V AC/minute
 耐受电压: 800V AC/分钟
Temperature range:-25℃~+85℃
 温度范围: -25℃~+85℃
Insulation resistance:≥1000MΩ
 绝缘电阻: ≥1000MΩ
Contact resistance:≤10mΩ
 接触电阻: ≤10mΩ
After environmental testing:≤20mΩ
 环境测试后: ≤20兆欧

X2026 H X-2xXX AH-N0 XX

① ② ③ ④ ⑤ ⑥ ⑦

1. Series No
2. Category: H-HSG
3. Appearance type: Blank-Ordinary
4. Row No-Pin No: 2xXX-2x02P~2x22P
5. Plug the Pin&Special NO:
A-With Lock; H-High Salient Point
6. Material: N0-PA66 94V-0
7. Color: Blank-Natural Color

poles	Dimensions(mm)			poles	Dimensions(mm)			Poles	Dimensions(mm)		
	A	B	C		A	B	C		A	B	C
2x02	2.00	9.00	4.50	2x09	16.00	23.00	18.50	2x16	30.00	37.00	32.50
2x03	4.00	11.00	6.50	2x10	18.00	25.00	20.50	2x17	32.00	39.00	34.50
2x04	6.00	13.00	8.50	2x11	20.00	27.00	22.50	2x18	34.00	41.00	36.50
2x05	8.00	15.00	10.50	2x12	22.00	29.00	24.50	2x19	36.00	43.00	38.50
2x06	10.00	17.00	12.50	2x13	24.00	31.00	26.50	2x20	38.00	45.00	40.50
2x07	12.00	19.00	14.50	2x14	26.00	33.00	28.50				
2x08	14.00	21.00	16.50	2x15	28.00	35.00	30.50				

X2026H-2xXXAH-N0	Nylon 66 UL 94V-0	X2026T	X2026W-A
PART NO	Material	Suitable XKB Terminal	Suitable XKB Terminal

DSND		DATE		SCALE: N/A	MODEL TYPE: Wire to board connector
DWN		DATE		VIEW:	PART NO.:
CHKD		DATE		UNIT: mm/in	2.00mm Crimp Style Connectors
APPD		DATE		SIZE: A4	DWG NO.:
XKB INDUSTRIAL PRECISION CO.,LIMITED					X2026H-2xXXAH-N0
				WEIGHT	SHEET
				1.0g	1/1
				REVISION	A0

广东星坤科技股份有限公司

文件工程章

				units: mm
				tolerance:
				XX ±0.2mm
				X.XX ±0.1mm
				X.XXX ±0.05mm
UNSPECIFIED TOLERANCES				
REVISIONS	DATE	REVISED	APPROVED	
www.xk-dg.cn	www.helloxkb.com	www.helloxkb.cn		

Specifications:

规格:
 Voltage rating:250V AC/DC
 额定电压: 250V AC/DC
 Current rating:3A AC/DC
 额定电流: 3A AC/DC
 Withstanding voltage:800V AC/minute
 耐受电压: 800V AC/分钟
 Temperature range:-25℃-+85℃
 温度范围: -25℃-+85℃
 Insulation resistance:≥1000MΩ
 绝缘电阻: ≥1000MΩ
 Contact resistance:≤10mΩ
 接触电阻: ≤10mΩ
 After environmental testing:≤20mΩ
 环境测试后: ≤20兆欧

X2026 T - PS N-A

① ② ③ ④

- 1.Series Number
- 2.Category:T-terminal
- 3.Material:P-Phosphor bronze
- 4.Plating style:SN-Bright tin plating

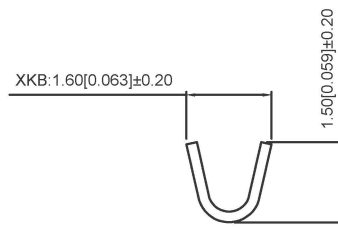
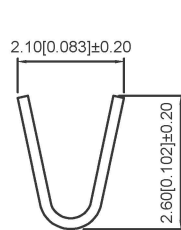
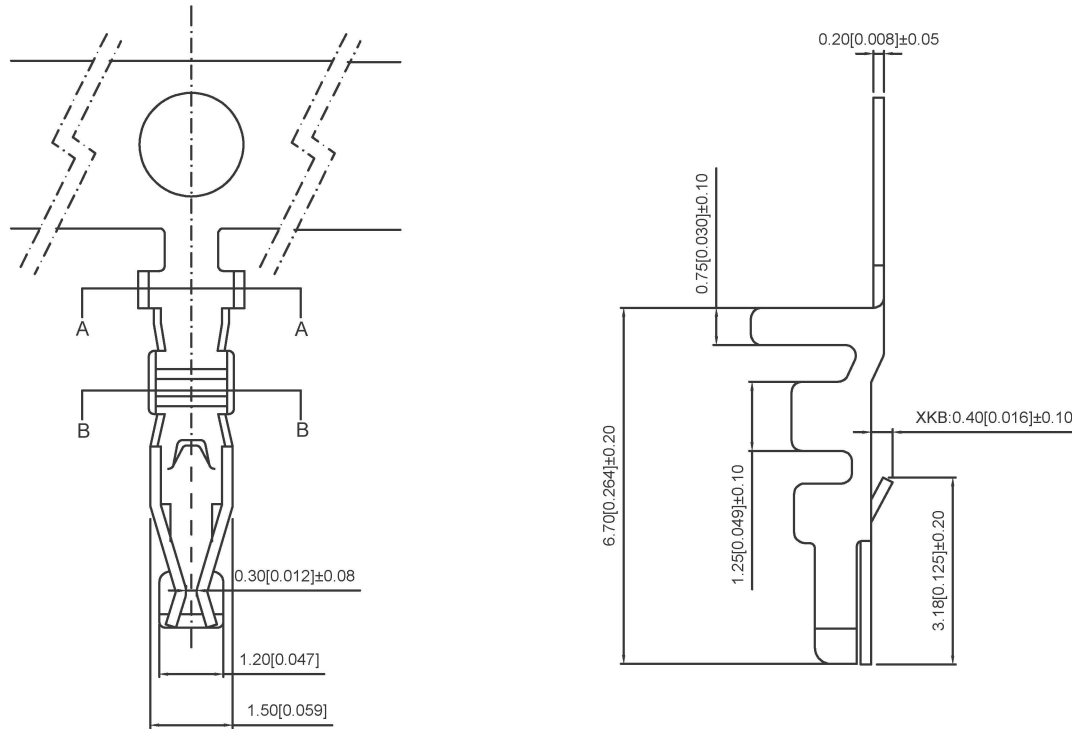
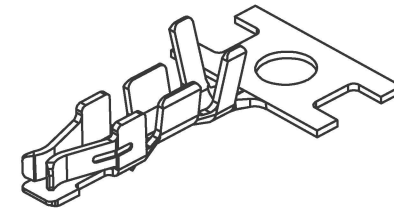

Section:B-B

X2026T-PSN-A	Phosphor Bronze	AWG#22-28	1.50mm(Max)	Stamping Before Plating:30u"MIN.Ni;70u"MIN.SN	X2026H
PART NO	Material	Wire Range	Insulation OD	Finish	Used In Cjst Housing

广东星坤科技股份有限公司

生	日期
效	
效	
效	
MARK	文件工程章

DESCRIPTION	DATE	REVISED	APPROVED	units: mm
REVISIONS				tolerance:
				X.X ±0.2mm
				X.XX ±0.1mm
				X.XXX ±0.05mm
				UNSPECIFIED TOLERANCES

DSND	DATE	SCALE: N/A
DWN	DATE	VIEW:
CHKD	DATE	UNIT: mm/in
APPD	DATE	SIZE: A4
KKB INDUSTRIAL PRECISION CO., LIMITED		

MODEL TYPE: Wire to board connector		
PART NO.: 2.00mm Crimp Style Connectors		
DWG NO.: X2026T-PSN-A		
WEIGHT 1.0g	SHEET 1/1	REVISION A0