

XKB

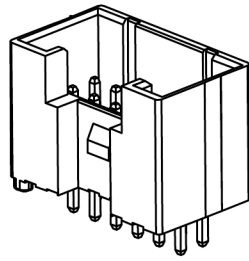

Specifications:

- Voltage rating: 250V AC/DC
- Current rating: 2.5-1.0A AC/DC
- Withstanding voltage: 800V AC/minute
- Temperature range: -25°C~+85°C
- Insulation resistance: ≥1000MΩ
- Contact resistance: ≤10mΩ
- After environmental testing: ≤20mΩ

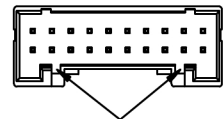
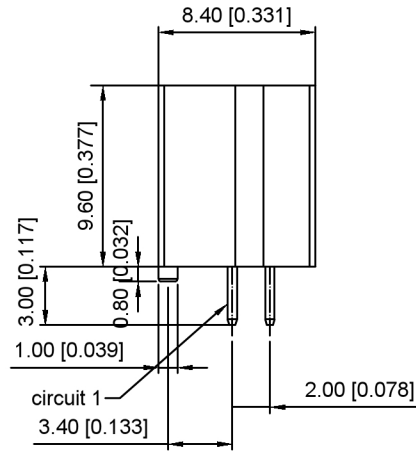
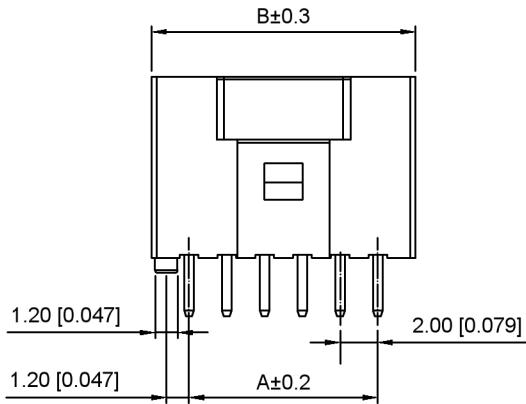

6P~14P Without Guideway
16P~40P With Guideway
Scale: 1/0.5

X2006 W V - 2*XX -4T SN

① ② ③ ④ ⑤ ⑥

- ① XKB Series No.
- ② Category: W-WAFER
- ③ Welding Board Angle: V-180°
- ④ Row No.-pin No.: 2*XX-04P~20P
- ⑤ Material: 4T-PA4T 94V-0
- ⑥ Plating Category : SN-Bright Tin Plating

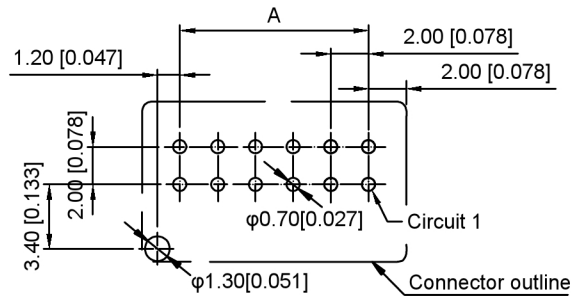

Recommended P.C.B Layout
General Tolerance ±0.05

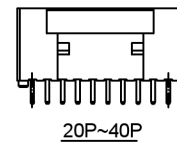
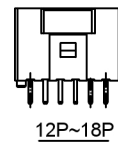
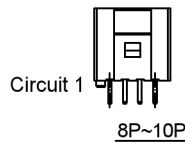

Poles	Dimensions(mm)		Poles	Dimensions(mm)	
	A	B		A	B
2*04	6.00	10.00	2*13	24.00	28.00
2*05	8.00	12.00	2*14	26.00	30.00
2*06	10.00	14.00	2*15	28.00	34.00
2*07	12.00	16.00	2*16	30.00	36.00
2*08	14.00	18.00	2*17	32.00	38.00
2*09	16.00	20.00	2*18	34.00	40.00
2*10	18.00	22.00	2*19	36.00	42.00
2*11	20.00	24.00	2*20	38.00	44.00
2*12	22.00	26.00			

Part No	Material	Suitable XKB Terminal	Suitable XKB Terminal
X2006W-2xXX-4TSN	PA4T UL 94V-0	X2006T	X2006H

广东星坤科技股份有限公司

日期
文件工程章

www.helloxkb.com

REVISIONS	DATE	REVISED	APPROVED	UNSPECIFIED TOLERANCES

DSND	DATE	SCALE: N/A	MODEL TYPE:
DWN	DATE	VIEW:	X2006W-2xXX-4TSN
CHKD	DATE	UNIT: mm/in	PART NO.:
APPD	DATE	SIZE: A4	DWG NO.:
XKB INDUSTRIAL PRECISION CO., LIMITED			WEIGHT
			SHEET
			REVISION
			1/1
			A0

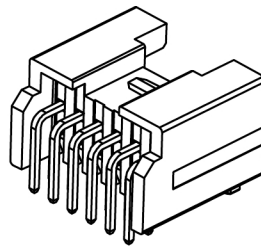
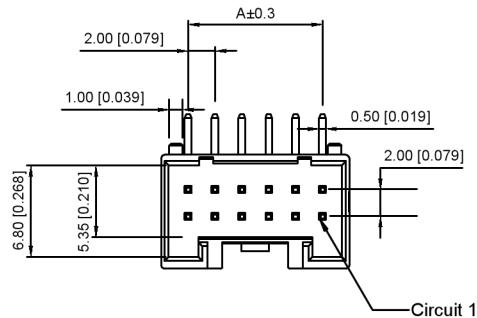

Specifications:

- Voltage rating: 250V AC/DC
- Current rating: 2.5-1.0A AC/DC
- Withstanding voltage: 800V AC/minute
- Temperature range: -25 °C ~ +85 °C
- Insulation resistance: ≥1000MΩ
- Contact resistance: ≤10mΩ
- After environmental testing: ≤20mΩ

X2006 W R - 2*XX -4T SN
 ① ② ③ ④ ⑤ ⑥

- ① XKB Series No.
- ② Category: W-WAFER
- ③ Welding Board Angle: R-90°
- ④ Row No. - pin No.: 2*XX-04P~20P
- ⑤ Material: 4T-PA4T 94V-0
- ⑥ Plating Category : SN-Bright Tin Plating

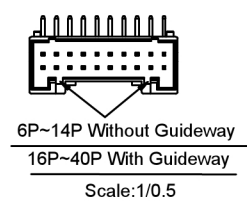
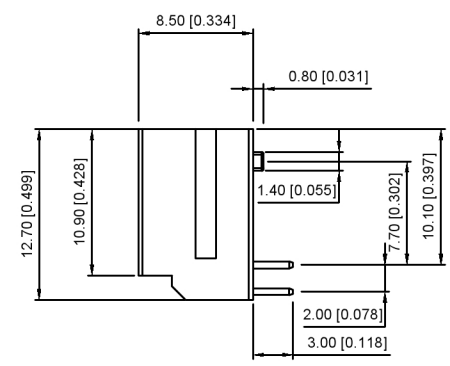
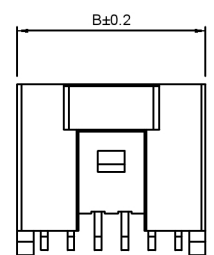

Poles	Dimensions(mm)		Poles	Dimensions(mm)	
	A	B		A	B
2*04	6.00	10.00	2*13	24.00	28.00
2*05	8.00	12.00	2*14	26.00	30.00
2*06	10.00	14.00	2*15	28.00	34.00
2*07	12.00	16.00	2*16	30.00	36.00
2*08	14.00	18.00	2*17	32.00	38.00
2*09	16.00	20.00	2*18	34.00	40.00
2*10	18.00	22.00	2*19	36.00	42.00
2*11	20.00	24.00	2*20	38.00	44.00
2*12	22.00	26.00			

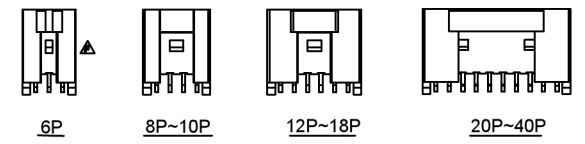
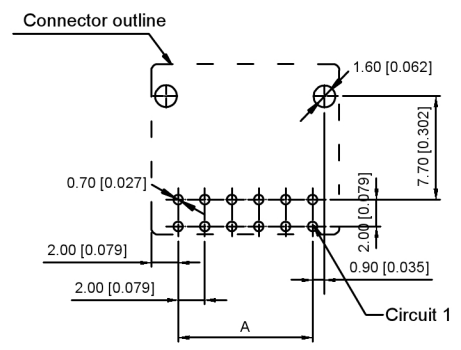

Recommended P.C.CB Layout
 General Tolerance ±0.05

X2006WR-2*XX-4TSN	PA4T UL 94V-0	X2006T	X2006H
PART NO	Material	Suitable XKB Terminal	Suitable XKB Terminal

广东星坤科技股份有限公司

ΔX		日期
生X		
ΔX		
知X		

文件工程章

				XKB	ANGLAR	±5°
					L ≤ 4	±0.2
					4 < L ≤ 16	±0.3
					16 < L ≤ 63	±0.4
					L > 63	±0.5
					UNSPECIFIED TOLERANCES	

DSND		DATE		SCALE: N/A	MODEL TYPE: X2006WR-2*XX-4TSN		
DWN		DATE		VIEW:	PART NO.:		
CHKD		DATE		UNIT: mm/in	DWG NO.:		
APPD		DATE		SIZE: A4			
KXB INDUSTRIAL PRECISION CO., LIMITED					WEIGHT	SHEET	REVISION
						1/1	A0

REVISIONS
 www.hellokxb.com

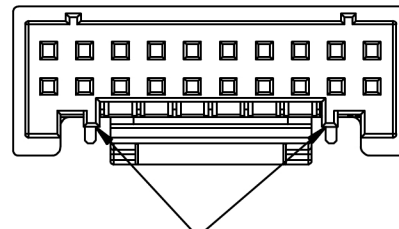
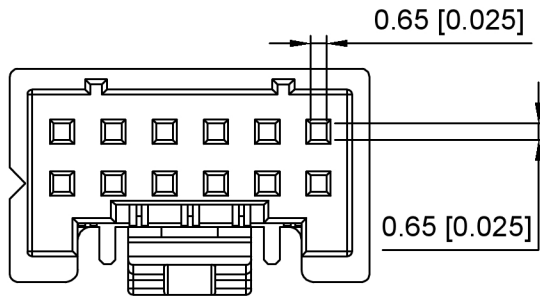
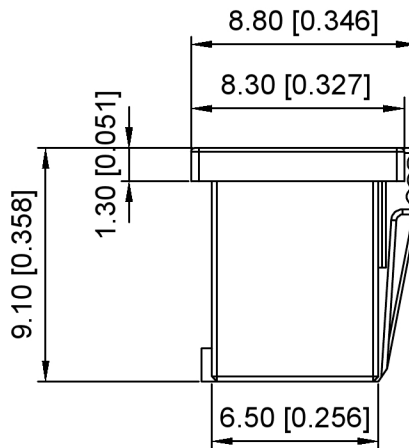
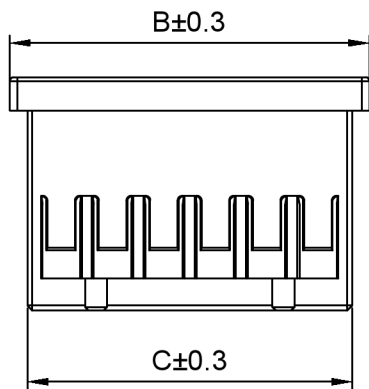
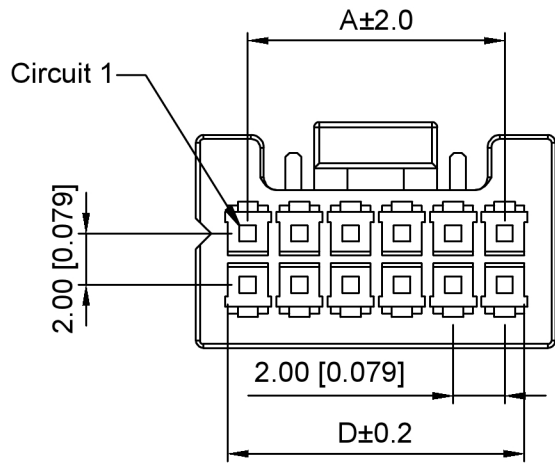

8P~14P Without Guide bulge
16P~40P With Guide bulge

Scale: 1/0.8

Specifications:

- Voltage rating: 250V AC/DC
- Current rating: 2.5-1.0A AC/DC
- Withstanding voltage: 800V AC/minute
- Temperature range: -25 °C~+85 °C
- Insulation resistance: ≥1000MΩ
- Contact resistance: ≤10mΩ
- After environmental testing: ≤20mΩ

X2006 H - 2*XX -N0 HF

① ② ③ ④ ⑤

- ① XKB Series No.
- ② Category: H-HSG
- ③ Row No.-pin No.: 2*XX-04P~20P
- ④ Material: N0-PA66 94V-0
- ⑤ HF-Halogen free

Poles	Dimensions(mm)				Poles	Dimensions(mm)			
	A	B	C	D		A	B	C	D
2*04	6.00	10.00	8.65	7.55	2*13	24.00	28.00	26.65	25.55
2*05	8.00	12.00	10.65	9.55	2*14	26.00	30.00	28.65	27.55
2*06	10.00	14.00	12.65	11.55	2*15	28.00	32.00	30.65	29.55
2*07	12.00	16.00	14.65	13.55	2*16	30.00	34.00	32.65	31.55
2*08	14.00	18.00	16.65	15.55	2*17	32.00	36.00	34.65	33.55
2*09	16.00	20.00	18.65	17.55	2*18	34.00	38.00	36.65	35.55
2*10	18.00	22.00	20.65	19.55	2*19	36.00	40.00	38.65	37.55
2*11	20.00	24.00	22.65	21.55	2*20	38.00	42.00	40.65	39.55
2*12	22.00	26.00	24.65	23.55					

X2006H-2*XX-N0HF	PA66 UL 94V-0	X2006T	X2006W
PART NO	Material	Suitable XKB Terminal	Suitable XKB Terminal

DSND	DATE	SCALE: N/A	MODEL TYPE: X2006H-2*XX-N0HF
DWN	DATE	VIEW:	PART NO.:
CHKD	DATE	UNIT: mm/in	DWG NO.:
APPD	DATE	SIZE: A4	
XKB INDUSTRIAL PRECISION CO., LIMITED			WEIGHT
			SHEET 1/1
			REVISION A0

广东星坤科技股份有限公司

张致

MARK

日期

DESCRIPTION

文件工程章

REVISIONS

www.helloxkb.com

DATE REVISED APPROVED

XKB	ANGLAR	±5°
	L ≤ 4	±0.2
	4 < L ≤ 16	±0.3
	16 < L ≤ 63	±0.4
	L > 63	±0.5

UNSPECIFIED TOLERANCES

