

02~04P Single Hole
Scale 1:0.7

Specifications:

规格:
Voltage rating:150V AC/DC
额定电压: 150V AC/DC
Current rating:3A AC/DC
额定电流: 3A AC/DC
Withstanding voltage:500V AC/minute
耐受电压: 500V AC/分钟
Temperature range:-25℃~+85℃
温度范围: -25℃~+85℃
Insulation resistance:≥1000MΩ
绝缘电阻: ≥1000MΩ
Contact resistance:≤20mΩ
接触电阻: ≤20mΩ
After environmental testing:≤40mΩ
环境测试后: ≤40兆欧

X1503 W R S-XX XX-9T SN

① ② ③ ④ ⑤ ⑥ ⑦ ⑧

- 1.Series No.
- 2.Category:W-wafer
- 3.Welding Board Angle:R-Right Angle 90°
- 4.Welding Way:S-SMT
- 5.Row No-Pin No: XX-02P~12P
- 6.Plug the pin&special No
- 7.Material:9T PA94 94V-0
- 8.Planting style:SN-Bright tin plating

Poles	Dimensions(mm)	
	A	B
02	1.50	6.75
03	3.00	8.25
04	4.50	9.75
05	6.00	11.25
06	7.50	12.75
07	9.00	14.25
08	10.50	15.75
09	12.00	17.25
10	13.50	18.75
11	15.00	20.25
12	16.50	21.75

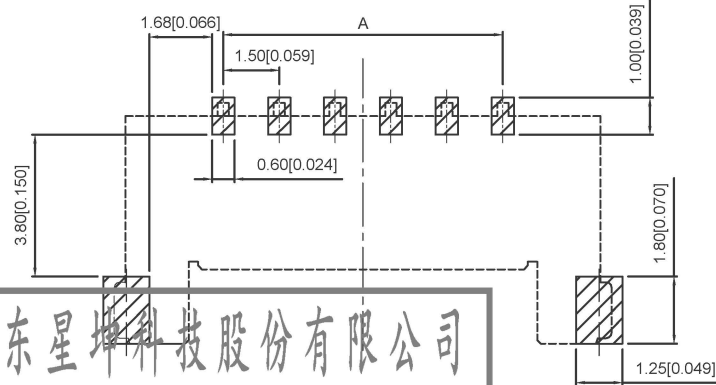
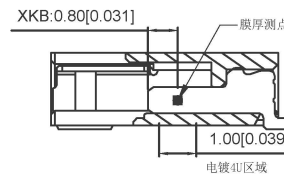
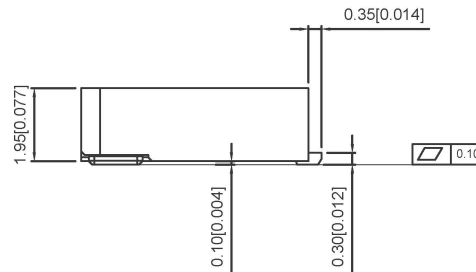
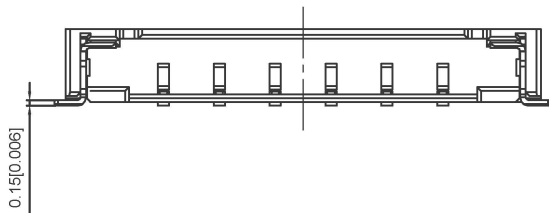
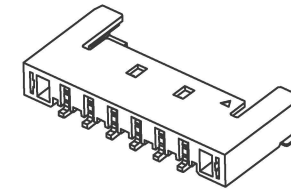

X1503WRS-XX-GTSN	Nylon 9T UL 94V-0	Brass	Tin-Plated	X1503H	1000PCS
PART NO	Material	Material(Pin)	Finish(Pin)	Suitable XKB Terminal	Qty/Reel

广东星坤科技股份有限公司

生效日期
文件工程章

DATE	REVISED	APPROVED	UNSPECIFIED TOLERANCES

DSND	DATE	SCALE: N/A	MODEL TYPE: Wire to board connector
DWN	DATE	VIEW:	PART NO.: 1.50mm Crimp Style Connectors
CHKD	DATE	UNIT: mm/in	DWG NO.: X1503WRS-XX-9TSN
APPD	DATE	SIZE: A4	WEIGHT 1.0g
KKB INDUSTRIAL PRECISION CO., LIMITED			SHEET 1/1
			REVISION A0

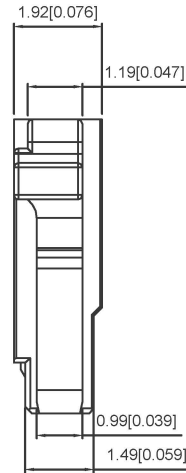
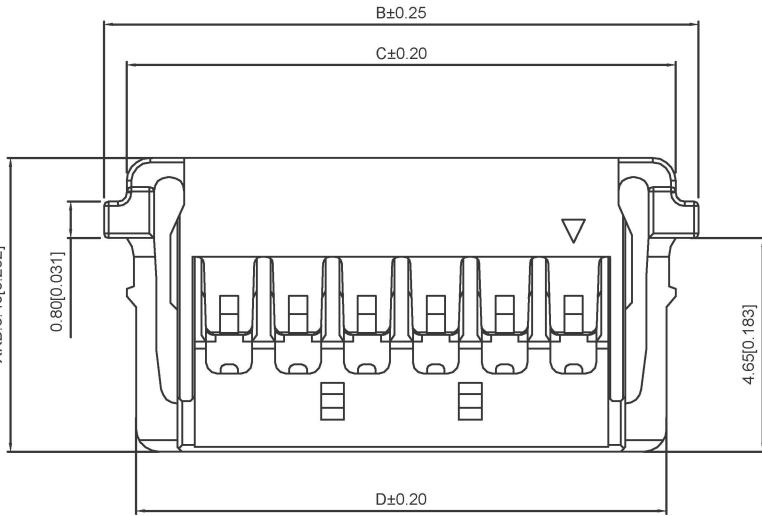
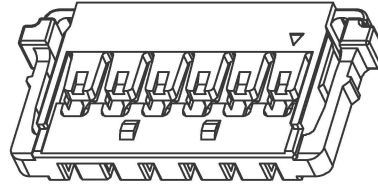

Specifications:

规格:

Voltage rating:150V AC/DC

额定电压: 150V AC/DC

Current rating:3A AC/DC

额定电流: 3A AC/DC

Withstanding voltage:500V AC/minute

耐受电压: 500V AC/分钟

Temperature range:-25℃~+85℃

温度范围: -25℃~+85℃

Insulation resistance:≥1000MΩ

绝缘电阻: ≥1000MΩ

Contact resistance:≤20mΩ

接触电阻: ≤20mΩ

After environmental testing:≤40mΩ

环境测试后: ≤40兆欧

X1503 H-XX-N0

① ② ③ ④

1. Series No.

2. Category:H-HSG

3. Row No-Pin No: XX-04P~12P

4. Material: N0-PA66 94V-0

Poles	Dimensions(mm)			
	A	B	C	D
02		6.95	5.95	5.55
03	3.00	8.45	7.45	7.05
04	4.50	9.95	8.95	8.55
05	6.00	11.45	10.45	10.05
06	7.50	12.95	11.95	11.55
07	9.00	14.45	13.45	13.05
08	10.50	15.95	14.95	14.55
09	12.00	17.45	16.45	16.05
10	13.50	18.95	17.95	17.55
11	15.00	20.45	19.45	19.05
12	16.50	21.95	20.95	20.55

X1503H-XX-N0	PA66 UL 94V-0	X1503T	X1503W
PART NO	Material	Suitable Terminal	Suitable XKB

广东星坤科技股份有限公司

生效	日期
ΔX	ΔX
ΔX	ΔX
MARK	文件工程章

										units: mm
										tolerance:
										X.X ±0.2mm
										X.XX ±0.1mm
										X.XXX ±0.05mm
										UNSPECIFIED TOLERANCES

DSND		DATE		SCALE: N/A	MODEL TYPE: Wire to board connector
DWN		DATE		VIEW:	PART NO.:
CHKD		DATE		UNIT: mm/in	1.50mm Crimp Style Connectors
APPD		DATE		SIZE: A4	DWG NO.: X1503H-XX-N0
KKB INDUSTRIAL PRECISION CO., LIMITED				WEIGHT	SHEET
				1.0g	1/1
				REVISION	A0

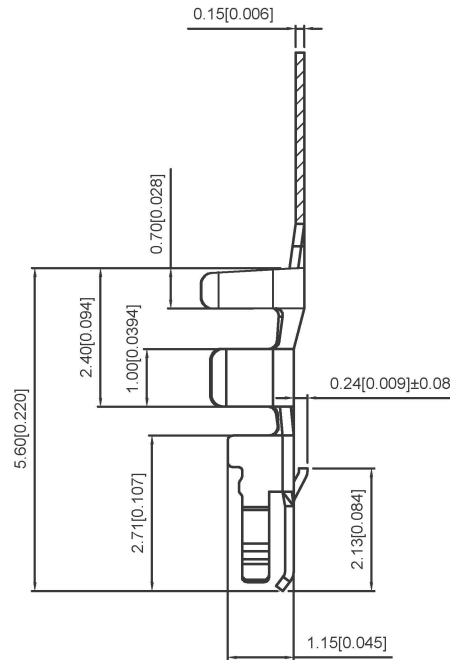
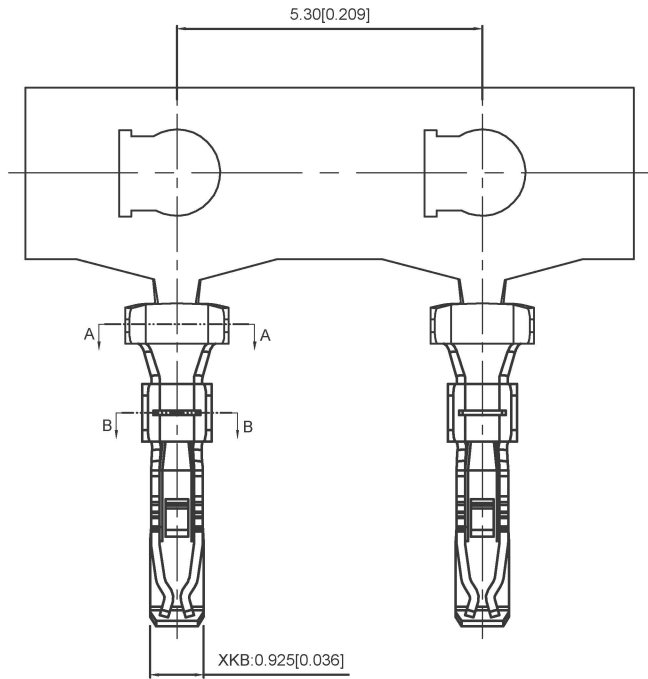

Specifications:

规格:
 Voltage rating:150V AC/DC
 额定电压: 150V AC/DC
 Current rating:3A AC/DC
 额定电流: 3A AC/DC
 Withstanding voltage:500V AC/minute
 耐受电压: 500V AC/分钟
 Temperature range:-25°C~+85°C
 温度范围: -25°C~+85°C
 Insulation resistance:≥1000MΩ
 绝缘电阻: ≥1000MΩ

Contact resistance:≤20mΩ
 接触电阻: ≤20mΩ
 After environmental testing:≤40mΩ
 环境测试后: ≤40mΩ
 Wire Range:#24-28
 电线范围: #24-28
 Insulation OD:1.10mm(Max)
 绝缘外径: 1.10mm (最大值)

X1503 T- P XX

- ① ② ③ ④

- 1.Series Number
- 2.Category:T-terminal
- 3.Material:P-Phosphor bronze
- 4.Plating Code:V01-Gold Flash
SN-Bright tin plating

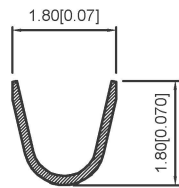

SECTION: A-A
SCALE: 1:1

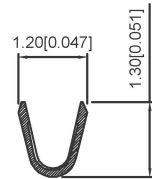

SECTION: B-B
SCALE: 1:1

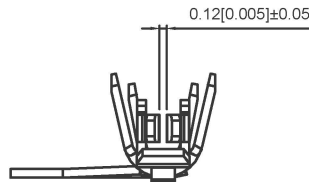

X1503T-PV01	Phosphor Bronze	AWG#24-28	1.10mm(Max)	Stamping Before Plating:30u"Ni MIN,Gold Flash	X1503H
X1503T-PSN				Stamping Before Plating:30u"Ni MIN,70u"Sn Min	
PART NO	Material	Wire Range	Insulation OD	Finish	Suitable: XKB

广东星坤科技股份有限公司

生	日期
效	日期
效	日期
效	日期
MARK	文件工程章

units:	mm
tolerance:	
X.X	±0.2mm
X.XX	±0.1mm
X.XXX	±0.05mm
UNSPECIFIED TOLERANCES	

DSND		DATE		SCALE: N/A	MODEL TYPE: Wire to board connector
DWN		DATE		VIEW:	PART NO.:
CHKD		DATE		UNIT: mm/in	1.50mm Crimp Style Connectors
APPD		DATE		SIZE: A4	DWG NO.: X1503T-PXXX
KKB INDUSTRIAL PRECISION CO.,LIMITED				WEIGHT	SHEET
				1.0g	1/1
				REVISION	A0