

Specifications:

规格:

Voltage rating:250V AC/DC

额定电压: 250V AC/DC

Current rating:1A AC/DC

额定电流: 1A AC/DC

Withstanding voltage:500V AC/minute

耐受电压: 500V AC/分钟

Temperature range:-40℃~+105℃

温度范围: -40℃~+105℃

Insulation resistance:≥1000MΩ

绝缘电阻: ≥1000MΩ

Contact resistance:≤20mΩ

接触电阻: ≤20mΩ

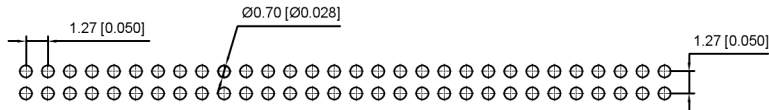
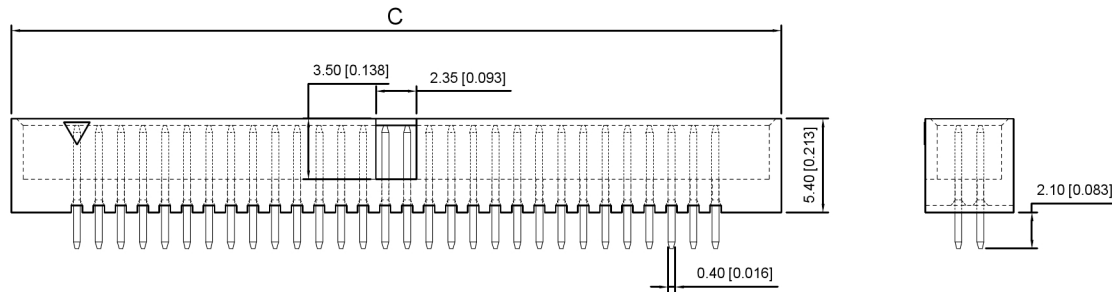
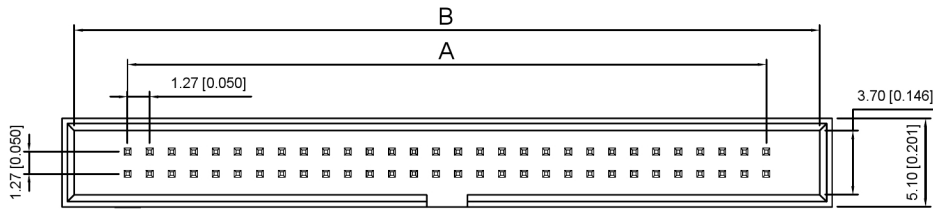

X1270 W V -2xXX A -6T V01
① ② ③ ④ ⑤ ⑥ ⑦

1. Series No
2. Category:W-WAFER
3. Welding Board Angle:V-Stright Angle 180°
4. Row No-Pin No:2xXX-2x05P~2x30P
5. A:No gap
6. Material:6T:Nylon-6T UL94V-0
7. Plating Category: V01-All Gold Flash

NUMBER OF POSITIONS	DIMENSION		
	A	B	C
10	5.08	11.25	12.65
14	7.62	13.79	15.19
16	8.89	15.06	16.46
20	11.43	17.60	19.00
26	15.24	21.41	22.81
30	17.78	23.95	25.35
34	20.32	26.49	27.89
40	24.13	30.30	31.70
50	30.48	36.65	38.05
60	36.83	43.00	44.40

Recommended PCB Layout

X1270WV-2xXXA-6TV01	Nylon-6T UL 94V-0	Copper Alloy	Gold Flash	X1270H
PART NO	Material	Material(Pin And Solder Tabs)	Finish(Pin And Solder Tabs)	Suitable XKB Terminal

广东星坤科技股份有限公司
文件工程章

ANGLAR	±5°
L ≤ 4	±0.2
4 < L ≤ 16	±0.3
16 < L ≤ 63	±0.4
L > 63	±0.5
UNSPECIFIED TOLERANCES	



XKB INDUSTRIAL PRECISION CO., LIMITED

DSND	SCALE: N/A	MODEL TYPE: 1.27mm BTB Style Connectors
DWN	VIEW:	PART NO.:
CHKD	UNIT: mm/in	DWG NO.:
APPD	SIZE: A4	X1270WV-2xXXA-6TV01
		WEIGHT
		SHEET
		REVISION
		1/1
		A0

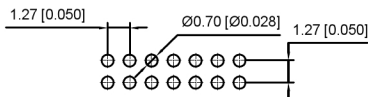
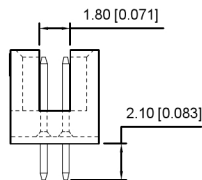
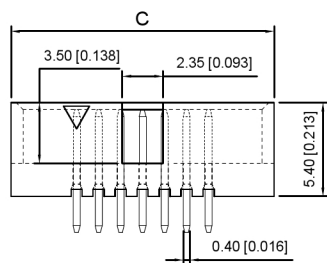
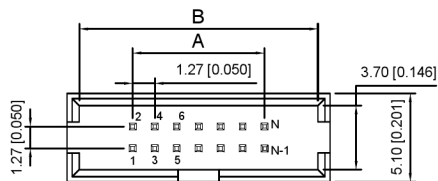

Recommended PCB Layout

Specifications:

规格:

Voltage rating:250V AC/DC

额定电压: 250V AC/DC

Current rating:1A AC/DC

额定电流: 1A AC/DC

Withstanding voltage:500V AC/minute

耐受电压: 500V AC/分钟

Temperature range:-40℃-+105℃

温度范围: -40℃-+105℃

Insulation resistance:≥1000MΩ

绝缘电阻: ≥1000MΩ

Contact resistance:≤20mΩ

接触电阻: ≤20mΩ

X1270 W V -2xXX B -6T V01

① ②③ ④ ⑤ ⑥ ⑦

- 1. Series No
- 2. Category:W-WAFER
- 3. Welding Board Angle:V-Stright Angle 180°
- 4. Row No-Pin No:2xXX-2x05P~2x30P
- 5. B:Contains gaps
- 6. Material:6T:Nylon-6T UL94V-0
- 7. Plating Category: V01-All Gold Flash

NUMBER OF POSITIONS	DIMENSION		
	A	B	C
10	5.08	11.25	12.65
14	7.62	13.79	15.19
16	8.89	15.06	16.46
20	11.43	17.60	19.00
26	15.24	21.41	22.81
30	17.78	23.95	25.35
34	20.32	26.49	27.89
40	24.13	30.30	31.70
50	30.48	36.65	38.05
60	36.83	43.00	44.40

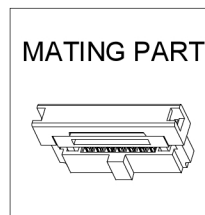

X1270WV-2xXXB-6TV01	Nylon-6T UL 94V-0	Brass	Gold Flash	X1270H
PART NO	Material	Material(Pin And Solder Tabs)	Finish(Pin And Solder Tabs)	Suitable XKB Terminal

广东星坤科技股份有限公司

文件工程章

REVISIONS	DATE	REVISED	APPROVED	UNSPECIFIED TOLERANCES

DSND	SCALE: N/A	MODEL TYPE: 1.27mm BTB Style Connectors
DWN	VIEW:	PART NO.:
CHKD	UNIT: mm/in	DWG NO.:
APPD	SIZE: A4	X1270WV-2xXXB-6TV01
XKB INDUSTRIAL PRECISION CO., LIMITED		WEIGHT
		SHEET
		REVISION
		1/1
		A0

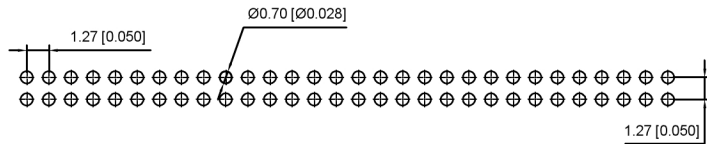
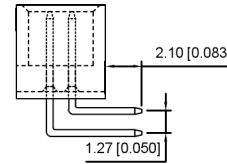
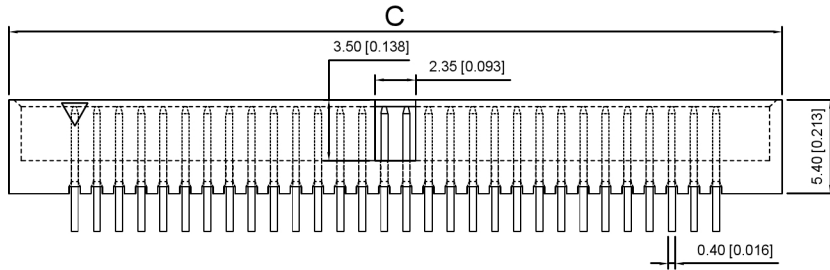
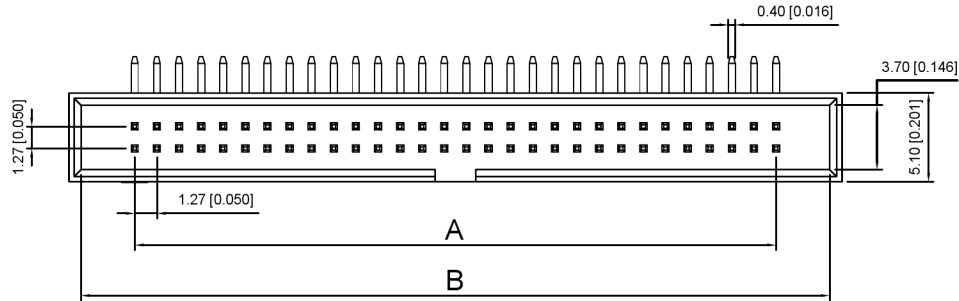

Specifications:

规格:
Voltage rating:250V AC/Min
 额定电压: 250V AC/Min
Current rating:1A AC/DC
 额定电流: 1A AC/DC
Withstanding voltage:500V AC/minute
 耐受电压: 500V AC/分钟
Temperature range:-40℃-+105℃
 温度范围: -40℃-+105℃
Insulation resistance:≥1000MΩ
 绝缘电阻: ≥1000MΩ
Contact resistance:≤20mΩ
 接触电阻: ≤20mΩ

X1270 W R -2xXX A -LP V01
 ① ② ③ ④ ⑤ ⑥ ⑦

1. Series No
2. Category:W-WAFER
3. Wedding Board Angle:R-Right 90°
4. Row No-Pin No:2xXX-2x05P~2x30P
5. A:No gap
6. Material:LP:LCP UL94V-0
7. Plating Category: V01-All Gold Flash

PIN	A	B	C
10	5.08	11.25	12.65
14	7.62	13.79	15.19
16	8.89	15.06	16.46
20	11.43	17.60	19.00
26	15.24	21.41	22.81
30	17.78	23.95	25.35
34	20.32	26.49	27.89
40	24.13	30.30	31.70
50	30.48	36.65	38.05
60	36.83	43.00	44.40

Recommended PCB Layout

X1270WR-2xXXA-LPV01	LCP UL 94V-0	Brass	Gold Flash	X1270H
PART NO	Material	Material(Pin And Solder Tabs)	Finish(Pin And Solder Tabs)	Suitable XKB Terminal

广东星坤科技股份有限公司
 日期
 文件工程章

REVISIONS	DATE	REVISED	APPROVED	UNSPECIFIED TOLERANCES
ANGLAR				±5°
L ≤ 4				±0.2
4 < L ≤ 16				±0.3
16 < L ≤ 63				±0.4
L > 63				±0.5



DSND	SCALE: N/A	MODEL TYPE: 1.27mm BTB Style Connectors
DWN	VIEW:	PART NO.:
CHKD	UNIT: mm/in	DWG NO.:
APPD	SIZE: A4	X1270WR-2xXXA-LPV01
XKB INDUSTRIAL PRECISION CO., LIMITED		WEIGHT
		SHEET
		REVISION
		1/1
		A0

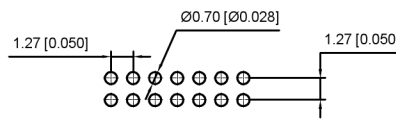
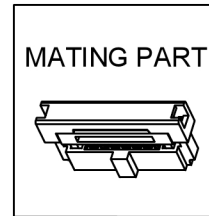
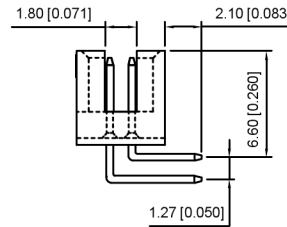
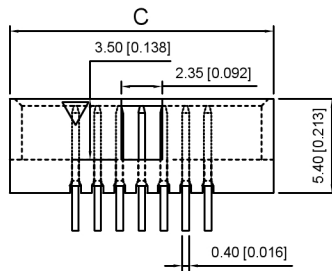
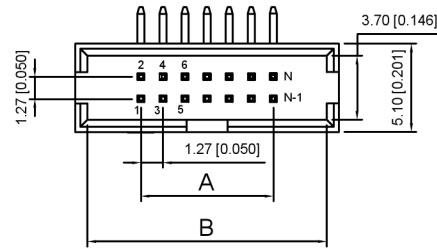

Recommended PCB Layout

Specifications:

规格:

Voltage rating:250V AC/Min

额定电压: 250V AC/Min

Current rating:1A AC/DC

额定电流: 1A AC/DC

Withstanding voltage:500V AC/minute

耐受电压: 500V AC/分钟

Temperature range:-40℃~+105℃

温度范围: -40℃~+105℃

Insulation resistance:≥1000MΩ

绝缘电阻: ≥1000MΩ

Contact resistance:≤20mΩ

接触电阻: ≤20mΩ

X1270 W R -2xXX B -6T V01

① ② ③ ④ ⑤ ⑥ ⑦

1. Series No
2. Category:W-WAFER
3. Wedding Board Angle:R-Right 90°
4. Row No-Pin No:2xXX-2x05P~2x30P
5. B:Contains gaps
6. Material:6T:Nylon-6T UL94V-0
7. Plating Category: V01-All Gold Flash

PIN	A	B	C
10	5.08	11.25	12.65
14	7.62	13.79	15.19
16	8.89	15.06	16.46
20	11.43	17.60	19.00
26	15.24	21.41	22.81
30	17.78	23.95	25.35
34	20.32	26.49	27.89
40	24.13	30.30	31.70
50	30.48	36.65	38.05
60	36.83	43.00	44.40

X1270WR-2xXXB-6TV01	Nylon-6T UL 94V-0	Brass	Gold Flash	X1270H
PART NO	Material	Material(Pin And Solder Tabs)	Finish(Pin And Solder Tabs)	Suitable XKB Terminal

广东星坤科技股份有限公司

生 日期

文件工程章

MARK	DESCRIPTION	DATE	REVISED	APPROVED	UNSPECIFIED TOLERANCES
ΔX					ANGULAR ±5°
ΔX					L ≤ 4 ±0.2
ΔX					4 < L ≤ 16 ±0.3
ΔX					16 < L ≤ 63 ±0.4
MARK					L > 63 ±0.5



XKB INDUSTRIAL PRECISION CO., LIMITED

DSND	SCALE: N/A	MODEL TYPE: 1.27mm BTB Style Connectors
DWN	VIEW:	PART NO.:
CHKD	UNIT: mm/in	DWG NO.:
APPD	SIZE: A4	X1270WR-2xXXB-6TV01
	WEIGHT	SHEET
		1/1
	REVISION	A0

Specifications:

规格:
Voltage rating:250V AC/DC
 额定电压: 250V AC/DC
Current rating:1A AC/DC
 额定电流: 1A AC/DC
Withstanding voltage:500V AC/minute
 耐受电压: 500V AC/分钟
Temperature range:-40 °C~+105 °C
 温度范围: -40°C~+105°C
Insulation resistance:≥1000MΩ
 绝缘电阻: ≥1000MΩ
Contact resistance:≤20mΩ
 接触电阻: ≤20mΩ

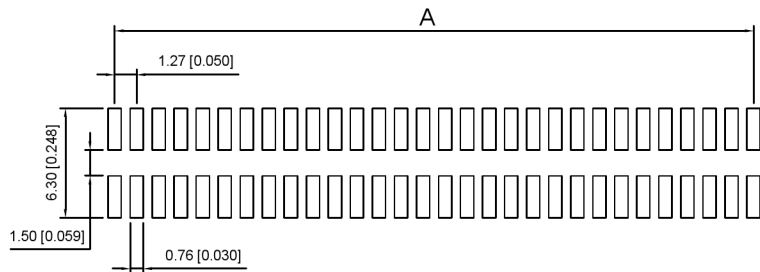
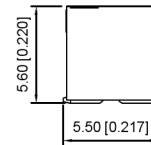
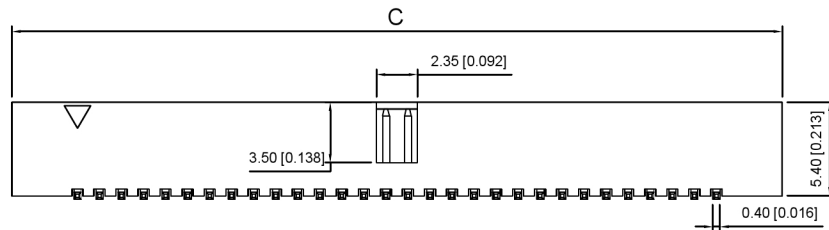
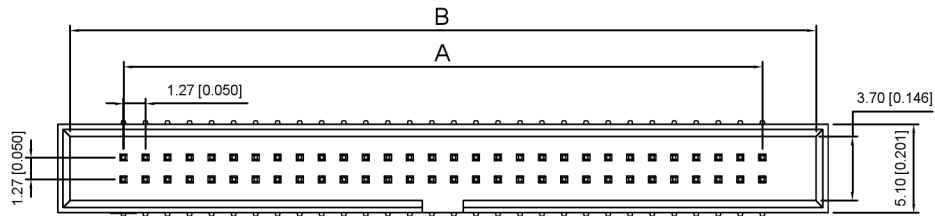

X1270 W V S -2xXX A -LP V01
 ① ② ③ ④ ⑤ ⑥ ⑦ ⑧

1. Series No
2. Category:W-WAFER
3. Welding Board Angle:V-Stright Angle 180°
4. Welding Way:S-SMT
5. Row No-Pin No:2xXX-2x05P~2x30P
6. A:No gap
7. Material:LP:LCP UL94V-0
8. Plating Category: V01-All Gold Flash

NUMBER OF POSITIONS	DIMENSION		
	A	B	C
10	5.08	11.25	12.65
14	7.62	13.79	15.19
16	8.89	15.06	16.46
20	11.43	17.60	19.00
26	15.24	21.41	22.81
30	17.78	23.95	25.35
34	20.32	26.49	27.89
40	24.13	30.30	31.70
50	30.48	36.65	38.05
60	36.83	43.00	44.40

X1270WVS-2xXXA-LPV01	LCP UL 94V-0	Brass	Gold Flash	X1270H
PART NO	Material	Material(Pin And Solder Tabs)	Finish(Pin And Solder Tabs)	Suitable XKB Terminal

广东星坤科技股份有限公司

ΔX	日期
ΔX	日期
ΔX	日期
MARK	日期

REVISIONS

NO.	DESCRIPTION	DATE	REVISED	APPROVED

ANGULAR	±5°
L ≤ 4	±0.2
4 < L ≤ 16	±0.3
16 < L ≤ 63	±0.4
L > 63	±0.5

UNSPECIFIED TOLERANCES



XKB INDUSTRIAL PRECISION CO.,LIMITED

DSND	SCALE: N/A	MODEL TYPE: 1.27mm BTB Style Connectors
DWN	VIEW:	PART NO.:
CHKD	UNIT: mm/in	DWG NO.:
APPD	SIZE: A4	X1270WVS-2xXXA-LPV01
		WEIGHT
		SHEET
		1/1
		REVISION
		A0

文件工程章

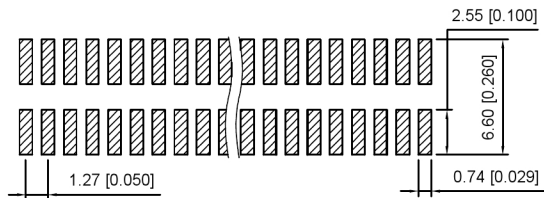
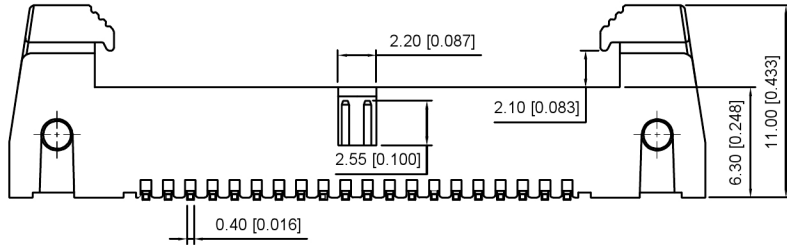
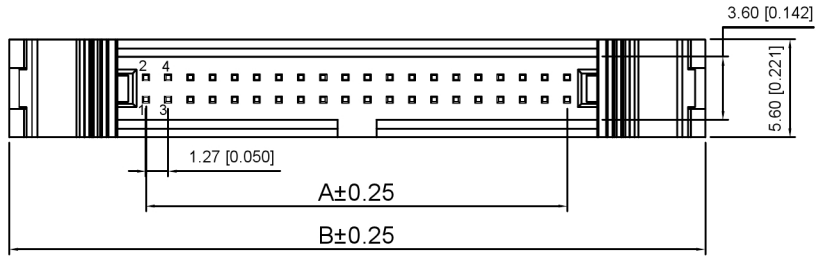

P.C.B LAYOUT

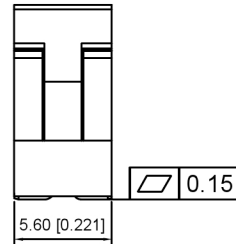

Specifications:

规格:

Voltage rating:250V AC/DC

额定电压: 250V AC/DC

Current rating:1A AC/DC

额定电流: 1A AC/DC

Withstanding voltage:500V AC/minute

耐受电压: 500V AC/分钟

Temperature range:-40℃-+105℃

温度范围: -40℃-+105℃

Insulation resistance:≥1000MΩ

绝缘电阻: ≥1000MΩ

Contact resistance:≤20mΩ

接触电阻: ≤20mΩ

X1270 W V S -2xXX C -PT V01

① ② ③ ④ ⑤ ⑥ ⑦ ⑧

1. Series No
2. Category:W-WAFER
3. Welding Board Angle:V-Stright Angle 180°
4. Welding Way:S-SMT
5. Row No-Pin No:2xXX-2x03P~2x32P
6. C:With Horns
7. Material:PT:PBT UL94V-0
8. Plating Category: V01-All Gold Flash

NUMBER OF POSITIONS	DIMENSION	
	A	B
06	2.54	18.31
08	3.81	19.58
10	5.08	20.85
12	6.35	22.12
14	7.62	23.39
16	8.89	24.66
18	10.16	25.93
20	11.42	27.20
24	13.97	29.74

26	15.24	31.01
30	17.78	33.55
34	20.32	36.09
40	24.13	39.90
50	30.48	46.25
60	36.83	52.60
64	39.37	55.14

X1270WVS-2xXXC-PTV01	PBT UL 94V-0	Brass	Gold Flash	X1270H
PART NO	Material	Material(Pin And Solder Tabs)	Finish(Pin And Solder Tabs)	Suitable XKB Terminal

广东星坤科技股份有限公司

4X 佳 日期

4X 教

MARK 文件工程章

REVISIONS	DATE	REVISED	APPROVED	UNSPECIFIED TOLERANCES
				ANGLAR ±5°
				L ≤ 4 ±0.2
				4 < L ≤ 16 ±0.3
				16 < L ≤ 63 ±0.4
				L > 63 ±0.5



DSND	SCALE: N/A
DWN	VIEW:
CHKD	UNIT: mm/in
APPD	SIZE: A4

MODEL TYPE: 1.27mm BTB Style Connectors		
PART NO.:		
DWG NO.:		
X1270WVS-2xXXC-PTV01		
WEIGHT	SHEET	REVISION
	1/1	A0

XKB INDUSTRIAL PRECISION CO.,LIMITED

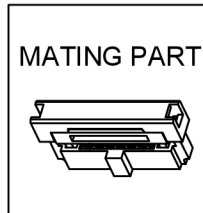
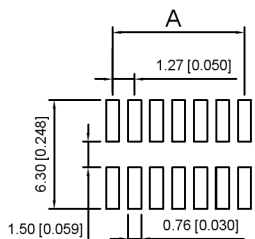
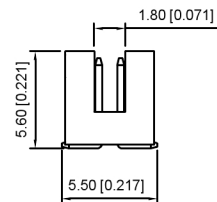
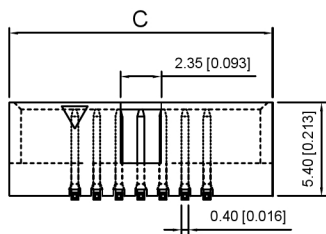
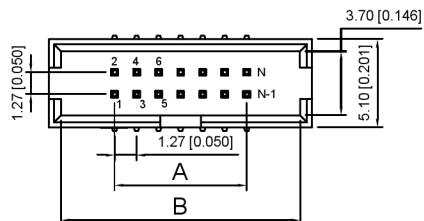

Specifications:

规格:

Voltage rating:250V AC/DC

额定电压: 250V AC/DC

Current rating:1A AC/DC

额定电流: 1A AC/DC

Withstanding voltage:500V AC/minute

耐受电压: 500V AC/分钟

Temperature range:-40 °C-+105 °C

温度范围: -40°C-+105°C

Insulation resistance:≥1000MΩ

绝缘电阻: ≥1000MΩ

Contact resistance:≤20mΩ

接触电阻: ≤20mΩ

X1270 W V S -2xXX B -6T V01

① ② ③ ④ ⑤ ⑥ ⑦ ⑧

1. Series No
2. Category:W-WAFER
3. Welding Board Angle:V-Stright Angle 180°
4. Welding Way:S-SMT
5. Row No-Pin No:2xXX-2x05P~2x30P
6. B:Contains gaps
7. Material:6T:Nylon-6T UL94V-0
8. Plating Category: V01-All Gold Flash

NUMBER OF POSITIONS	DIMENSION		
	A	B	C
10	5.08	11.25	12.65
14	7.62	13.79	15.19
16	8.89	15.06	16.46
20	11.43	17.60	19.00
26	15.24	21.41	22.81
30	17.78	23.95	25.35
34	20.32	26.49	27.89
40	24.13	30.30	31.70
50	30.48	36.65	38.05
60	36.83	43.00	44.40

X1270WVS-2xXXB-6TV01	Nylon-6T UL 94V-0	Brass	Gold Flash	X1270H
PART NO	Material	Material(Pin And Solder Tabs)	Finish(Pin And Solder Tabs)	Suitable XKB Terminal

广东星坤科技股份有限公司

DATE: 日期

REVISIONS: 文件工程章

www.helloxkb.com www.helloxkb.cn www.xk-dg.cn

NO.	REVISIONS	DATE	REVISED	APPROVED	DESCRIPTION

XKLB

XKB INDUSTRIAL PRECISION CO., LIMITED

DSND	SCALE: N/A	MODEL TYPE: 1.27mm BTB Style Connectors
DWN	VIEW: ①	PART NO.:
CHKD	UNIT: mm/in	DWG NO.: X1270WVS-2xXXB-6TV01
APPD	SIZE: A4	WEIGHT SHEET REVISION
		1/1 A0

ANGULAR	±5°
L ≤ 4	±0.2
4 < L ≤ 16	±0.3
16 < L ≤ 63	±0.4
L > 63	±0.5
UNSPECIFIED TOLERANCES	

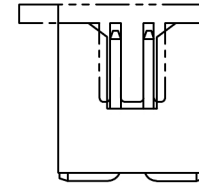
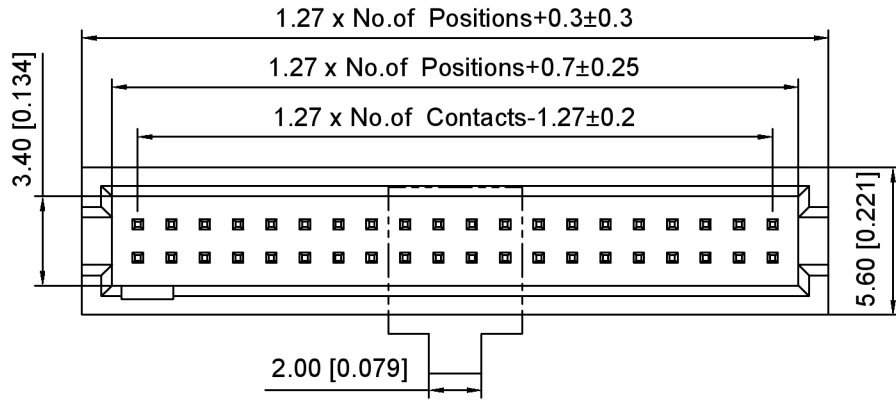

No positioning column

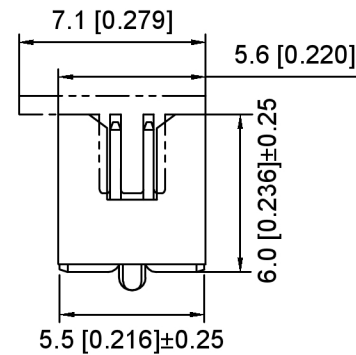
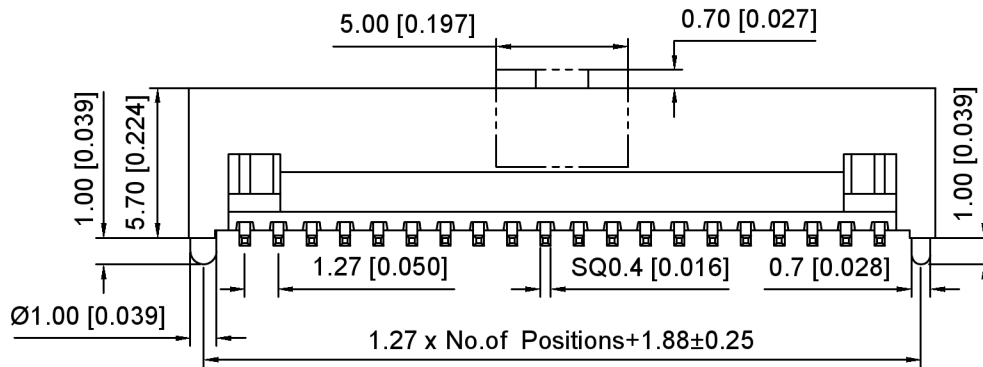

With positioning column

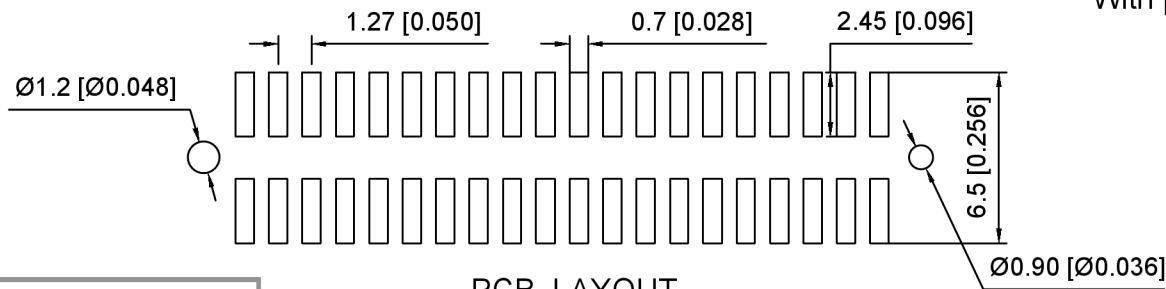

PCB LAYOUT

Specifications:

规格:

- Voltage rating: 250V AC/DC
- 额定电压: 250V AC/DC
- Current rating: 1A AC/DC
- 额定电流: 1A AC/DC
- Withstanding voltage: 300V AC/minute
- 耐受电压: 300V AC/分钟
- Temperature range: -40°C to +105°C
- 温度范围: -40°C to +105°C
- Insulation resistance: 500MΩ min
- 绝缘电阻: 500MΩ Min
- Contact resistance: ≤20mΩ
- 接触电阻: ≤20mΩ

X1270 W V S - 2xXX B X - 6T V01
 ① ② ③ ④ ⑤ ⑥ ⑦ ⑧ ⑨

1. Series No
2. Category: W-Wafer
3. Welding Board Angle: V-Stright 180°
4. Welding Way: S-SMT
5. Row No. Pin No.: XX-02 Pin-N Pin
6. Category: Both sides have a window
7. Type: X-S: With positioning column ;
X-N: No positioning column
8. Material: 6T-PA6T UL94V-0
9. Plating: V01-Gold Flash
SN- Tin Plated

X1270WVS-2xXXBX-6TV01	PA6T	Brass	X1270H
PART NO	Material	Material(Pin)	Suitable XK B Housing

DSND	SCALE: N/A	MODEL TYPE: 1.27mm Crimp Style Connector
DWN	VIEW:	PART NO.: X1270WVS-2xXXBX-6TV01
CHKD	UNIT: mm/in	DWG NO.: X-X1270WVS-2xXXBX-6TV01
APPD	SIZE: A4	



XKB INDUSTRIAL PRECISION CO., LIMITED

WEIGHT	SHEET	REVISION
	1/1	A0

广东星坤科技股份有限公司

DATE	日期
MARK	DESCRIPTION

文件工程章

REVISIONS	UNSPECIFIED TOLERANCES
www.helloxkb.com www.helloxkb.cn www.xk-dg.cn	

Specifications:

规格:

Voltage rating:250V AC/DC

额定电压: 250V AC/DC

Current rating:1A AC/DC

额定电流: 1A AC/DC

Withstanding voltage:500V AC/minute

耐受电压: 500V AC/分钟

Temperature range:-40℃~+105℃

温度范围: -40℃~+105℃

Insulation resistance:≥100MΩ

绝缘电阻: ≥100MΩ

Contact resistance:≤20mΩ

接触电阻: ≤20mΩ

X1270 H 2 -2xXX -PT V01

① ② ③ ④ ⑤ ⑥

1. Series No

2. Category:H-HSG

3.2:With hook

4. Row No-Pin No:2xXX-2x03P~2x40P

5. Material:PT:PBT UL94V-0

6. Plating Category: V01-All Gold Flash

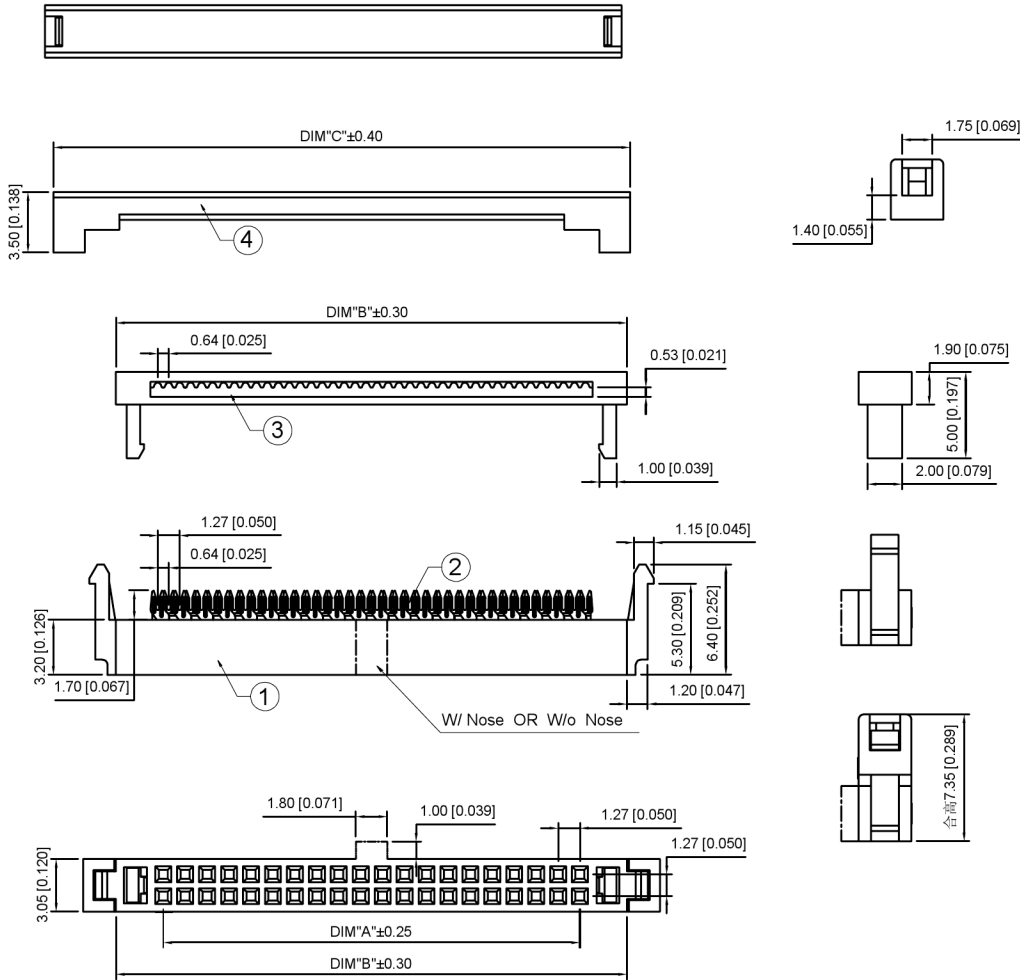

XHB Connectivity

NUMBER OF POSITIONS	DIMENSION		
	A	B	C
06	2.54	8.00	11.80
08	3.81	9.27	13.07
10	5.08	10.54	14.34
12	6.35	11.81	15.61
14	7.62	13.08	16.88
16	8.89	14.35	18.15
20	11.43	16.89	20.69
24	13.97	19.43	23.23
26	15.24	20.70	24.50
30	17.78	23.24	27.04
32	19.05	24.51	28.31
34	20.32	25.78	29.58

36	21.59	27.05	30.85
40	24.13	29.59	33.39
44	26.67	32.13	35.93
50	30.48	35.94	39.74
60	36.83	42.29	46.09
64	39.37	44.83	48.63
66	40.64	46.10	49.90
68	41.91	47.37	51.17
70	43.18	48.64	52.44
74	45.72	51.18	54.98
76	46.99	52.45	56.25
80	49.53	54.99	58.79

X1270H2-2xXX-PTV01	PBT UL 94V-0	Phosphor Bronze	Gold Flash	X1270W
PART NO	Material	Material(Pin And Solder Tabs)	Finish(Pin And Solder Tabs)	Suitable XKB Terminal

广东星坤科技股份有限公司
 日期
 文件工程章

REVISIONS	DATE	REVISED	APPROVED	UNSPECIFIED TOLERANCES
				ANGLAR ±5°
				L ≤ 4 ±0.2
				4 < L ≤ 16 ±0.3
				16 < L ≤ 63 ±0.4
				L > 63 ±0.5



DSND	SCALE: N/A
DWN	VIEW:
CHKD	UNIT: mm/in
APPD	SIZE: A4

MODEL TYPE: 1.27mm BTB Style Connectors		
PART NO.:		
DWG NO.:		
X1270H2-2xXX-PTV01		
WEIGHT	SHEET	REVISION
	1/1	A0

XKB INDUSTRIAL PRECISION CO., LIMITED

Specifications:

规格:
Voltage rating:250V AC/DC
 额定电压: 250V AC/DC
Current rating:1A AC/DC
 额定电流: 1A AC/DC
Withstanding voltage:500V AC/minute
 耐受电压: 500V AC/分钟
Temperature range:-40℃-+105℃
 温度范围: -40℃-+105℃
Insulation resistance:≥100MΩ Min.
 绝缘电阻: ≥100MΩ
Contact resistance:≤20mΩ
 接触电阻: ≤20mΩ

X1270 H 1 -2xXX -PT V01
 ① ② ③ ④ ⑤ ⑥

- 1. Series No
- 2. Category: H-HSG
- 3.1: Thicken
- 4. Row No-Pin No: 2xXX-2x03P~2x40P
- 5. Material: PT: PBT UL94V-0
- 6. Plating Category: V01-All Gold Flash

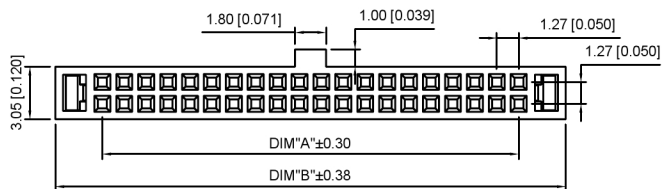
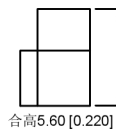
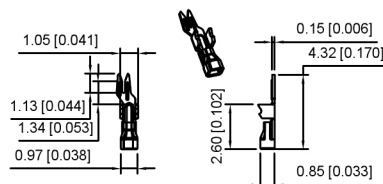
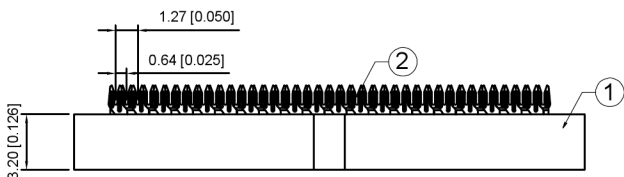
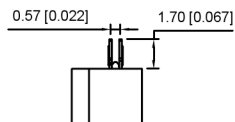
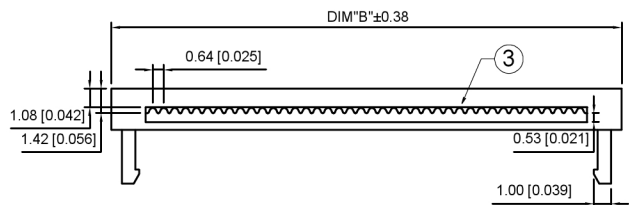
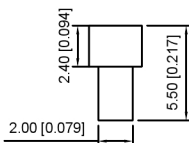
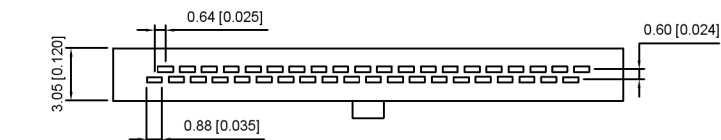

XKB Connectivity

NUMBER OF POSITIONS	DIMENSION	
	A	B
06	2.54	8.00
08	3.81	9.27
10	5.08	10.54
12	6.35	11.81
14	7.62	13.08
16	8.89	14.35
20	11.43	16.89
24	13.97	19.43
26	15.24	20.70
30	17.78	23.24
32	19.05	24.51
34	20.32	25.78

36	21.59	27.05
40	24.13	29.59
44	26.67	32.13
50	30.48	35.94
60	36.83	42.29
64	39.37	44.83
66	40.64	46.10
68	41.91	47.37
70	43.18	48.64
74	45.72	51.18
76	46.99	52.45
80	49.53	54.99

PART NO	Material	Material (Pin And Solder Tabs)	Finish (Pin And Solder Tabs)	Suitable XKB Terminal
X1270H1-2xXX-PTV01	PBT UL 94V-0	Phosphor Bronze	Gold Flash	X1270W

广东星坤科技股份有限公司

生 日期

文件工程章

REVISIONS	DATE	REVISED	APPROVED	UNSPECIFIED TOLERANCES

XKLB

XKB INDUSTRIAL PRECISION CO., LIMITED

MODEL TYPE:	SCALE:	VIEW:	UNIT:	SIZE:
1.27mm BTB Style Connectors	N/A	①	mm/in	A4
PART NO.:				
DWG NO.:				
X1270H1-2xXX-PTV01				
WEIGHT	SHEET	REVISION		
	1/1	A0		

Specifications:

规格:

Voltage rating:250V AC/DC

额定电压: 250V AC/DC

Current rating:1A AC/DC

额定电流: 1A AC/DC

Withstanding voltage:500V AC/minute

耐受电压: 500V AC/分钟

Temperature range:-40℃~+105℃

温度范围: -40℃~+105℃

Insulation resistance:≥100MΩ

绝缘电阻: ≥100MΩ

Contact resistance:≤20mΩ

接触电阻: ≤20mΩ

X1270 H -2xXX -PT V01

① ② ③ ④ ⑤

1. Series No

2. Category:H-HSG

3. Row No-Pin No:2xXX-2x03P~2x40P

4. Material:PT:PBT UL94V-0

5. Plating Category: V01-All Gold Flash

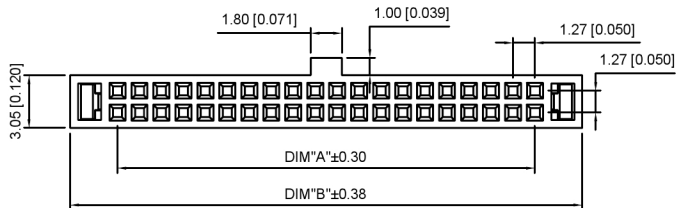
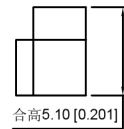
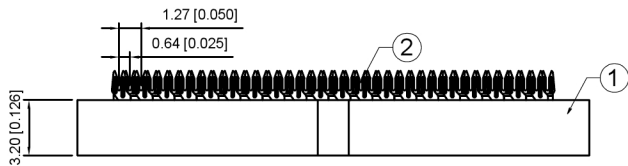
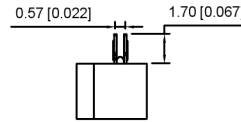
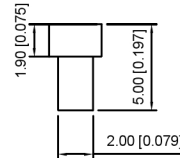
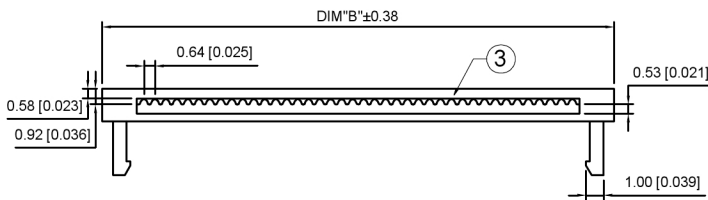
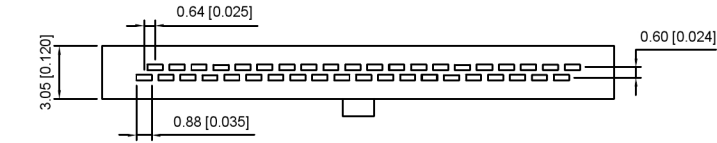

XKB Connectivity

NUMBER OF POSITIONS	DIMENSION	
	A	B
06	2.54	8.00
08	3.81	9.27
10	5.08	10.54
12	6.35	11.81
14	7.62	13.08
16	8.89	14.35
20	11.43	16.89
24	13.97	19.43
26	15.24	20.70
30	17.78	23.24
32	19.05	24.51
34	20.32	25.78

36	21.59	27.05
40	24.13	29.59
44	26.67	32.13
50	30.48	35.94
60	36.83	42.29
64	39.37	44.83
66	40.64	46.10
68	41.91	47.37
70	43.18	48.64
74	45.72	51.18
76	46.99	52.45
80	49.53	54.99

PART NO	Material	Material(Pin And Solder Tabs)	Finish(Pin And Solder Tabs)	Suitable XKB Terminal
X1270H-2xXX-PTV01	PBT UL 94V-0	Phosphor Bronze	Gold Flash	X1270W

DSND	SCALE: N/A	MODEL TYPE: 1.27mm BTB Style Connectors
DWN	VIEW:	PART NO.:
CHKD	UNIT: mm/in	DWG NO.:
APPD	SIZE: A4	X1270H-2xXX-PTV01
XKB INDUSTRIAL PRECISION CO., LIMITED		WEIGHT
		SHEET
		REVISION
		1/1
		A0

广东星坤科技股份有限公司

生 日期

文件工程章

REVISIONS

DATE REVISED APPROVED

UNSPECIFIED TOLERANCES

ANGULAR ±5°
L ≤ 4 ±0.2
4 < L ≤ 16 ±0.3
16 < L ≤ 63 ±0.4
L > 63 ±0.5



www.helloxkb.com www.helloxkb.cn www.xk-dg.cn

Straight Type

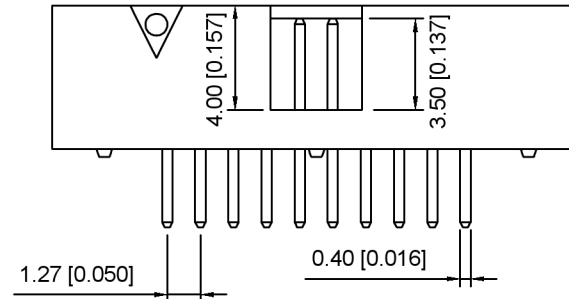
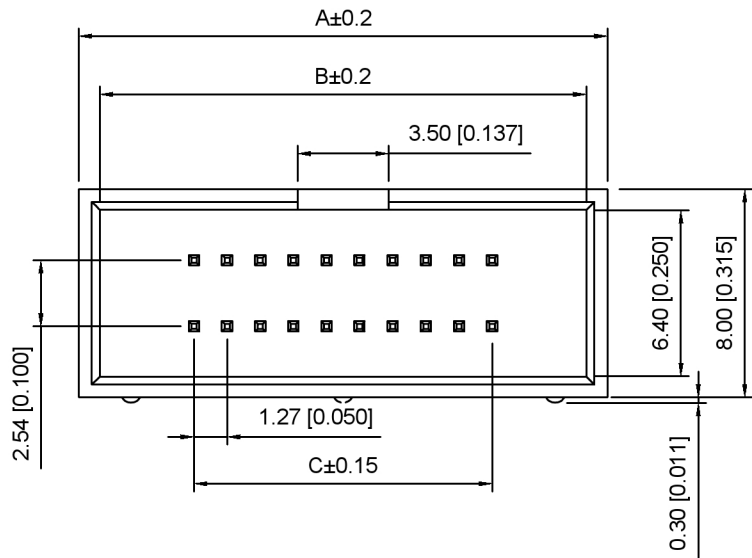

Voltage rating:500V AC/DC

额定电压:500V AC/DC

Current rating:1.0A

额定电流: 1.0A

Insulation resistance:1000MΩ Min

绝缘电阻: 1000MΩ Min

Withstanding voltage:≥500V AC/minute

耐压: ≥500V/分钟

Temperature range:-40 °C~+105 °C

使用温度: -40 °C~+105 °C

X1270 W V -2xXX A2 - 6T V01
① ② ③ ④ ⑤ ⑥ ⑦

- ① Series No.
- ② Category:W-wafer
- ③ Welding Board Angle:V- Straight 180°
- ④ Row No.-Pin No.:2xXX-2x04P~2x40P
- ⑤ A2:1.27x2.54mm No gaps
- ⑥ Material:6T-Nylon PA6T UL94V-0
- ⑦ Planting Category:V01-All Gold Flash

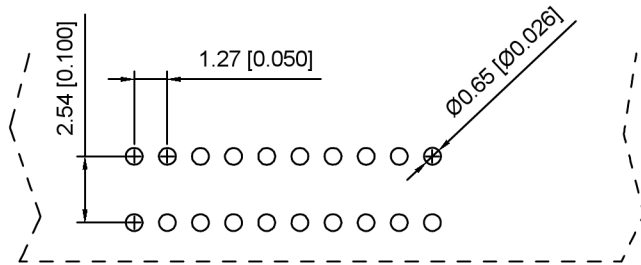

P.C.B Layout

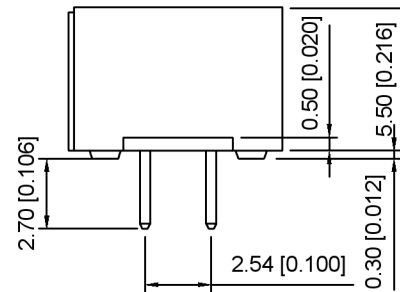

position	A	B	C
2x04	12.64	11.04	3.81
2x05	13.91	12.31	5.08
2x06	15.18	13.58	6.35
2x07	16.45	14.85	7.62
2x08	17.72	16.12	8.89
2x10	20.26	18.66	11.43
2x13	24.07	22.47	15.24
2x15	26.61	25.01	17.78
2x17	29.15	27.55	20.32
2x20	32.96	31.36	24.13
2x22	35.50	33.90	26.67
2x25	39.31	37.71	30.48
2x30	45.66	44.06	36.83
2x33	48.20	46.60	39.37
2x34	50.74	49.14	41.91
2x40	58.36	56.76	49.53

广东星坤科技股份有限公司

ΔX	生效	日期
ΔX		
ΔX		
MARK	文件工程草	DESCRIPTION
	REVISIONS	DATE
	REVISED	APPROVED
	UNSPECIFIED TOLERANCES	

ANGLAR	±5°
L ≤ 4	±0.2
4 < L ≤ 16	±0.3
16 < L ≤ 63	±0.4
L > 63	±0.5



XKB INDUSTRIAL PRECISION CO., LIMITED

DSND	SCALE: N/A	MODEL TYPE: 1.27x2.54mm
DWN	VIEW:	PART NO.: X1270WV-2xXXA2-6TV01
CHKD	UNIT: mm/in	DWG NO.: X-X1270WV-2xXXA2-6TV01
APPD	SIZE: A4	WEIGHT
		SHEET
		REVISION
		1/1
		A0

Right Angle Type

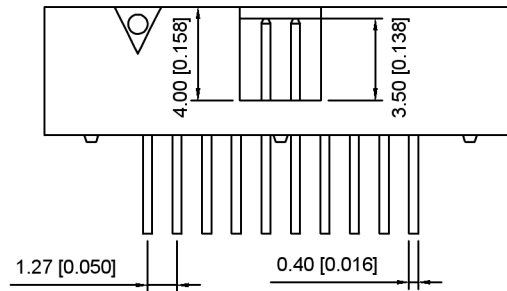
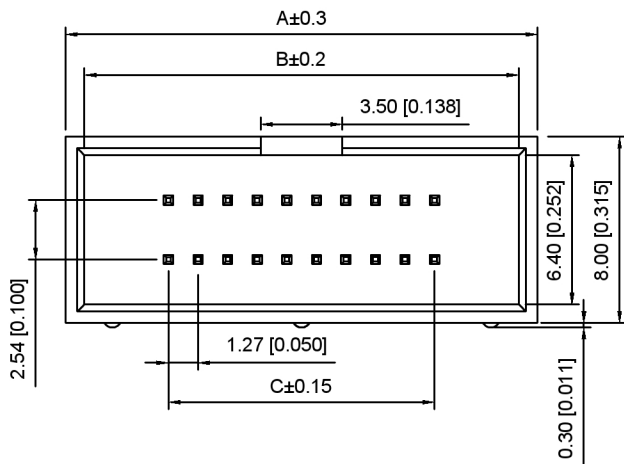

Voltage rating:500V AC/DC
 额定电压:500V AC/DC
 Current rating:1.0A
 额定电流:1.0A
 Insulation resistance:1000MΩ Min
 绝缘电阻:1000MΩ Min
 Withstanding voltage:≥500V AC/minute
 耐压:≥500V AC/分钟
 Temperature range:-40℃~+105℃
 使用温度:-40℃~+105℃

X1270 W R -2xXX A2 - 6T V01
 ① ② ③ ④ ⑤ ⑥ ⑦

- ① Series No.
- ② Category:W-wafer
- ③ Welding Board Angle:R- Straight 90°
- ④ Row No.-Pin No.:2xXX-2x04P~2x40P
- ⑤ A2:1.27x2.54mm No gaps
- ⑥ Material:6T-Nylon PA6T UL94V-0
- ⑦ Planting Category:V01-All Gold Flash

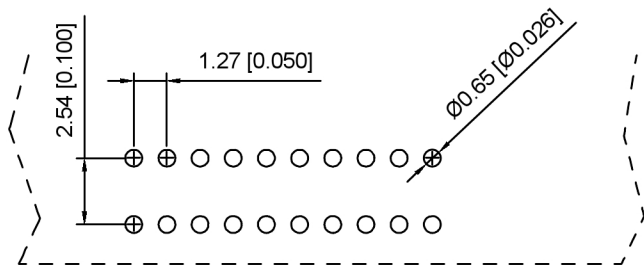

P.C.B Layout

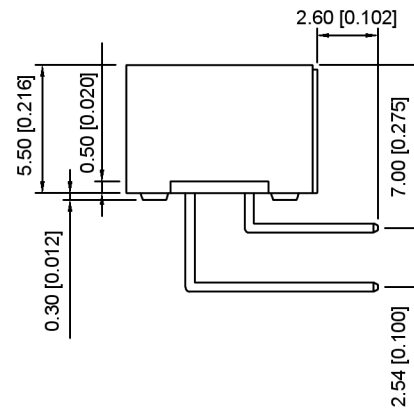

positor	A	B	C
2x04	12.64	11.04	3.81
2x05	13.91	12.31	5.08
2x06	15.18	13.58	6.35
2x07	16.45	14.85	7.62
2x08	17.72	16.12	8.89
2x10	20.26	18.66	11.43
2x13	24.07	22.47	15.24
2x15	26.61	25.01	17.78
2x17	29.15	27.55	20.32
2x20	32.96	31.36	24.13
2x22	35.50	33.90	26.67
2x25	39.31	37.71	30.48
2x30	45.66	44.06	36.83
2x33	48.20	46.60	39.37
2x34	50.74	49.14	41.91
2x40	58.36	56.76	49.53

广东星坤科技股份有限公司

生 日期
 效 日期
 文件工程章

MARK	DESCRIPTION	DATE	REVISED	APPROVED	UNSPECIFIED TOLERANCES
					ANGULAR ±5°
					L ≤ 4 ±0.2
					4 < L ≤ 16 ±0.3
					16 < L ≤ 63 ±0.4
					L > 63 ±0.5



DSND	SCALE: N/A	MODEL TYPE: 1.27x2.54mm
DWN	VIEW:	PART NO.: X1270WR-2xXXA2-6TV01
CHKD	UNIT: mm/in	DWG NO.: X-X1270WR-2xXXA2-6TV01
APPD	SIZE: A4	WEIGHT SHEET REVISION 1/1 A0

XKB INDUSTRIAL PRECISION CO.,LIMITED

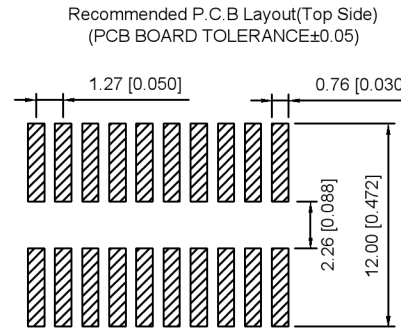
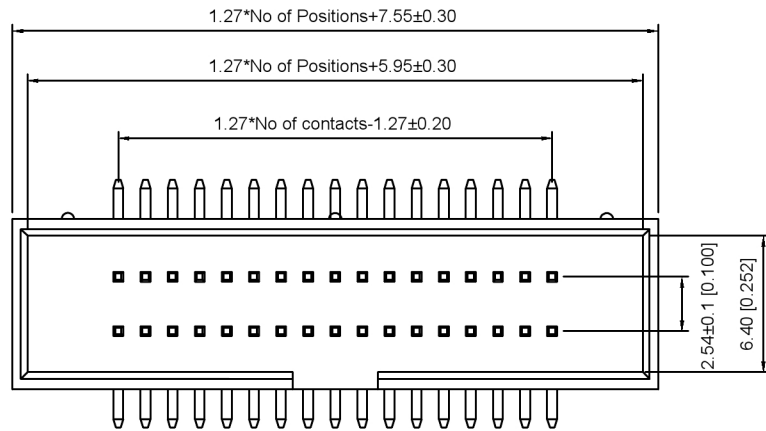

Voltage rating:500V AC/DC

额定电压:500V AC/DC

Current rating:1.0A

额定电流:1.0A

Insulation resistance:1000MΩ Min

绝缘电阻:1000MΩ Min

Withstanding voltage:≥500V AC/minute

耐压:≥500VC/分钟

Temperature range:-40℃-+105℃

使用温度:-40℃-+105℃

X1270 W V S -2xXX A2 -6T XX
 ① ② ③ ④ ⑤ ⑥ ⑦ ⑧

① Series No.

② Category:W-wafer

③ Welding Board Angle:V- Straight 180°

④ Welding Way:S-SMT

⑤ Row No.-Pin No.:2xXX-2x04P~2x40P

⑥ A2:1.27x2.54mm

⑦ Material:6T-Nylon PA6T UL94V-0

⑧ Planting Category:V01-Gold Plating Or Sn-Tin Plating

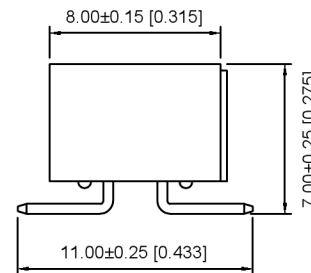
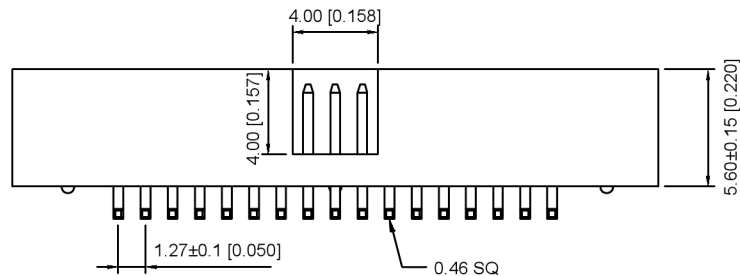

广东星坤科技股份有限公司

ΔX	生效	日期
ΔX		
ΔX		
MARK	DESCRIPTION	DATE

文件工程章

REVISIONS UNSPECIFIED TOLERANCES

www.helloxkb.com www.helloxkb.cn www.xk-dg.cn

ANGLAR	±5°
L ≤ 4	±0.2
4 < L ≤ 16	±0.3
16 < L ≤ 63	±0.4
L > 63	±0.5



DSND	SCALE: N/A	MODEL TYPE: 1.27x2.54mm
DWN	VIEW:	PART NO.: X1270WVS-2xXXA2-6TXX
CHKD	UNIT: mm/in	DWG NO.: X-X1270WVS-2xXXA2-6TXX
APPD	SIZE: A4	WEIGHT SHEET REVISION 1/1 A0

XKB INDUSTRIAL PRECISION CO.,LIMITED

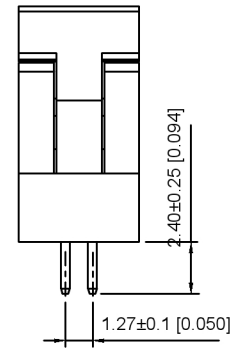
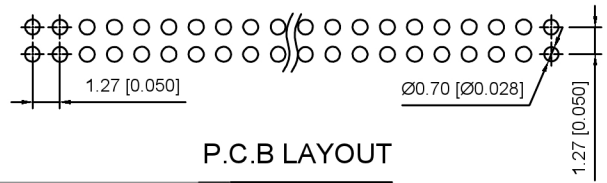
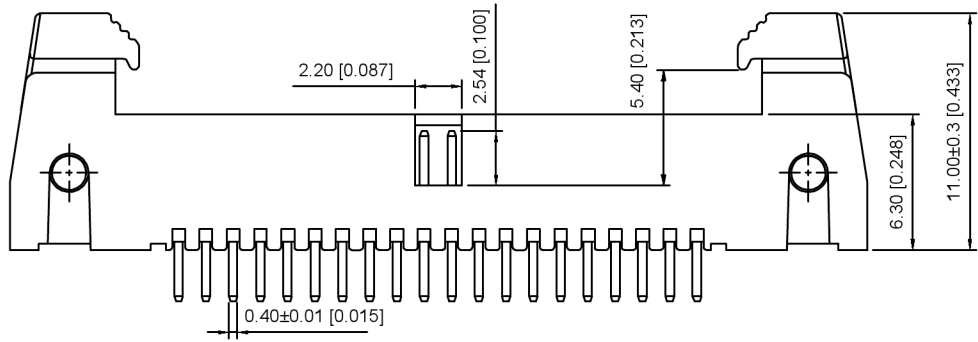
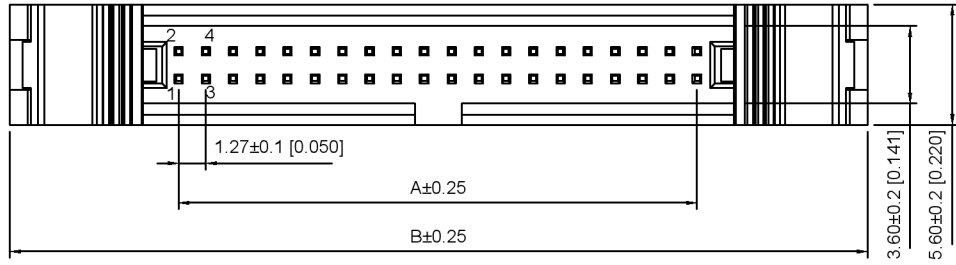

Voltage rating:500V AC/DC
 额定电压:500V AC/DC
 Current rating:1.0A
 额定电流:1.0A
 Insulation resistance:1000MΩ Min
 绝缘电阻:1000MΩ Min
 Withstanding voltage:≥500V AC/minute
 耐压:≥500VC/分钟
 Temperature range:-40℃-+105℃
 使用温度:-40℃-+105℃

X1270 W V -2xXX C - 6T V01
 ① ② ③ ④ ⑤ ⑥ ⑦

- ① Series No.
- ② Category:W-wafer
- ③ Welding Board Angle:V- Straight 180°
- ④ Row No.-Pin No.:2xXX-2x03P~2x32P
- ⑤ C:With Horns
- ⑥ Material:6T-Nylon PA6T UL94V-0
- ⑦ Planting Category:V01-All Gold Flash

NUMBER OF POSITIONS	DIMENSIONS	
	A	B
2x03	2.54	18.31
2x04	3.81	19.58
2x05	5.08	20.85
2x06	6.35	22.12
2x07	7.62	23.39
2x08	8.89	24.66
2x09	10.16	25.93
2x10	11.42	27.20
2x12	13.97	29.74
2x13	15.24	31.01
2x15	17.78	33.55
2x17	20.32	36.09
2x20	24.13	39.90
2x25	30.48	46.25
2x30	36.83	52.60
2x32	39.37	55.14

广东星坤科技股份有限公司

生效 日期

文件工程章

REVISIONS	DATE	REVISED	APPROVED	UNSPECIFIED TOLERANCES

XKB

XKB INDUSTRIAL PRECISION CO., LIMITED

DSND	SCALE: N/A	MODEL TYPE: 1.27mm Crimp Style Connectors
DWN	VIEW:	PART NO.: X1270WV-2xXXC-6TV01
CHKD	UNIT: mm/in	DWG NO.: X-X1270WV-2xXXC-6TV01
APPD	SIZE: A4	WEIGHT SHEET REVISION 1/1 A0

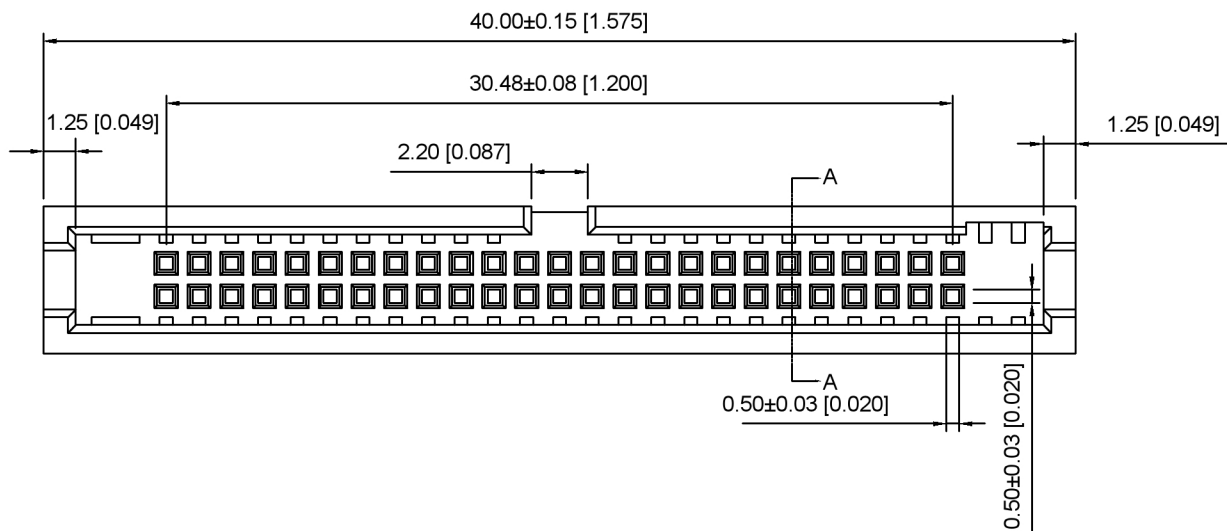

Voltage rating:250V AC/DC

额定电压: 250V AC/DC

Current rating:1.0A

额定电流: 1.0A

Insulation resistance:1000MΩ Min

绝缘电阻: 1000MΩ Min

Withstanding voltage:≥500V AC/minute

耐压: ≥500VC/分钟

Temperature range:-40℃-+250℃

使用温度: -40℃-+250℃

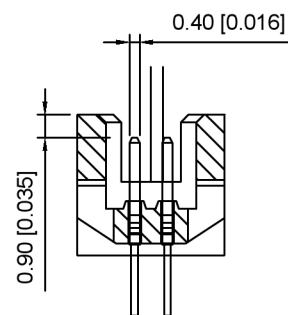

X1270 W V -2xXX B1 - 9T AuSn
 ① ② ③ ④ ⑤ ⑥ ⑦

- ① Series No.
- ② Category:W-wafer
- ③ Welding Board Angle:V- Straight 180°
- ④ Row No.-Pin No.:2xXX-2x03P~2x32P
- ⑤ B1:Type B Contains gaps
- ⑥ Material:PA9T-Nylon PA9T UL94V-0
- ⑦ Planting Category:AuSn-Plating AuSn

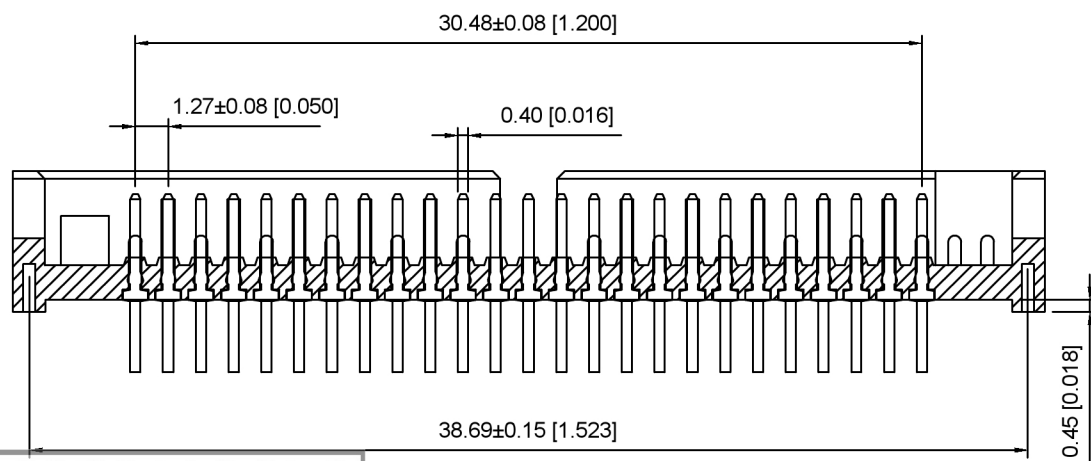

广东星坤科技股份有限公司

生效	日期
文件工程章	DESCRIPTION

REVISIONS	UNSPECIFIED TOLERANCES
DATE	REVISED
APPROVED	ANGLAR ±5°
	L ≤ 4 ±0.2
	4 < L ≤ 16 ±0.3
	16 < L ≤ 63 ±0.4
	L > 63 ±0.5



DSND	SCALE: N/A	MODEL TYPE: 1.27mm B
DWN	VIEW: ④	PART NO.: X1270WV-2xXXB1-9TAuSn
CHKD	UNIT: mm/in	DWG NO.: X-X1270WV-2xXXB1-9TAuSn
APPD	SIZE: A4	WEIGHT SHEET REVISION
		1/1 A0

XKB INDUSTRIAL PRECISION CO.,LIMITED

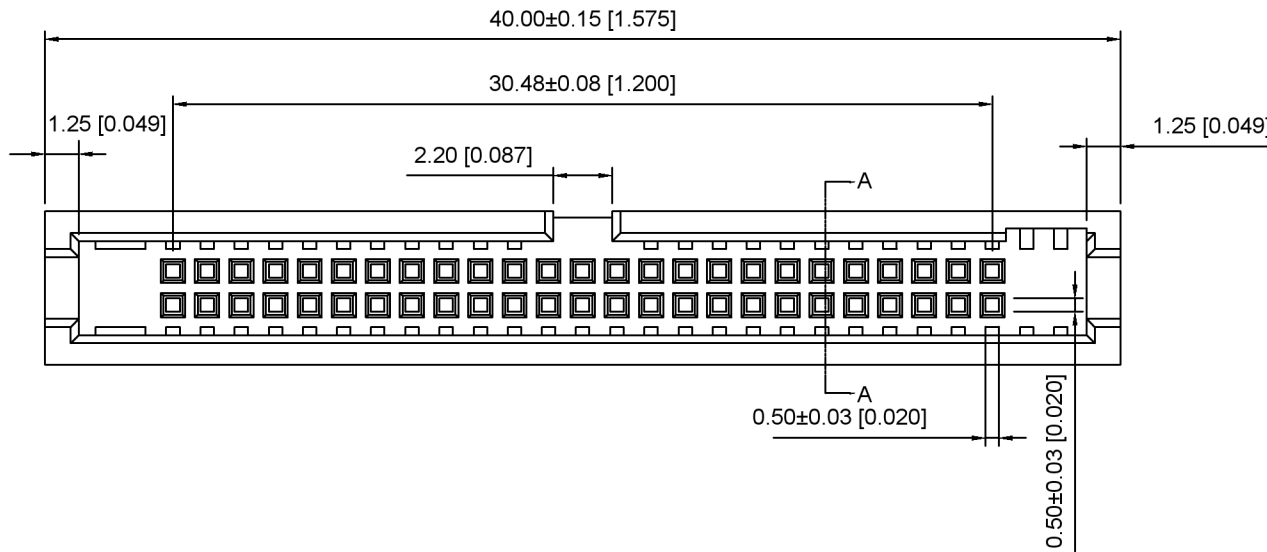

Voltage rating: 250V AC/DC
 额定电压: 250V AC/DC
 Current rating: 1.0A
 额定电流: 1.0A
 Insulation resistance: 1000MΩ Min
 绝缘电阻: 1000MΩ Min
 Withstanding voltage: ≥500V AC/minute
 耐压: ≥500V AC/分钟
 Temperature range: -40°C - +250°C
 使用温度: -40°C - +250°C

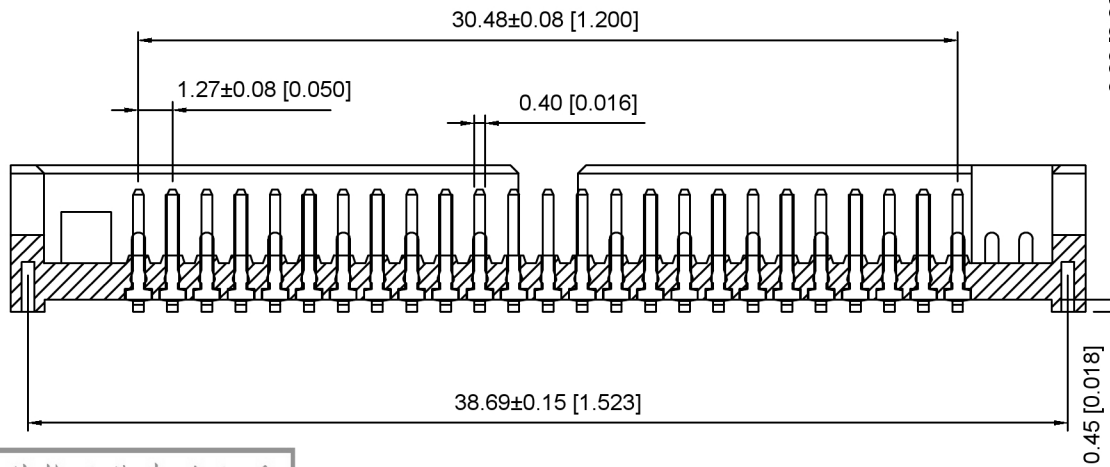
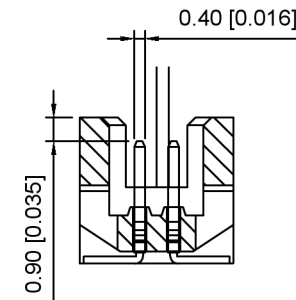

X1270 W V S -2xXX B1 - 9T AuSn
 ① ② ③④ ⑤ ⑥ ⑦ ⑧

- ① Series No.
- ② Category: W-wafer
- ③ Welding Way: S-SMT
- ④ Welding Board Angle: V- Straight 180°
- ⑤ Row No.-Pin No.: 2xXX-2x03P~2x32P
- ⑥ B1: Type B Contains gaps
- ⑦ Material: PA9T-Nylon PA9T UL94V-0
- ⑧ Planting Category: AuSn-Plating AuSn

广东星坤科技股份有限公司

生 日期
 ΔX Δ效
 ΔX MARK

文件工程章

ANGLAR	±5°
L ≤ 4	±0.2
4 < L ≤ 16	±0.3
16 < L ≤ 63	±0.4
L > 63	±0.5



DSND	SCALE: N/A	MODEL TYPE: 1.27mm B
DWN	VIEW:	PART NO.: X1270WWS-2xXXB1-9TAuSn
CHKD	UNIT: mm/in	DWG NO.: X-X1270WWS-2xXXB1-9TAuSn
APPD	SIZE: A4	WEIGHT SHEET REVISION 1/1 A0

KKB INDUSTRIAL PRECISION CO., LIMITED

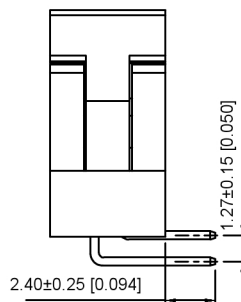
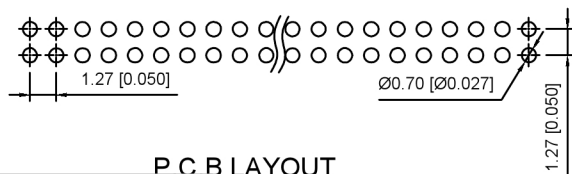
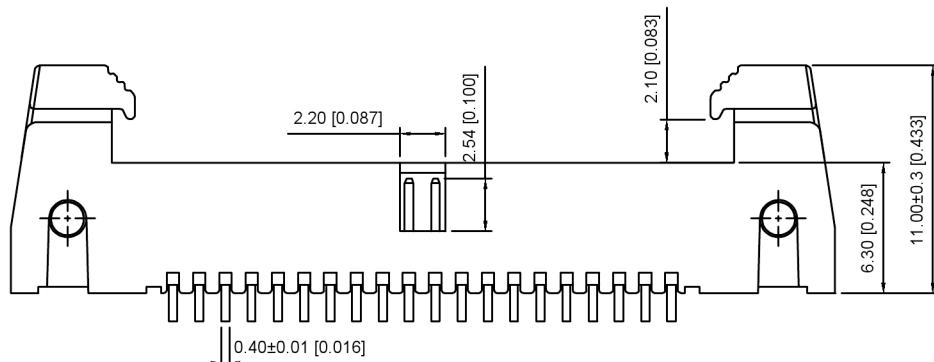
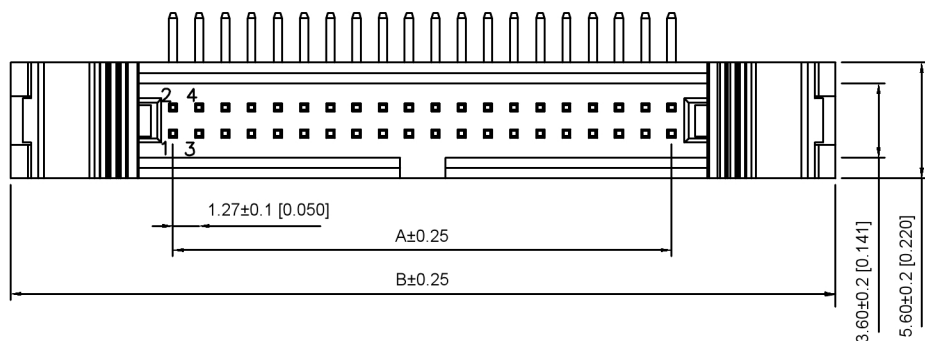

Voltage rating:500V AC/DC
 额定电压 :500V AC/DC
 Current rating:1.0A
 额定电流 : 1.0A
 Insulation resistance:1000MΩ Min
 绝缘电阻 : 1000MΩ Min
 Withstanding voltage:≥500V AC/minute
 耐压 : ≥500VC/分钟
 Temperature range:-40℃-+105℃
 使用温度 : -40℃-+105℃

X1270 W R -2xXX C - 6T V01
 ① ② ③ ④ ⑤ ⑥ ⑦

- ① Series No.
- ② Category:W-wafer
- ③ Welding Board Angle:R- Straight 90°
- ④ Row No.-Pin No.:2xXX-2x03P~2x32P
- ⑤ C:With Horns
- ⑥ Material:6T-Nylon PA6T UL94V-0
- ⑦ Planting Category:V01-All Gold Flash

NUMBER OF POSITIONS	DIMENSIONS	
	A	B
2x03	2.54	18.31
2x04	3.81	19.58
2x05	5.08	20.85
2x06	6.35	22.12
2x07	7.62	23.39
2x08	8.89	24.66
2x09	10.16	25.93
2x10	11.42	27.20
2x12	13.97	29.74
2x13	15.24	31.01
2x15	17.78	33.55
2x17	20.32	36.09
2x20	24.13	39.90
2x25	30.48	46.25
2x30	36.83	52.60
2x32	39.37	55.14

P.C.B LAYOUT

广东星坤科技股份有限公司

生 日期
 文件工程章

DESCRIPTION DATE REVISED APPROVED

REVISIONS

www.helloxkb.com www.helloxkb.cn www.xk-dg.cn

ANGLAR	±5°
L ≤ 4	±0.2
4 < L ≤ 16	±0.3
16 < L ≤ 63	±0.4
L > 63	±0.5

UNSPECIFIED TOLERANCES

XKLB

XKB INDUSTRIAL PRECISION CO.,LIMITED

DSND	SCALE: N/A	MODEL TYPE: 1.27mm Crimp Style Connectors	
DWN	VIEW:	PART NO.: X1270WR-2xXXC-6TV01	
CHKD	UNIT: mm/in	DWG NO.:	
APPD	SIZE: A4	X-X1270WR-2xXXC-6TV01	
	WEIGHT	SHEET	REVISION
		1/1	A0