



# High Speed Infrared Emitting Diodes, 940 nm, GaAlAs, MQW



## DESCRIPTION

VSMB2943SLX01 is an infrared, 940 nm, side looking emitting diode in GaAlAs multi quantum well (MQW) technology with high radiant power and high speed, molded in clear, untinted plastic package (with lens) for surface mounting (SMD).

## APPLICATIONS

- IrDA compatible data transmission
- Miniature light barrier
- Photointerrupters
- Optical switch
- Remote control
- IR touch panels

## FEATURES

- Package type: surface mount
- Package form: side view
- Dimensions (L x W x H in mm): 2.3 x 2.55 x 2.3
- AEC-Q101 qualified
- Peak wavelength:  $\lambda_p = 940$  nm
- High reliability
- High radiant power
- High radiant intensity
- Angle of half intensity:  $\phi = \pm 25^\circ$
- Low forward voltage
- Suitable for high pulse current operation
- Package matches with detector VEMD2023SLX01 and VEMT2023SLX01
- Floor life: 4 weeks, MSL 2a, acc. J-STD-020
- Material categorization: For definitions of compliance please see [www.vishay.com/doc?99912](http://www.vishay.com/doc?99912)



PRODUCT SUMMARY				
COMPONENT	I <sub>e</sub> (mW/sr)	φ (deg)	λ <sub>p</sub> (nm)	t <sub>r</sub> (ns)
VSMB2943SLX01	20	± 25	940	15

### Note

- Test conditions see table “Basic Characteristics“

ORDERING INFORMATION			
ORDERING CODE	PACKAGING	REMARKS	PACKAGE FORM
VSMB2943SLX01	Tape and reel	MOQ: 3000 pcs, 3000 pcs/reel	Side view

### Note

- MOQ: minimum order quantity

ABSOLUTE MAXIMUM RATINGS (T <sub>amb</sub> = 25 °C, unless otherwise specified)				
PARAMETER	TEST CONDITION	SYMBOL	VALUE	UNIT
Reverse voltage		V <sub>R</sub>	5	V
Forward current		I <sub>F</sub>	100	mA
Peak forward current	t <sub>p</sub> /T = 0.5, t <sub>p</sub> = 100 μs	I <sub>FM</sub>	200	mA
Surge forward current	t <sub>p</sub> = 100 μs	I <sub>FSM</sub>	1	A
Power dissipation		P <sub>V</sub>	160	mW
Junction temperature		T <sub>J</sub>	100	°C
Operating temperature range		T <sub>amb</sub>	-40 to +85	°C
Storage temperature range		T <sub>stg</sub>	-40 to +100	°C
Soldering temperature	according figure 9, J-STD-020	T <sub>sd</sub>	260	°C
Thermal resistance junction/ambient	J-STD-051, leads 7 mm, soldered on PCB	R <sub>thJA</sub>	250	K/W

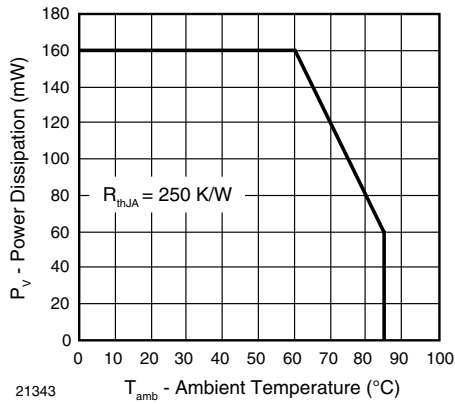

Fig. 1 - Power Dissipation Limit vs. Ambient Temperature

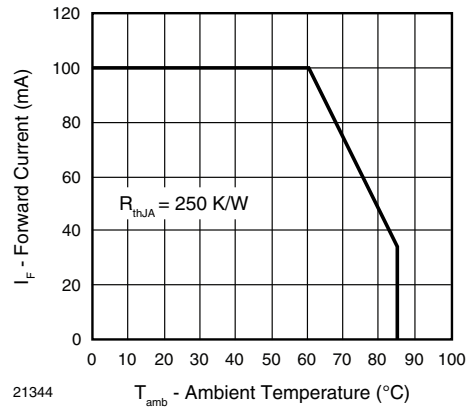

Fig. 2 - Forward Current Limit vs. Ambient Temperature

BASIC CHARACTERISTICS (T <sub>amb</sub> = 25 °C, unless otherwise specified)						
PARAMETER	TEST CONDITION	SYMBOL	MIN.	TYP.	MAX.	UNIT
Forward voltage	I <sub>F</sub> = 100 mA, t <sub>p</sub> = 20 ms	V <sub>F</sub>	1.15	1.35	1.6	V
	I <sub>F</sub> = 1 A, t <sub>p</sub> = 100 μs	V <sub>F</sub>		2.2		V
Temperature coefficient of V <sub>F</sub>	I <sub>F</sub> = 1 mA	TK <sub>V<sub>F</sub></sub>		-1.8		mV/K
	I <sub>F</sub> = 100 mA	TK <sub>V<sub>F</sub></sub>		-1.1		mV/K
Reverse current		I <sub>R</sub>	Not designed for reverse operation			μA
Junction capacitance	V <sub>R</sub> = 0 V, f = 1 MHz, E = 0 mW/cm <sup>2</sup>	C <sub>J</sub>		70		pF
Radiant intensity	I <sub>F</sub> = 100 mA, t <sub>p</sub> = 20 ms	I <sub>e</sub>	10	20	30	mW/sr
	I <sub>F</sub> = 1 A, t <sub>p</sub> = 100 μs	I <sub>e</sub>		170		mW/sr
Radiant power	I <sub>F</sub> = 100 mA, t <sub>p</sub> = 20 ms	φ <sub>e</sub>		40		mW
Temperature coefficient of radiant power	I <sub>F</sub> = 1 mA	TK <sub>φ<sub>e</sub></sub>		-1.1		%/K
	I <sub>F</sub> = 100 mA	TK <sub>φ<sub>e</sub></sub>		-0.51		%/K
Angle of half intensity		φ		± 25		deg
Peak wavelength	I <sub>F</sub> = 30 mA	λ <sub>p</sub>	920	940	960	nm
Spectral bandwidth	I <sub>F</sub> = 30 mA	Δλ		25		nm
Temperature coefficient of λ <sub>p</sub>	I <sub>F</sub> = 30 mA	TKλ <sub>p</sub>		0.25		nm/K
Rise time	I <sub>F</sub> = 100 mA, 20 % to 80 %	t <sub>r</sub>		15		ns
Fall time	I <sub>F</sub> = 100 mA, 20 % to 80 %	t <sub>f</sub>		15		ns
Cut-off frequency	I <sub>DC</sub> = 70 mA, I <sub>AC</sub> = 30 mA pp	f <sub>c</sub>		23		MHz

**BASIC CHARACTERISTICS** ( $T_{amb} = 25\text{ }^{\circ}\text{C}$ , unless otherwise specified)

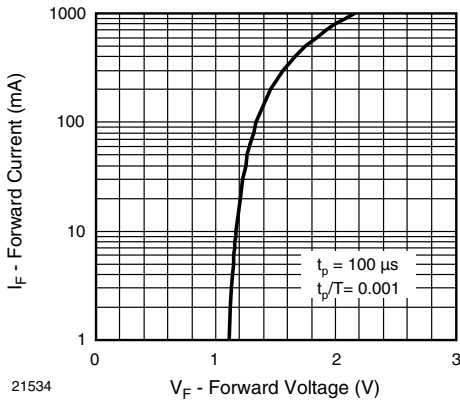

Fig. 3 - Forward Current vs. Forward Voltage

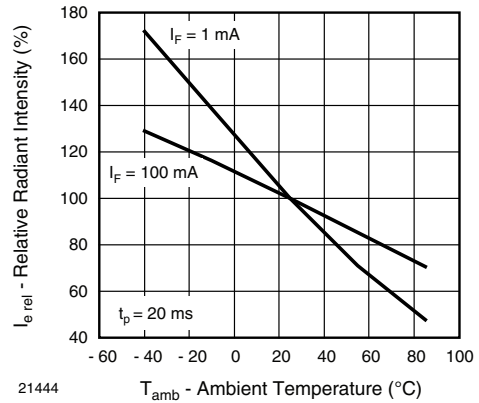

Fig. 6 - Relative Radiant Intensity vs. Ambient Temperature

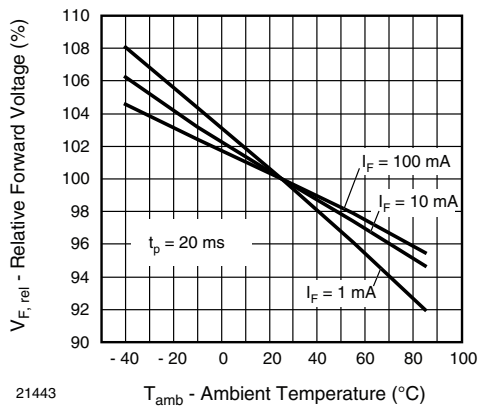

Fig. 4 - Relative Forward Voltage vs. Ambient Temperature

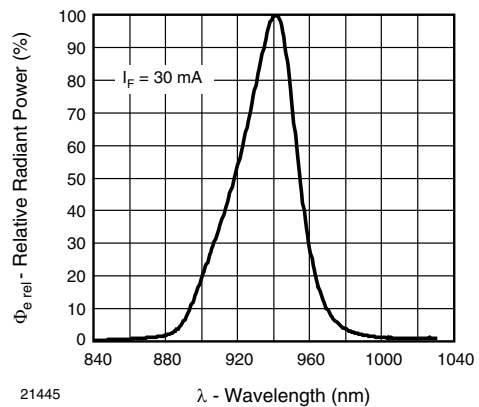

Fig. 7 - Relative Radiant Power vs. Wavelength

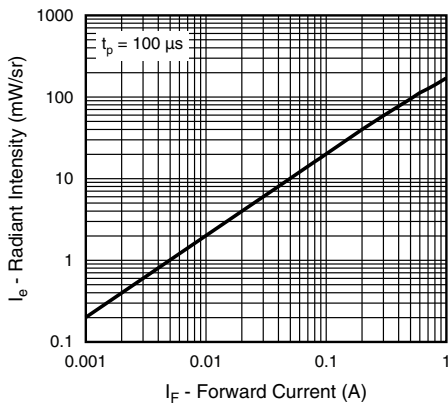

Fig. 5 - Radiant Intensity vs. Forward Current

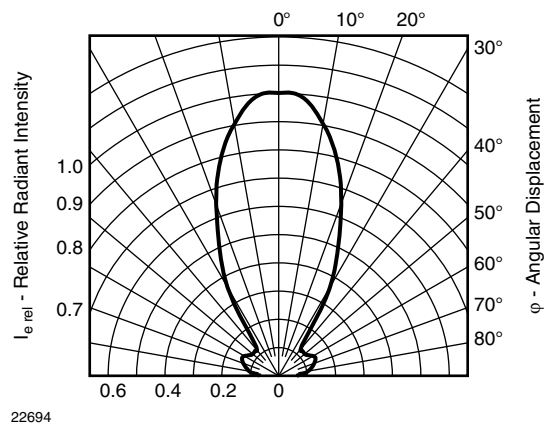

Fig. 8 - Relative Radiant Intensity vs. Angular Displacement

**SOLDER PROFILE**

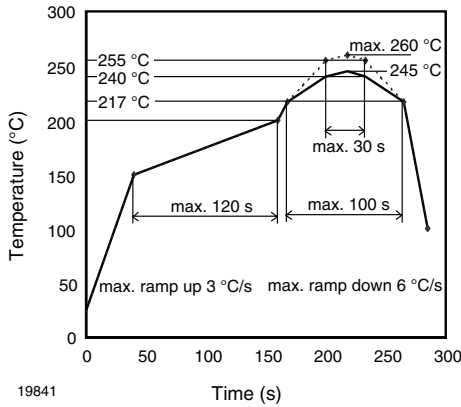

Fig. 9 - Lead (Pb)-free Reflow Solder Profile acc. J-STD-020

**DRYPACK**

Devices are packed in moisture barrier bags (MBB) to prevent the products from moisture absorption during transportation and storage. Each bag contains a desiccant.

**FLOOR LIFE**

Floor life (time between soldering and removing from MBB) must not exceed the time indicated on MBB label:  
 Floor life: 4 weeks  
 Conditions:  $T_{amb} < 30\text{ }^{\circ}\text{C}$ ,  $RH < 60\%$   
 Moisture sensitivity level 2a, acc. to J-STD-020.

**DRYING**

In case of moisture absorption devices should be baked before soldering. Conditions see J-STD-020 or label.  
 Devices taped on reel dry using recommended conditions 192 h at  $40\text{ }^{\circ}\text{C}$  ( $+5\text{ }^{\circ}\text{C}$ ),  $RH < 5\%$ .

**PACKAGE DIMENSIONS** in millimeters: **VSMB2943SL**

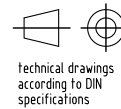
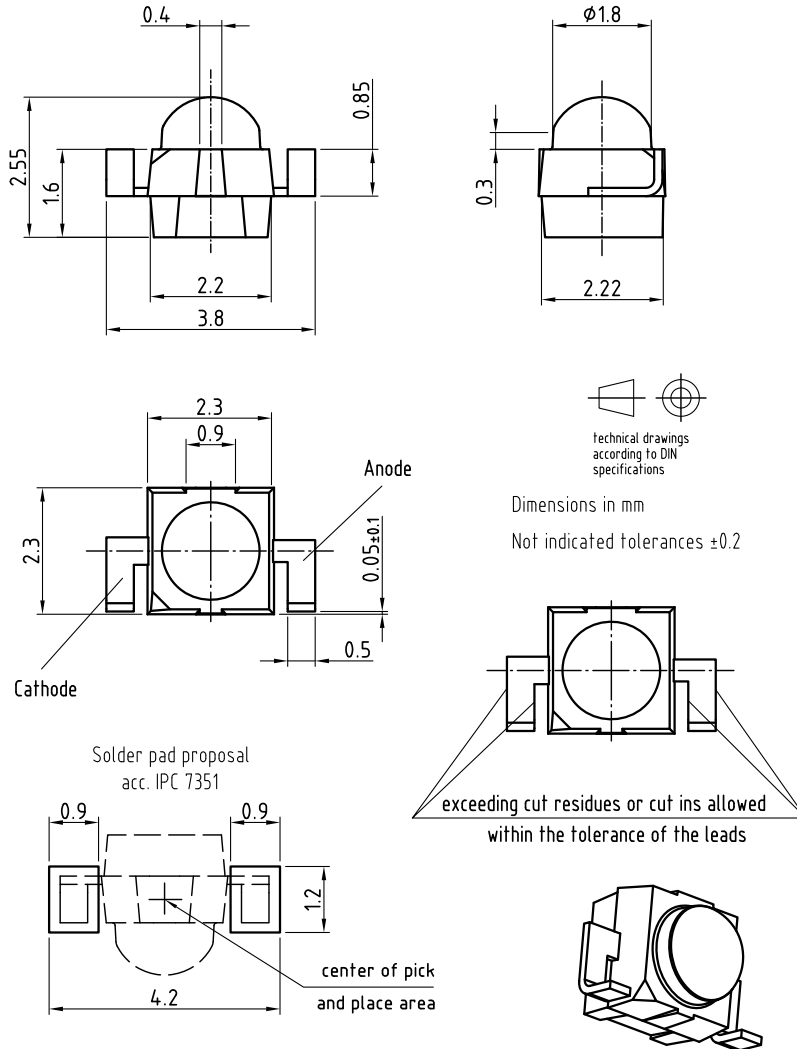

Technical drawings according to DIN specifications

Dimensions in mm  
 Not indicated tolerances  $\pm 0.2$

Drawing refers to following types: VSMB2943SLX01  
 VSMF2893SLX01  
 Drawing-No.: 6.544-5410.02-4 VSMB2948SL  
 Issue: prel. 03.08.12 VEMD2x23SLX01

**TAPING AND REEL DIMENSIONS in millimeters: VSMB2943SL**

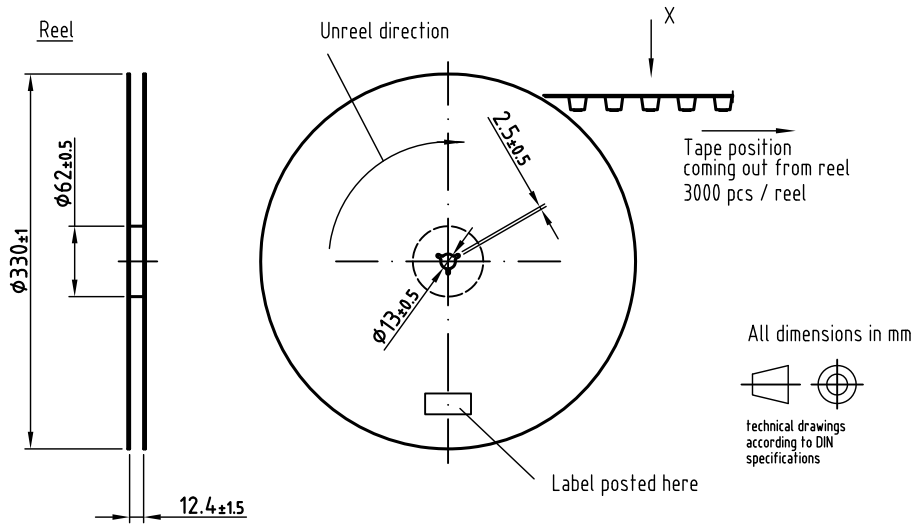

Leader and trailer tape:

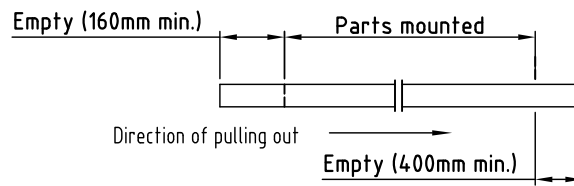

Terminal position in tape

Device	Lead I	Lead II
VSMB2943SLX01	Cathode	Anode
VSMF2893SLX01		
VSMB2948SL		
VEMD2023SLX01		
VEMD2523SLX01	Collector	Emitter
VEMT2023SLX01		
VEMT2523SLX01	Anode	Cathode
VSMY2853SL		

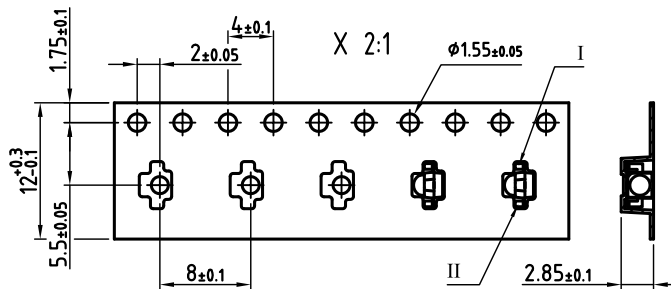

Drawing refers to following types: see table  
Reel dimensions and tape

Drawing-No.: 9.800-5123.01-4  
Issue: prel; 01.02.13



## **Disclaimer**

ALL PRODUCT, PRODUCT SPECIFICATIONS AND DATA ARE SUBJECT TO CHANGE WITHOUT NOTICE TO IMPROVE RELIABILITY, FUNCTION OR DESIGN OR OTHERWISE.

Vishay Intertechnology, Inc., its affiliates, agents, and employees, and all persons acting on its or their behalf (collectively, "Vishay"), disclaim any and all liability for any errors, inaccuracies or incompleteness contained in any datasheet or in any other disclosure relating to any product.

Vishay makes no warranty, representation or guarantee regarding the suitability of the products for any particular purpose or the continuing production of any product. To the maximum extent permitted by applicable law, Vishay disclaims (i) any and all liability arising out of the application or use of any product, (ii) any and all liability, including without limitation special, consequential or incidental damages, and (iii) any and all implied warranties, including warranties of fitness for particular purpose, non-infringement and merchantability.

Statements regarding the suitability of products for certain types of applications are based on Vishay's knowledge of typical requirements that are often placed on Vishay products in generic applications. Such statements are not binding statements about the suitability of products for a particular application. It is the customer's responsibility to validate that a particular product with the properties described in the product specification is suitable for use in a particular application. Parameters provided in datasheets and / or specifications may vary in different applications and performance may vary over time. All operating parameters, including typical parameters, must be validated for each customer application by the customer's technical experts. Product specifications do not expand or otherwise modify Vishay's terms and conditions of purchase, including but not limited to the warranty expressed therein.

Except as expressly indicated in writing, Vishay products are not designed for use in medical, life-saving, or life-sustaining applications or for any other application in which the failure of the Vishay product could result in personal injury or death. Customers using or selling Vishay products not expressly indicated for use in such applications do so at their own risk. Please contact authorized Vishay personnel to obtain written terms and conditions regarding products designed for such applications.

No license, express or implied, by estoppel or otherwise, to any intellectual property rights is granted by this document or by any conduct of Vishay. Product names and markings noted herein may be trademarks of their respective owners.