

## Low Current 0603 SMD LED

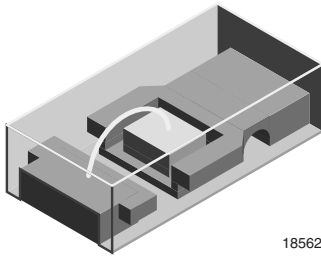

18562

### DESCRIPTION

The new 0603 LED series have been designed in the smallest SMD package. This innovative 0603 LED technology opens the way to

- Smaller products of higher performance
- More design in flexibility
- Enhanced applications

The 0603 LED is an obvious solution for small-scale, high power products that are expected to work reliability in an arduous environment.

### PRODUCT GROUP AND PACKAGE DATA

- Product group: LED
- Package: SMD 0603
- Product series: low current
- Angle of half intensity:  $\pm 80^\circ$

### FEATURES

- Smallest SMD package 0603 with exceptional brightness 1.6 mm x 0.8 mm x 0.6 mm (L x W x H)
- High reliability lead frame based
- Temperature range  $-40^\circ\text{C}$  to  $+100^\circ\text{C}$
- Footprint compatible to 0603 chipled
- Wavelength 633 nm (red), 606 nm (orange), 587 nm (yellow)
- AllnGaP technology
- Compatible to IR reflow soldering
- Viewing angle: Extremely wide  $160^\circ$
- Grouping parameter: Luminous intensity, wavelength
- Available in 8 mm tape
- Preconditioning according to JEDEC® level 2
- AEC-Q101 qualified
- Material categorization: for definitions of compliance please see [www.vishay.com/doc?99912](http://www.vishay.com/doc?99912)

AUTOMOTIVE GRADE

**RoHS**  
 COMPLIANT  
 HALOGEN  
**FREE**  
**GREEN**  
 (5-2008)

### APPLICATIONS

- Backlight keypads
- Navigation systems
- Cellular phone displays
- Displays for industrial control systems
- Automotive features
- Miniaturized color effects
- Traffic displays

### PARTS TABLE

PART	COLOR	LUMINOUS INTENSITY (mcd)			at $I_F$ (mA)	WAVELENGTH (nm)			at $I_F$ (mA)	FORWARD VOLTAGE (V)			at $I_F$ (mA)	TECHNOLOGY
		MIN.	TYP.	MAX.		MIN.	TYP.	MAX.		MIN.	TYP.	MAX.		
		TLMS1000-GS08	Red	1.8	4	-	2	624	628	636	2	-	1.8	
TLMO1000-GS08	Soft orange	3.55	7.5	-	2	600	605	609	2	-	1.8	2.6	2	AllnGaP
TLMY1000-GS08	Yellow	3.55	7.5	-	2	580	588	595	2	-	1.8	2.6	2	AllnGaP

### ABSOLUTE MAXIMUM RATINGS ( $T_{amb} = 25^\circ\text{C}$ , unless otherwise specified)

#### TLMS1000, TLMO1000, TLMY1000

PARAMETER	TEST CONDITION	SYMBOL	VALUE	UNIT
Reverse voltage <sup>(1)</sup>		$V_R$	12	V
DC Forward current	$T_{amb} \leq 95^\circ\text{C}$	$I_F$	15	mA
Surge forward current	$t_p \leq 10 \mu\text{s}$	$I_{FSM}$	0.1	A
Power dissipation		$P_V$	40	mW
Junction temperature		$T_j$	120	$^\circ\text{C}$
Operating temperature range		$T_{amb}$	-40 to +100	$^\circ\text{C}$
Storage temperature range		$T_{stg}$	-40 to +100	$^\circ\text{C}$
Soldering temperature	Acc. Vishay spec	$T_{sd}$	260	$^\circ\text{C}$
Thermal resistance junction/ambient	Mounted on PC board (pad size > 5 mm <sup>2</sup> )	$R_{thJA}$	500	K/W

#### Note

<sup>(1)</sup> Driving the LED in reverse direction is suitable for short term application

**OPTICAL AND ELECTRICAL CHARACTERISTICS** ( $T_{amb} = 25\text{ }^{\circ}\text{C}$ , unless otherwise specified)  
**TLMS1000, RED**

PARAMETER	TEST CONDITION	SYMBOL	MIN.	TYP.	MAX.	UNIT
Luminous intensity	$I_F = 2\text{ mA}$	$I_V$	1.8	4	-	mcd
Dominant wavelength	$I_F = 2\text{ mA}$	$\lambda_d$	624	628	636	nm
Peak wavelength	$I_F = 2\text{ mA}$	$\lambda_p$	-	640	-	nm
Angle of half intensity	$I_F = 2\text{ mA}$	$\varphi$	-	$\pm 80$	-	$^{\circ}$
Forward voltage	$I_F = 2\text{ mA}$	$V_F$	-	1.8	2.6	V
Reverse voltage	$I_R = 10\text{ }\mu\text{A}$	$V_R$	6	-	-	V
Junction capacitance	$V_R = 0\text{ V}$ , $f = 1\text{ MHz}$	$C_j$	-	15	-	pF

**OPTICAL AND ELECTRICAL CHARACTERISTICS** ( $T_{amb} = 25\text{ }^{\circ}\text{C}$ , unless otherwise specified)  
**TLMO1000, SOFT ORANGE**

PARAMETER	TEST CONDITION	SYMBOL	MIN.	TYP.	MAX.	UNIT
Luminous intensity	$I_F = 2\text{ mA}$	$I_V$	3.55	7.5	-	mcd
Dominant wavelength	$I_F = 2\text{ mA}$	$\lambda_d$	600	605	609	nm
Peak wavelength	$I_F = 2\text{ mA}$	$\lambda_p$	-	610	-	nm
Angle of half intensity	$I_F = 2\text{ mA}$	$\varphi$	-	$\pm 80$	-	$^{\circ}$
Forward voltage	$I_F = 2\text{ mA}$	$V_F$	-	1.8	2.6	V
Reverse voltage	$I_R = 10\text{ }\mu\text{A}$	$V_R$	6	-	-	V
Junction capacitance	$V_R = 0\text{ V}$ , $f = 1\text{ MHz}$	$C_j$	-	15	-	pF

**OPTICAL AND ELECTRICAL CHARACTERISTICS** ( $T_{amb} = 25\text{ }^{\circ}\text{C}$ , unless otherwise specified)  
**TLMY1000, YELLOW**

PARAMETER	TEST CONDITION	SYMBOL	MIN.	TYP.	MAX.	UNIT
Luminous intensity	$I_F = 2\text{ mA}$	$I_V$	3.55	7.5	-	mcd
Dominant wavelength	$I_F = 2\text{ mA}$	$\lambda_d$	580	588	595	nm
Peak wavelength	$I_F = 2\text{ mA}$	$\lambda_p$	-	591	-	nm
Angle of half intensity	$I_F = 2\text{ mA}$	$\varphi$	-	$\pm 80$	-	$^{\circ}$
Forward voltage	$I_F = 2\text{ mA}$	$V_F$	-	1.8	2.6	V
Reverse voltage	$I_R = 10\text{ }\mu\text{A}$	$V_R$	6	-	-	V
Junction capacitance	$V_R = 0\text{ V}$ , $f = 1\text{ MHz}$	$C_j$	-	15	-	pF

**COLOR CLASSIFICATION**

GROUP	DOMINANT WAVELENGTH (nm)			
	YELLOW		ORANGE	
	MIN.	MAX.	MIN.	MAX.
2	580	583	600	603
3	583	586	602	605
4	586	589	604	607
5	589	592	606	609
6	592	595		

**Note**

- Wavelengths are tested at a current pulse duration of 25 ms and an accuracy of  $\pm 1\text{ nm}$



LUMINOUS INTENSITY CLASSIFICATION		
GROUP	LUMINOUS INTENSITY (mcd)	
	MIN.	MAX.
G1	1.80	2.24
G2	2.24	2.80
H1	2.80	3.55
H2	3.55	4.50
J1	4.50	5.60
J2	5.60	7.10
K1	7.10	9.00
K2	9.00	11.20
L1	11.20	14.00
L2	14.00	18.00

**Note**

- Luminous intensity is tested at a current pulse duration of 25 ms and an accuracy of  $\pm 11\%$ .  
The above type numbers represent the order groups which include only a few brightness groups. Only one group will be shipped on each reel (there will be no mixing of two groups on each reel).  
In order to ensure availability, single brightness groups will not be orderable.  
In a similar manner for colors where wavelength groups are measured and binned, single wavelength groups will be shipped in any one reel.  
In order to ensure availability, single wavelength groups will not be orderable

**TYPICAL CHARACTERISTICS** ( $T_{amb} = 25\text{ }^{\circ}\text{C}$ , unless otherwise specified)

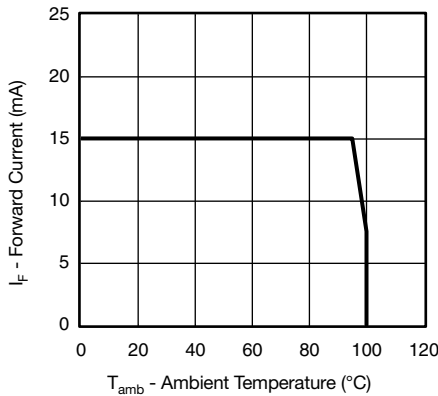

Fig. 1 - Forward Current vs. Ambient Temperature

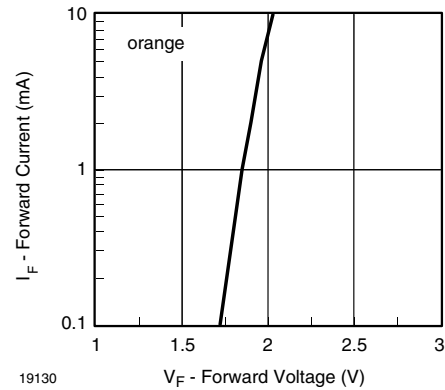

Fig. 3 - Forward Current vs. Forward Voltage

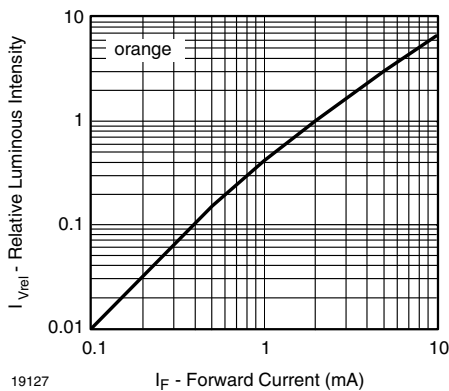

Fig. 2 - Relative Luminous Intensity vs. Forward Current

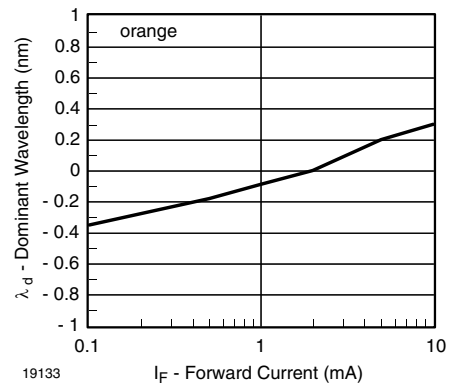

Fig. 4 - Dominant Wavelength vs. Forward Current

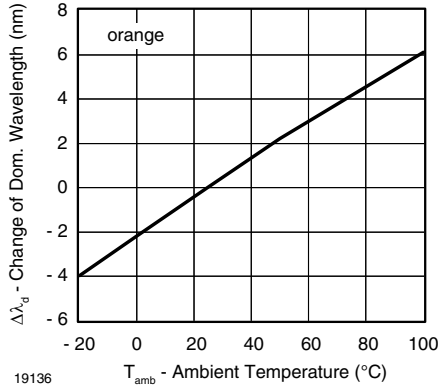

Fig. 5 - Change of Dominant Wavelength vs. Ambient Temperature

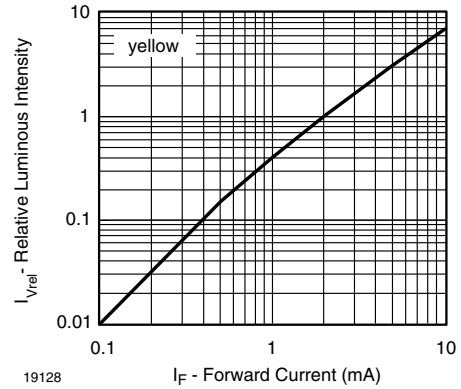

Fig. 8 - Relative Luminous Intensity vs. Forward Current

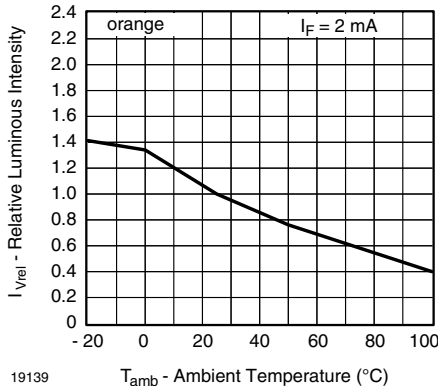

Fig. 6 - Relative Luminous Intensity vs. Ambient Temperature

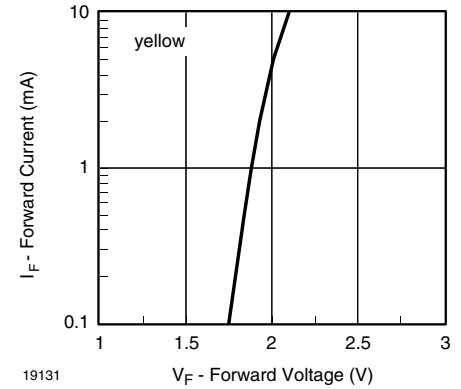

Fig. 9 - Forward Current vs. Forward Voltage

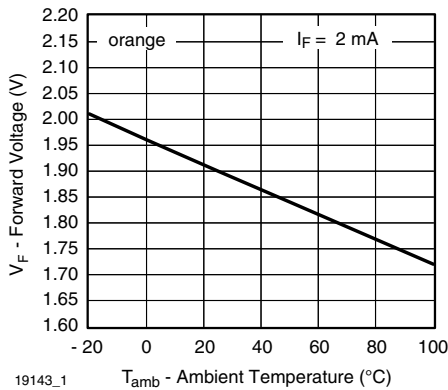

Fig. 7 - Forward Voltage vs. Ambient Temperature

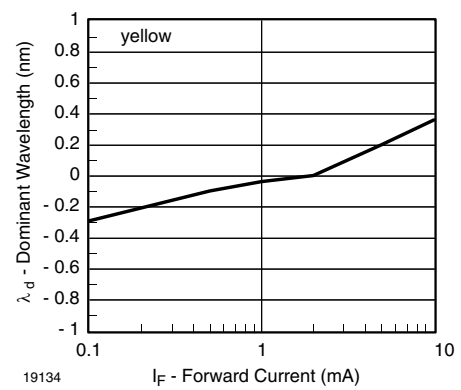

Fig. 10 - Dominant Wavelength vs. Forward Current

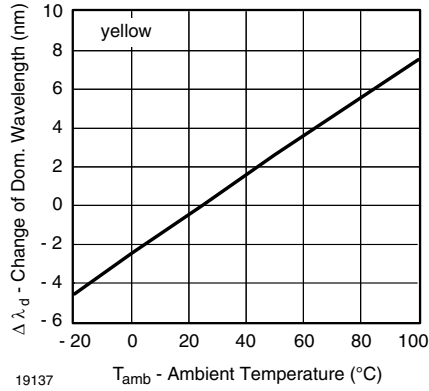

Fig. 11 - Change of Dominant Wavelength vs. Ambient Temperature

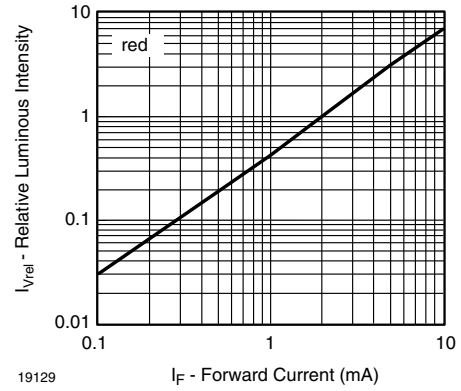

Fig. 14 - Relative Luminous Intensity vs. Forward Current

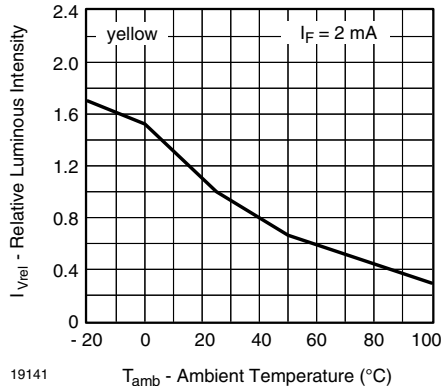

Fig. 12 - Relative Luminous Intensity vs. Ambient Temperature

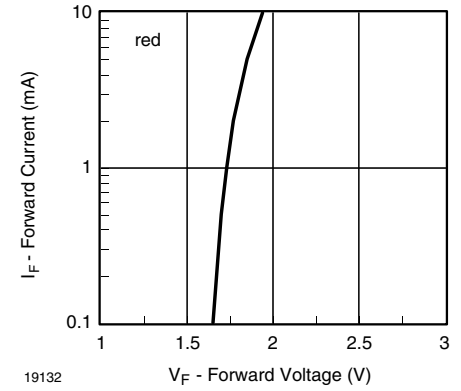

Fig. 15 - Forward Current vs. Forward Voltage

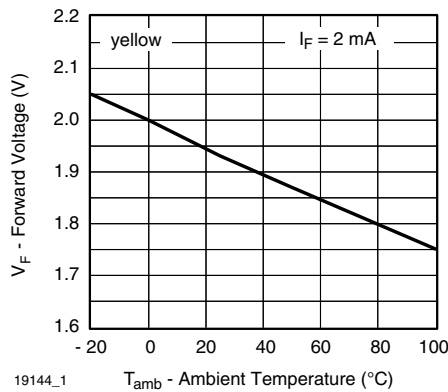

Fig. 13 - Forward Voltage vs. Ambient Temperature

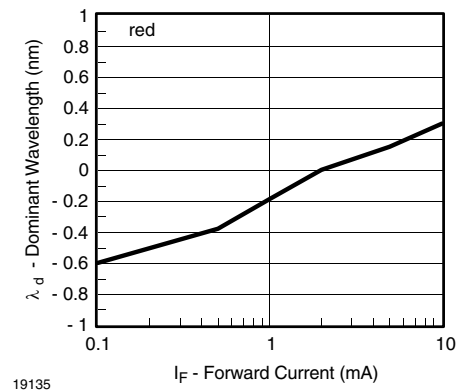

Fig. 16 - Dominant Wavelength vs. Forward Current

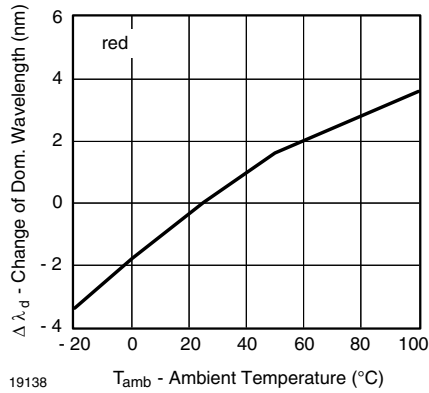

Fig. 17 - Change of Dominant Wavelength vs. Ambient Temperature

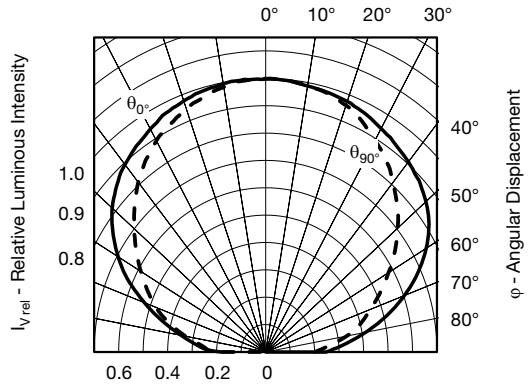

Fig. 20 - Relative Luminous Intensity vs. Angular Displacement

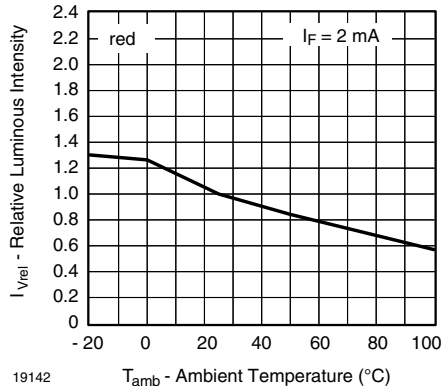

Fig. 18 - Relative Luminous Intensity vs. Ambient Temperature

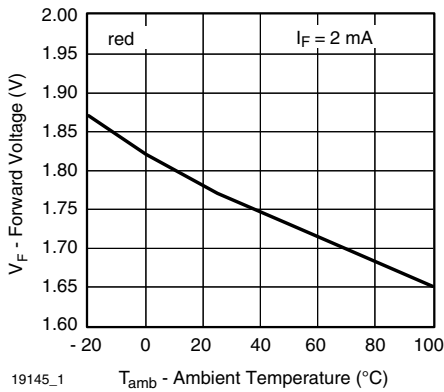
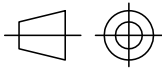
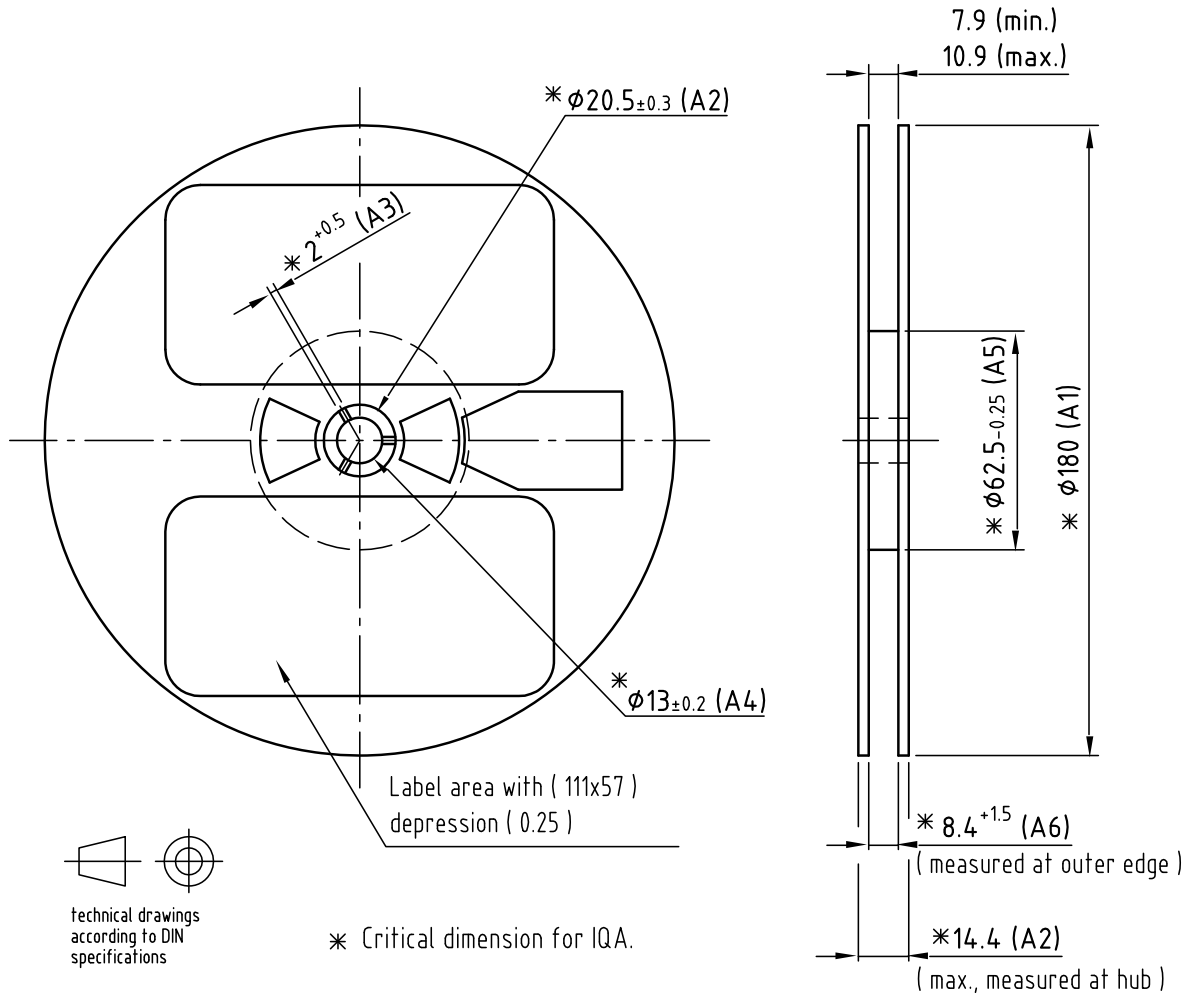

Fig. 19 - Forward Voltage vs. Ambient Temperature



## REEL DIMENSIONS in millimeters



technical drawings according to DIN specifications

Drawing-No.: 9.800-5086.01-4

Issue: 1; 29.04.04

19043

Not indicated tolerances  $\pm 0.05$

Material: black static dissipative



## TAPE DIMENSIONS in millimeters

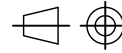
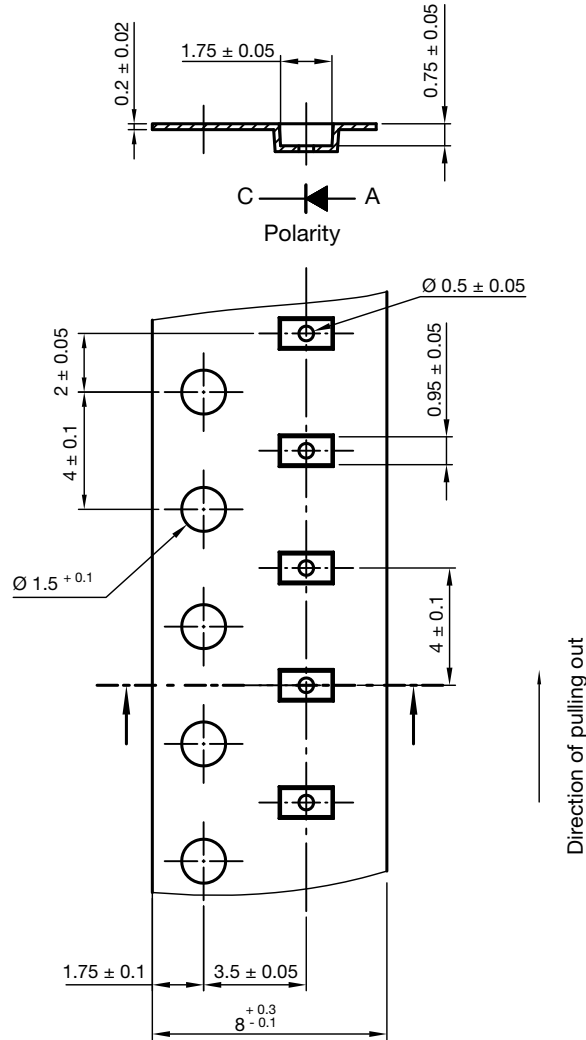

Technical drawings according to DIN specifications

Not indicated tolerances  $\pm 0.05$   
Material: Conductive black PC

Drawing-No.: 9.700-5290.01-4  
Issue: 3; 24.09.13





## PACKAGE DIMENSIONS in millimeters

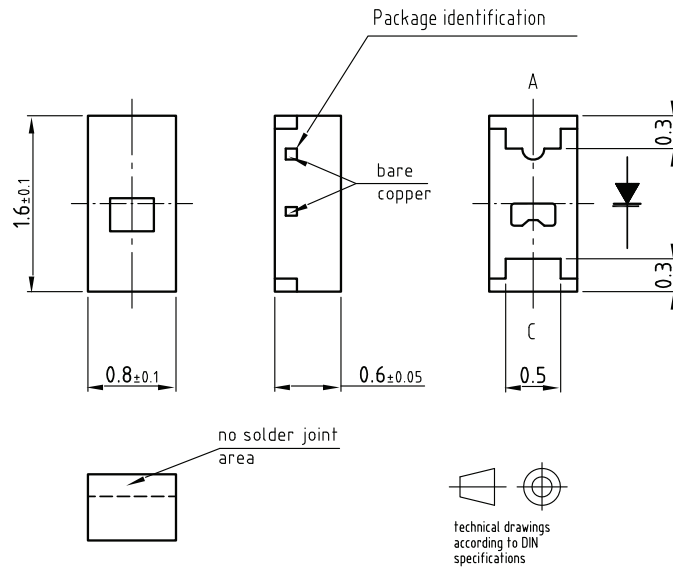

Not indicated tolerances ±0.1

Recommended solder pad

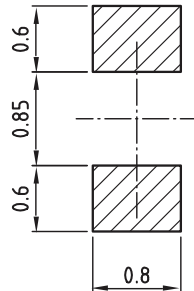

Drawing-No.: 6.541-5056.01-4

Issue: 2; 04.05.05

19426

## SOLDERING PROFILE

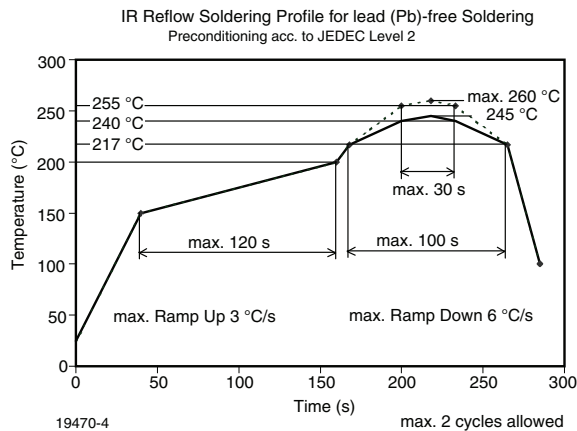
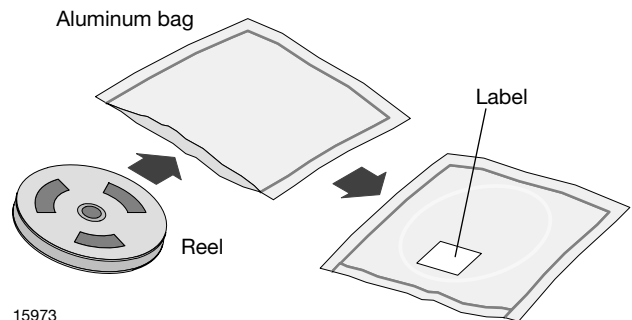

Fig. 21 - Vishay Lead (Pb)-free Reflow Soldering Profile (acc. to J-STD-020C)

## DRY PACKING

The reel is packed in an anti-humidity bag to protect the devices from absorbing moisture during transportation and storage.





**FINAL PACKING**

The sealed reel is packed into a cardboard box. A secondary cardboard box is used for shipping purposes.

**RECOMMENDED METHOD OF STORAGE**

Dry box storage is recommended as soon as the aluminum bag has been opened to prevent moisture absorption. The following conditions should be observed, if dry boxes are not available:

- Storage temperature 10 °C to 30 °C
- Storage humidity ≤ 60 % RH max.

After more than 1 year under these conditions moisture content will be too high for reflow soldering.

In case of moisture absorption, the devices will recover to the former condition by drying under the following condition:

- 192 h at 40 °C + 5 °C / - 0 °C and < 5 % RH (dry air/nitrogen) or
- 96 h at 60 °C + 5 °C and < 5 % RH for all device containers or
- 24 h at 100 °C + 5 °C not suitable for reel or tubes.

An EIA JEDEC standard JESD22-A112 level 2 label is included on all dry bags.

**ESD PRECAUTION**

Proper storage and handling procedures should be followed to prevent ESD damage to the devices especially when they are removed from the antistatic shielding bag. Electro-static sensitive devices warning labels are on the packaging.

**VISHAY SEMICONDUCTORS STANDARD BAR CODE LABEL**

The Vishay Semiconductors standard bar code labels are printed at final packing areas. The labels are on each packing unit and contain Vishay Semiconductors specific data.

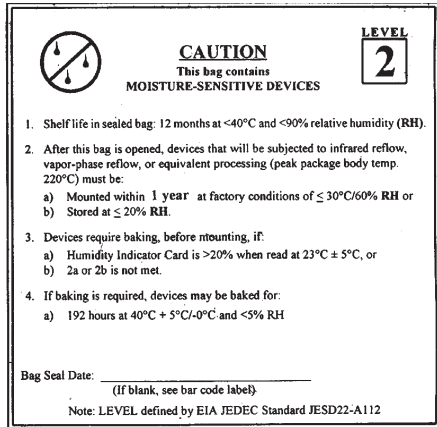

17028

Example of JESD22-A112 level 2 label



## **Disclaimer**

ALL PRODUCT, PRODUCT SPECIFICATIONS AND DATA ARE SUBJECT TO CHANGE WITHOUT NOTICE TO IMPROVE RELIABILITY, FUNCTION OR DESIGN OR OTHERWISE.

Vishay Intertechnology, Inc., its affiliates, agents, and employees, and all persons acting on its or their behalf (collectively, "Vishay"), disclaim any and all liability for any errors, inaccuracies or incompleteness contained in any datasheet or in any other disclosure relating to any product.

Vishay makes no warranty, representation or guarantee regarding the suitability of the products for any particular purpose or the continuing production of any product. To the maximum extent permitted by applicable law, Vishay disclaims (i) any and all liability arising out of the application or use of any product, (ii) any and all liability, including without limitation special, consequential or incidental damages, and (iii) any and all implied warranties, including warranties of fitness for particular purpose, non-infringement and merchantability.

Statements regarding the suitability of products for certain types of applications are based on Vishay's knowledge of typical requirements that are often placed on Vishay products in generic applications. Such statements are not binding statements about the suitability of products for a particular application. It is the customer's responsibility to validate that a particular product with the properties described in the product specification is suitable for use in a particular application. Parameters provided in datasheets and / or specifications may vary in different applications and performance may vary over time. All operating parameters, including typical parameters, must be validated for each customer application by the customer's technical experts. Product specifications do not expand or otherwise modify Vishay's terms and conditions of purchase, including but not limited to the warranty expressed therein.

Except as expressly indicated in writing, Vishay products are not designed for use in medical, life-saving, or life-sustaining applications or for any other application in which the failure of the Vishay product could result in personal injury or death. Customers using or selling Vishay products not expressly indicated for use in such applications do so at their own risk. Please contact authorized Vishay personnel to obtain written terms and conditions regarding products designed for such applications.

No license, express or implied, by estoppel or otherwise, to any intellectual property rights is granted by this document or by any conduct of Vishay. Product names and markings noted herein may be trademarks of their respective owners.