

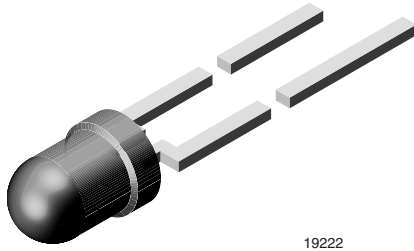

High Efficiency LED in Ø 3 mm Clear Package



19222

DESCRIPTION

The TLH.4900 series was developed for applications where high light output is required.

It is housed in a 3 mm clear plastic package. The small viewing angle of these devices provides a high brightness.

All LEDs are categorized in luminous intensity groups. The green and yellow LEDs are categorized additionally in wavelength groups.

That allows users to assemble LEDs with uniform appearance.

PRODUCT GROUP AND PACKAGE DATA

- Product group: LED
- Package: 3 mm
- Product series: standard
- Angle of half intensity: $\pm 16^\circ$

FEATURES

- Choice of four bright colors
- Standard Ø 3 mm (T-1) package
- Small mechanical tolerances
- Suitable for DC and high peak current
- Very small viewing angle
- Luminous intensity categorized
- Yellow and green color categorized
- Material categorization: for definitions of compliance please see www.vishay.com/doc?99912



APPLICATIONS

- Status lights
- Off / on indicator
- Background illumination
- Readout lights
- Maintenance lights
- Legend light

PARTS TABLE														
PART	COLOR	LUMINOUS INTENSITY (mcd)			at I _F (mA)	WAVELENGTH (nm)			at I _F (mA)	FORWARD VOLTAGE (V)			at I _F (mA)	TECHNOLOGY
		MIN.	TYP.	MAX.		MIN.	TYP.	MAX.		MIN.	TYP.	MAX.		
TLHR4900	Red	6.3	25	-	10	612	-	625	10	-	2	3	20	GaAsP on GaP
TLHY4900	Yellow	10	26	-	10	581	-	594	10	-	2.4	3	20	GaAsP on GaP
TLHG4900	Green	16	37	-	10	562	-	575	10	-	2.4	3	20	GaP on GaP

ABSOLUTE MAXIMUM RATINGS (T _{amb} = 25 °C, unless otherwise specified) TLHG4900, TLHR4900, TLHY4900				
PARAMETER	TEST CONDITION	SYMBOL	VALUE	UNIT
Reverse voltage		V _R	6	V
DC forward current	T _{amb} ≤ 60 °C	I _F	30	mA
Surge forward current	t _p ≤ 10 μs	I _{FSM}	1	A
Power dissipation	T _{amb} ≤ 60 °C	P _V	100	mW
Junction temperature		T _j	100	°C
Operating temperature range		T _{amb}	-40 to +100	°C
Storage temperature range		T _{stg}	-55 to +100	°C
Soldering temperature	t ≤ 5 s, 2 mm from body	T _{sd}	260	°C
Thermal resistance junction-to.ambient		R _{thJA}	400	K/W



OPTICAL AND ELECTRICAL CHARACTERISTICS ($T_{amb} = 25\text{ }^{\circ}\text{C}$, unless otherwise specified)
TLHR4900, RED

PARAMETER	TEST CONDITION	SYMBOL	MIN.	TYP.	MAX.	UNIT
Luminous intensity ⁽¹⁾	$I_F = 10\text{ mA}$	I_V	6.3	25	-	mcd
Dominant wavelength	$I_F = 10\text{ mA}$	λ_d	612	-	625	nm
Peak wavelength	$I_F = 10\text{ mA}$	λ_p	-	635	-	nm
Angle of half intensity	$I_F = 10\text{ mA}$	ϕ	-	± 16	-	$^{\circ}$
Forward voltage	$I_F = 20\text{ mA}$	V_F	-	2	3	V
Reverse voltage	$I_R = 10\text{ }\mu\text{A}$	V_R	6	15	-	V
Junction capacitance	$V_R = 0\text{ V}$, $f = 1\text{ MHz}$	C_j	-	50	-	pF

Note

⁽¹⁾ In one packing unit $I_{Vmin.}/I_{Vmax.} \leq 0.5$

OPTICAL AND ELECTRICAL CHARACTERISTICS ($T_{amb} = 25\text{ }^{\circ}\text{C}$, unless otherwise specified)
TLHY4900, YELLOW

PARAMETER	TEST CONDITION	SYMBOL	MIN.	TYP.	MAX.	UNIT
Luminous intensity ⁽¹⁾	$I_F = 10\text{ mA}$	I_V	10	26	-	mcd
Dominant wavelength	$I_F = 10\text{ mA}$	λ_d	581	-	594	nm
Peak wavelength	$I_F = 10\text{ mA}$	λ_p	-	585	-	nm
Angle of half intensity	$I_F = 10\text{ mA}$	ϕ	-	± 16	-	$^{\circ}$
Forward voltage	$I_F = 20\text{ mA}$	V_F	-	2.4	3	V
Reverse voltage	$I_R = 10\text{ }\mu\text{A}$	V_R	6	15	-	V
Junction capacitance	$V_R = 0\text{ V}$, $f = 1\text{ MHz}$	C_j	-	50	-	pF

Note

⁽¹⁾ In one packing unit $I_{Vmin.}/I_{Vmax.} \leq 0.5$

OPTICAL AND ELECTRICAL CHARACTERISTICS ($T_{amb} = 25\text{ }^{\circ}\text{C}$, unless otherwise specified)
TLHG4900, GREEN

PARAMETER	TEST CONDITION	SYMBOL	MIN.	TYP.	MAX.	UNIT
Luminous intensity ⁽¹⁾	$I_F = 10\text{ mA}$	I_V	16	37	-	mcd
Dominant wavelength	$I_F = 10\text{ mA}$	λ_d	562	-	575	nm
Peak wavelength	$I_F = 10\text{ mA}$	λ_p	-	565	-	nm
Angle of half intensity	$I_F = 10\text{ mA}$	ϕ	-	± 16	-	$^{\circ}$
Forward voltage	$I_F = 20\text{ mA}$	V_F	-	2.4	3	V
Reverse voltage	$I_R = 10\text{ }\mu\text{A}$	V_R	6	15	-	V
Junction capacitance	$V_R = 0\text{ V}$, $f = 1\text{ MHz}$	C_j	-	50	-	pF

Note

⁽¹⁾ In one packing unit $I_{Vmin.}/I_{Vmax.} \leq 0.5$

LUMINOUS INTENSITY CLASSIFICATION

GROUP	LUMINOUS INTENSITY (mcd)	
	MIN.	MAX.
Q	6.3	12.5
R	10	20
S	16	32
T	25	50
U	40	80
V	63	125

Note

- The above type numbers represent the order groups which include only a few brightness groups. Only one group will be shipped on each reel or bulk (there will be no mixing of two groups on one reel/bulk). In order to ensure availability, single brightness groups will not be orderable. In a similar manner for colors where wavelength groups are measured and binned, single wavelength groups will be shipped on any one reel/bulk. In order to ensure availability, single wavelength groups will not be orderable

COLOR CLASSIFICATION

GROUP	DOM. WAVELENGTH (nm)			
	YELLOW		GREEN	
	MIN.	MAX.	MIN.	MAX.
0				
1	581	584		
2	583	586		
3	585	588	562	565
4	587	590	564	567
5	589	592	566	569
6	591	594	568	571
7			570	573
8			572	575

Note

- Wavelengths are tested at a current pulse duration of 25 ms

TYPICAL CHARACTERISTICS ($T_{amb} = 25\text{ }^{\circ}\text{C}$, unless otherwise specified)

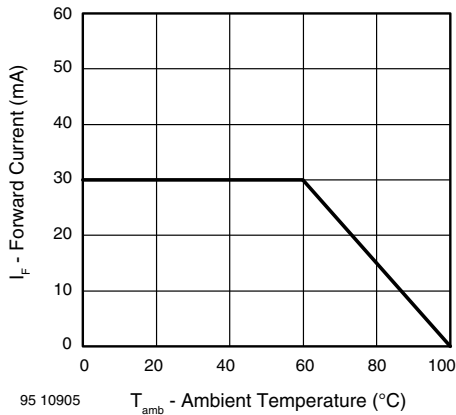

Fig. 1 - Forward Current vs. Ambient Temperature

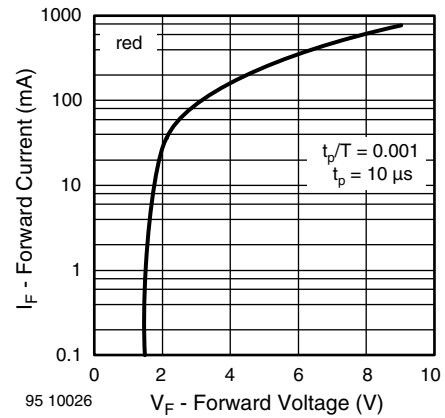

Fig. 4 - Forward Current vs. Forward Voltage

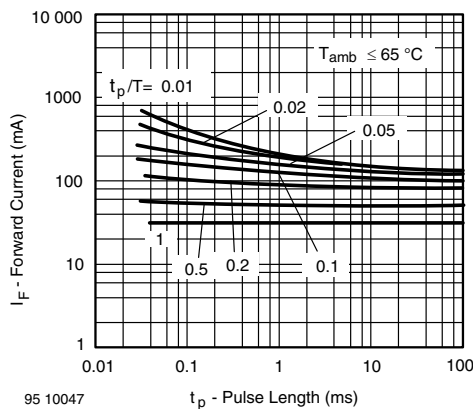

Fig. 2 - Forward Current vs. Pulse Length

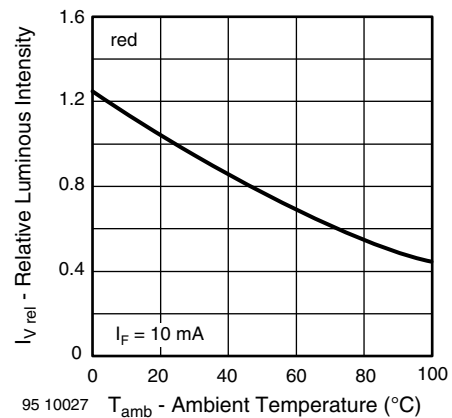

Fig. 5 - Relative Luminous Intensity vs. Ambient Temperature

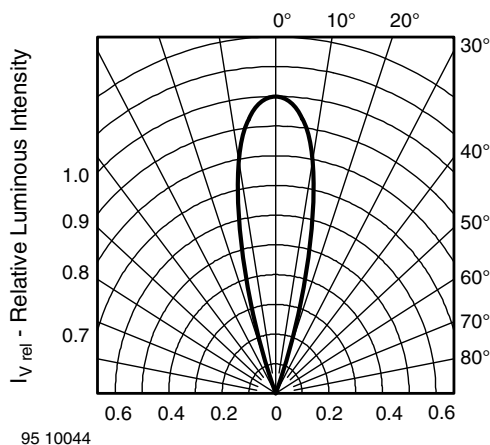

Fig. 3 - Relative Luminous Intensity vs. Angular Displacement

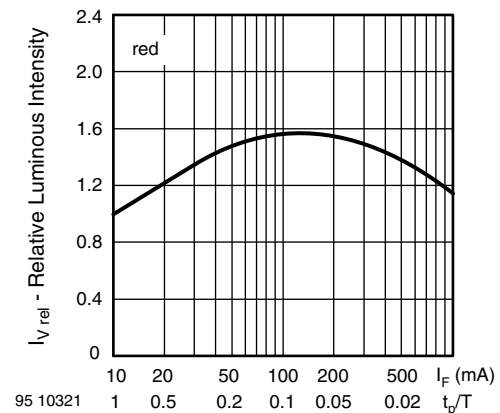

Fig. 6 - Relative Luminous Intensity vs. Forward Current/Duty Cycle



Fig. 7 - Relative Luminous Intensity vs. Forward Current



Fig. 10 - Relative Luminous Intensity vs. Ambient Temperature



Fig. 8 - Relative Intensity vs. Wavelength

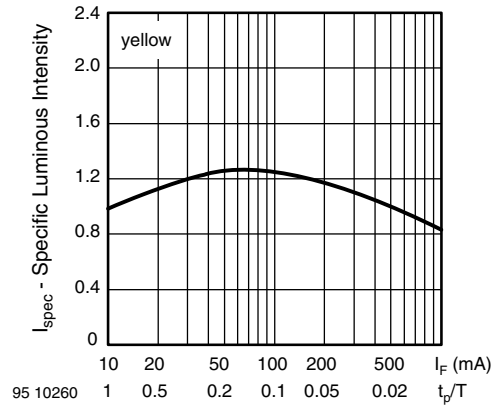

Fig. 11 - Relative Luminous Intensity vs. Forward Current/Duty Cycle



Fig. 9 - Forward Current vs. Forward Voltage

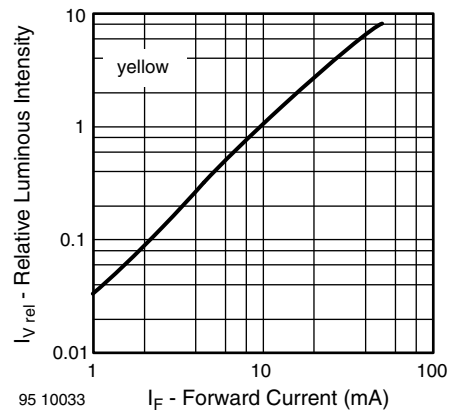

Fig. 12 - Relative Luminous Intensity vs. Forward Current



Fig. 13 - Relative Intensity vs. Wavelength

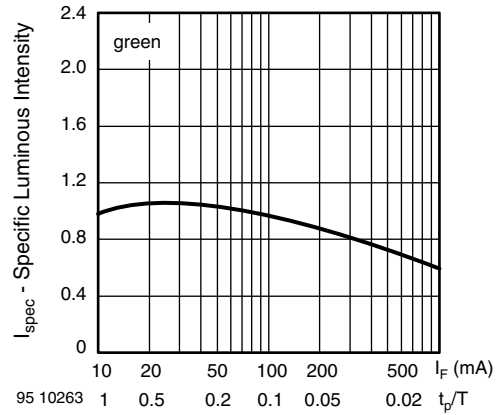

Fig. 16 - Specific Luminous Intensity vs. Forward Current

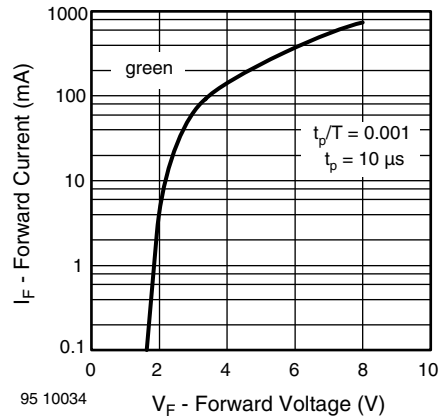

Fig. 14 - Forward Current vs. Forward Voltage

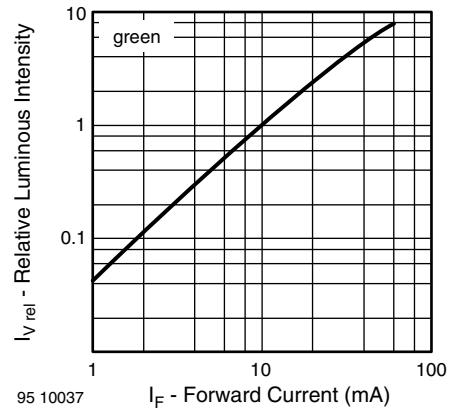

Fig. 17 - Relative Luminous Intensity vs. Forward Current

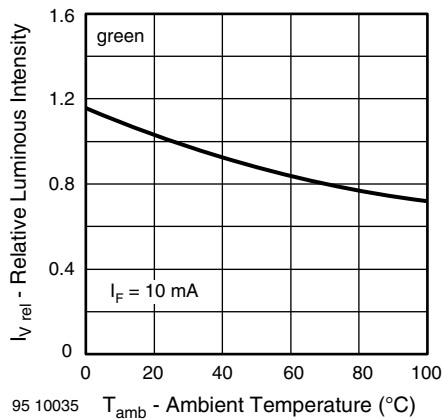

Fig. 15 - Rel. Luminous Intensity vs. Ambient Temperature

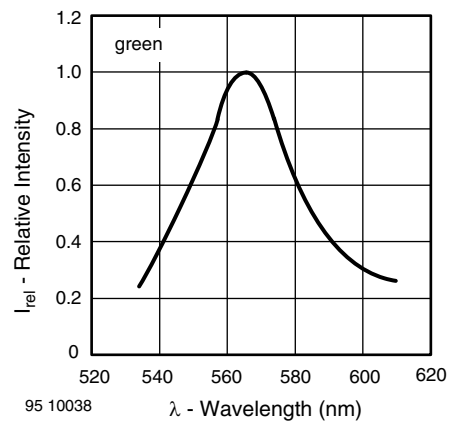
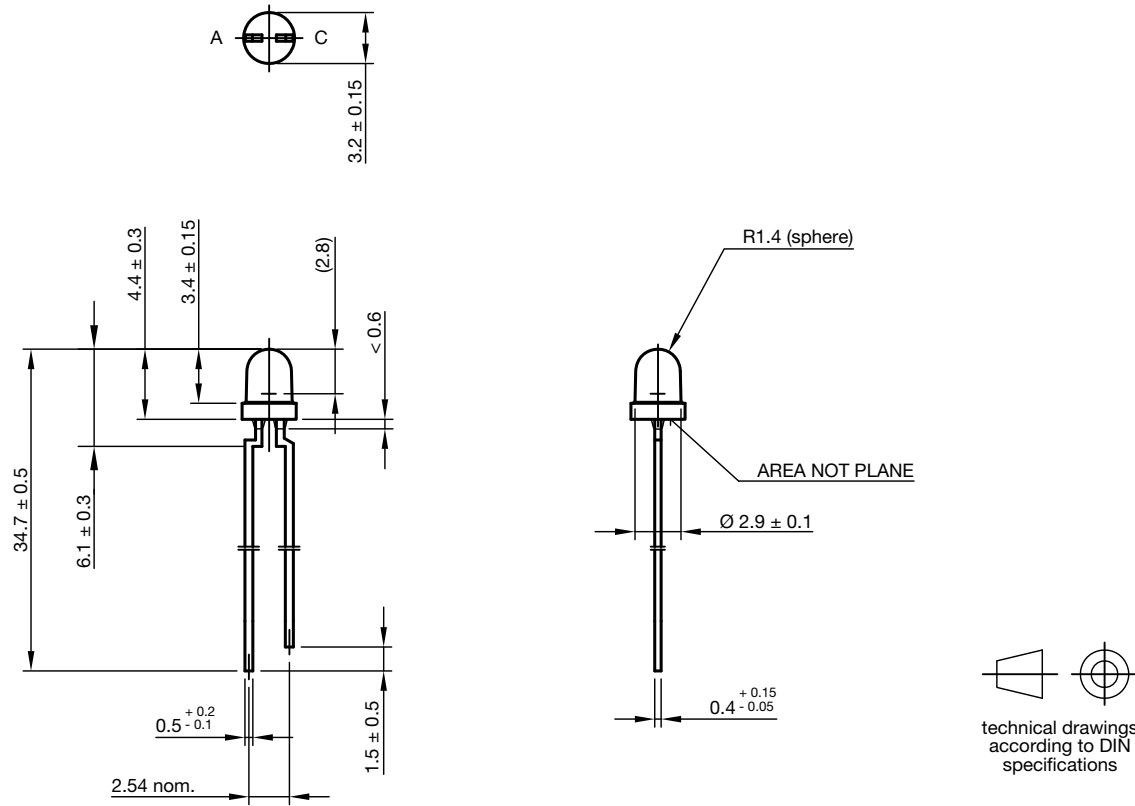

Fig. 18 - Relative Intensity vs. Wavelength



PACKAGE DIMENSIONS in millimeters



Drawing-No.: 6.544-5255.02-4
Issue: 5; 28.07.14



Disclaimer

ALL PRODUCT, PRODUCT SPECIFICATIONS AND DATA ARE SUBJECT TO CHANGE WITHOUT NOTICE TO IMPROVE RELIABILITY, FUNCTION OR DESIGN OR OTHERWISE.

Vishay Intertechnology, Inc., its affiliates, agents, and employees, and all persons acting on its or their behalf (collectively, "Vishay"), disclaim any and all liability for any errors, inaccuracies or incompleteness contained in any datasheet or in any other disclosure relating to any product.

Vishay makes no warranty, representation or guarantee regarding the suitability of the products for any particular purpose or the continuing production of any product. To the maximum extent permitted by applicable law, Vishay disclaims (i) any and all liability arising out of the application or use of any product, (ii) any and all liability, including without limitation special, consequential or incidental damages, and (iii) any and all implied warranties, including warranties of fitness for particular purpose, non-infringement and merchantability.

Statements regarding the suitability of products for certain types of applications are based on Vishay's knowledge of typical requirements that are often placed on Vishay products in generic applications. Such statements are not binding statements about the suitability of products for a particular application. It is the customer's responsibility to validate that a particular product with the properties described in the product specification is suitable for use in a particular application. Parameters provided in datasheets and / or specifications may vary in different applications and performance may vary over time. All operating parameters, including typical parameters, must be validated for each customer application by the customer's technical experts. Product specifications do not expand or otherwise modify Vishay's terms and conditions of purchase, including but not limited to the warranty expressed therein.

Except as expressly indicated in writing, Vishay products are not designed for use in medical, life-saving, or life-sustaining applications or for any other application in which the failure of the Vishay product could result in personal injury or death. Customers using or selling Vishay products not expressly indicated for use in such applications do so at their own risk. Please contact authorized Vishay personnel to obtain written terms and conditions regarding products designed for such applications.

No license, express or implied, by estoppel or otherwise, to any intellectual property rights is granted by this document or by any conduct of Vishay. Product names and markings noted herein may be trademarks of their respective owners.