

Inverter Grade Thyristors (Stud Version), 195 A



TO-93 (TO-209AB)

FEATURES

- Center amplifying gate
- High surge current capability
- Low thermal impedance
- High speed performance
- Compression bonding
- Designed and qualified for industrial level
- Material categorization: for definitions of compliance please see www.vishay.com/doc?99912

**RoHS
COMPLIANT**

PRIMARY CHARACTERISTICS	
$I_{T(AV)}$	195 A
V_{DRM}/V_{RRM}	400 V, 800 V
V_{TM}	1.80 V
I_{TSM} at 50 Hz	4900 A
I_{TSM} at 60 Hz	5130 A
I_{GT}	200 mA
T_J	-40 °C to 125 °C
T_C	85 °C
Package	TO-93 (TO-209AB)
Circuit configuration	Single SCR

TYPICAL APPLICATIONS

- Inverters
- Choppers
- Induction heating
- All types of force-commutated converters

MAJOR RATINGS AND CHARACTERISTICS			
PARAMETER	TEST CONDITIONS	VALUES	UNITS
$I_{T(AV)}$		195	A
	T_C	85	°C
$I_{T(RMS)}$		306	A
I_{TSM}	50 Hz	4900	
	60 Hz	5130	
I^2t	50 Hz	120	kA ² s
	60 Hz	110	
V_{DRM}/V_{RRM}		400 to 800	V
t_q		15 to 20	µs
T_J		-40 to 125	°C

ELECTRICAL SPECIFICATIONS

VOLTAGE RATINGS				
TYPE NUMBER	VOLTAGE CODE	V_{DRM}/V_{RRM} , MAXIMUM REPETITIVE PEAK VOLTAGE V	V_{RSM} , MAXIMUM NON-REPETITIVE PEAK VOLTAGE V	I_{DRM}/I_{RRM} MAXIMUM AT $T_J = T_J$ MAXIMUM mA
VS-ST183S	04	400	500	40
	08	800	900	



CURRENT CARRYING CAPABILITY							
FREQUENCY							UNITS
50 Hz	570	370	900	610	7040	5220	A
400 Hz	560	360	940	630	3200	2280	
1000 Hz	500	300	925	610	1780	1200	
2500 Hz	340	190	760	490	880	560	
Recovery voltage V_r	50		50		50		V
Voltage before turn-on V_d	V_{DRM}		V_{DRM}		V_{DRM}		
Rise of on-state current di/dt	50		-		-		A/μs
Case temperature	60	85	60	85	60	85	°C
Equivalent values for RC circuit	47/0.22		47/0.22		47/0.22		Ω/μF

ON-STATE CONDUCTION					
PARAMETER	SYMBOL	TEST CONDITIONS		VALUES	UNITS
Maximum average on-state current at case temperature	$I_{T(AV)}$	180° conduction, half sine wave		195	A
				85	°C
Maximum RMS on-state current	$I_{T(RMS)}$	DC at 74 °C case temperature		306	A
Maximum peak, one half cycle, non-repetitive surge current	I_{TSM}	t = 10 ms	No voltage reapplied	4900	
		t = 8.3 ms	No voltage reapplied	5130	
		t = 10 ms	100 % V_{RRM} reapplied	4120	
		t = 8.3 ms	100 % V_{RRM} reapplied	4310	
Maximum I^2t for fusing	I^2t	t = 10 ms	No voltage reapplied	120	kA ² s
		t = 8.3 ms	No voltage reapplied	110	
		t = 10 ms	100 % V_{RRM} reapplied	85	
		t = 8.3 ms	100 % V_{RRM} reapplied	78	
Maximum $I^2\sqrt{t}$ for fusing	$I^2\sqrt{t}$	t = 0.1 to 10 ms, no voltage reapplied		1200	kA ² /s
Maximum peak on-state voltage	V_{TM}	$I_{TM} = 600$ A, $T_J = T_J$ maximum, $t_p = 10$ ms sine wave pulse		1.80	V
Low level value of threshold voltage	$V_{T(TO)1}$	$(16.7 \% \times \pi \times I_{T(AV)}) < I < \pi \times I_{T(AV)}$, $T_J = T_J$ maximum		1.40	
High level value of threshold voltage	$V_{T(TO)2}$	$I > \pi \times I_{T(AV)}$, $T_J = T_J$ maximum		1.45	
Low level value of forward slope resistance	r_{t1}	$(16.7 \% \times \pi \times I_{T(AV)}) < I < \pi \times I_{T(AV)}$, $T_J = T_J$ maximum		0.67	mΩ
High level value of forward slope resistance	r_{t2}	$I > \pi \times I_{T(AV)}$, $T_J = T_J$ maximum		0.58	
Maximum holding current	I_H	$T_J = 25$ °C, $I_T > 30$ A		600	mA
Typical latching current	I_L	$T_J = 25$ °C, $V_A = 12$ V, $R_a = 6$ Ω, $I_G = 1$ A		1000	

SWITCHING					
PARAMETER	SYMBOL	TEST CONDITIONS		VALUES	UNITS
Maximum non-repetitive rate of rise of turned-on current	di/dt	$T_J = T_J$ maximum, $V_{DRM} = \text{Rated } V_{DRM}$ $I_{TM} = 2 \times di/dt$		1000	A/μs
Typical delay time	t_d	$T_J = 25$ °C, $V_{DM} = \text{Rated } V_{DRM}$, $I_{TM} = 50$ A DC, $t_p = 1$ μs Resistive load, gate pulse: 10 V, 5 Ω source		1.1	μs
Maximum turn-off time	t_q	$T_J = T_J$ maximum, $I_{TM} = 300$ A, commutating $di/dt = 20$ A/μs $V_R = 50$ V, $t_p = 500$ μs, $dV/dt = 200$ V/μs		15	
				20	



BLOCKING				
PARAMETER	SYMBOL	TEST CONDITIONS	VALUES	UNITS
Maximum critical rate of rise of off-state voltage	dV/dt	T _J = T _J maximum, linear to 80 % V _{DRM} , higher value available on request	500	V/μs
Maximum peak reverse and off-state leakage current	I _{RRM} , I _{DRM}	T _J = T _J maximum, rated V _{DRM} /V _{RRM} applied	40	mA

TRIGGERING				
PARAMETER	SYMBOL	TEST CONDITIONS	VALUES	UNITS
Maximum peak gate power	P _{GM}	T _J = T _J maximum, f = 50 Hz, d% = 50	60	W
Maximum average gate power	P _{G(AV)}		10	
Maximum peak positive gate current	I _{GM}	T _J = T _J maximum, t _p ≤ 5 ms	10	A
Maximum peak positive gate voltage	+ V _{GM}		20	
Maximum peak negative gate voltage	- V _{GM}		5	
Maximum DC gate current required to trigger	I _{GT}	T _J = T _J maximum V _A = 12 V, R _a = 6 Ω	200	mA
Maximum DC gate voltage required to trigger	V _{GT}		3	
Maximum DC gate current not to trigger	I _{GD}	T _J = T _J maximum, rated V _{DRM} applied	20	mA
Maximum DC gate voltage not to trigger	V _{GD}		0.25	

THERMAL AND MECHANICAL SPECIFICATIONS				
PARAMETER	SYMBOL	TEST CONDITIONS	VALUES	UNITS
Maximum junction operating temperature range	T _J		-40 to 125	°C
Maximum storage temperature range	T _{Stg}		-40 to 150	
Maximum thermal resistance, junction to case	R _{thJC}	DC operation	0.105	K/W
Maximum thermal resistance, case to heatsink	R _{thCS}	Mounting surface, smooth, flat and greased	0.04	
Mounting torque, ± 10 %		Non-lubricated threads	31 (275)	N · m (lbf · in)
		Lubricated threads	24.5 (210)	
Approximate weight			280	g
Case style		See dimensions - link at the end of datasheet	TO-93 (TO-209AB)	

ΔR _{thJC} CONDUCTION				
CONDUCTION ANGLE	SINUSOIDAL CONDUCTION	RECTANGULAR CONDUCTION	TEST CONDITIONS	UNITS
180°	0.016	0.012	T _J = T _J maximum	K/W
120°	0.019	0.020		
90°	0.025	0.027		
60°	0.036	0.037		
30°	0.060	0.060		

Note

- The table above shows the increment of thermal resistance R_{thJC} when devices operate at different conduction angles than DC

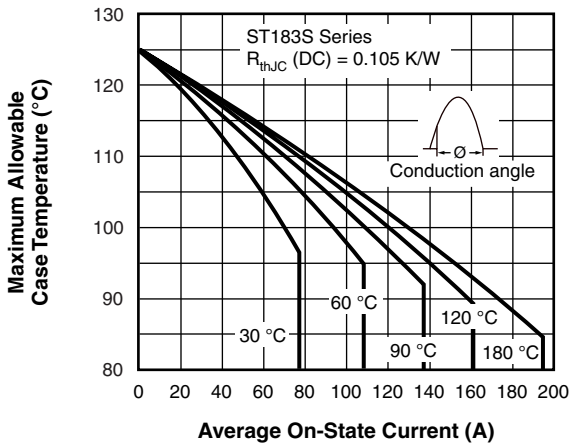

Fig. 1 - Current Ratings Characteristics

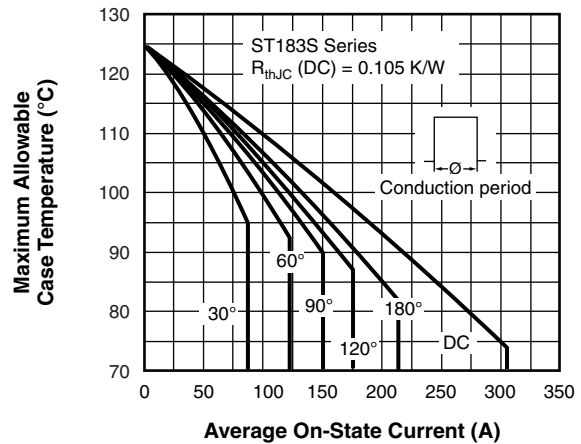

Fig. 2 - Current Ratings Characteristics

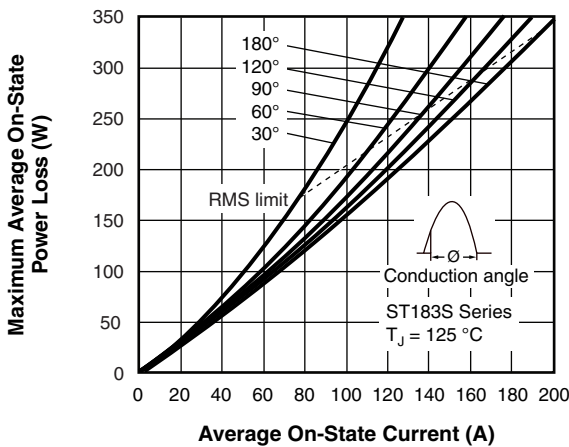

Fig. 3 - On-State Power Loss Characteristics

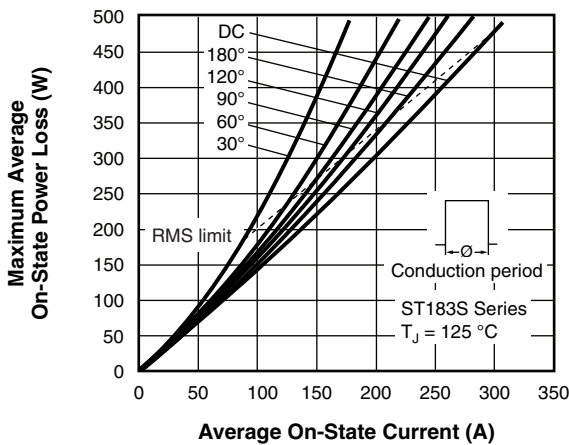
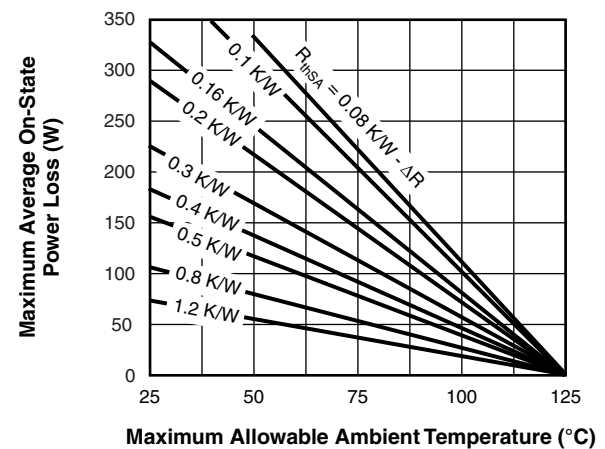
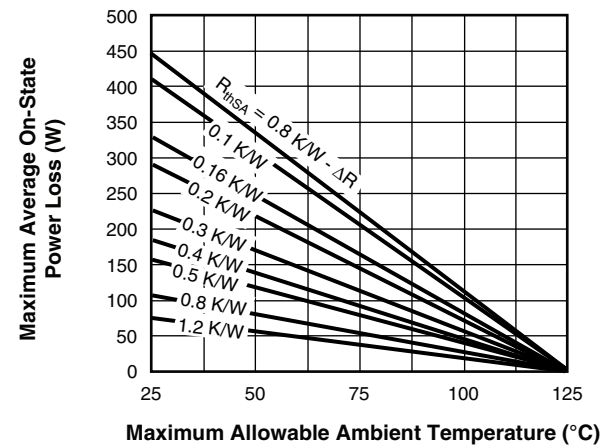

Fig. 4 - On-State Power Loss Characteristics



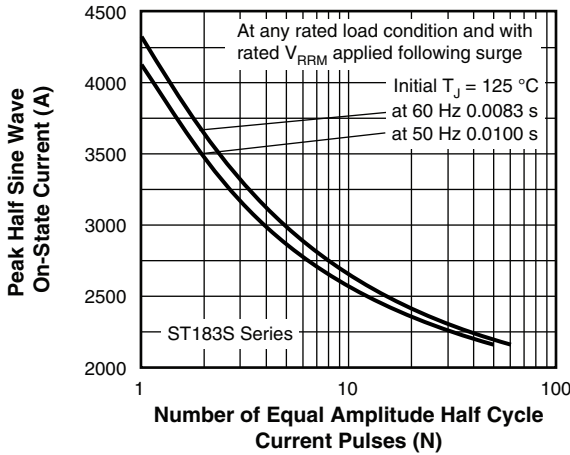

Fig. 5 - Maximum Non-Repetitive Surge Current

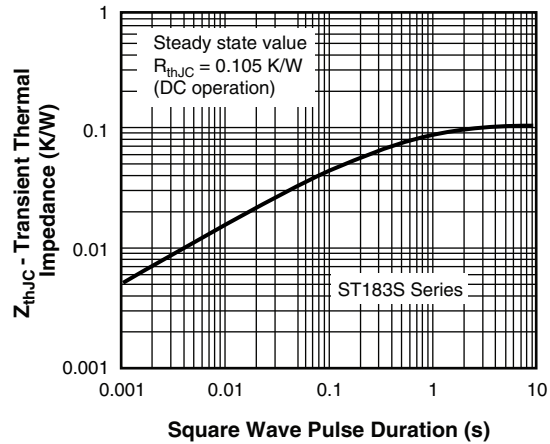

Fig. 8 - Thermal Impedance Z_{thJC} Characteristics

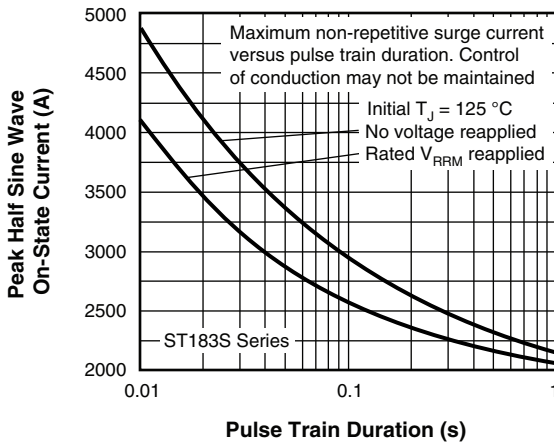

Fig. 6 - Maximum Non-Repetitive Surge Current

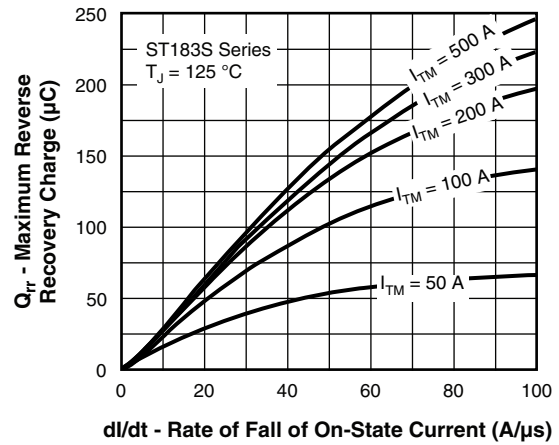

Fig. 9 - Reverse Recovered Charge Characteristics

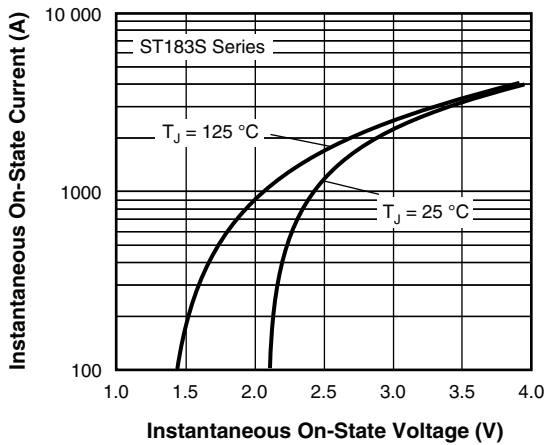

Fig. 7 - On-State Voltage Drop Characteristics

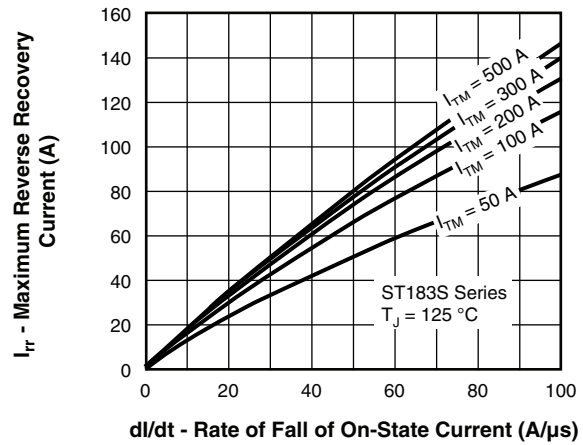

Fig. 10 - Reverse Recovery Current Characteristics

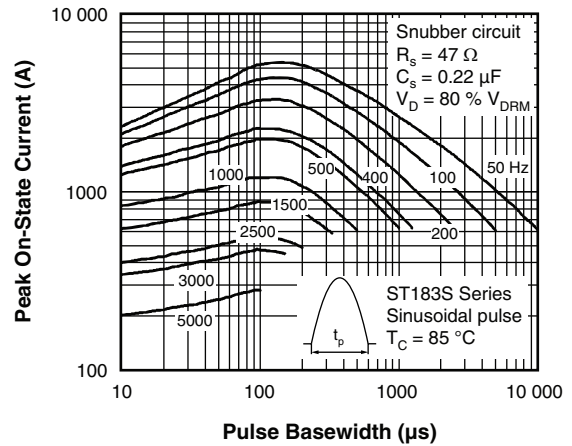
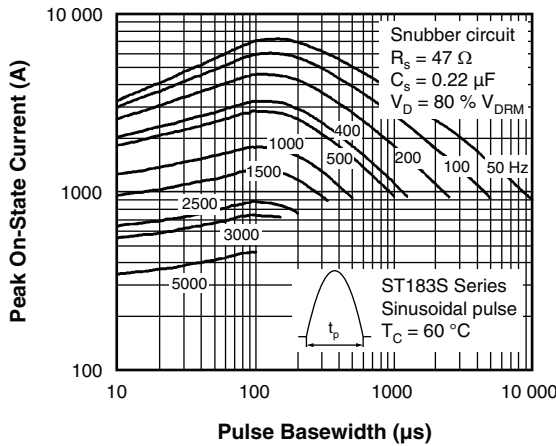

Fig. 11 - Frequency Characteristics

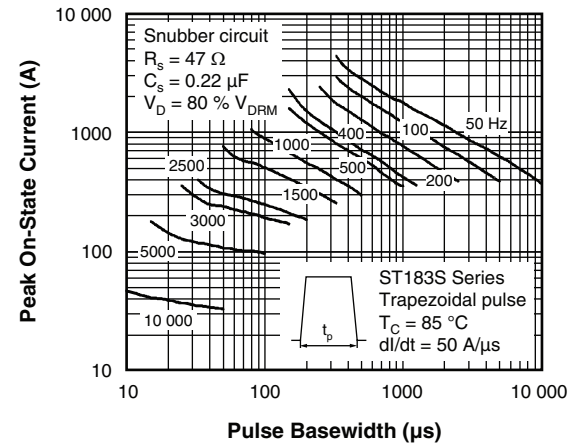
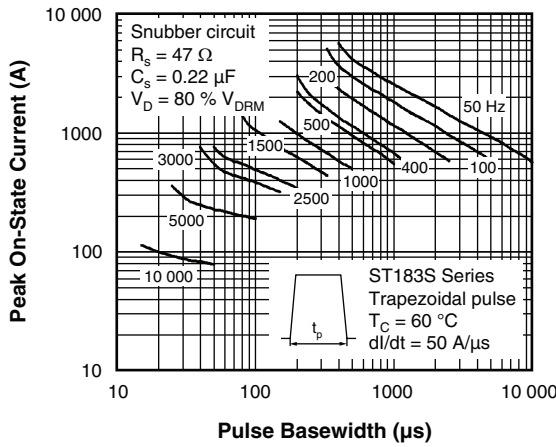

Fig. 12 - Frequency Characteristics

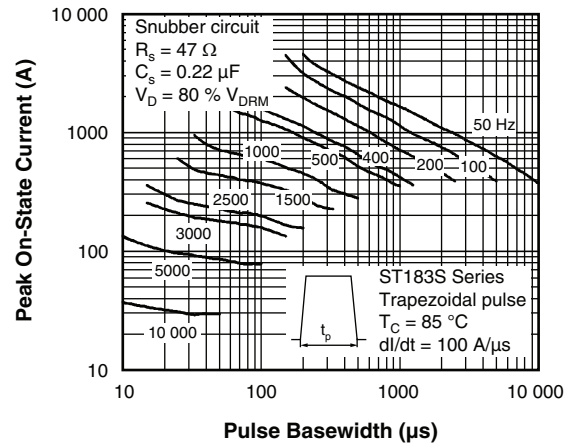
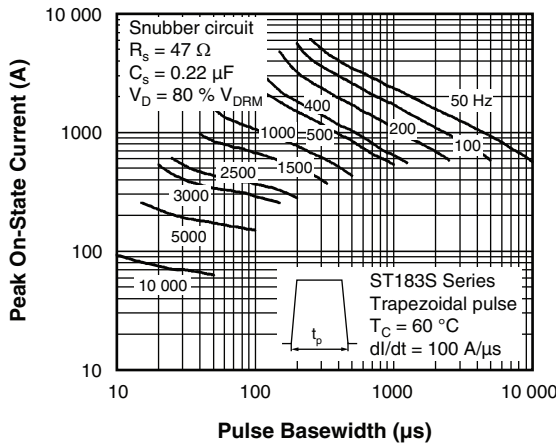

Fig. 13 - Frequency Characteristics

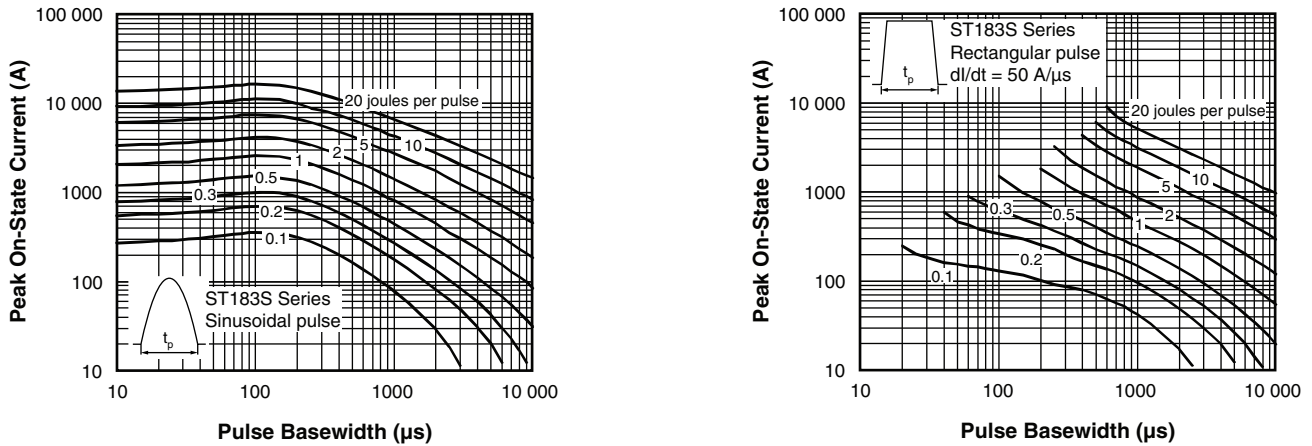

Fig. 14 - Maximum On-State Energy Power Loss Characteristics

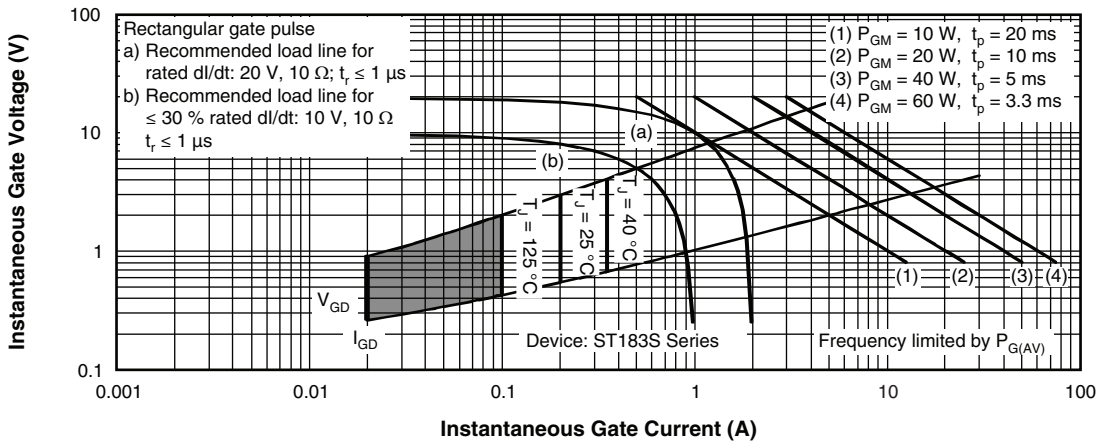
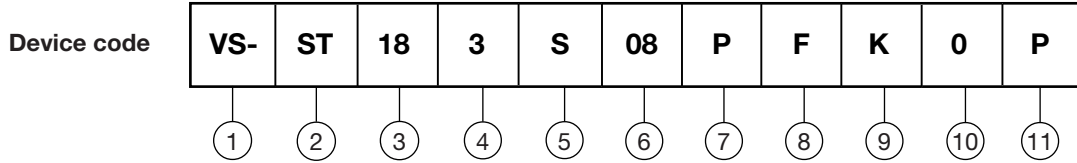

Fig. 15 - Gate Characteristics



ORDERING INFORMATION TABLE



- 1** - Vishay Semiconductors product
- 2** - Thyristor
- 3** - Essential part number
- 4** - 3 = fast turn-off
- 5** - S = compression bonding stud
- 6** - Voltage code x 100 = V_{RRM} (see Voltage Ratings table)
- 7** - P = Stud base 3/4" 16UNF-2A
- 8** - Reapplied dV/dt code (for t_q test condition)
- 9** - t_q code
- 10** - 0 = eyelet terminals
(gate and auxiliary cathode leads)
1 = fast-on terminals
(gate and auxiliary cathode leads)
- 11** - None = standard production
P = lead (Pb)-free

dV/dt - t_q combinations available		
	dV/dt (V/ μ s)	200
t_q (μ s)	15	FL
	20	FK

Note: For metric device M16 x 1.5 contact factory

LINKS TO RELATED DOCUMENTS	
Dimensions	www.vishay.com/doc?95077

TO-209AB (TO-93)

DIMENSIONS in millimeters (inches)

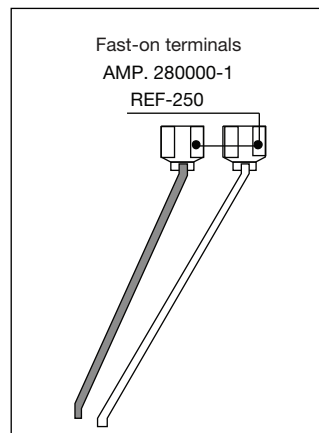
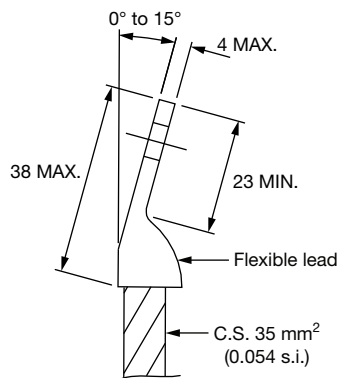
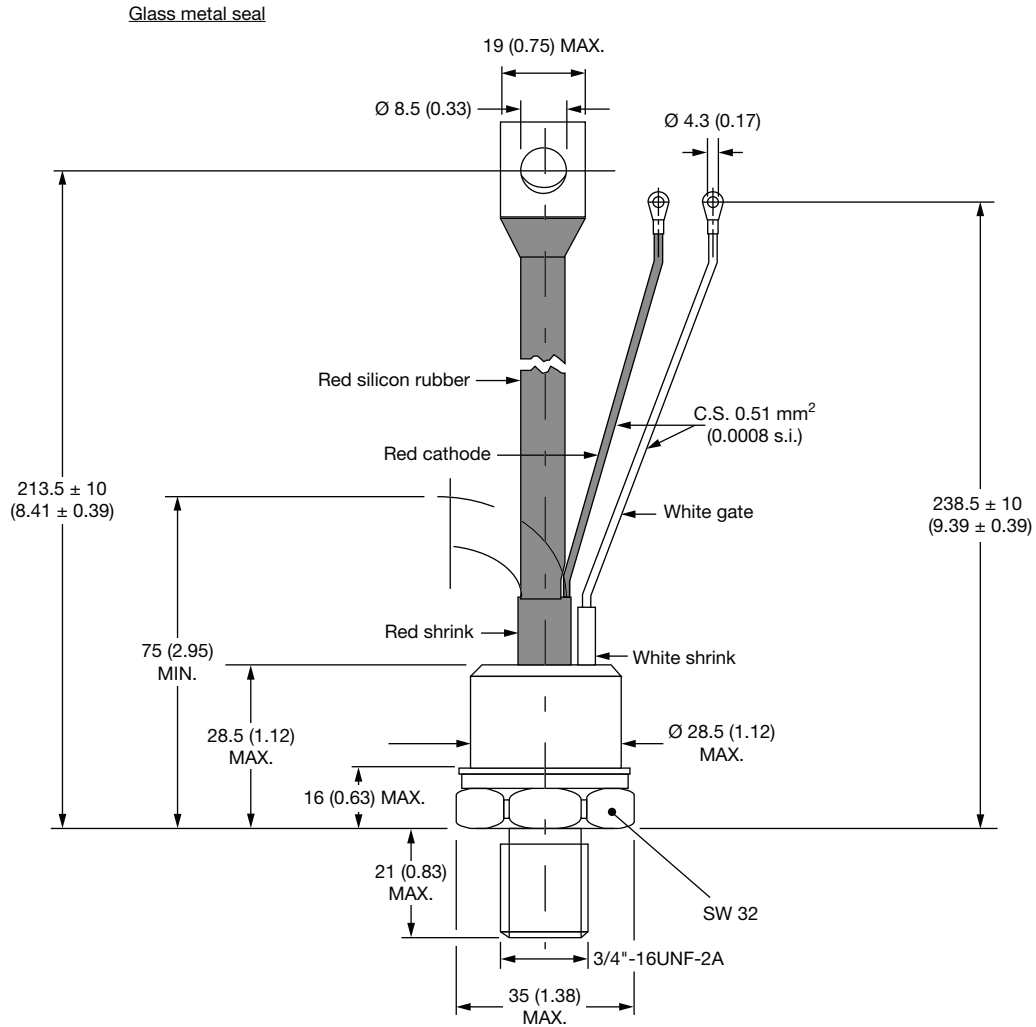



Disclaimer

ALL PRODUCT, PRODUCT SPECIFICATIONS AND DATA ARE SUBJECT TO CHANGE WITHOUT NOTICE TO IMPROVE RELIABILITY, FUNCTION OR DESIGN OR OTHERWISE.

Vishay Intertechnology, Inc., its affiliates, agents, and employees, and all persons acting on its or their behalf (collectively, "Vishay"), disclaim any and all liability for any errors, inaccuracies or incompleteness contained in any datasheet or in any other disclosure relating to any product.

Vishay makes no warranty, representation or guarantee regarding the suitability of the products for any particular purpose or the continuing production of any product. To the maximum extent permitted by applicable law, Vishay disclaims (i) any and all liability arising out of the application or use of any product, (ii) any and all liability, including without limitation special, consequential or incidental damages, and (iii) any and all implied warranties, including warranties of fitness for particular purpose, non-infringement and merchantability.

Statements regarding the suitability of products for certain types of applications are based on Vishay's knowledge of typical requirements that are often placed on Vishay products in generic applications. Such statements are not binding statements about the suitability of products for a particular application. It is the customer's responsibility to validate that a particular product with the properties described in the product specification is suitable for use in a particular application. Parameters provided in datasheets and / or specifications may vary in different applications and performance may vary over time. All operating parameters, including typical parameters, must be validated for each customer application by the customer's technical experts. Product specifications do not expand or otherwise modify Vishay's terms and conditions of purchase, including but not limited to the warranty expressed therein.

Except as expressly indicated in writing, Vishay products are not designed for use in medical, life-saving, or life-sustaining applications or for any other application in which the failure of the Vishay product could result in personal injury or death. Customers using or selling Vishay products not expressly indicated for use in such applications do so at their own risk. Please contact authorized Vishay personnel to obtain written terms and conditions regarding products designed for such applications.

No license, express or implied, by estoppel or otherwise, to any intellectual property rights is granted by this document or by any conduct of Vishay. Product names and markings noted herein may be trademarks of their respective owners.