

High Performance Schottky Rectifier, 3.5 A

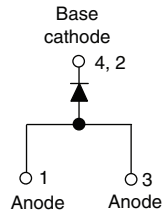

FEATURES

- Low forward voltage drop
- Guard ring for enhanced ruggedness and long term reliability
- Popular D-PAK outline
- Small foot print, surface mountable
- High frequency operation
- Meets MSL level 1, per J-STD-020, LF maximum peak of 260 °C
- Material categorization: for definitions of compliance please see www.vishay.com/doc?99912



RoHS
COMPLIANT
HALOGEN
FREE

DESCRIPTION

The VS-30WQ10FN-M3 surface mount Schottky rectifier has been designed for applications requiring low forward drop and small foot prints on PC board. Typical applications are in disk drives, switching power supplies, converters, freewheeling diodes, battery charging, and reverse battery protection.

| PRODUCT SUMMARY | |
|-----------------|----------------------|
| Package | TO-252AA (D-PAK) |
| $I_{F(AV)}$ | 3.5 A |
| V_R | 100 V |
| V_F at I_F | See Electrical table |
| I_{RM} | 4.9 mA at 125 °C |
| T_J max. | 150 °C |
| Diode variation | Single die |
| E_{AS} | 5 mJ |

| MAJOR RATINGS AND CHARACTERISTICS | | | |
|-----------------------------------|-------------------------------------|-------------|-------|
| SYMBOL | CHARACTERISTICS | VALUES | UNITS |
| $I_{F(AV)}$ | Rectangular waveform | 3.5 | A |
| V_{RRM} | | 100 | V |
| I_{FSM} | $t_p = 5 \mu s$ sine | 440 | A |
| V_F | $3 A_{pk}$, $T_J = 125 \text{ °C}$ | 0.63 | V |
| T_J | | -40 to +150 | °C |

| VOLTAGE RATINGS | | | |
|--------------------------------------|-----------|----------------|-------|
| PARAMETER | SYMBOL | VS-30WQ10FN-M3 | UNITS |
| Maximum DC reverse voltage | V_R | 100 | V |
| Maximum working peak reverse voltage | V_{RWM} | | |

| ABSOLUTE MAXIMUM RATINGS | | | | |
|--|-------------|---|--------|-------|
| PARAMETER | SYMBOL | TEST CONDITIONS | VALUES | UNITS |
| Maximum average forward current See fig. 5 | $I_{F(AV)}$ | 50 % duty cycle at $T_C = 135 \text{ °C}$, rectangular waveform | 3.5 | A |
| Maximum peak one cycle non-repetitive surge current See fig. 7 | I_{FSM} | 5 μs sine or 3 μs rect. pulse | 440 | |
| | | 10 ms sine or 6 ms rect. pulse | 70 | |
| Non-repetitive avalanche energy | E_{AS} | $T_J = 25 \text{ °C}$, $I_{AS} = 1 \text{ A}$, $L = 10 \text{ mH}$ | 5.0 | mJ |
| Repetitive avalanche current | I_{AR} | Current decaying linearly to zero in 1 μs Frequency limited by T_J maximum $V_A = 1.5 \times V_R$ typical | 0.5 | A |



| ELECTRICAL SPECIFICATIONS | | | | | |
|---|----------------|--|-----------------------------------|--------|------------|
| PARAMETER | SYMBOL | TEST CONDITIONS | | VALUES | UNITS |
| Maximum forward voltage drop See fig. 1 | $V_{FM}^{(1)}$ | 3 A | $T_J = 25\text{ }^\circ\text{C}$ | 0.81 | V |
| | | 6 A | | 0.96 | |
| | | 3 A | $T_J = 125\text{ }^\circ\text{C}$ | 0.63 | |
| | | 6 A | | 0.74 | |
| Maximum reverse leakage current See fig. 2 | $I_{RM}^{(1)}$ | $T_J = 25\text{ }^\circ\text{C}$ | $V_R = \text{Rated } V_R$ | 1 | mA |
| | | $T_J = 125\text{ }^\circ\text{C}$ | | 4.9 | |
| Threshold voltage | $V_{F(TO)}$ | $T_J = T_J \text{ maximum}$ | | 0.48 | V |
| Forward slope resistance | r_t | | | 30.89 | m Ω |
| Typical junction capacitance | C_T | $V_R = 5\text{ }V_{DC}$ (test signal range 100 kHz to 1 MHz), $25\text{ }^\circ\text{C}$ | | 92 | pF |
| Typical series inductance | L_S | Measured lead to lead 5 mm from package body | | 5.0 | nH |
| Maximum voltage rate of change | dV/dt | Rated V_R | | 10 000 | V/ μ s |

Note(1) Pulse width < 300 μ s, duty cycle < 2 %

| THERMAL - MECHANICAL SPECIFICATIONS | | | | | |
|--|----------------------|--|--|-------------|---------------------------|
| PARAMETER | SYMBOL | TEST CONDITIONS | | VALUES | UNITS |
| Maximum junction and storage temperature range | $T_J^{(1)}, T_{Stg}$ | | | -40 to +150 | $^\circ\text{C}$ |
| Maximum thermal resistance, junction to case | R_{thJC} | DC operation See fig. 4 | | 4.7 | $^\circ\text{C}/\text{W}$ |
| Approximate weight | | | | 0.3 | g |
| | | | | 0.01 | oz. |
| Marking device | | Case style D-PAK (similar to TO-252AA) | | 30WQ10FN | |

Note(1) $\frac{dP_{tot}}{dT_J} < \frac{1}{R_{thJA}}$ thermal runaway condition for a diode on its own heatsink

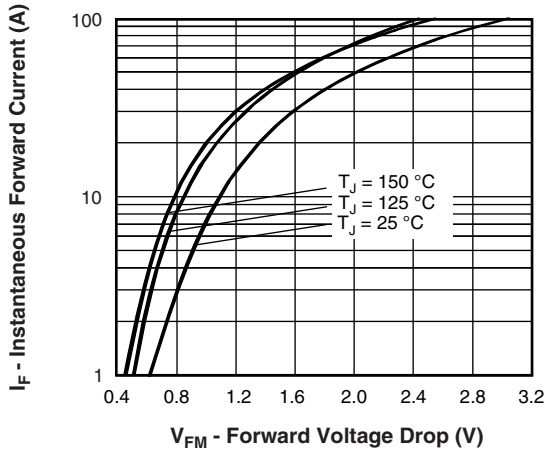

Fig. 1 - Maximum Forward Voltage Drop Characteristics

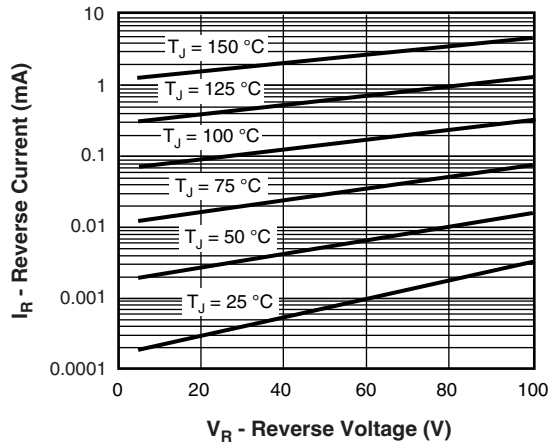

Fig. 2 - Typical Values of Reverse Current vs. Reverse Voltage

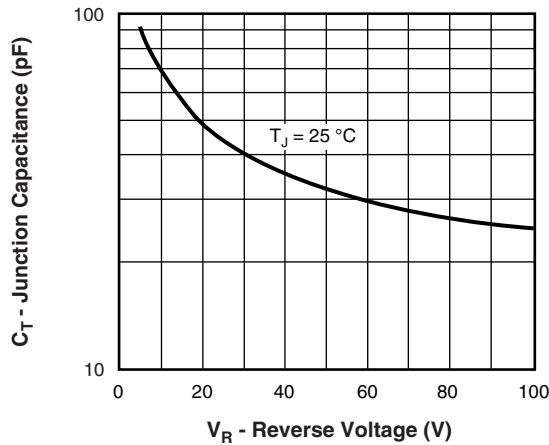

Fig. 3 - Typical Junction Capacitance vs. Reverse Voltage

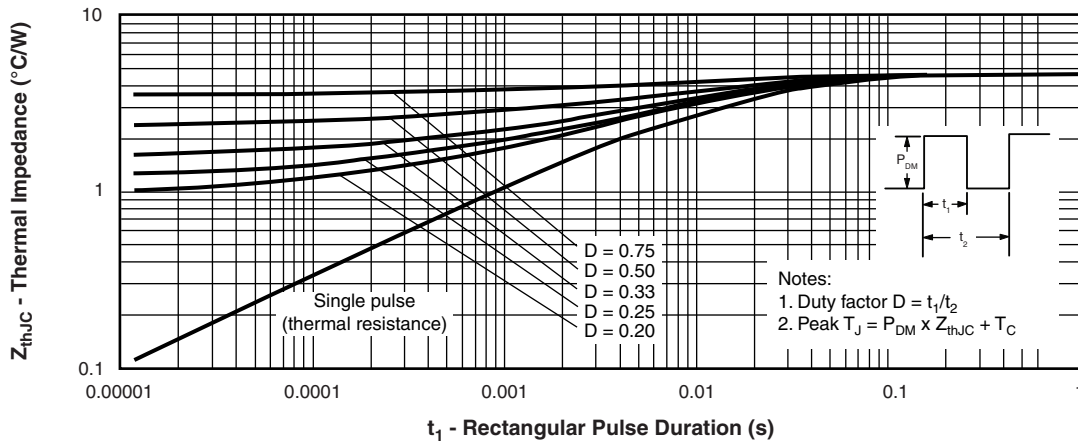

Fig. 4 - Maximum Thermal Impedance Z_{thJC} Characteristics

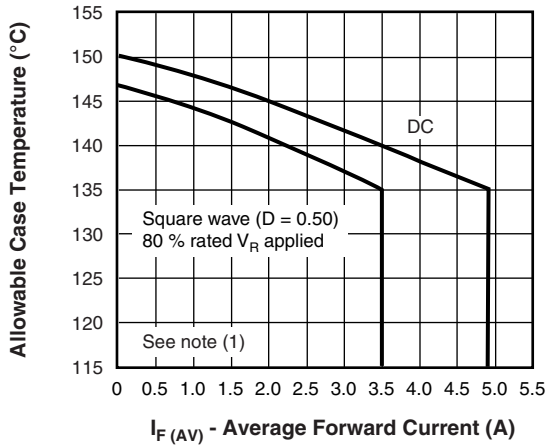

Fig. 5 - Maximum Allowable Case Temperature vs. Average Forward Current

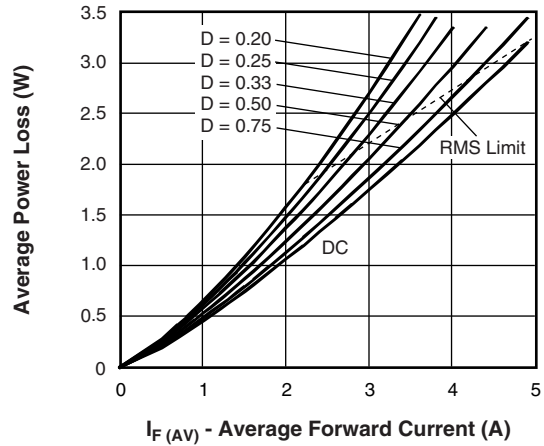

Fig. 6 - Forward Power Loss Characteristics

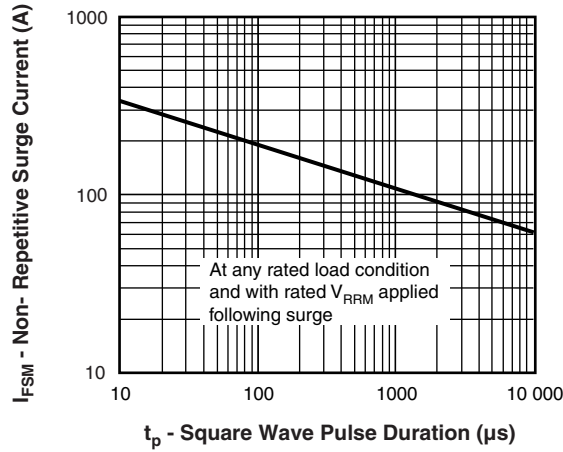

Fig. 7 - Maximum Non-Repetitive Surge Current

Note

- (1) Formula used: $T_C = T_J - (P_d + P_{dREV}) \times R_{thJC}$;
 P_d = forward power loss = $I_{F(AV)} \times V_{FM}$ at $(I_{F(AV)}/D)$ (see fig. 6);
 P_{dREV} = inverse power loss = $V_{R1} \times I_R (1 - D)$; I_R at $V_{R1} = 80\%$ rated V_R



ORDERING INFORMATION TABLE

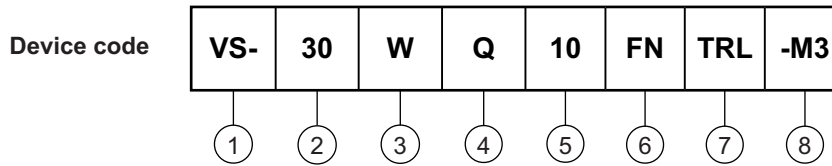

- 1** - Vishay Semiconductors product
- 2** - Current rating (3.5 A)
- 3** - Package identifier:
W = D-PAK
- 4** - Schottky "Q" series
- 5** - Voltage rating (10 = 100 V)
- 6** - FN = TO-252AA (D-PAK)
- 7** -
 - None = tube
 - TR = tape and reel
 - TRL = tape and reel (left oriented)
 - TRR = tape and reel (right oriented)
- 8** - Environmental digit:
-M3 = halogen-free, RoHS-compliant and terminations lead (Pb)-free

| ORDERING INFORMATION (Example) | | | |
|--------------------------------|------------------|------------------------|-------------------------|
| PREFERRED P/N | QUANTITY PER T/R | MINIMUM ORDER QUANTITY | PACKAGING DESCRIPTION |
| VS-30WQ10FN-M3 | 75 | 3000 | Antistatic plastic tube |
| VS-30WQ10FNTR-M3 | 2000 | 2000 | 13" diameter reel |
| VS-30WQ10FNTRL-M3 | 3000 | 3000 | 13" diameter reel |
| VS-30WQ10FNTRR-M3 | 3000 | 3000 | 13" diameter reel |

| LINKS TO RELATED DOCUMENTS | |
|----------------------------|--|
| Dimensions | www.vishay.com/doc?95627 |
| Part marking information | www.vishay.com/doc?95176 |
| Packaging information | www.vishay.com/doc?95033 |
| SPIICE model | www.vishay.com/doc?95650 |

D-PAK (TO-252AA) "M"

DIMENSIONS in millimeters and inches

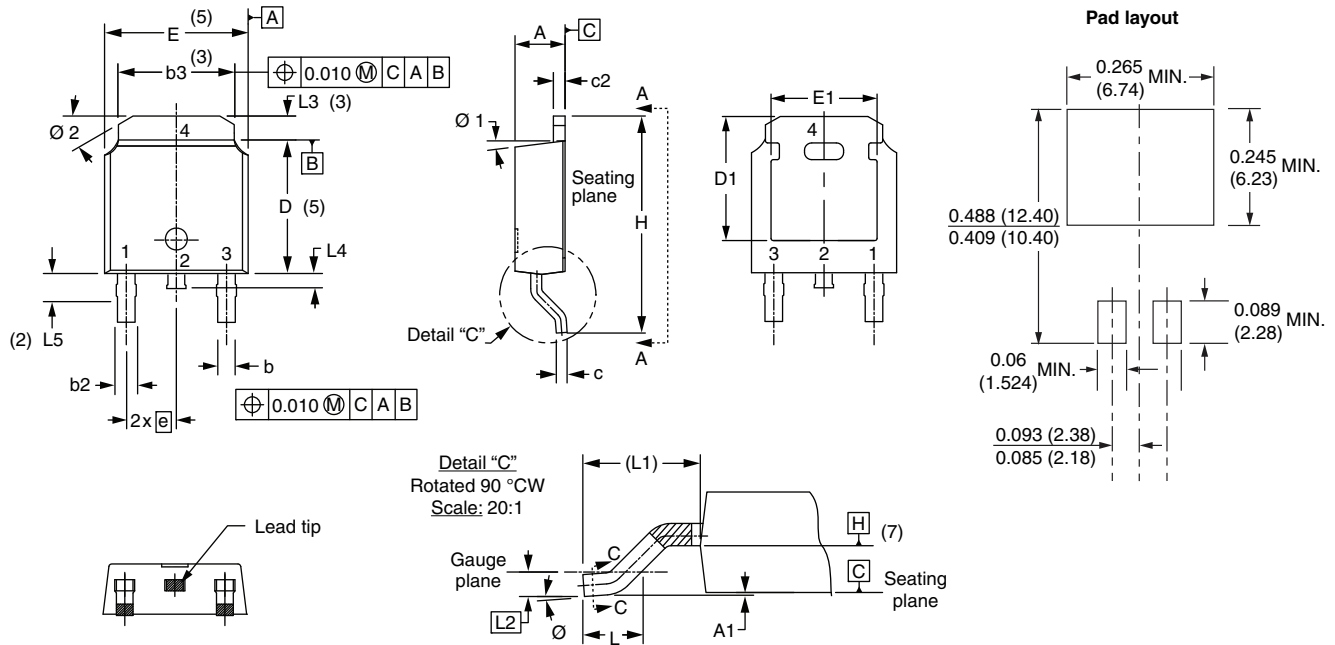

| SYMBOL | MILLIMETERS | | INCHES | | NOTES | SYMBOL | MILLIMETERS | | INCHES | | NOTES |
|--------|-------------|------|--------|-------|-------|--------|-------------|-------|------------|-------|-------|
| | MIN. | MAX. | MIN. | MAX. | | | MIN. | MAX. | MIN. | MAX. | |
| A | 2.18 | 2.39 | 0.086 | 0.094 | | e | 2.29 BSC | | 0.090 BSC | | |
| A1 | - | 0.13 | - | 0.005 | | H | 9.40 | 10.41 | 0.370 | 0.410 | |
| b | 0.64 | 0.89 | 0.025 | 0.035 | | L | 1.40 | 1.78 | 0.055 | 0.070 | |
| b2 | 0.76 | 1.14 | 0.030 | 0.045 | | L1 | 2.74 BSC | | 0.108 REF. | | |
| b3 | 4.95 | 5.46 | 0.195 | 0.215 | 3 | L2 | 0.51 BSC | | 0.020 BSC | | |
| c | 0.46 | 0.61 | 0.018 | 0.024 | | L3 | 0.89 | 1.27 | 0.035 | 0.050 | 3 |
| c2 | 0.46 | 0.89 | 0.018 | 0.035 | | L4 | - | 1.02 | - | 0.040 | |
| D | 5.97 | 6.22 | 0.235 | 0.245 | 5 | L5 | 1.14 | 1.52 | 0.045 | 0.060 | 2 |
| D1 | 5.21 | - | 0.205 | - | 3 | Ø | 0° | 10° | 0° | 10° | |
| E | 6.35 | 6.73 | 0.250 | 0.265 | 5 | Ø1 | 0° | 15° | 0° | 15° | |
| E1 | 4.32 | - | 0.170 | - | 3 | Ø2 | 25° | 35° | 25° | 35° | |

Notes

- (1) Dimensioning and tolerancing as per ASME Y14.5M-1994
- (2) Lead dimension uncontrolled in L5
- (3) Dimension D1, E1, L3 and b3 establish a minimum mounting surface for thermal pad
- (4) Section C - C dimension apply to the flat section of the lead between 0.13 and 0.25 mm (0.005 and 0.10") from the lead tip
- (5) Dimension D, and E do not include mold flash. Mold flash shall not exceed 0.127 mm (0.005") per side. These dimensions are measured at the outermost extremes of the plastic body
- (6) Dimension b1 and c1 applied to base metal only
- (7) Datum A and B to be determined at datum plane H
- (8) Outline conforms to JEDEC® outline TO-252AA



Disclaimer

ALL PRODUCT, PRODUCT SPECIFICATIONS AND DATA ARE SUBJECT TO CHANGE WITHOUT NOTICE TO IMPROVE RELIABILITY, FUNCTION OR DESIGN OR OTHERWISE.

Vishay Intertechnology, Inc., its affiliates, agents, and employees, and all persons acting on its or their behalf (collectively, "Vishay"), disclaim any and all liability for any errors, inaccuracies or incompleteness contained in any datasheet or in any other disclosure relating to any product.

Vishay makes no warranty, representation or guarantee regarding the suitability of the products for any particular purpose or the continuing production of any product. To the maximum extent permitted by applicable law, Vishay disclaims (i) any and all liability arising out of the application or use of any product, (ii) any and all liability, including without limitation special, consequential or incidental damages, and (iii) any and all implied warranties, including warranties of fitness for particular purpose, non-infringement and merchantability.

Statements regarding the suitability of products for certain types of applications are based on Vishay's knowledge of typical requirements that are often placed on Vishay products in generic applications. Such statements are not binding statements about the suitability of products for a particular application. It is the customer's responsibility to validate that a particular product with the properties described in the product specification is suitable for use in a particular application. Parameters provided in datasheets and / or specifications may vary in different applications and performance may vary over time. All operating parameters, including typical parameters, must be validated for each customer application by the customer's technical experts. Product specifications do not expand or otherwise modify Vishay's terms and conditions of purchase, including but not limited to the warranty expressed therein.

Except as expressly indicated in writing, Vishay products are not designed for use in medical, life-saving, or life-sustaining applications or for any other application in which the failure of the Vishay product could result in personal injury or death. Customers using or selling Vishay products not expressly indicated for use in such applications do so at their own risk. Please contact authorized Vishay personnel to obtain written terms and conditions regarding products designed for such applications.

No license, express or implied, by estoppel or otherwise, to any intellectual property rights is granted by this document or by any conduct of Vishay. Product names and markings noted herein may be trademarks of their respective owners.