



Small Signal Schottky Diodes



DESIGN SUPPORT TOOLS click logo to get started



MECHANICAL DATA

Case: MicroMELF

Weight: approx. 12 mg

Cathode band color: black

Packaging codes/options:

TR3/10K per 13" reel (8 mm tape), 10K/box

TR/2.5K per 7" reel (8 mm tape), 12.5K/box

FEATURES

- Integrated protection ring against static discharge
- Low capacitance
- Low leakage current
- Low forward voltage drop
- AEC-Q101 qualified
- Material categorization: for definitions of compliance please see www.vishay.com/doc?99912



RoHS
COMPLIANT
HALOGEN
FREE

APPLICATIONS

- IHF-detector
- Protection circuit
- Small battery charger
- AC/DC / DC/DC converter for notebooks

| PARTS TABLE | | | | |
|-------------|----------------------|---------------------------|-----------------------|---------------|
| PART | TYPE DIFFERENTIATION | ORDERING CODE | CIRCUIT CONFIGURATION | REMARKS |
| MCL103A | $V_R = 40\text{ V}$ | MCL103A-TR3 or MCL103A-TR | Single | Tape and reel |
| MCL103B | $V_R = 30\text{ V}$ | MCL103B-TR3 or MCL103B-TR | Single | Tape and reel |
| MCL103C | $V_R = 20\text{ V}$ | MCL103C-TR3 or MCL103C-TR | Single | Tape and reel |

| ABSOLUTE MAXIMUM RATINGS ($T_{amb} = 25\text{ }^\circ\text{C}$, unless otherwise specified) | | | | | |
|---|---|---------|-----------|-------|------|
| PARAMETER | TEST CONDITION | PART | SYMBOL | VALUE | UNIT |
| Reverse voltage | | MCL103A | V_R | 40 | V |
| | | MCL103B | V_R | 30 | V |
| | | MCL103C | V_R | 20 | V |
| Forward continuous current | | | I_F | 200 | mA |
| Peak forward surge current | $t_p = 300\text{ }\mu\text{s}$, square pulse | | I_{FSM} | 15 | A |
| Power dissipation | | | P_{tot} | 400 | mW |

| THERMAL CHARACTERISTICS ($T_{amb} = 25\text{ }^\circ\text{C}$, unless otherwise specified) | | | | |
|--|---------------------------------------|------------|-------------|------------------|
| PARAMETER | TEST CONDITION | SYMBOL | VALUE | UNIT |
| Thermal resistance junction to ambient air | On PC board 50 mm x 50 mm x 1.6 mm | R_{thJA} | 250 | K/W |
| Junction temperature | | T_j | 125 | $^\circ\text{C}$ |
| Storage temperature range | | T_{stg} | -65 to +150 | $^\circ\text{C}$ |



| ELECTRICAL CHARACTERISTICS ($T_{amb} = 25\text{ }^{\circ}\text{C}$, unless otherwise specified) | | | | | | | |
|---|---|---------|------------|------|------|------|---------------|
| PARAMETER | TEST CONDITION | SYMBOL | SYMBOL | MIN. | TYP. | MAX. | UNIT |
| Reverse breakdown voltage | $I_R = 10\text{ }\mu\text{A}$ | MCL103A | $V_{(BR)}$ | 40 | | | V |
| | | MCL103B | $V_{(BR)}$ | 30 | | | V |
| | | MCL103C | $V_{(BR)}$ | 20 | | | V |
| Leakage current | $V_R = 30\text{ V}$ | MCL103A | I_R | | | 5 | μA |
| | $V_R = 20\text{ V}$ | MCL103B | I_R | | | 5 | μA |
| | $V_R = 10\text{ V}$ | MCL103C | I_R | | | 5 | μA |
| Forward voltage drop | $I_F = 20\text{ mA}$ | | V_F | | | 370 | mV |
| | $I_F = 200\text{ mA}$ | | V_F | | | 600 | mV |
| Diode capacitance | $V_R = 0\text{ V}$, $f = 1\text{ MHz}$ | | C_D | | 50 | | pF |
| Reverse recovery time | $I_F = I_R = 50\text{ mA}$ to 200 mA , recovery to $0.1 I_R$ | | t_{rr} | | 10 | | ns |

TYPICAL CHARACTERISTICS ($T_{amb} = 25\text{ }^{\circ}\text{C}$, unless otherwise specified)

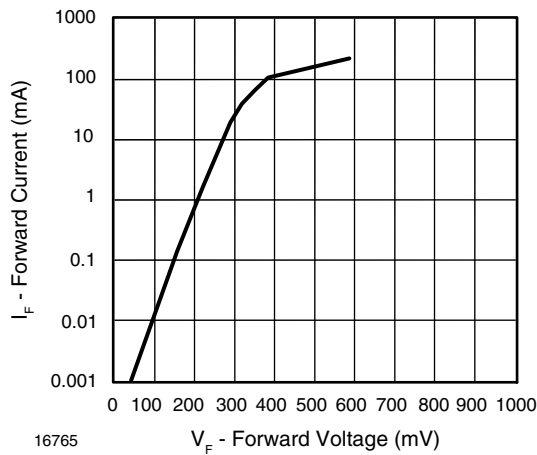

Fig. 1 - Forward Current vs. Forward Voltage

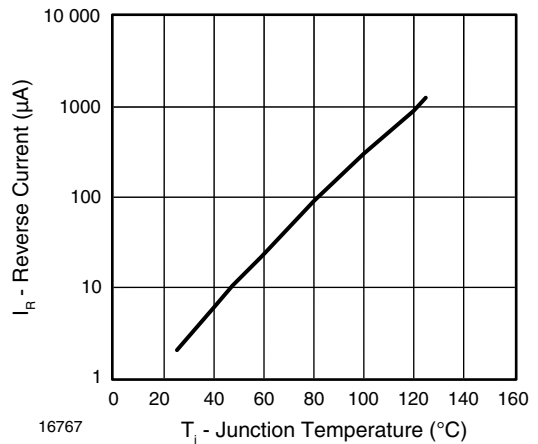

Fig. 3 - Reverse Current vs. Junction Temperature

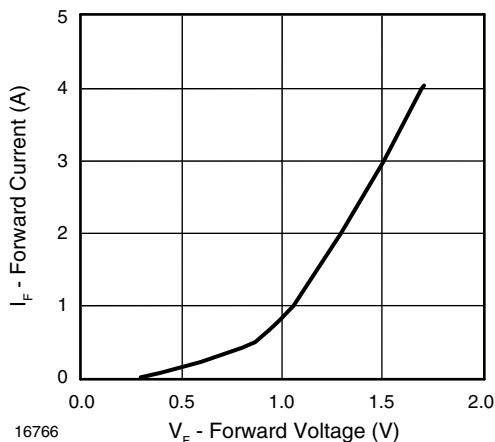

Fig. 2 - Forward Current vs. Forward Voltage

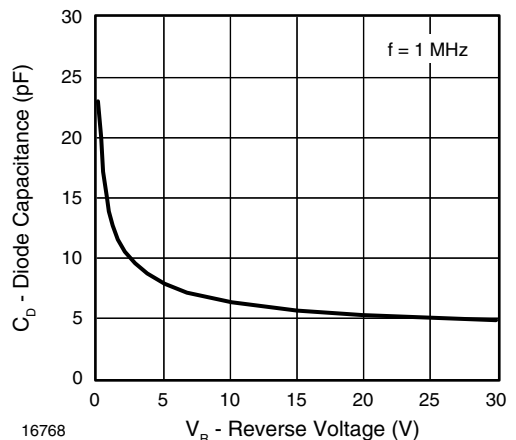

Fig. 4 - Diode Capacitance vs. Reverse Voltage

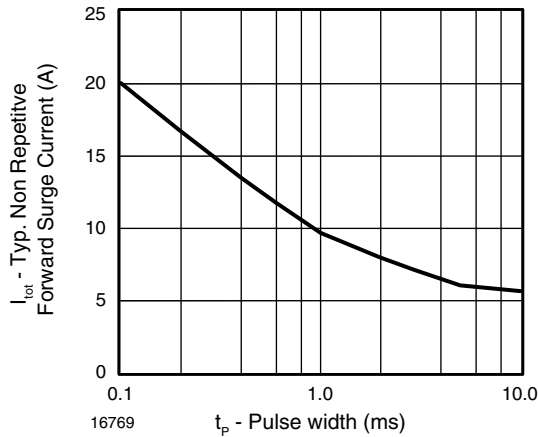
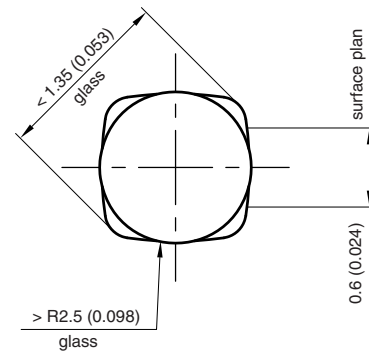
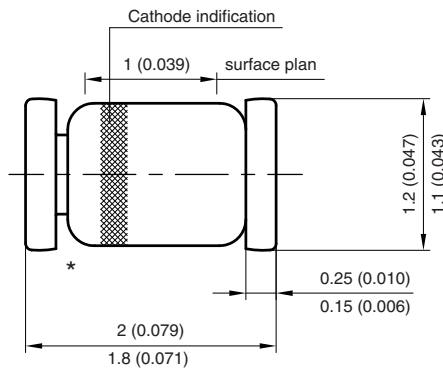

Fig. 5 - Typical Non-Repetitive Forward Surge Current vs. Pulse Width

PACKAGE DIMENSIONS in millimeters (inches): **MicroMELF**



* The gap between plug and glass can be either on cathode or anode side

Foot print recommendation:

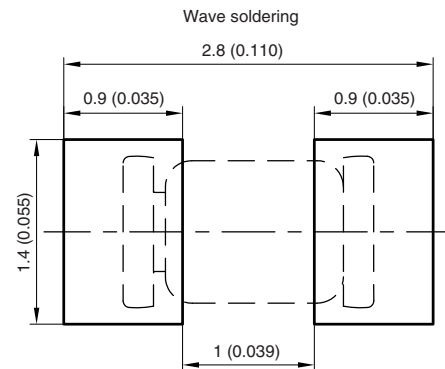
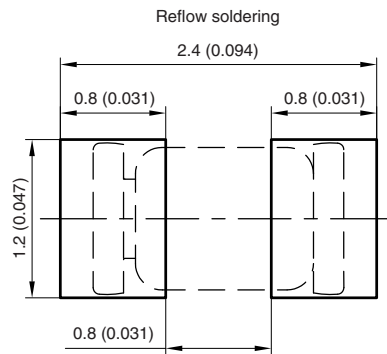

Created - Date: 26.July.1996
 Rev. 13 - Date: 07.June.2006
 Document no.:6.560-5007.01-4
 96 12072



Disclaimer

ALL PRODUCT, PRODUCT SPECIFICATIONS AND DATA ARE SUBJECT TO CHANGE WITHOUT NOTICE TO IMPROVE RELIABILITY, FUNCTION OR DESIGN OR OTHERWISE.

Vishay Intertechnology, Inc., its affiliates, agents, and employees, and all persons acting on its or their behalf (collectively, "Vishay"), disclaim any and all liability for any errors, inaccuracies or incompleteness contained in any datasheet or in any other disclosure relating to any product.

Vishay makes no warranty, representation or guarantee regarding the suitability of the products for any particular purpose or the continuing production of any product. To the maximum extent permitted by applicable law, Vishay disclaims (i) any and all liability arising out of the application or use of any product, (ii) any and all liability, including without limitation special, consequential or incidental damages, and (iii) any and all implied warranties, including warranties of fitness for particular purpose, non-infringement and merchantability.

Statements regarding the suitability of products for certain types of applications are based on Vishay's knowledge of typical requirements that are often placed on Vishay products in generic applications. Such statements are not binding statements about the suitability of products for a particular application. It is the customer's responsibility to validate that a particular product with the properties described in the product specification is suitable for use in a particular application. Parameters provided in datasheets and / or specifications may vary in different applications and performance may vary over time. All operating parameters, including typical parameters, must be validated for each customer application by the customer's technical experts. Product specifications do not expand or otherwise modify Vishay's terms and conditions of purchase, including but not limited to the warranty expressed therein.

Except as expressly indicated in writing, Vishay products are not designed for use in medical, life-saving, or life-sustaining applications or for any other application in which the failure of the Vishay product could result in personal injury or death. Customers using or selling Vishay products not expressly indicated for use in such applications do so at their own risk. Please contact authorized Vishay personnel to obtain written terms and conditions regarding products designed for such applications.

No license, express or implied, by estoppel or otherwise, to any intellectual property rights is granted by this document or by any conduct of Vishay. Product names and markings noted herein may be trademarks of their respective owners.