

$I_{F(AV)} = 7\text{Amp}$
 $V_R = 30\text{V}$

Major Ratings and Characteristics

Characteristics	Values	Units
$I_{F(AV)}$ Rectangular waveform	7	A
V_{RRM}	30	V
I_{FSM} @ tp = 5 μ s sine	535	A
V_F @ 3Apk, $T_J = 125^\circ\text{C}$ (per leg)	0.35	V
T_J range	-40 to 150	$^\circ\text{C}$

Description/ Features

The 6CWQ03FN surface mount, center tap, Schottky rectifier series has been designed for applications requiring low forward drop and small foot prints on PC board. Typical applications are in disk drives, switching power supplies, converters, free-wheeling diodes, battery charging, and reverse battery protection.

- Popular D-PAK outline
- Center tap configuration
- Small foot print, surface mountable
- Low forward voltage drop
- High frequency operation
- Guard ring for enhanced ruggedness and long term reliability

Case Styles



D-PAK (TO-252AA)

6CWQ03FN

Bulletin PD-20560 rev. H 05/06

International
 Rectifier

Voltage Ratings

Part number	6CWQ03FN
V_R Max. DC Reverse Voltage (V)	30
V_{RWM} Max. Working Peak Reverse Voltage (V)	

Absolute Maximum Ratings

Parameters	6CWQ...	Units	Conditions
$I_{F(AV)}$ Max. Average Forward (Per Leg) Current * See Fig. 5 (Per Device)	3.5	A	50% duty cycle @ $T_C = 134^\circ\text{C}$, rectangular wave form
	7		
I_{FSM} Max. Peak One Cycle Non-Repetitive Surge Current (Per Leg) * See Fig. 7	535	A	5 μs Sine or 3 μs Rect. pulse
	90		10ms Sine or 6ms Rect. pulse
E_{AS} Non-Repet. Avalan. Energy (Per Leg)	8	mJ	$T_J = 25^\circ\text{C}$, $I_{AS} = 2$ Amps, $L = 4$ mH
I_{AR} Repetitive Avalanche Current (Per Leg)	1.0	A	Current decaying linearly to zero in 1 μsec Frequency limited by T_J max. $V_A = 1.5 \times V_R$ typical

Electrical Specifications

Parameters	6CWQ...	Units	Conditions
V_{FM} Max. Forward Voltage Drop (Per Leg) * See Fig. 1 (1)	0.45	V	@ 3A
	0.52	V	@ 6A
	0.35	V	@ 3A
	0.46	V	@ 6A
I_{RM} Max. Reverse Leakage Current (Per Leg) * See Fig. 2 (1)	2	mA	$T_J = 25^\circ\text{C}$
	50	mA	$T_J = 125^\circ\text{C}$
$V_{F(TO)}$ Threshold Voltage	0.22	V	$T_J = T_J$ max.
r_t Forward Slope Resistance	32.86	m Ω	
C_T Typ. Junction Capacitance (Per Leg)	290	pF	$V_R = 5V_{DC}$ (test signal range 100Khz to 1Mhz) 25°C
L_S Typical Series Inductance (Per Leg)	5.0	nH	Measured lead to lead 5mm from package body
dv/dt Max. Voltage Rate of Change	10000	V/ μs	(Rated V_R)

(1) Pulse Width < 300 μs , Duty Cycle <2%

Thermal-Mechanical Specifications

Parameters	6CWQ...	Units	Conditions
T_J Max. Junction Temperature Range (*)	-40 to 150	$^\circ\text{C}$	
T_{stg} Max. Storage Temperature Range	-40 to 150	$^\circ\text{C}$	
R_{thJC} Max. Thermal Resistance (Per Leg) Junction to Case (Per Device)	4.70	$^\circ\text{C}/\text{W}$	DC operation * See Fig. 4
	2.35		
wt Approximate Weight	0.3 (0.01)	g (oz.)	
Case Style	D-Pak		Similar to TO-252AA
Marking Device	6CWQ03FN		

(*) $\frac{dP_{tot}}{dT_J} < \frac{1}{R_{th(j-a)}}$ thermal runaway condition for a diode on its own heatsink

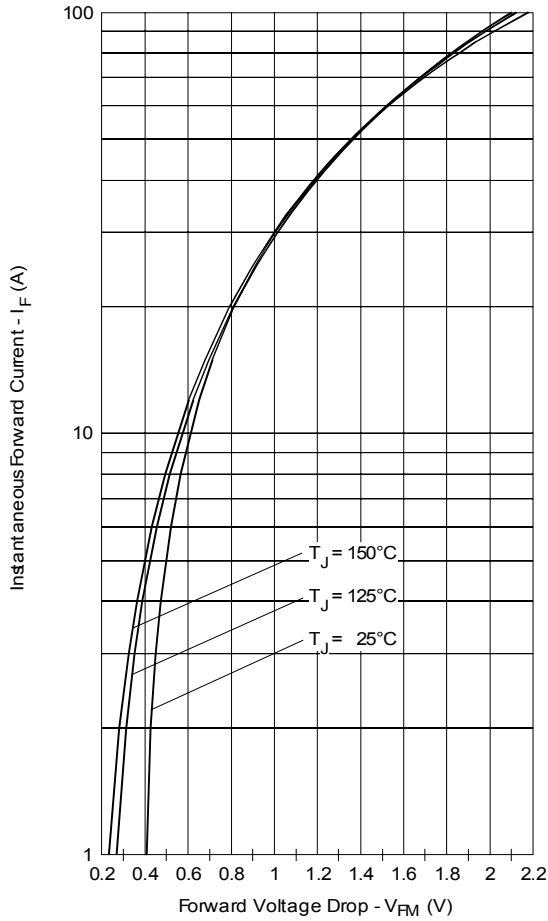

Fig. 1 - Max. Forward Voltage Drop Characteristics (Per Leg)

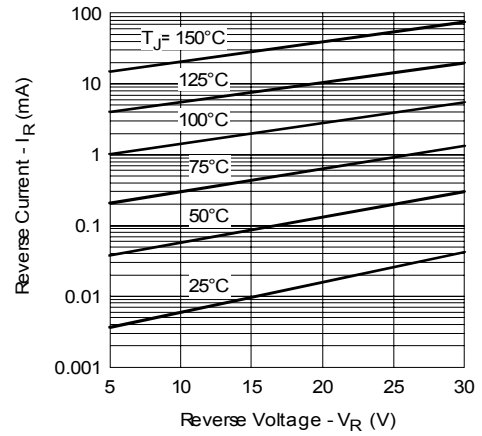

Fig. 2 - Typical Values Of Reverse Current Vs. Reverse Voltage (Per Leg)

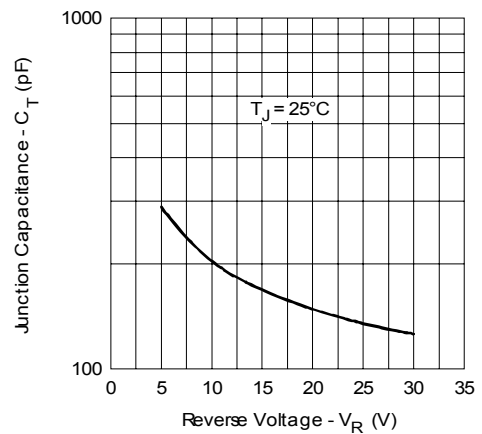

Fig. 3 - Typical Junction Capacitance Vs. Reverse Voltage (Per Leg)

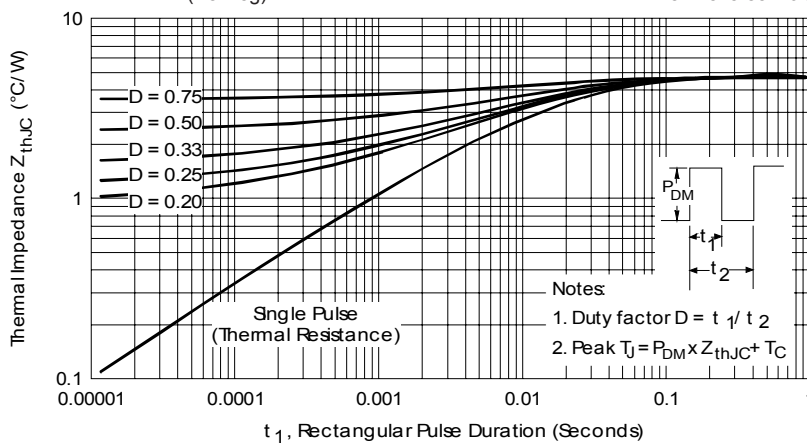

Fig. 4 - Max. Thermal Impedance Z_{thJC} Characteristics (Per Leg)

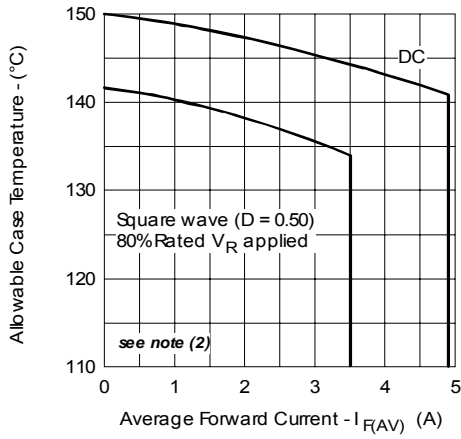

Fig. 5 - Max. Allowable Case Temperature Vs. Average Forward Current (Per Leg)

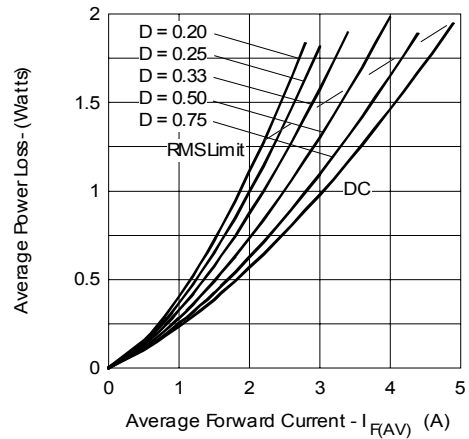

Fig. 6 - Forward Power Loss Characteristics (Per Leg)

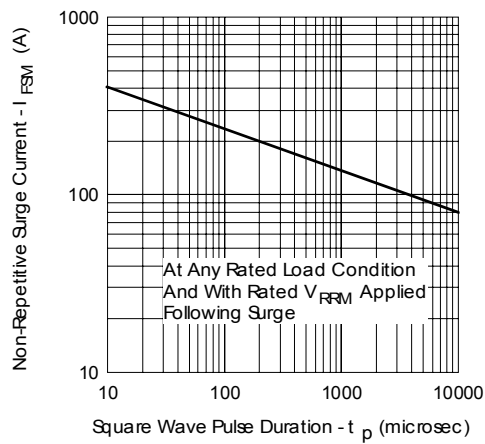

Fig. 7 - Max. Non-Repetitive Surge Current (Per Leg)

- (2) Formula used: $T_C = T_J - (Pd + Pd_{REV}) \times R_{thJC}$;
 $Pd = \text{Forward Power Loss} = I_{F(AV)} \times V_{FM} @ (I_{F(AV)} / D)$ (see Fig. 6);
 $Pd_{REV} = \text{Inverse Power Loss} = V_{R1} \times I_R (1 - D)$; $I_R @ V_{R1} = 80\% \text{ rated } V_R$

Outline Table

NOTES:
 1- DIMENSIONING AND TOLERANCING PER ASME Y14.5M-1994
 2- DIMENSION ARE SHOWN IN INCHES [MILLIMETERS]
 3- LEAD DIMENSION UNCONTROLLED IN IS.
 4- DIMENSION D1, E1, L3 & R3 ESTABLISH A MINIMUM MOUNTING SURFACE FOR THERMAL PAD.
 5- SECTION C-C DIMENSIONS APPLY TO THE FLAT SECTION OF THE LEAD BETWEEN .005 AND 0.10 [0.127 AND 0.254] FROM THE LEAD TIP.
 6- DIMENSION D & E DO NOT INCLUDE MOLD FLASH. MOLD FLASH SHALL NOT EXCEED .008 [0.127] PER SIDE. THESE DIMENSIONS ARE MEASURED AT THE OUTMOST EXTREMES OF THE PLASTIC BODY.
 7- DIMENSION S1 & S2 APPLIED TO BASE METAL ONLY.
 8- DATUM A & B TO BE DETERMINED AT DATUM PLANE X.
 9- OUTLINE CONFORMS TO JEDEC OUTLINE TO-252AA.

DIMENSION	MILLIMETERS		INCHES		TOLERANCE
	MIN.	MAX.	MIN.	MAX.	
A	2.18	2.29	.086	.094	
A1	-	0.15	-	.006	
b	0.84	0.89	.033	.035	
b1	0.60	0.70	.024	.028	7
b2	0.78	1.14	.030	.045	
b3	4.95	5.46	.195	.215	4
e	0.46	0.61	.018	.024	7
e1	0.41	0.56	.016	.022	
e2	0.48	0.89	.019	.035	
D	5.97	6.22	.235	.245	6
D1	5.21	-	.205	-	4
E	6.35	6.73	.250	.265	6
E1	4.32	-	.170	-	4
e	2.29 BSC	-	.090 BSC	-	
H	9.40	10.41	.370	.410	
L	1.40	1.78	.055	.070	
L1	2.74 BSC	-	.108 BSC	-	
L2	0.31 BSC	-	.012 BSC	-	
L3	0.99	1.27	.039	.050	4
L4	-	1.02	-	.040	
L5	1.14	1.52	.045	.060	
L6	0'	10'	0'	10'	3
W1	0'	15'	0'	15'	
W2	25'	35'	25'	35'	

LEAD ASSIGNMENTS
 1- GATE
 2- DRAIN
 3- SOURCE
 4- DRAIN

JEDEC SYMBOLS
 1- GATE
 2- COLLECTOR
 3- EMITTER
 4- COLLECTOR

Modified JEDEC outline TO-252AA
 Dimensions in millimeters and (inches)

Part Marking Information

EXAMPLE: THIS IS A 6CWQ03FN
 LOT CODE 8024
 ASSEMBLED ON WW 02, 2000

INTERNATIONAL
 RECTIFIER
 LOGO

ASSEMBLY
 LOT CODE

PART NUMBER

DATE CODE
 YEAR 0 = 2000
 WEEK 02
 X = SITE ID

Tape & Reel Information

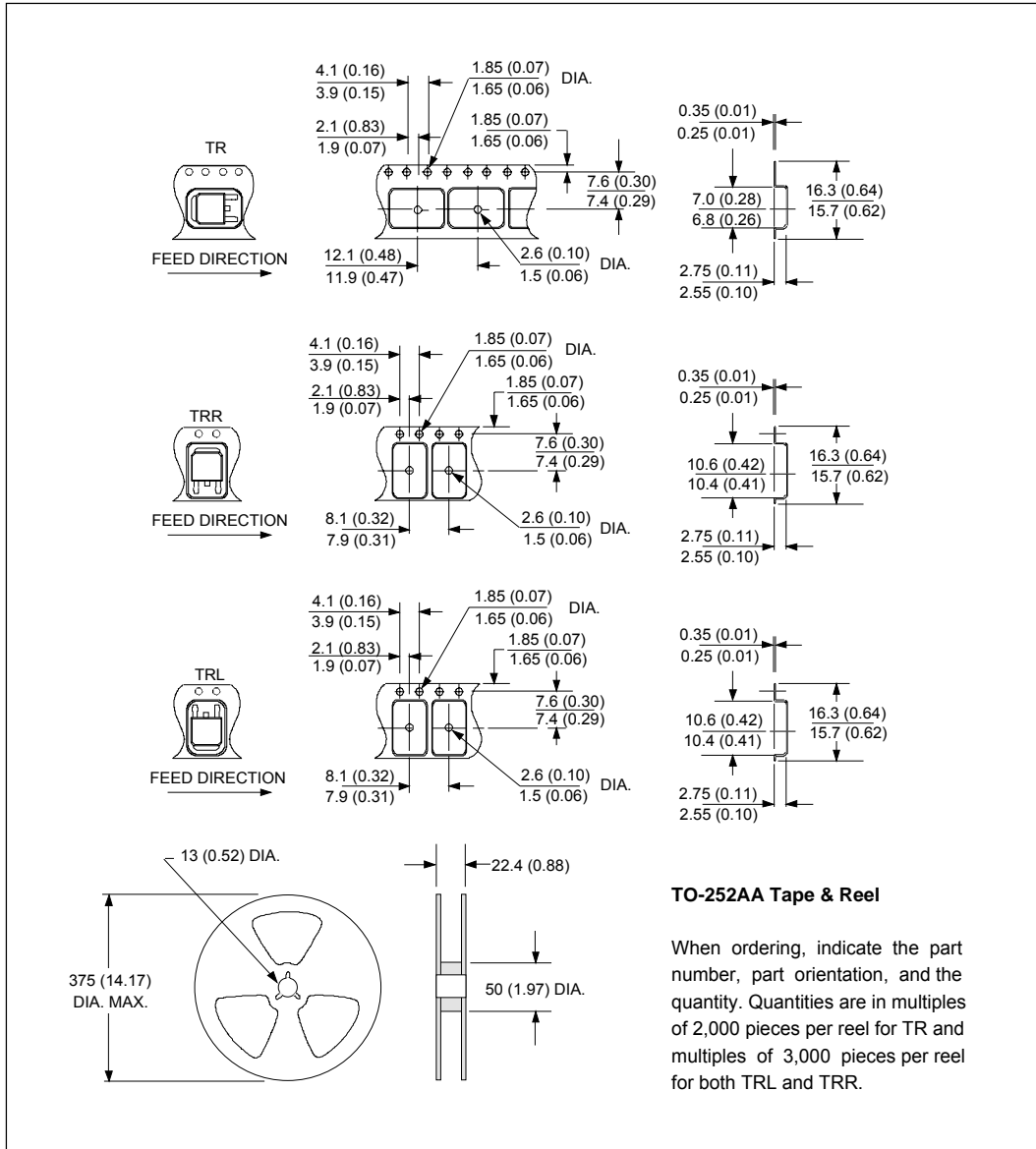

TO-252AA Tape & Reel

When ordering, indicate the part number, part orientation, and the quantity. Quantities are in multiples of 2,000 pieces per reel for TR and multiples of 3,000 pieces per reel for both TRL and TRR.

Ordering Information Table

Device Code							
6	C	W	Q	03	FN	TRL	-
①	②	③	④	⑤	⑥	⑦	⑧
1	- Current Rating (7A)						
2	- Center Tap Configuration						
3	- Package Identifier W = D-Pak						
4	- Schottky "Q" Series						
5	- Voltage Rating (03 = 30V)						
6	- FN = TO-252AA						
7	- <ul style="list-style-type: none"> • none = Tube (50 pieces) • TR = Tape & Reel • TRL = Tape & Reel (Left Oriented) • TRR = Tape & Reel (Right Oriented) 						
8	- <ul style="list-style-type: none"> • none = Standard Production • PbF = Lead-Free 						

Data and specifications subject to change without notice.
 This product has been designed and qualified for AEC Q101 Level.
 Qualification Standards can be found on IR's Web site.



Notice

The products described herein were acquired by Vishay Intertechnology, Inc., as part of its acquisition of International Rectifier's Power Control Systems (PCS) business, which closed in April 2007. Specifications of the products displayed herein are pending review by Vishay and are subject to the terms and conditions shown below.

Specifications of the products displayed herein are subject to change without notice. Vishay Intertechnology, Inc., or anyone on its behalf, assumes no responsibility or liability for any errors or inaccuracies.

Information contained herein is intended to provide a product description only. No license, express or implied, by estoppel or otherwise, to any intellectual property rights is granted by this document. Except as provided in Vishay's terms and conditions of sale for such products, Vishay assumes no liability whatsoever, and disclaims any express or implied warranty, relating to sale and/or use of Vishay products including liability or warranties relating to fitness for a particular purpose, merchantability, or infringement of any patent, copyright, or other intellectual property right.

The products shown herein are not designed for use in medical, life-saving, or life-sustaining applications. Customers using or selling these products for use in such applications do so at their own risk and agree to fully indemnify Vishay for any damages resulting from such improper use or sale.

International Rectifier®, IR®, the IR logo, HEXFET®, HEXSense®, HEXDIP®, DOL®, INTERO®, and POWIRTRAIN® are registered trademarks of International Rectifier Corporation in the U.S. and other countries. All other product names noted herein may be trademarks of their respective owners.