

## Fast Recovery Diodes (Stud Version), 40 A, 70 A, 85 A



DO-5 (DO-203AB)

### FEATURES

- Short reverse recovery time
- Low stored charge
- Wide current range
- Excellent surge capabilities
- Stud cathode and stud anode versions
- Types up to 100 V<sub>RRM</sub>
- Material categorization: for definitions of compliance please see [www.vishay.com/doc?99912](http://www.vishay.com/doc?99912)

**RoHS**  
COMPLIANT

### TYPICAL APPLICATIONS

- DC power supplies
- Inverters
- Converters
- Choppers
- Ultrasonic systems
- Freewheeling diodes

### PRIMARY CHARACTERISTICS

I <sub>F(AV)</sub>	40 A, 70 A, 85 A
Package	DO-5 (DO-203AB)
Circuit Configuration	Single

### MAJOR RATINGS AND CHARACTERISTICS

PARAMETER	TEST CONDITIONS	40HFL	70HFL	85HFL	UNITS
I <sub>F(AV)</sub>		40	70	85	A
	T <sub>C</sub> maximum	85	85	85	°C
I <sub>FSM</sub>	50 Hz	400	700	1100	A
	60 Hz	420	730	1151	
I <sup>2</sup> t	50 Hz	800	2450	6050	A <sup>2</sup> s
	60 Hz	730	2240	5523	
I <sup>2</sup> √t		11 300	34 650	85 560	I <sup>2</sup> √s
V <sub>RRM</sub>	Range	100 to 1000	100 to 1000	100 to 1000	V
t <sub>rr</sub>		See Recovery Characteristics table	See Recovery Characteristics table	See Recovery Characteristics table	ns
T <sub>J</sub>	Range	-40 to +125	-40 to +125	-40 to +125	°C



## ELECTRICAL SPECIFICATIONS

VOLTAGE RATINGS				
TYPE NUMBER <sup>(1)</sup>	V <sub>RRM</sub> , MAXIMUM PEAK REPETITIVE REVERSE VOLTAGE T <sub>J</sub> = - 40 °C TO 125 °C V	V <sub>RSM</sub> , MAXIMUM PEAK NON-REPETITIVE REVERSE VOLTAGE T <sub>J</sub> = 25 °C TO 125 °C V	I <sub>FM</sub> , MAXIMUM PEAK REVERSE CURRENT AT RATED V <sub>RRM</sub> mA	
			T <sub>J</sub> = 25 °C	T <sub>J</sub> = 125 °C
VS-40HFL10S02, VS-40HFL10S05	100	150	0.1	10
VS-40HFL20S02, VS-40HFL20S05	200	300		
VS-40HFL40S02, VS-40HFL40S05	400	500		
VS-40HFL60S02, VS-40HFL60S05	600	700		
VS-40HFL80S05	800	900		
VS-40HFL100S05	1000	1100		
VS-70HFL10S02, VS-70HFL10S05	100	150	0.1	15
VS-70HFL20S02, VS-70HFL20S05	200	300		
VS-70HFL40S02, VS-70HFL40S05	400	500		
VS-70HFL60S02, VS-70HFL60S05	600	700		
VS-70HFL80S05	800	900		
VS-70HFL100S05	1000	1100		
VS-85HFL10S02, VS-85HFL10S05	100	150	0.1	20
VS-85HFL20S02, VS-85HFL20S05	200	300		
VS-85HFL40S02, VS-85HFL40S05	400	500		
VS-85HFL60S02, VS-85HFL60S05	600	700		
VS-85HFL80S05	800	900		
VS-85HFL100S05	1000	1100		

**Note**

<sup>(1)</sup> Types listed are cathode case, for anode case add "R" to code, i.e. 40HFLR20S02, 85HFLR100S05 etc.

FORWARD CONDUCTION							
PARAMETER	SYMBOL	TEST CONDITIONS	40HFL	70HFL	85HFL	UNITS	
Maximum average forward current at maximum case temperature	I <sub>F(AV)</sub>	180° conduction, half sine wave	40	70	85	A	
			75			°C	
Maximum RMS forward current	I <sub>F(RMS)</sub>		63	110	134	A	
Maximum peak repetitive forward current	I <sub>FRM</sub>	Sinusoidal half wave, 30° conduction	220	380	470	A	
Maximum peak, one-cycle non-repetitive forward current	I <sub>FSM</sub>	t = 10 ms	Sinusoidal half wave, 100 % V <sub>RRM</sub> reapplied, initial T <sub>J</sub> = T <sub>J</sub> maximum	400	700	1100	A
		t = 8.3 ms		420	730	1151	
		t = 10 ms	Sinusoidal half wave, no voltage reapplied, initial T <sub>J</sub> = T <sub>J</sub> maximum	475	830	1308	
		t = 8.3 ms		500	870	1369	
Maximum I <sup>2</sup> t for fusing	I <sup>2</sup> t	t = 10 ms	100 % V <sub>RRM</sub> reapplied, initial T <sub>J</sub> = T <sub>J</sub> maximum	800	2450	6050	A <sup>2</sup> s
		t = 8.3 ms		730	2240	5523	
		t = 10 ms	No voltage reapplied, initial T <sub>J</sub> = T <sub>J</sub> maximum	1130	3460	8556	
		t = 8.3 ms		1030	3160	7810	
Maximum I <sup>2</sup> √t for fusing <sup>(1)</sup>	I <sup>2</sup> √t	t = 0.1 ms to 10 ms, no voltage reapplied	11 300	34 650	85 560	A <sup>2</sup> √s	
Maximum value of threshold voltage	V <sub>F(TO)</sub>	T <sub>J</sub> = 125 °C	1.081	1.085	1.128	V	
Maximum value of forward slope resistance	r <sub>F</sub>		6.33	3.40	2.11	mΩ	
Maximum forward voltage drop	V <sub>FM</sub>	T <sub>J</sub> = 25 °C, I <sub>FM</sub> = π x I <sub>F(AV)</sub>	1.95	1.85	1.75	V	

**Note**

<sup>(1)</sup> I<sup>2</sup>t for time t<sub>x</sub> = I<sup>2</sup>√t x √t<sub>x</sub>

RECOVERY CHARACTERISTICS									
PARAMETER	SYMBOL	TEST CONDITIONS	40HFL...		70HFL...		85HFL...		UNITS
			S02	S05	S02	S05	S02	S05	
Typical reverse recovery time	$t_{rr}$	$T_J = 25\text{ }^\circ\text{C}$ , $I_F = 1\text{ A}$ to $V_R = 30\text{ V}$ , $di_F/dt = 100\text{ A}/\mu\text{s}$	70	180	60	150	50	120	ns
		$T_J = 25\text{ }^\circ\text{C}$ , $-di_F/dt = 25\text{ A}/\mu\text{s}$ , $I_{FM} = \pi \times \text{rated } I_{F(AV)}$	200	500	200	500	200	500	
Typical reverse recovered charge	$Q_{rr}$	$T_J = 25\text{ }^\circ\text{C}$ , $I_F = 1\text{ A}$ to $V_R = 30\text{ V}$ , $di_F/dt = 100\text{ A}/\mu\text{s}$	160	750	90	500	70	340	nC
		$T_J = 25\text{ }^\circ\text{C}$ , $-di_F/dt = 25\text{ A}/\mu\text{s}$ , $I_{FM} = \pi \times \text{rated } I_{F(AV)}$	240	1300	240	1300	240	1300	

THERMAL AND MECHANICAL SPECIFICATIONS						
PARAMETER	SYMBOL	TEST CONDITIONS	40HFL	70HFL	85HFL	UNITS
Junction operating temperature range	$T_J$		-40 to 125			°C
Storage temperature range	$T_{Stg}$		-40 to 150			
Maximum thermal resistance, junction to case	$R_{thJC}$	DC operation	0.60	0.36	0.30	K/W
Maximum thermal resistance, case to heatsink	$R_{thCS}$	Mounting surface, smooth, flat and greased	0.25			
Maximum allowable mounting torque (+ 0 %, - 10 %)		Not lubricated thread, tightening on nut <sup>(1)</sup>	3.4 (30)			N · m (lbf · in)
		Lubricated thread, tightening on nut <sup>(1)</sup>	2.3 (20)			
		Not lubricated thread, tightening on hexagon <sup>(2)</sup>	4.2 (37)			
		Lubricated thread, tightening on hexagon <sup>(2)</sup>	3.2 (28)			
Approximate weight			25			
			0.88			
Case style		JEDEC®	DO-5 (DO-203AB)			

**Notes**

- (1) Recommended for pass-through holes  
 (2) Recommended for holed threaded heatsinks



- $I_F, I_{FM}$  - Peak forward current prior to commutation  
 $-di_F/dt$  - Rate of fall forward current  
 $I_{RRM(REC)}$  - Peak reverse recovery current  
 $t_{rr}$  - Reverse recovery time  
 $Q_{rr}$  - Reverse recovered charge

Fig. 1 - Reverse Recovery Time Test Waveform

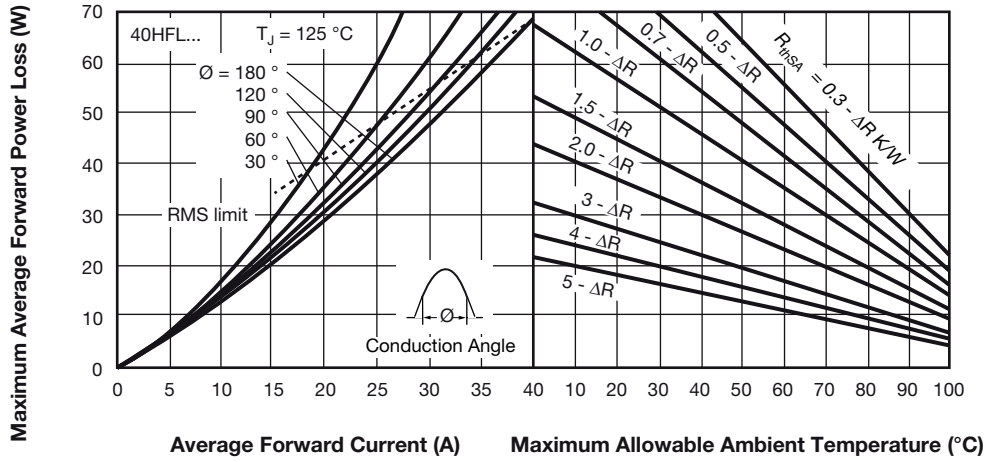

Fig. 2 - Current Rating Nomogram (Sinusoidal Waveforms), 40HFL Series

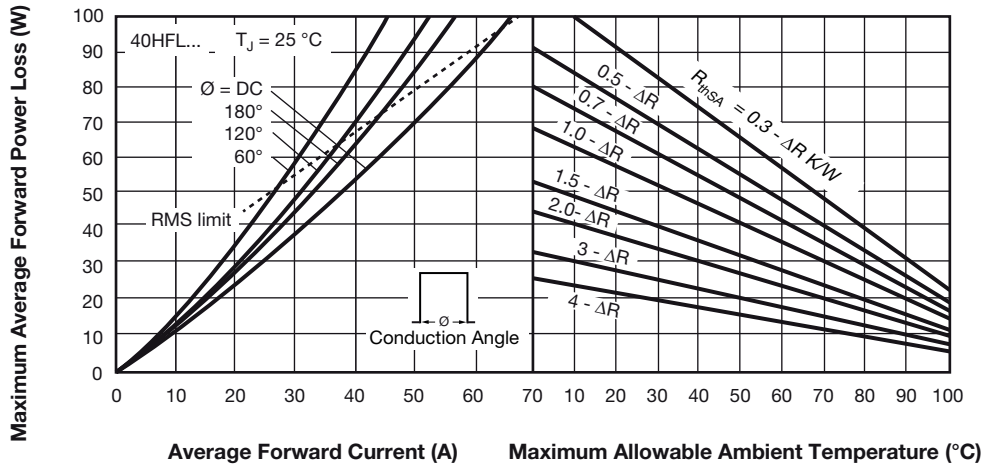

Fig. 3 - Current Rating Nomogram (Rectangular Waveforms), 40HFL Series

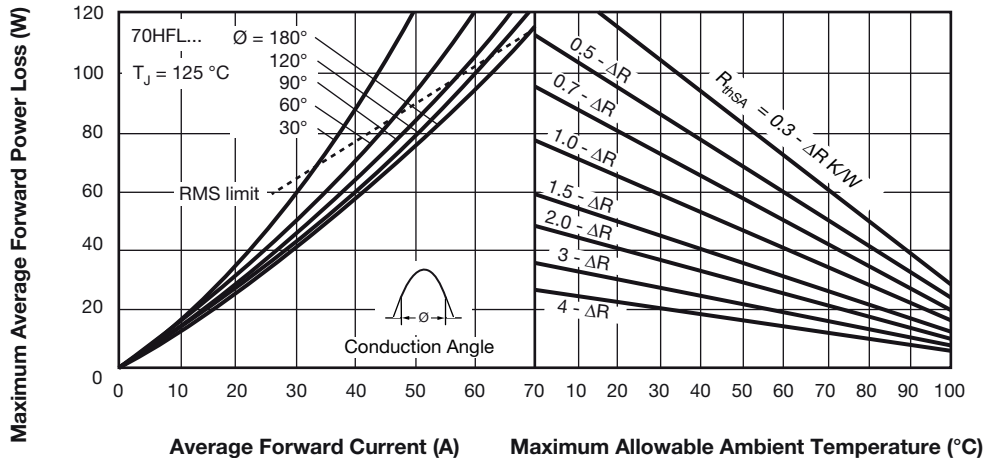

Fig. 4 - Current Rating Nomogram (Sinusoidal Waveforms), 70HFL Series

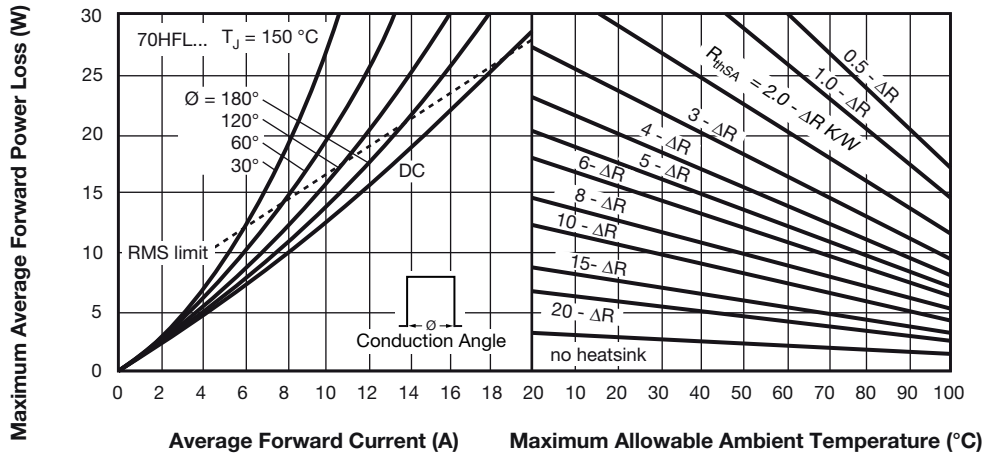

Fig. 5 - Current Rating Nomogram (Rectangular Waveforms), 70HFL Series

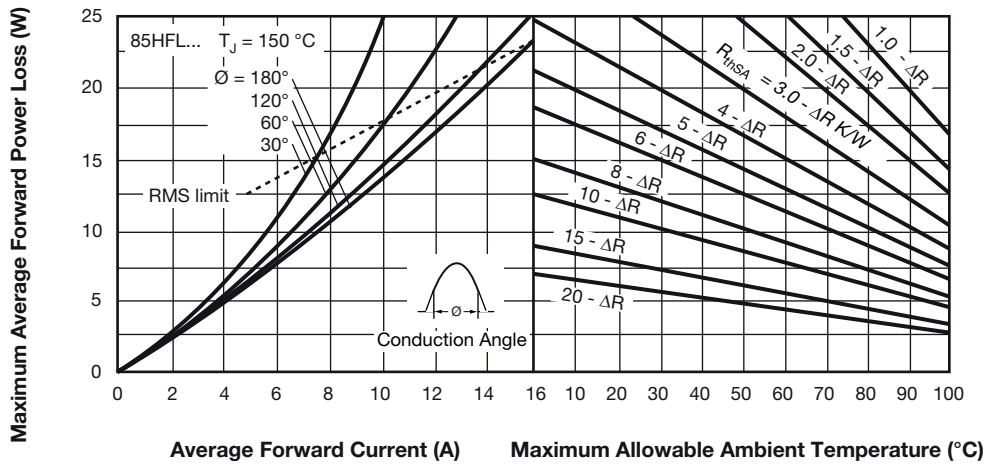

Fig. 6 - Current Rating Nomogram (Sinusoidal Waveforms), 85HFL Series

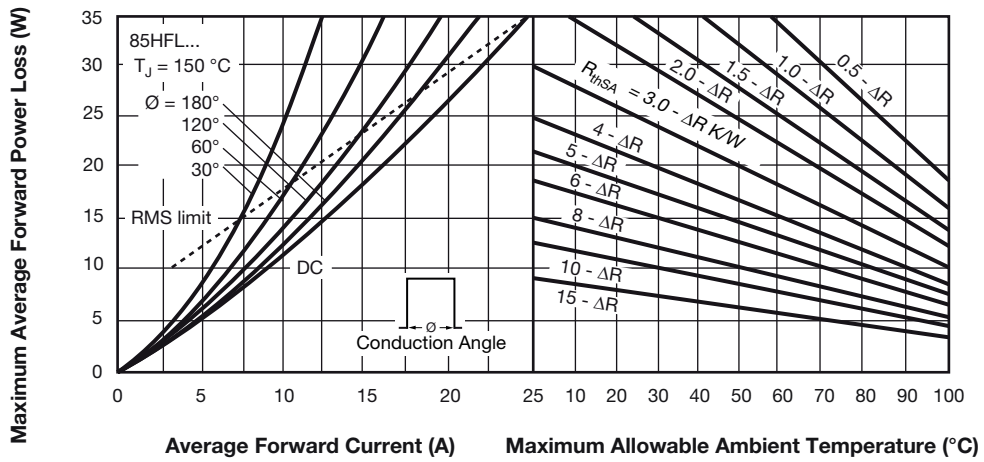

Fig. 7 - Current Rating Nomogram (Rectangular Waveforms), 85HFL Series



Fig. 8 - Maximum High Level Forward Power Loss vs. Average Forward Current, 40HFL Series

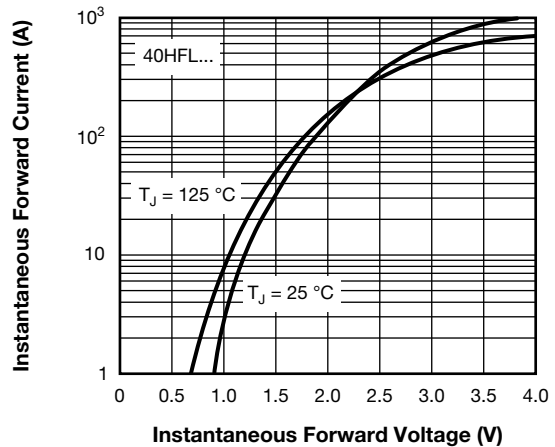

Fig. 11 - Maximum Forward Voltage vs. Forward Current, 40HFL Series



Fig. 9 - Maximum High Level Forward Power Loss vs. Average Forward Current, 70HFL Series

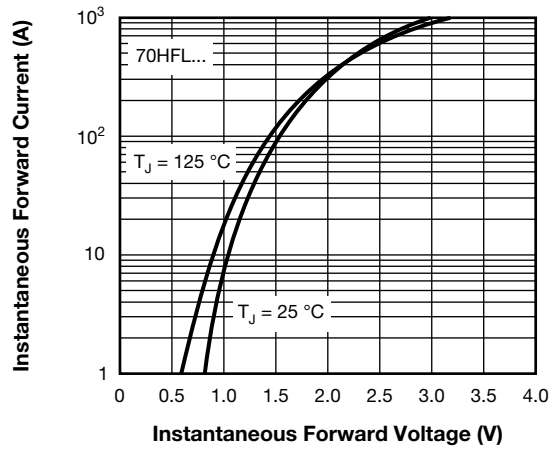

Fig. 12 - Maximum Forward Voltage vs. Forward Current, 70HFL Series



Fig. 10 - Maximum High Level Forward Power Loss vs. Average Forward Current, 85HFL Series

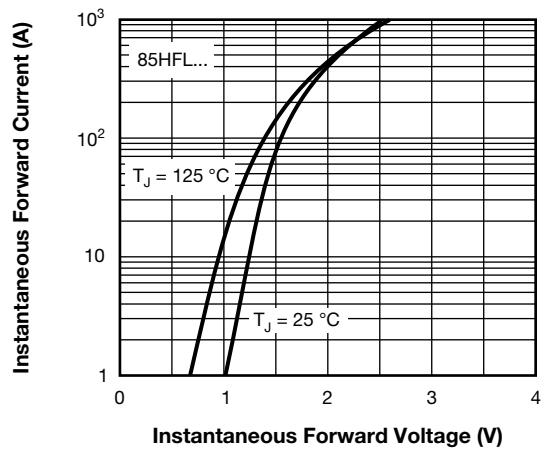

Fig. 13 - Maximum Forward Voltage vs. Forward Current, 85HFL Series

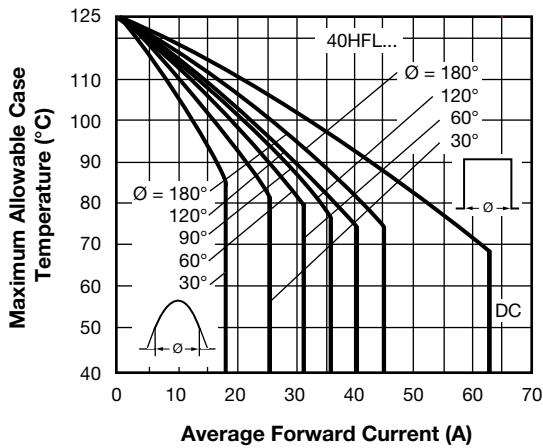

Fig. 14 - Average Forward Current vs. Maximum Allowable Case Temperature, 40HFL Series

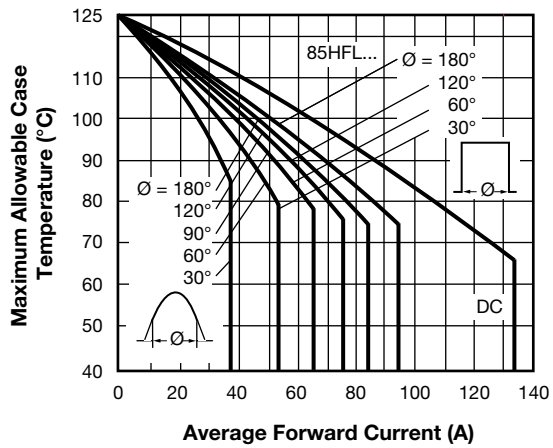

Fig. 16 - Average Forward Current vs. Maximum Allowable Case Temperature, 85HFL Series

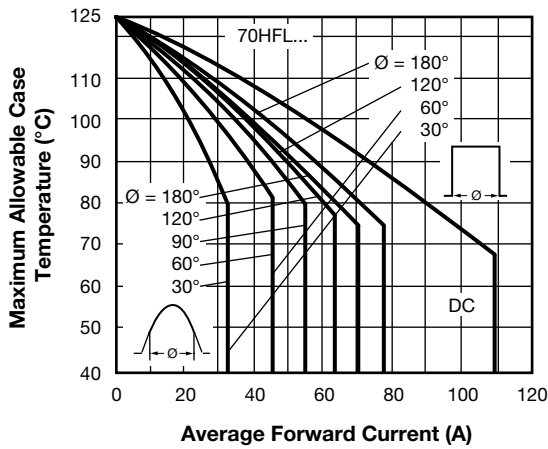

Fig. 15 - Average Forward Current vs. Maximum Allowable Case Temperature, 70HFL Series

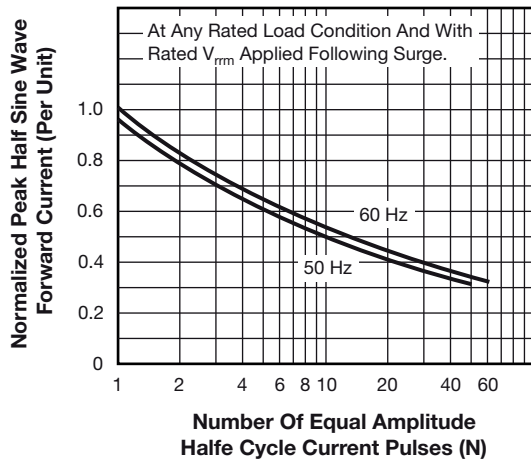

Fig. 17 - Maximum Non-Repetitive Surge Current vs. Number of Current Pulses, All Series

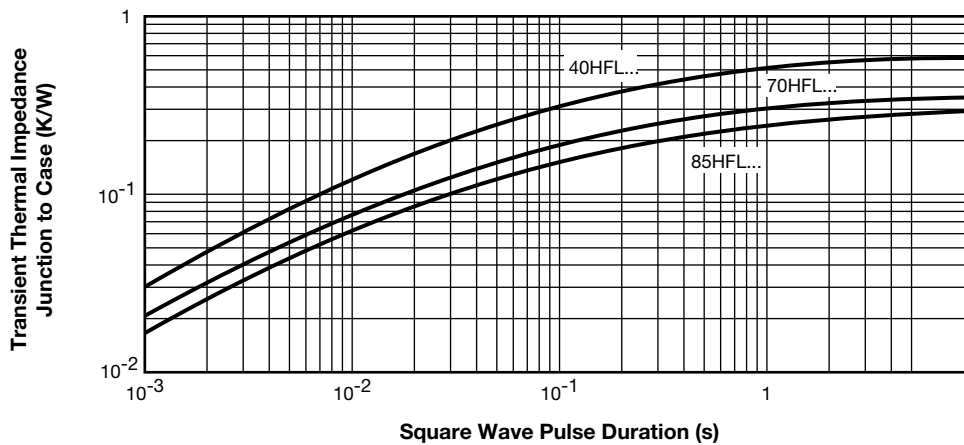

Fig. 18 - Maximum Transient Thermal Impedance, Junction to Case vs. Pulse Duration, All Series

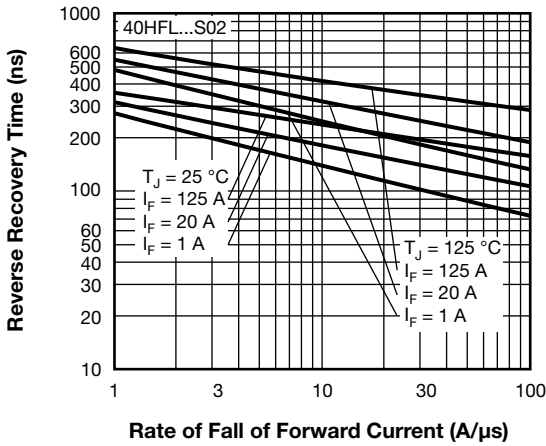

Fig. 19 - Typical Reverse Recovery Time vs. Rate of Fall of Forward Current, 40HFL...S02 Series

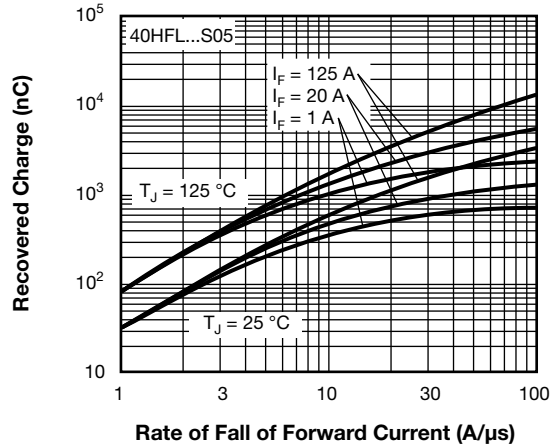

Fig. 22 - Typical Recovered Charge vs. Rate of Fall of Forward Current, 40HFL...S05 Series

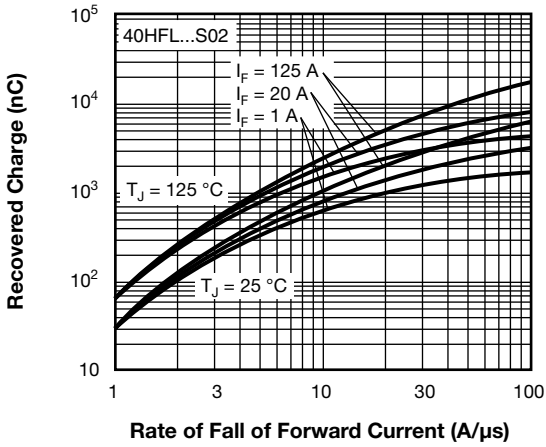

Fig. 20 - Typical Recovered Charge vs. Rate of Fall of Forward Current, 40HFL...S02 Series

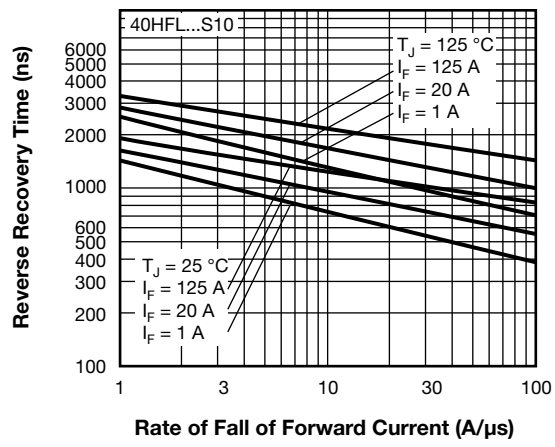

Fig. 23 - Typical Reverse Recovery Time vs. Rate of Fall of Forward Current, 40HFL...Series

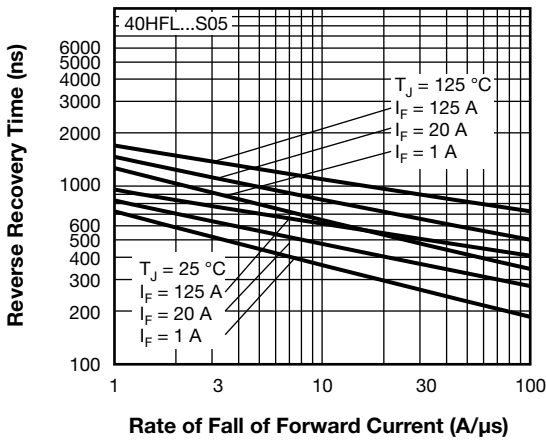

Fig. 21 - Typical Reverse Recovery Time vs. Rate of Fall of Forward Current, 40HFL...S05 Series

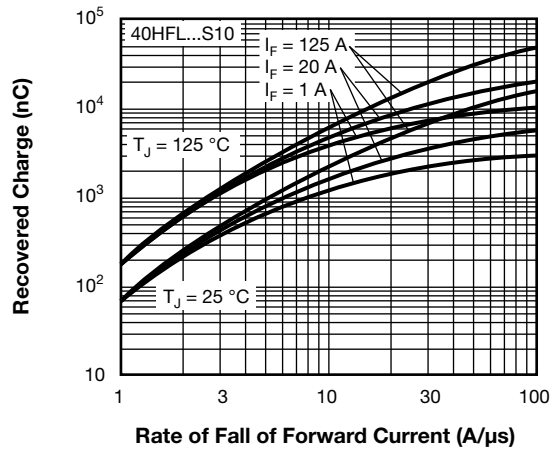

Fig. 24 - Typical Recovered Charge vs. Rate of Fall of Forward Current, 40HFL...Series



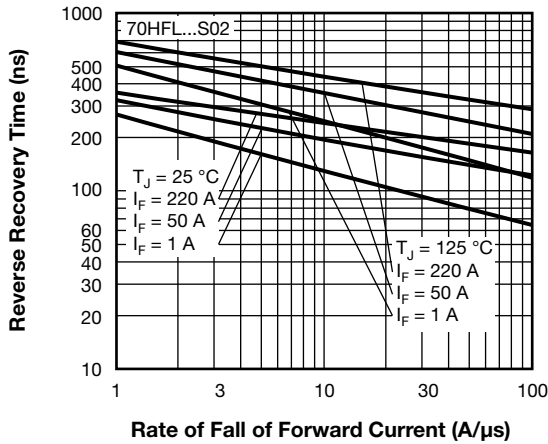

Fig. 25 - Typical Reverse Recovery Time vs. Rate of Fall of Forward Current, 70HFL...S02 Series

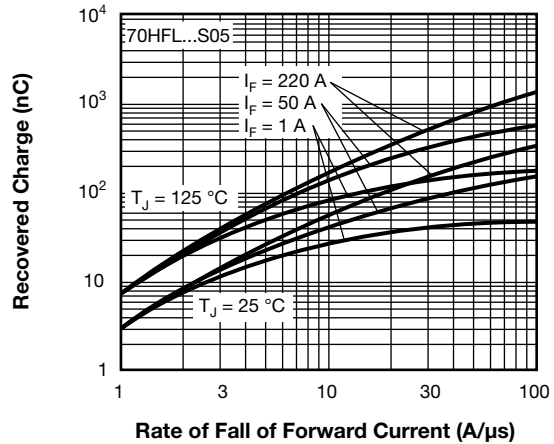

Fig. 28 - Typical Recovered Charge vs. Rate of Fall of Forward Current, 70HFL...S05 Series

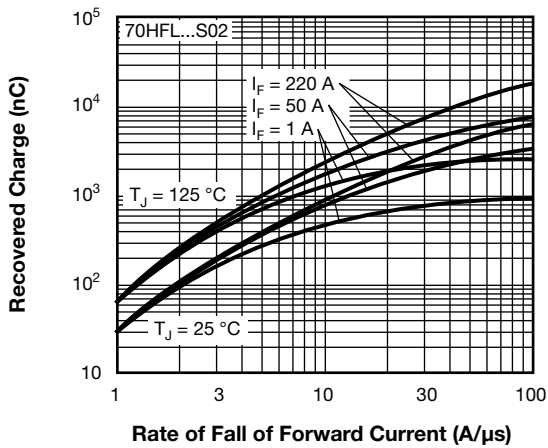

Fig. 26 - Typical Recovered Charge vs. Rate of Fall of Forward Current, 70HFL...S02 Series

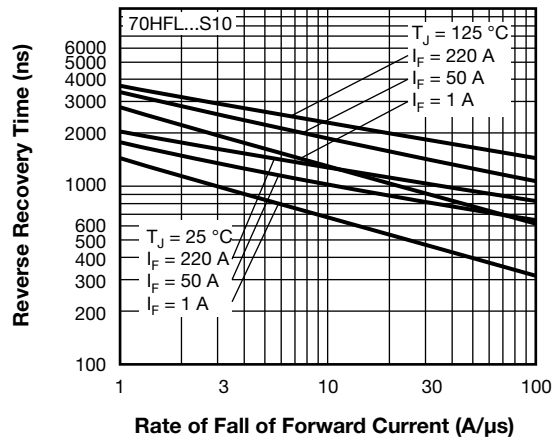

Fig. 29 - Typical Reverse Recovery Time vs. Rate of Fall of Forward Current, 70HFL... Series

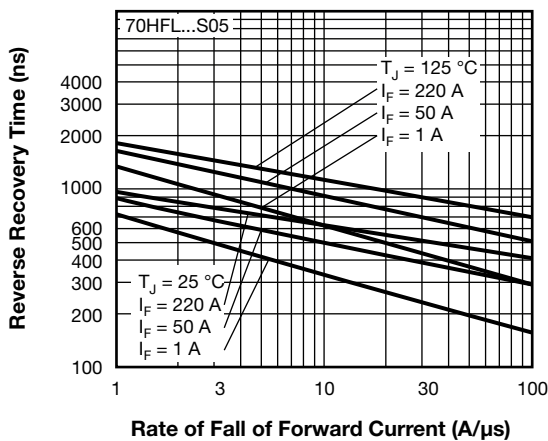

Fig. 27 - Typical Reverse Recovery Time vs. Rate of Fall of Forward Current, 70HFL...S05 Series

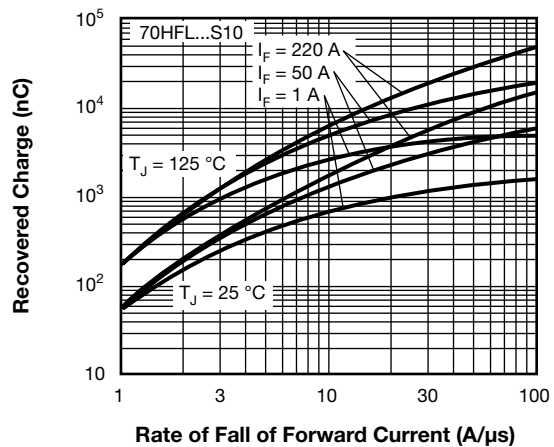
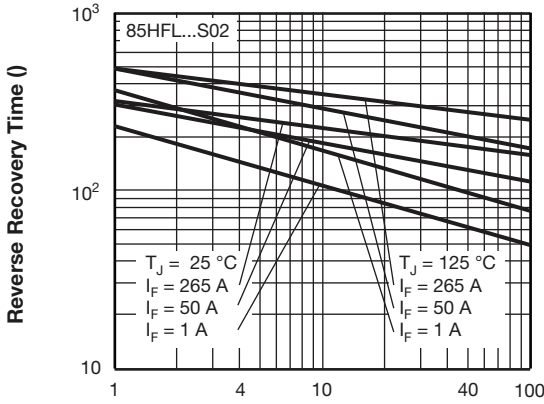
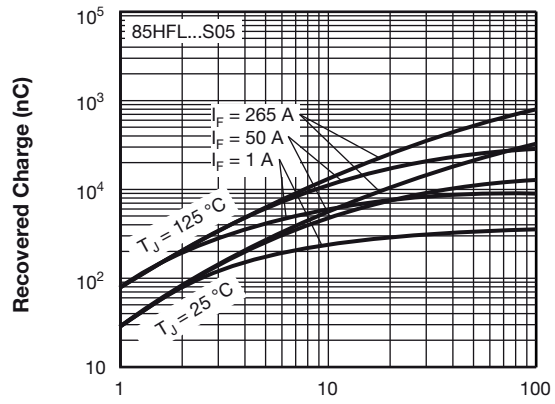

Fig. 30 - Typical Recovered Charge vs. Rate of Fall of Forward Current, 70HFL... Series



**Rate of Fall of Forward Current (A/μs)**  
 Fig. 31 - Typical Reverse Recovery Time vs. Rate of Fall of Forward Current, 85HFL...S02 Series



**Rate of Fall of Forward Current (A/μs)**  
 Fig. 34 - Typical Recovered Charge vs. Rate of Fall of Forward Current, 85HFL...S05 Series

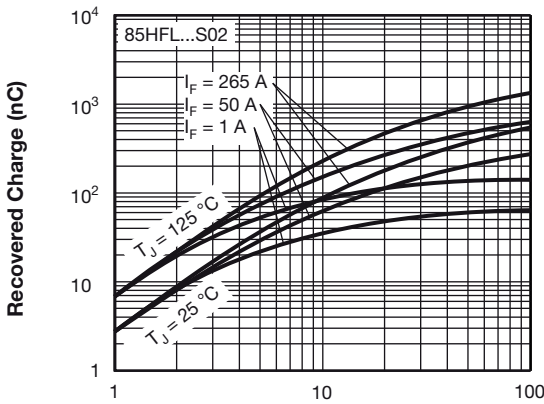

**Rate of Fall of Forward Current (A/μs)**  
 Fig. 32 - Typical Recovered Charge vs. Rate of Fall of Forward Current, 85HFL...S02 Series

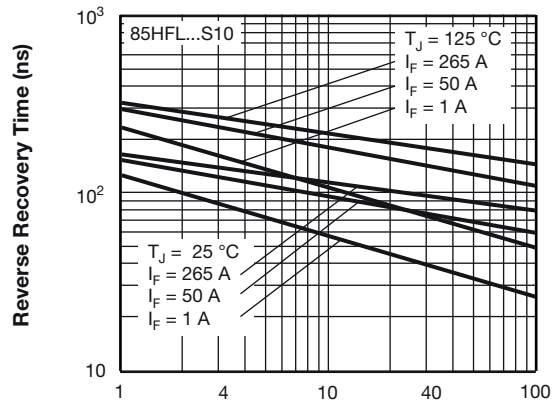

**Rate of Fall of Forward Current (A/μs)**  
 Fig. 35 - Typical Reverse Recovery Time vs. Rate of Fall of Forward Current, 85HFL... Series

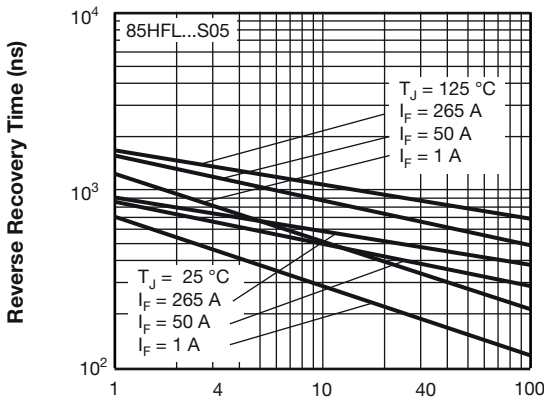

**Rate of Fall of Forward Current (A/μs)**  
 Fig. 33 - Typical Reverse Recovery Time vs. Rate of Fall of Forward Current, 85HFL...S05 Series

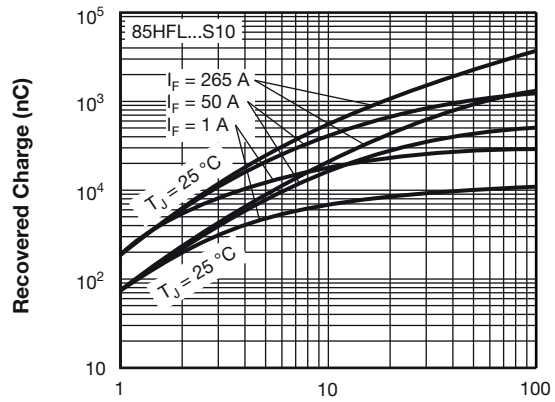

**Rate of Fall of Forward Current (A/μs)**  
 Fig. 36 - Typical Recovered Charge vs. Rate of Fall of Forward Current, 85HFL... Series



## ORDERING INFORMATION TABLE

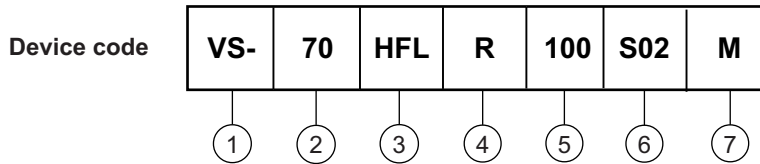

- 1** - Vishay Semiconductors product
- 2** -
  - 70 = standard device (current rating: 40 = 40 A, 70 = 70 A, 85 = 85 A)
  - 71 = not isolated lead
  - 72, 87 = isolated lead with silicone sleeve  
(red = reverse polarity)  
(blue = normal polarity)
- 3** - HFL = fast recovery diode
- 4** -
  - None = stud normal polarity (cathode to stud)
  - R = stud reverse polarity (anode to stud)
- 5** - Voltage code x 10 =  $V_{RRM}$  (see "Voltage Ratings" table)
- 6** - Refer to "Recovery Characteristics" table
- 7** -
  - None = stud base DO-5 (DO-203AB) 1/4" 28UNF-2A
  - M = stud base DO-5 (DO-203AB) M6 x 1

LINKS TO RELATED DOCUMENTS	
Dimensions	<a href="http://www.vishay.com/doc?95312">www.vishay.com/doc?95312</a>

## DO-203AB (DO-5) for 40HFL, 70HFL and 85HFL

### DIMENSIONS FOR 40HFL/70HFL in millimeters (inches)

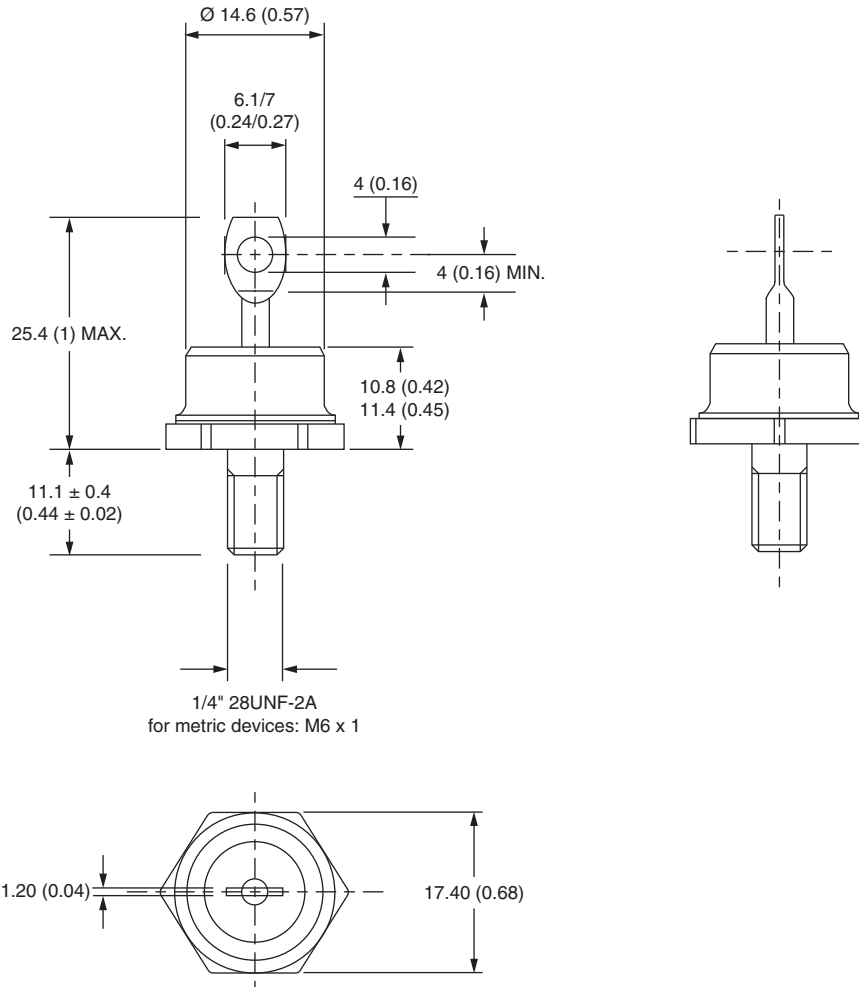

# Outline Dimensions

Vishay Semiconductors

DO-203AB (DO-5) for  
40HFL, 70HFL and 85HFL



## DIMENSIONS FOR 85HFL in millimeters (inches)

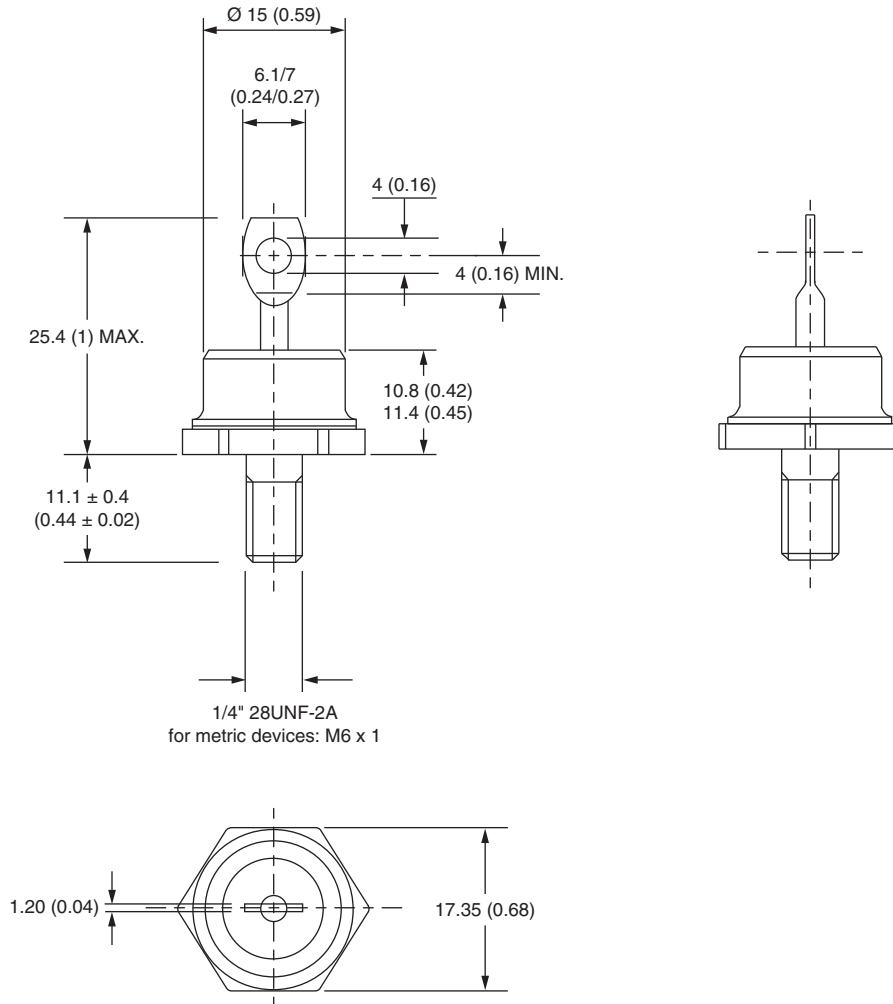



## **Disclaimer**

ALL PRODUCT, PRODUCT SPECIFICATIONS AND DATA ARE SUBJECT TO CHANGE WITHOUT NOTICE TO IMPROVE RELIABILITY, FUNCTION OR DESIGN OR OTHERWISE.

Vishay Intertechnology, Inc., its affiliates, agents, and employees, and all persons acting on its or their behalf (collectively, "Vishay"), disclaim any and all liability for any errors, inaccuracies or incompleteness contained in any datasheet or in any other disclosure relating to any product.

Vishay makes no warranty, representation or guarantee regarding the suitability of the products for any particular purpose or the continuing production of any product. To the maximum extent permitted by applicable law, Vishay disclaims (i) any and all liability arising out of the application or use of any product, (ii) any and all liability, including without limitation special, consequential or incidental damages, and (iii) any and all implied warranties, including warranties of fitness for particular purpose, non-infringement and merchantability.

Statements regarding the suitability of products for certain types of applications are based on Vishay's knowledge of typical requirements that are often placed on Vishay products in generic applications. Such statements are not binding statements about the suitability of products for a particular application. It is the customer's responsibility to validate that a particular product with the properties described in the product specification is suitable for use in a particular application. Parameters provided in datasheets and / or specifications may vary in different applications and performance may vary over time. All operating parameters, including typical parameters, must be validated for each customer application by the customer's technical experts. Product specifications do not expand or otherwise modify Vishay's terms and conditions of purchase, including but not limited to the warranty expressed therein.

Except as expressly indicated in writing, Vishay products are not designed for use in medical, life-saving, or life-sustaining applications or for any other application in which the failure of the Vishay product could result in personal injury or death. Customers using or selling Vishay products not expressly indicated for use in such applications do so at their own risk. Please contact authorized Vishay personnel to obtain written terms and conditions regarding products designed for such applications.

No license, express or implied, by estoppel or otherwise, to any intellectual property rights is granted by this document or by any conduct of Vishay. Product names and markings noted herein may be trademarks of their respective owners.