

Input Attenuator Module

Features

- EMI filtering-MIL-STD-461E⁽¹⁾
- Transient protection-MIL-STD-704E/F
- Environments-MIL-STD-810, MIL-STD-202
- Environmental stress screening
- Low profile mounting options
- Output power up to 560 W
- Output current up to 20 A
- Mini sized package
- Inrush current limiting

Product Highlights

The M-FIAM5B is a DC front-end module that provides EMI filtering and transient protection. The M-FIAM5B enables designers using Vicor's Maxi, Mini, Micro Series 24 V DC-DC converters to meet conducted emission / conducted susceptibility per MIL-STD-461E; and input transients per MIL-STD-704E/F. The M-FIAM5B accepts an input voltage of 14 – 36 Vdc and delivers output current up to 20 A.

M-FIAM5B is housed in an industry standard "half brick" module measuring 2.28" x 2.2" x 0.5" and depending upon model selected, may be mounted onboard or inboard for height critical applications.

Compatible Products

- Maxi, Mini, Micro Series 24 V Input DC-DC converters
- 24 V Input VIPAC Arrays

⁽¹⁾EMI performance is subject to a wide variety of external influences such as PCB construction, circuit layout etc. As such, external components in addition to those listed herein may be required in specific instances to gain full compliance to the standards specified.



Actual Size:
2.28 x 2.2 x 0.5 in
57,9 x 55,9 x 12,7 mm

Absolute Maximum Rating

Parameter	Rating	Unit	Notes
+In to -In	36	Vdc	Continuous
	50	Vdc	12.5 ms, See Fig.3
Mounting torque	5 (0.57)	in-lbs	6 each, #4-40 or M3
Pin soldering temperature	500 (260)	°F(°C)	<5 sec; wave solder
	750 (390)	°F(°C)	<7 sec; hand solder

Thermal Resistance and Capacity

Parameter	Min	Typ	Max	Unit
Baseplate to sink				
	flat, greased surface		0.16	°C/Watt
	with thermal pad (P/N 20264)		0.1	°C/Watt
Baseplate to ambient				
	Free convection		7.9	°C/Watt
	1000 LFM		2.2	°C/Watt

MTBF per MIL-HDBK-217F (M-FIAM5BM21)

Temperature	Environment	MTBF	Unit
25°C	Ground Benign: G.B.	2,533	1,000 Hrs
50°C	Naval Sheltered: N.S.	456	1,000 Hrs
65°C	Airborne Inhabited Cargo: A.I.C.	375	1,000 Hrs

Part Numbering*

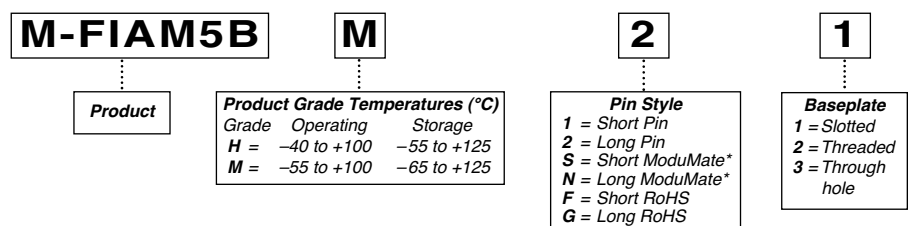

*Compatible with SurfMate and InMate socketing system.

SPECIFICATIONS

(typical at $T_{BP} = 25^{\circ}\text{C}$, nominal line and 75% load, unless otherwise specified)

INPUT SPECIFICATIONS

Parameter	Min	Typ	Max	Unit	Notes
Input voltage	14	28	36	Vdc	Continuous
Inrush limiting			0.007	A/ μF	
Transient immunity			50	Vdc	12.5 ms per MIL-STD-704E/F, continuous operation Test conditions AA and FF normal overvoltage transients per MIL-HDBK-704

OUTPUT SPECIFICATIONS

Parameter	Min	Typ	Max	Unit	Notes
Output current			20	A	
Output power			560	W	
Efficiency	96	98		%	
Internal voltage drop		0.5	0.7	Vdc	@20 A, 100°C baseplate
External capacitance	330		1000	μF	See Figure 5 on page 4 50 V

CONTROL PIN SPECIFICATIONS

Parameter	Min	Typ	Max	Unit	Notes
ON/OFF control					
Enable (ON)	0.0		1.0	Vdc	Referenced to – Vout
Disable (OFF)	3.5		5.0	Vdc	100 k Ω internal pull up resistor

SAFETY SPECIFICATIONS

Parameter	Min	Typ	Max	Unit	Notes
Dielectric withstand		1,500	Vrms		Input / Output to Base
		2,121	Vdc		Input / Output to Base

EMI

Standard	Test Procedure	Notes
MIL-STD-461E		
Conducted emissions:	CE101, CE102	
Conducted susceptibility:	CS101, CS114, CS115, CS116	

EMI performance is subject to a wide variety of external influences such as PCB construction, circuit layout etc. As such, external components in addition to those listed herein may be required in specific instances to gain full compliance to the standards specified.

GENERAL SPECIFICATIONS

Parameter	Min	Typ	Max	Unit	Notes
Weight			3.3 (94)	Ounces (grams)	
Warranty			2	Years	

SPECIFICATIONS (CONT.)

■ ENVIRONMENTAL QUALIFICATION

Altitude	MIL-STD-810F, Method 500.4, Procedure I & II, 40,000 ft. and 70,000 ft. Operational.
Explosive Atmosphere	MIL-STD-810F, Method 511.4, Procedure I, Operational.
Vibration	MIL-STD-810F, Method 514.5, Procedure I, Category 14, Sine and Random vibration per Table 514.5C for Helicopter AH-6J Main Rotor with overall level of 5.6 G rms for 4 hours per axis. MIL-STD-810F, Method 514.5C, General Minimum Integrity Curve per Figure 514.5C-17 with overall level of 7.7 G rms for 1 hour per axis.
Shock	MIL-STD-810F, Method 516.5, Procedure I, Functional Shock, 40 g. MIL-S-901D, Lightweight Hammer Shock, 3 impacts/axis, 1,3,5 ft. MIL-STD-202F, Method 213B, 60 g, 9 ms half sine. MIL-STD-202F, Method 213B, 75 g, 11 ms Saw Tooth Shock.
Acceleration	MIL-STD-810F, Method 513.5, Procedure II, table 513.5-II, Operational, 2-7 g, 6 directions.
Humidity	MIL-STD-810F, Method 507.4.
Solder Test	MIL-STD-202G, Method 208H, 8 hour aging.

■ ENVIRONMENTAL STRESS SCREENING

Parameter	H-Grade	M-Grade
Operating temperature	-40°C to +100°C	-55°C to +100°C
Storage temperature	-55°C to +125°C	-65°C to +125°C
Temperature cycling*	12 cycles -65°C to +100°C	12 cycles -65°C to +100°C
Ambient test @ 25°C	Yes	Yes
Power cycling burn-in	12 hours, 29 cycles	24 hours, 58 cycles
Functional and parametric ATE tests	-40°C and +100°C	-55°C and +100°C
Hi-Pot test	Yes	Yes
Visual inspection	Yes	Yes
Test data	vicorpower.com	vicorpower.com

*Temperature cycled with power off, 17°C per minute rate of change.

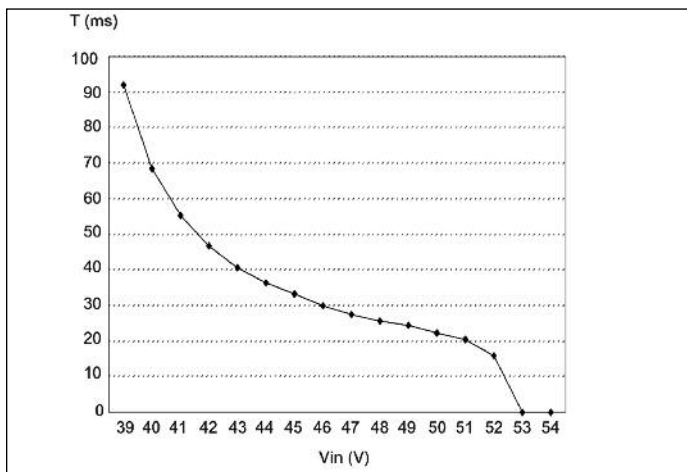

Figure 1 — Shut Down Time of M-FIAM5B vs. Overvoltage

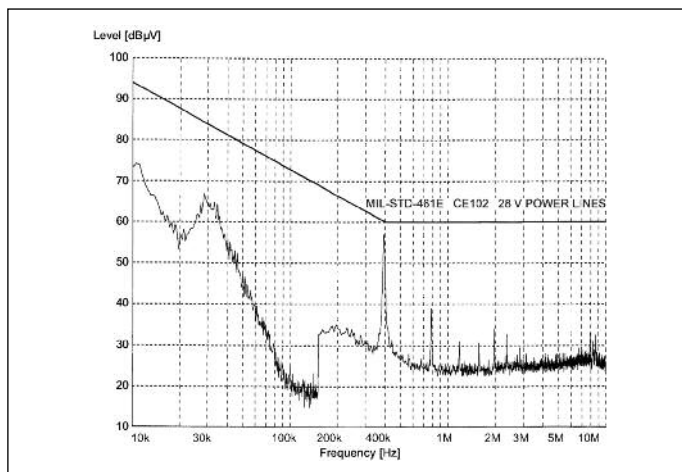

Figure 2 — Conducted Noise; M-FIAM5B and Model V24A12M400B DC-DC converter operating at 28 Vdc, 400 W.

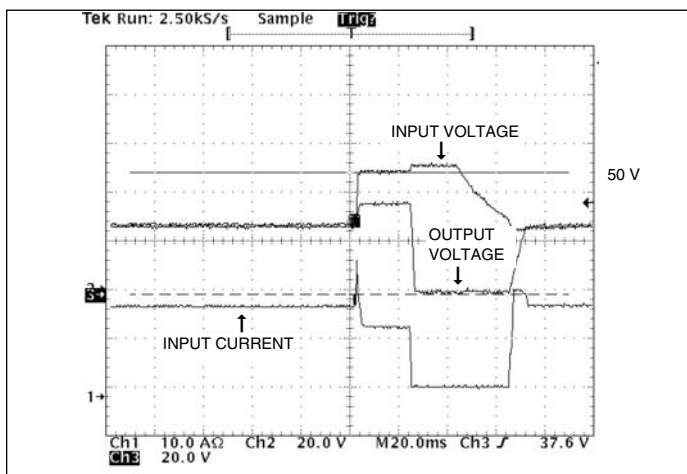

Figure 3 — Transient Immunity: M-FIAM5B output response to an input transient.

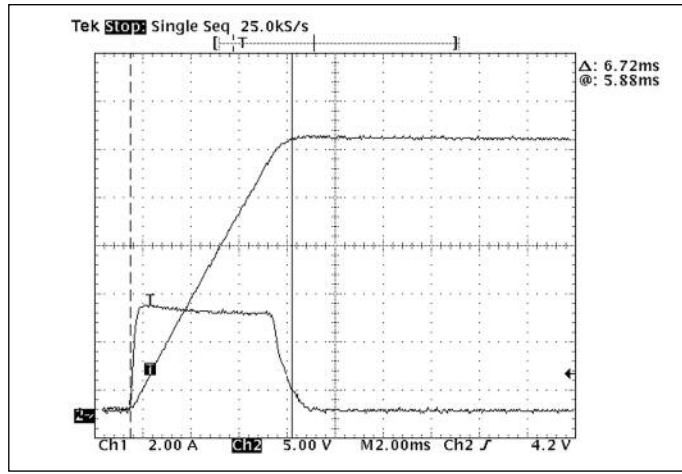

Figure 4— Inrush Limiting: Inrush current with 1000 μ F external capacitance, (C1 in Figure 5)

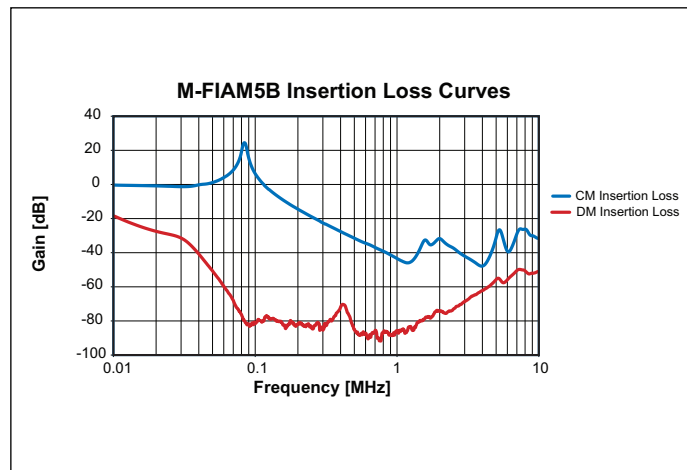

Figure 5 — Insertion Loss

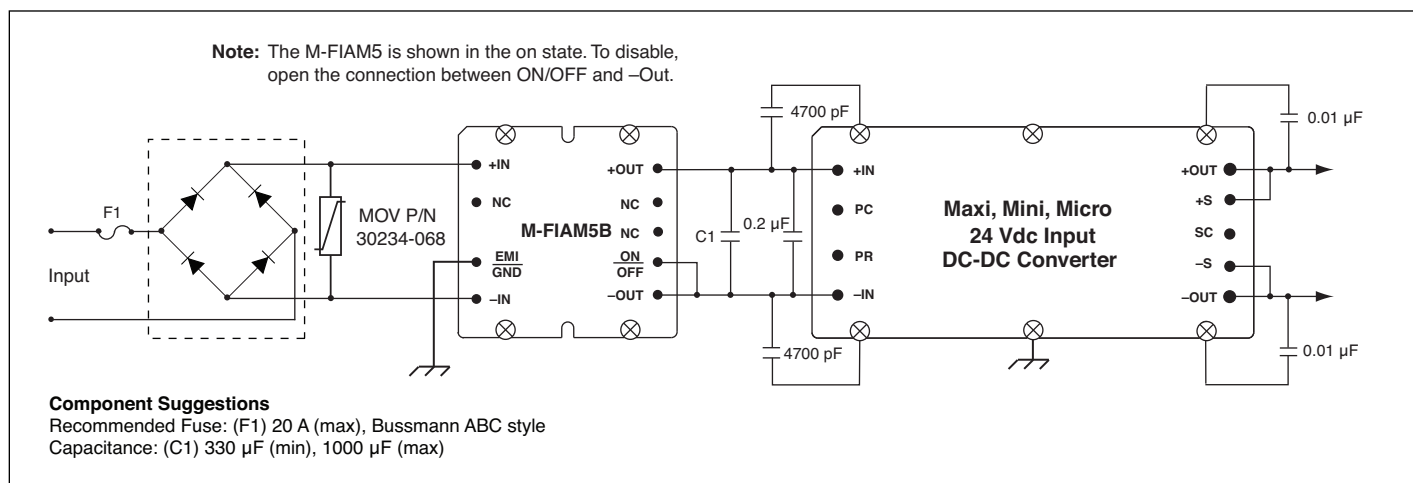

Figure 6—Basic connection diagram with suggested Transient, Surge Protection and Recommended Reverse Polarity Protection.

MECHANICAL DRAWINGS

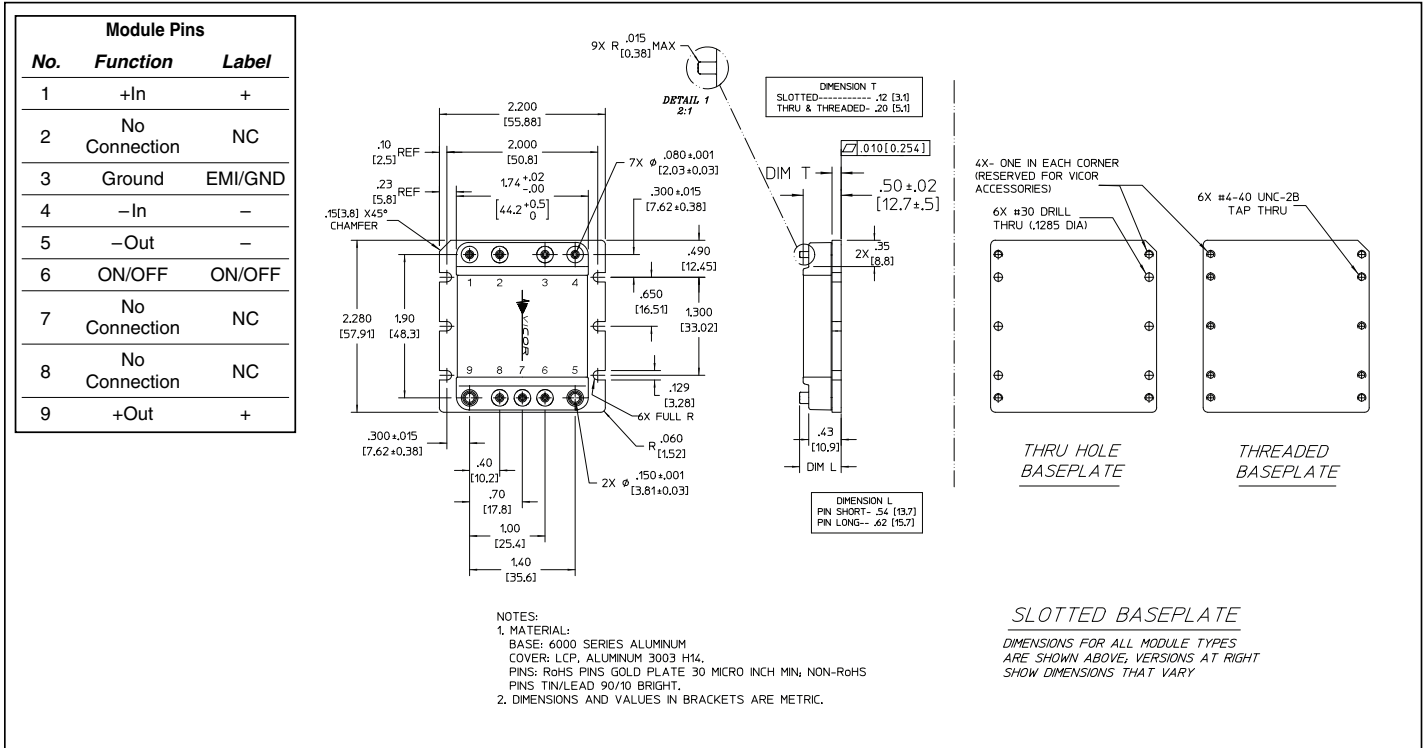

Figure 7 — Mechanical diagram

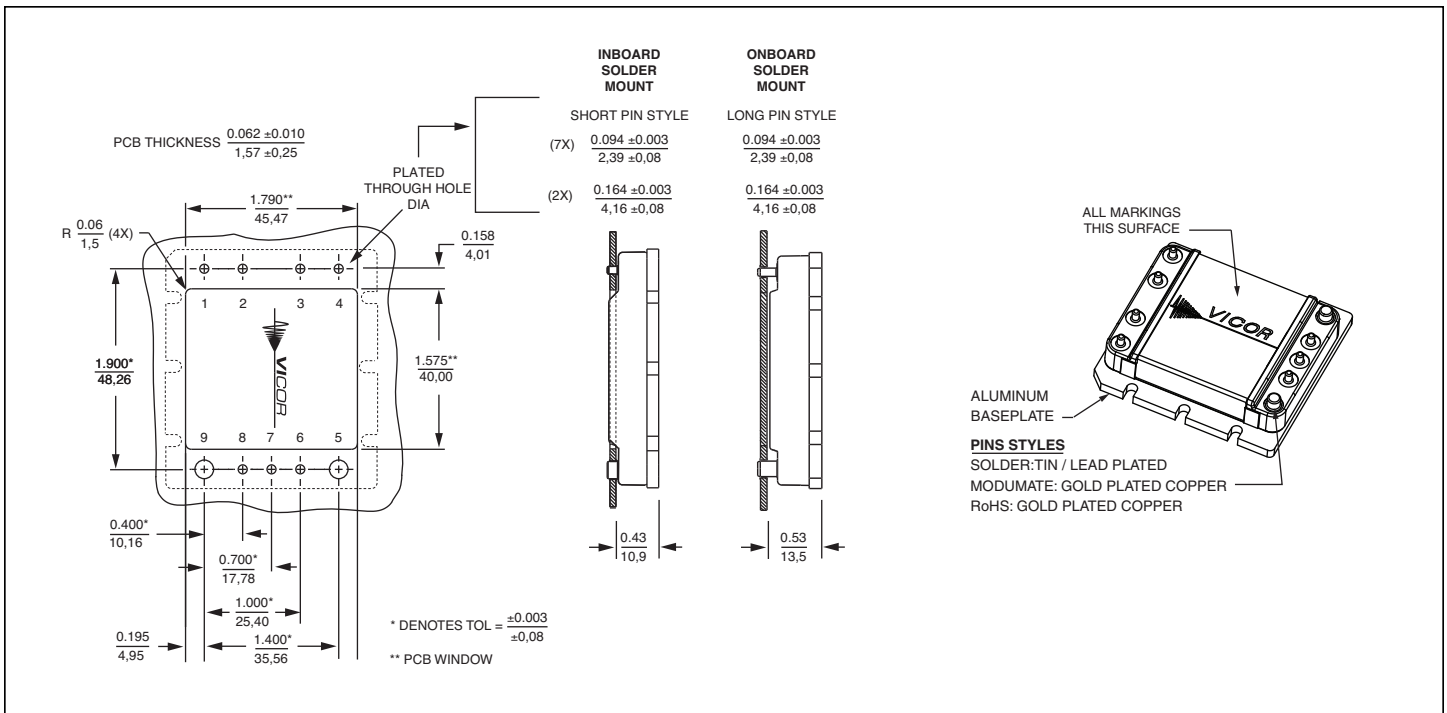

Figure 8 — PCB Mounting Specifications.

Vicor's comprehensive line of power solutions includes high density AC-DC and DC-DC modules and accessory components, fully configurable AC-DC and DC-DC power supplies, and complete custom power systems.

Information furnished by Vicor is believed to be accurate and reliable. However, no responsibility is assumed by Vicor for its use. Vicor makes no representations or warranties with respect to the accuracy or completeness of the contents of this publication. Vicor reserves the right to make changes to any products, specifications, and product descriptions at any time without notice. Information published by Vicor has been checked and is believed to be accurate at the time it was printed; however, Vicor assumes no responsibility for inaccuracies. Testing and other quality controls are used to the extent Vicor deems necessary to support Vicor's product warranty. Except where mandated by government requirements, testing of all parameters of each product is not necessarily performed.

Specifications are subject to change without notice.

Vicor's Standard Terms and Conditions

All sales are subject to Vicor's Standard Terms and Conditions of Sale, which are available on Vicor's webpage or upon request.

Product Warranty

In Vicor's standard terms and conditions of sale, Vicor warrants that its products are free from non-conformity to its Standard Specifications (the "Express Limited Warranty"). This warranty is extended only to the original Buyer for the period expiring two (2) years after the date of shipment and is not transferable.

UNLESS OTHERWISE EXPRESSLY STATED IN A WRITTEN SALES AGREEMENT SIGNED BY A DULY AUTHORIZED VICOR SIGNATORY, VICOR DISCLAIMS ALL REPRESENTATIONS, LIABILITIES, AND WARRANTIES OF ANY KIND (WHETHER ARISING BY IMPLICATION OR BY OPERATION OF LAW) WITH RESPECT TO THE PRODUCTS, INCLUDING, WITHOUT LIMITATION, ANY WARRANTIES OR REPRESENTATIONS AS TO MERCHANTABILITY, FITNESS FOR PARTICULAR PURPOSE, INFRINGEMENT OF ANY PATENT, COPYRIGHT, OR OTHER INTELLECTUAL PROPERTY RIGHT, OR ANY OTHER MATTER.

This warranty does not extend to products subjected to misuse, accident, or improper application, maintenance, or storage. Vicor shall not be liable for collateral or consequential damage. Vicor disclaims any and all liability arising out of the application or use of any product or circuit and assumes no liability for applications assistance or buyer product design. Buyers are responsible for their products and applications using Vicor products and components. Prior to using or distributing any products that include Vicor components, buyers should provide adequate design, testing and operating safeguards.

Vicor will repair or replace defective products in accordance with its own best judgment. For service under this warranty, the buyer must contact Vicor to obtain a Return Material Authorization (RMA) number and shipping instructions. Products returned without prior authorization will be returned to the buyer. The buyer will pay all charges incurred in returning the product to the factory. Vicor will pay all reshipment charges if the product was defective within the terms of this warranty.

Life Support Policy

VICOR'S PRODUCTS ARE NOT AUTHORIZED FOR USE AS CRITICAL COMPONENTS IN LIFE SUPPORT DEVICES OR SYSTEMS WITHOUT THE EXPRESS PRIOR WRITTEN APPROVAL OF THE CHIEF EXECUTIVE OFFICER AND GENERAL COUNSEL OF VICOR CORPORATION. As used herein, life support devices or systems are devices which (a) are intended for surgical implant into the body, or (b) support or sustain life and whose failure to perform when properly used in accordance with instructions for use provided in the labeling can be reasonably expected to result in a significant injury to the user. A critical component is any component in a life support device or system whose failure to perform can be reasonably expected to cause the failure of the life support device or system or to affect its safety or effectiveness. Per Vicor Terms and Conditions of Sale, the user of Vicor products and components in life support applications assumes all risks of such use and indemnifies Vicor against all liability and damages.

Intellectual Property Notice

Vicor and its subsidiaries own Intellectual Property (including issued U.S. and Foreign Patents and pending patent applications) relating to the products described in this data sheet. No license, whether express, implied, or arising by estoppel or otherwise, to any intellectual property rights is granted by this document. Interested parties should contact Vicor's Intellectual Property Department.

Vicor Corporation
25 Frontage Road
Andover, MA, USA 01810
Tel: 800-735-6200
Fax: 978-475-6715

email

Customer Service: custserv@vicorpower.com
Technical Support: apps@vicorpower.com