

3.2 x 1.6 x 1.6 (mm) WiFi Dual Band Chip Antenna (CU325)

Engineering Specification

1. Product Number

H 2 U 8 6 D 1 K 1 P 0 1 0 0



2. Features

- *Stable and reliable performances in both 2.4 and 5 GHz bands
- *Low profile and compact size
- *RoHS compliance
- *SMT processes compatible

3. Applications

- *Wi-Fi CERTIFIED ac applications
- *Wireless communication devices when IEEE802.11 a/b/g/n/ac functions are needed.
- *IoT applications

4. Description

Unictron's CU325 chip antenna is designed for Wi-Fi CERTIFIED ac applications, covering both 2400~2500 MHz & 5150~5850 MHz frequency bands. Fabricated with proprietary design and processes, CU325 shows excellent performance and is fully compatible with SMT processes which can decrease the assembly cost and improve device's quality and consistency.



詠業科技股份有限公司
Unictron Technologies Corporation
Website: www.unictron.com

THIS DRAWINGS AND SPECIFICATIONS ARE THE PROPERTY OF UNICTRON TECHNOLOGIES CORPORATION AND SHALL NOT BE REPRODUCED OR USED AS THE BASIS FOR THE MANUFACTURE OR SALE OF APPARATUS OR DEVICES WITHOUT PERMISSION

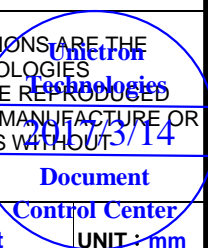

Prepared by : Xenia Designed by : Allen Checked by : Mike Approved by : Herbert UNIT : mm

TITLE : 3.2 x 1.6 x 1.6 (mm) WiFi Dual Band Chip Antenna(CU325) Engineering Specification	DOCUMENT NO.	H2U86D1K1P0100	REV.
			B

5. Layout Guide & Electrical Specifications

5-1. Layout Guide (unit : mm)

Solder Land Pattern:

The solder land pattern (gold marking areas) is shown below. Recommendation on matching circuit will be provided according to customer's installation conditions.

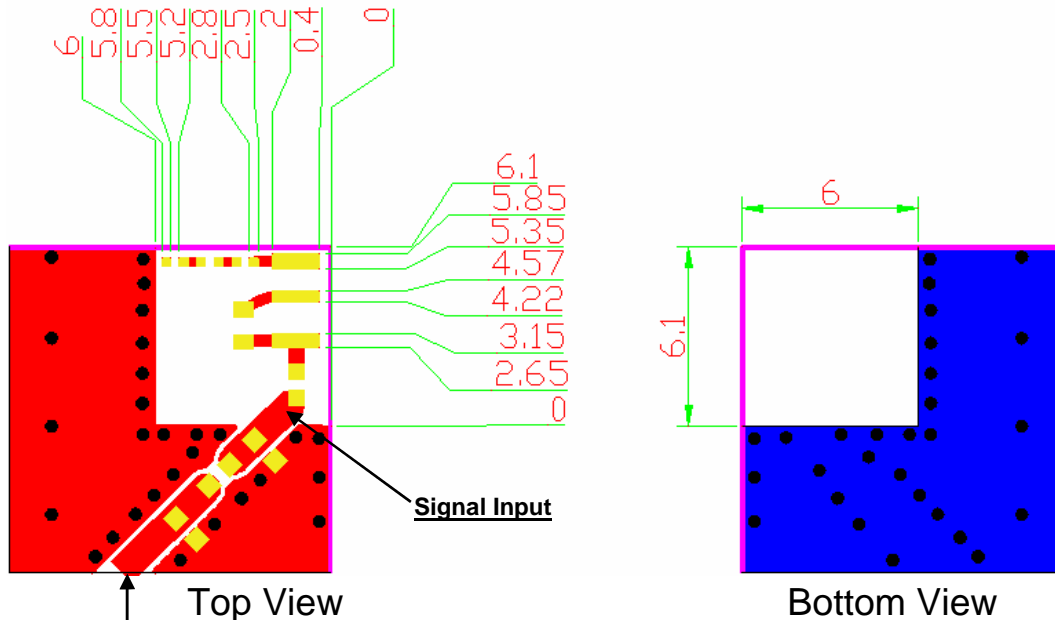

Transmission Line with 50Ω Impedance Characteristic

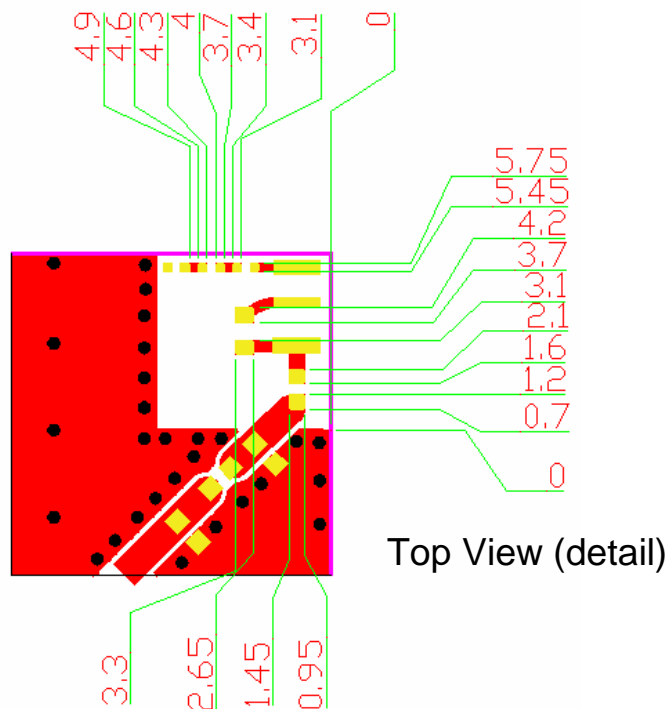

詠業科技股份有限公司
Unictron Technologies Corporation
Website: www.unictron.com

THIS DRAWINGS AND SPECIFICATIONS ARE THE PROPERTY OF UNICTRON TECHNOLOGIES CORPORATION AND SHALL NOT BE REPRODUCED OR USED AS THE BASIS FOR THE MANUFACTURE OR SALE OF APPARATUS OR DEVICES WITHOUT PERMISSION

Prepared by : Xenia

Designed by : Allen

Checked by : Mike

Approved by : Herbert

Document
Control Center
UNIT : mm

TITLE : 3.2 x 1.6 x 1.6 (mm) WiFi Dual Band Chip
Antenna(CU325) Engineering Specification

DOCUMENT
NO.

H2U86D1K1P0100

REV.

B

5-2. Electrical Specifications (Evaluation Board Dimensions: 40 x 40 mm²)

5-2-1. Electrical Table

Characteristics	Specifications	
Outline Dimension (mm)	3.2 x 1.6 x 1.6	
Working Frequency (MHz)	2400 ~ 2500	5150 ~ 5850
Peak Gain (dBi) (typical)**	2.4	1.8
Radiation Efficiency (%) (typical)**	61	56
VSWR (@ center frequency)*	< 2 : 1	< 2.5 : 1
Characteristic Impedance (Ω)	50	
Polarization	Linear Polarization	

*Center frequency means the frequency with the lowest value in return loss of the chip antenna on the evaluation board.

**A typical value is for reference only, not guaranteed.

5-2-3. Frequency vs. V.S.W.R. and Total Radiation Gain

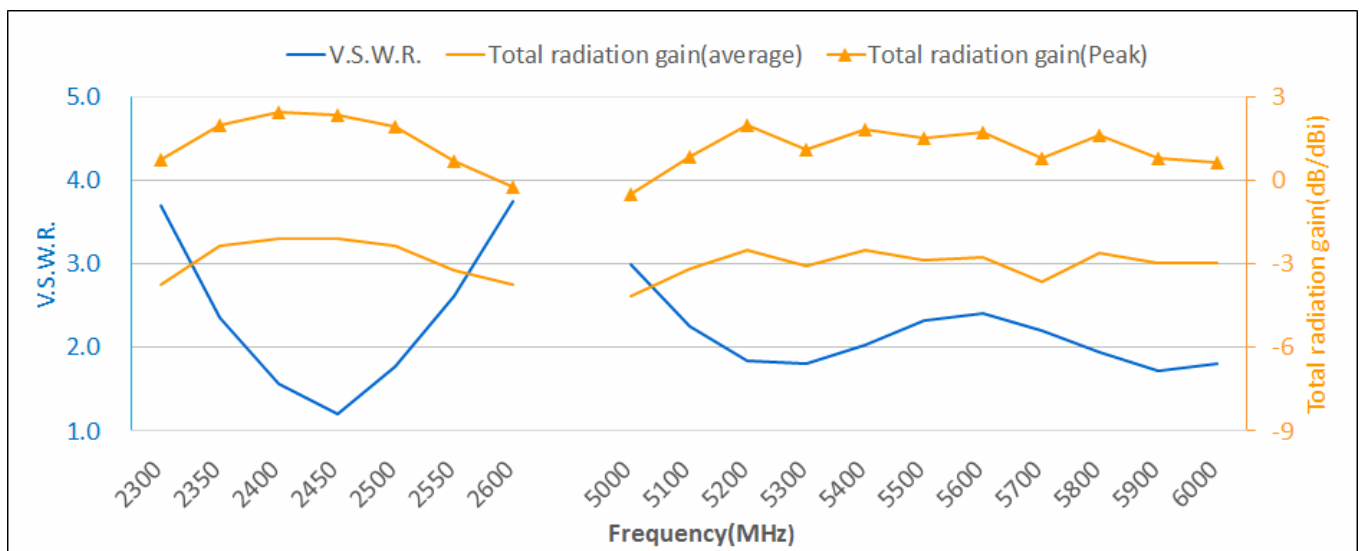

詠業科技股份有限公司
Unictron Technologies Corporation
Website: www.unictron.com

THIS DRAWINGS AND SPECIFICATIONS ARE THE PROPERTY OF UNICTRON TECHNOLOGIES CORPORATION AND SHALL NOT BE REPRODUCED OR USED AS THE BASIS FOR THE MANUFACTURE OR SALE OF APPARATUS OR DEVICES WITHOUT PERMISSION

Prepared by : Xenia

Designed by : Allen

Checked by : Mike

Approved by : Herbert

Control Center UNIT : mm

TITLE : 3.2 x 1.6 x 1.6 (mm) WiFi Dual Band Chip Antenna(CU325) Engineering Specification

DOCUMENT NO.

H2U86D1K1P0100

REV.

B

6. Outline Dimensions of Antenna & Evaluation Board (unit: mm)

6-1. Antenna Dimensions

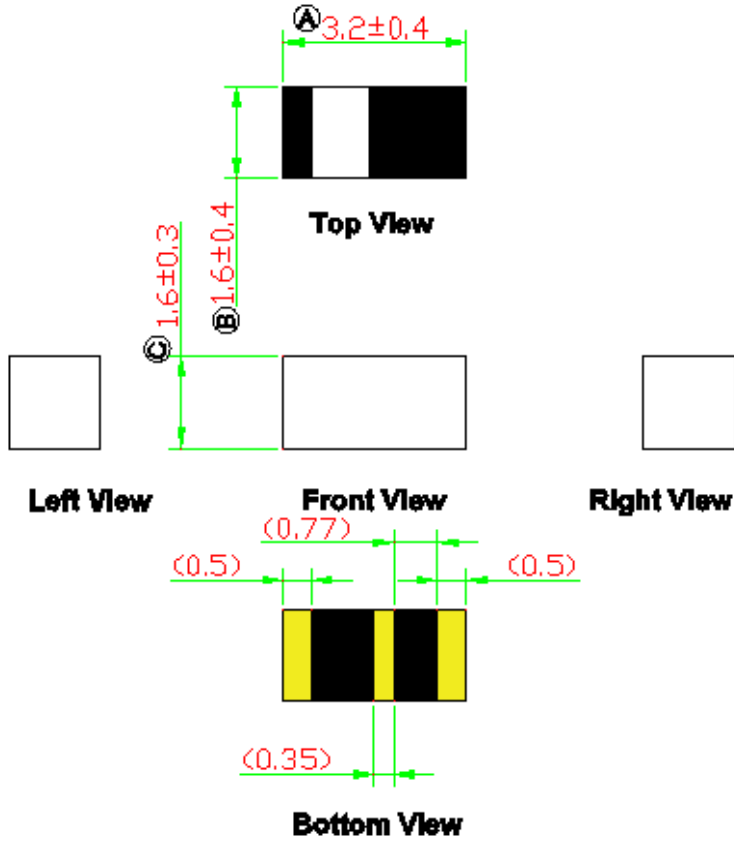

NOTE:

1. All materials are RoHS compliant.
2. "A~C" Critical Dimensions.
3. "()" Reference Dimensions.

PIN Definition

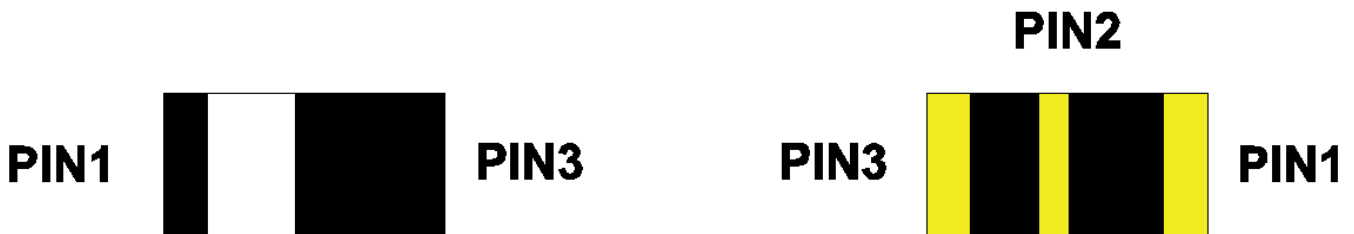

PIN	1	2	3
Soldering PAD	Signal	Tuning	Tuning



詠業科技股份有限公司
Unictron Technologies Corporation
Website: www.unictron.com

THIS DRAWINGS AND SPECIFICATIONS ARE THE PROPERTY OF UNICTRON TECHNOLOGIES CORPORATION AND SHALL NOT BE REPRODUCED OR USED AS THE BASIS FOR THE MANUFACTURE OR SALE OF APPARATUS OR DEVICES WITHOUT PERMISSION

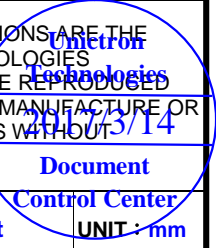

Prepared by : Xenia Designed by : Allen Checked by : Mike Approved by : Herbert UNIT : mm

TITLE : 3.2 x 1.6 x 1.6 (mm) WiFi Dual Band Chip Antenna(CU325) Engineering Specification	DOCUMENT NO.	H2U86D1K1P0100	REV.
			B

6-2. Evaluation Board with Antenna

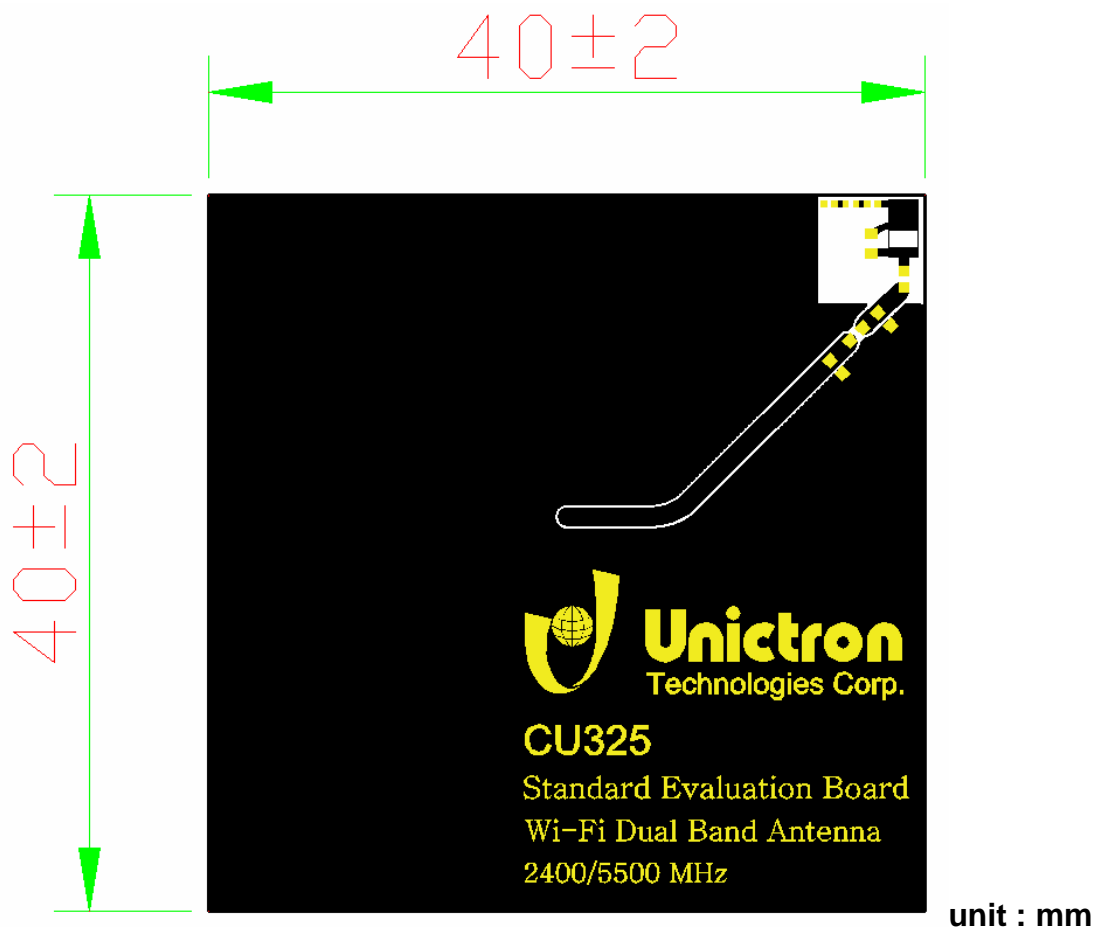

詠業科技股份有限公司
 Unictron Technologies Corporation
 Website:www.unictron.com

THIS DRAWINGS AND SPECIFICATIONS ARE THE PROPERTY OF UNICTRON TECHNOLOGIES CORPORATION AND SHALL NOT BE REPRODUCED OR USED AS THE BASIS FOR THE MANUFACTURE OR SALE OF APPARATUS OR DEVICES WITHOUT PERMISSION

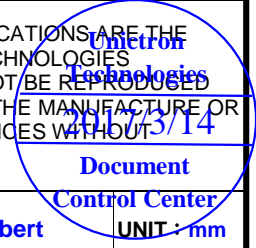

Prepared by : Xenia	Designed by : Allen	Checked by : Mike	Approved by : Herbert	UNIT : mm
TITLE : 3.2 x 1.6 x 1.6 (mm) WiFi Dual Band Chip Antenna(CU325) Engineering Specification	DOCUMENT NO.	H2U86D1K1P0100	REV.	
			B	

7. 3D Radiation Gain Pattern (with 40 x 40 mm² Evaluation Board)

7-1. 2400~2500 MHz Band

7-1-1. 3D Radiation Gain Pattern @ 2450 MHz (unit: dBi)

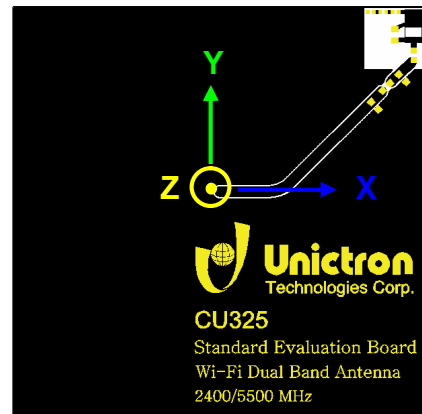
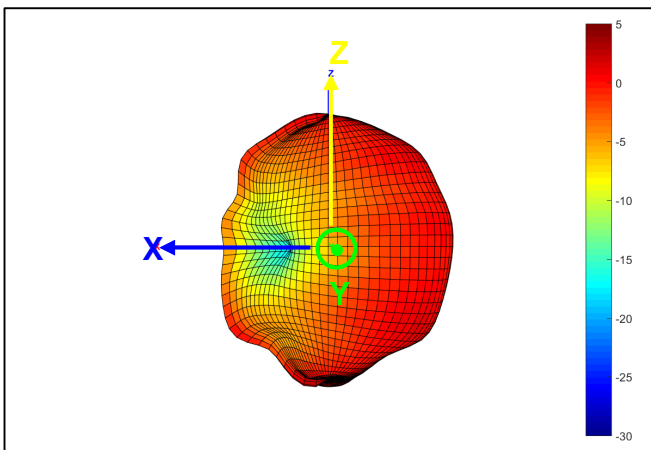
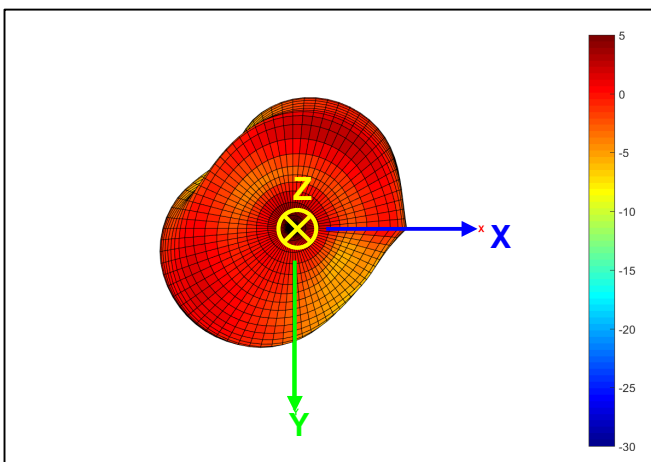
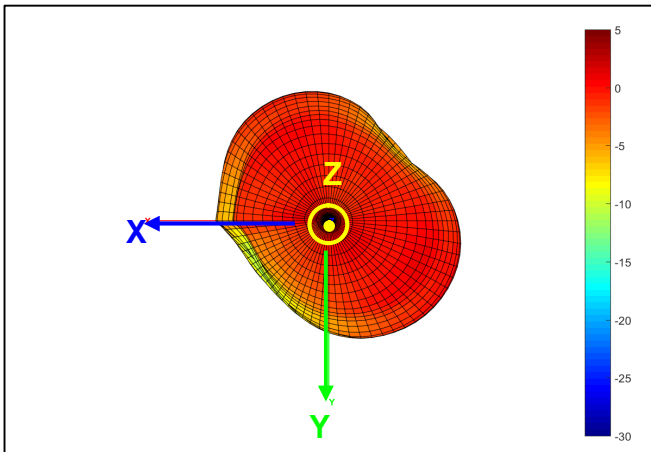

詠業科技股份有限公司
 Unictron Technologies Corporation
 Website: www.unictron.com

THIS DRAWINGS AND SPECIFICATIONS ARE THE PROPERTY OF UNICTRON TECHNOLOGIES CORPORATION AND SHALL NOT BE REPRODUCED OR USED AS THE BASIS FOR THE MANUFACTURE OR SALE OF APPARATUS OR DEVICES WITHOUT PERMISSION

Unictron Technologies
 2017/5/14
 Document
 Control Center
 UNIT : mm

Prepared by : Xenia Designed by : Allen Checked by : Mike Approved by : Herbert

TITLE : 3.2 x 1.6 x 1.6 (mm) WiFi Dual Band Chip Antenna(CU325) Engineering Specification	DOCUMENT NO.	H2U86D1K1P0100	REV.
			B

7-2. 5150~5850 MHz Band

7-2-1. 3D Radiation Gain Pattern @ 5150 MHz (unit: dBi)

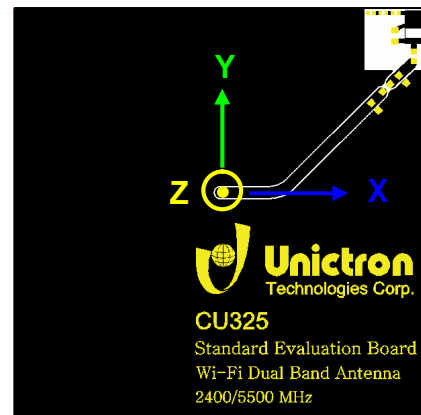
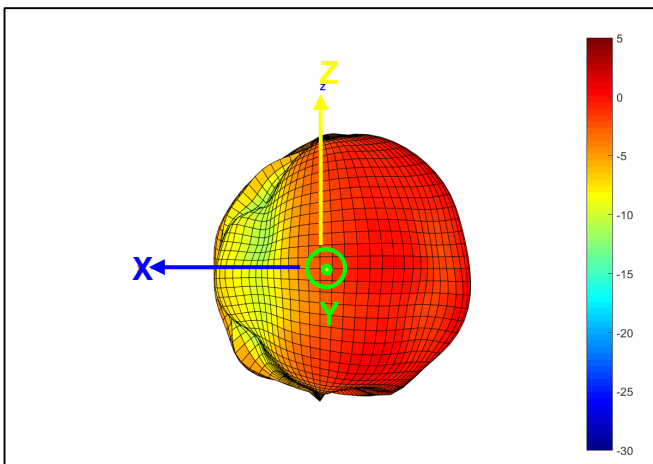
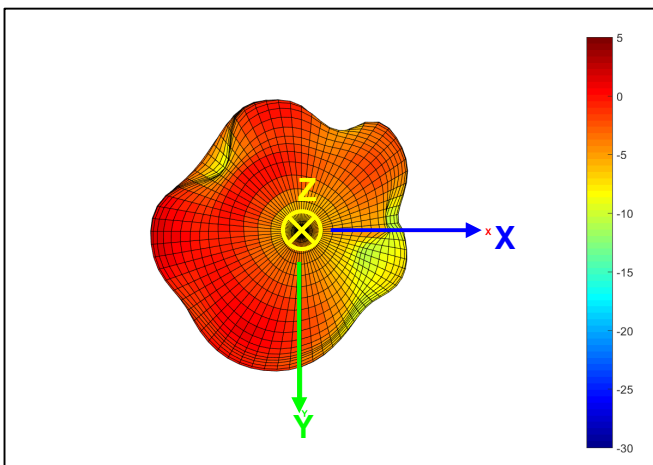
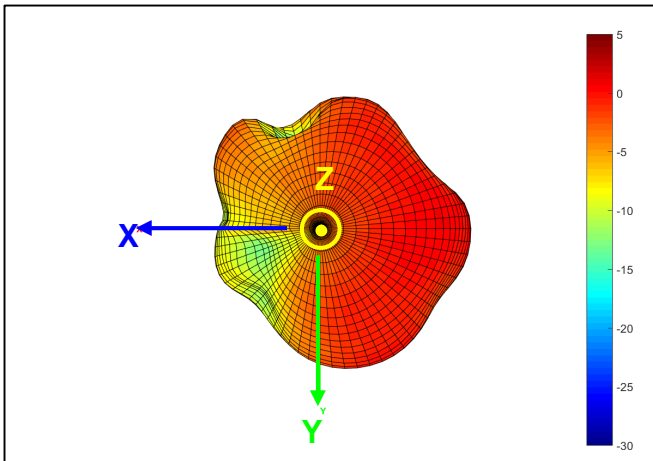

詠業科技股份有限公司
Unictron Technologies Corporation
Website: www.unictron.com

THIS DRAWINGS AND SPECIFICATIONS ARE THE PROPERTY OF UNICTRON TECHNOLOGIES CORPORATION AND SHALL NOT BE REPRODUCED OR USED AS THE BASIS FOR THE MANUFACTURE OR SALE OF APPARATUS OR DEVICES WITHOUT PERMISSION

Unictron Technologies
2017/5/14
Document
Control Center
UNIT : mm

Prepared by : Xenia Designed by : Allen Checked by : Mike Approved by : Herbert

TITLE : 3.2 x 1.6 x 1.6 (mm) WiFi Dual Band Chip Antenna(CU325) Engineering Specification

DOCUMENT NO.

H2U86D1K1P0100

REV.
B

7-2-2. 3D Radiation Gain Pattern @ 5550 MHz (unit: dBi)

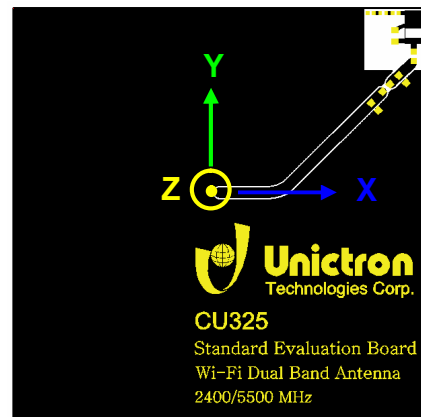
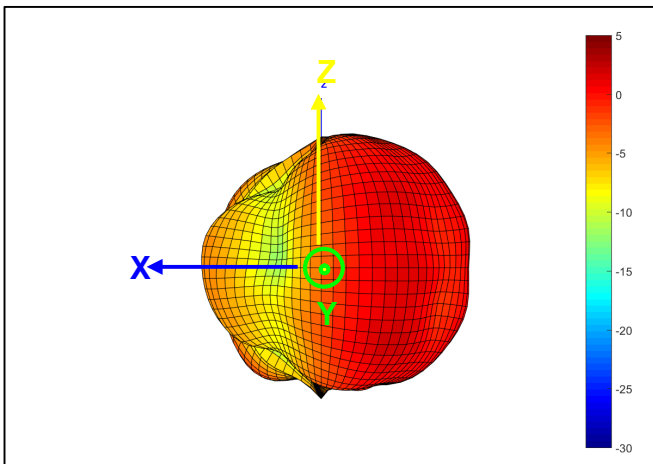
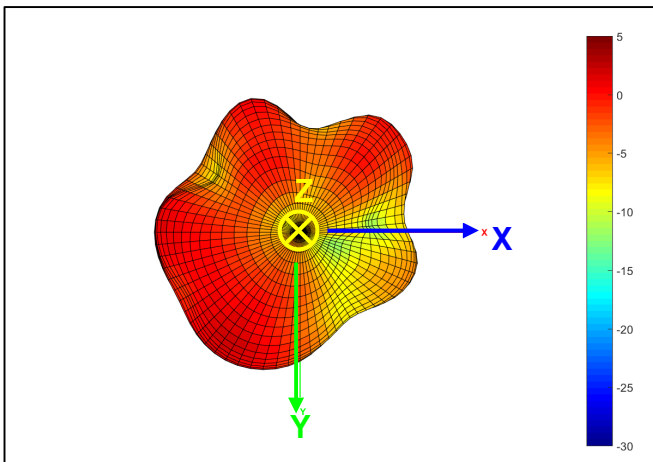
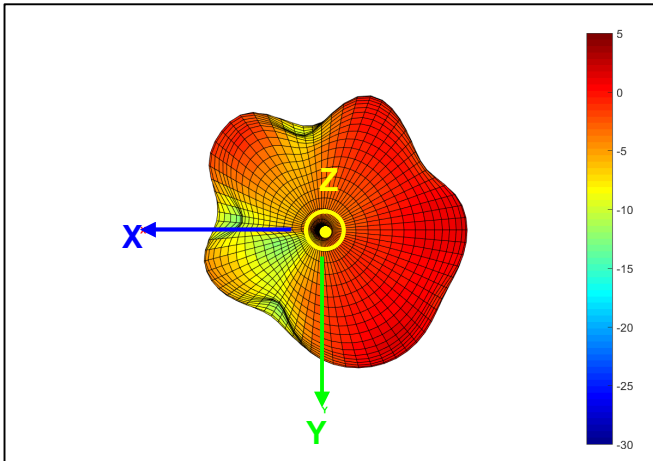

詠業科技股份有限公司
 Unictron Technologies Corporation
 Website: www.unictron.com

THIS DRAWINGS AND SPECIFICATIONS ARE THE PROPERTY OF UNICTRON TECHNOLOGIES CORPORATION AND SHALL NOT BE REPRODUCED OR USED AS THE BASIS FOR THE MANUFACTURE OR SALE OF APPARATUS OR DEVICES WITHOUT PERMISSION

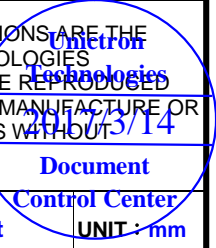

Prepared by : Xenia Designed by : Allen Checked by : Mike Approved by : Herbert UNIT : mm

TITLE : 3.2 x 1.6 x 1.6 (mm) WiFi Dual Band Chip Antenna(CU325) Engineering Specification	DOCUMENT NO.	H2U86D1K1P0100	REV.
			B

7-2-3. 3D Radiation Gain Pattern @ 5850 MHz (unit: dBi)

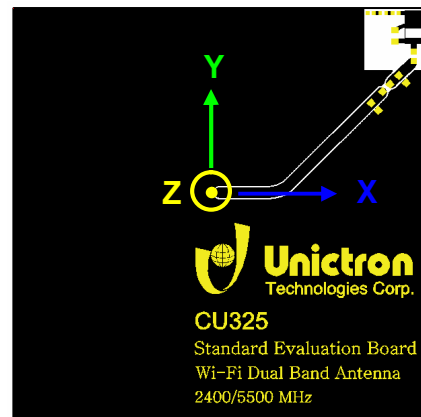
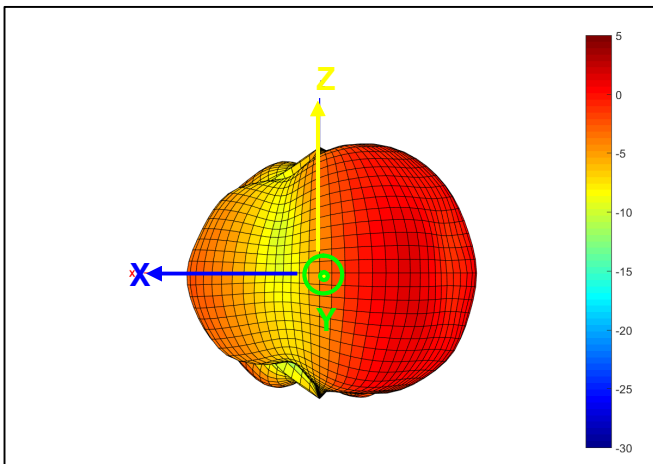
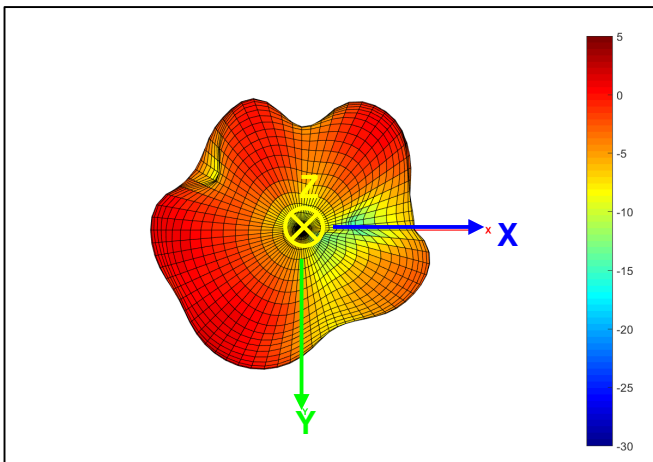
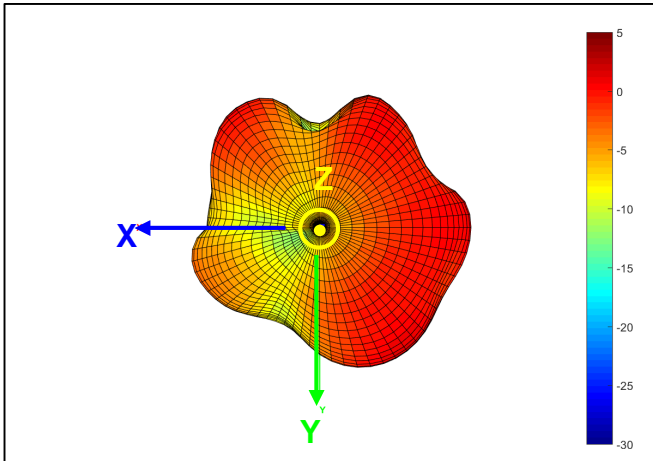

詠業科技股份有限公司
 Unictron Technologies Corporation
 Website: www.unictron.com

THIS DRAWINGS AND SPECIFICATIONS ARE THE PROPERTY OF UNICTRON TECHNOLOGIES CORPORATION AND SHALL NOT BE REPRODUCED OR USED AS THE BASIS FOR THE MANUFACTURE OR SALE OF APPARATUS OR DEVICES WITHOUT PERMISSION

Unictron Technologies
 2017/3/14
 Document
 Control Center
 UNIT : mm

Prepared by : Xenia Designed by : Allen Checked by : Mike Approved by : Herbert

TITLE : 3.2 x 1.6 x 1.6 (mm) WiFi Dual Band Chip Antenna(CU325) Engineering Specification

DOCUMENT NO.

H2U86D1K1P0100

REV.
 B

8. Frequency tuning and Matching circuit

8-1. Chip antenna tuning scenario :

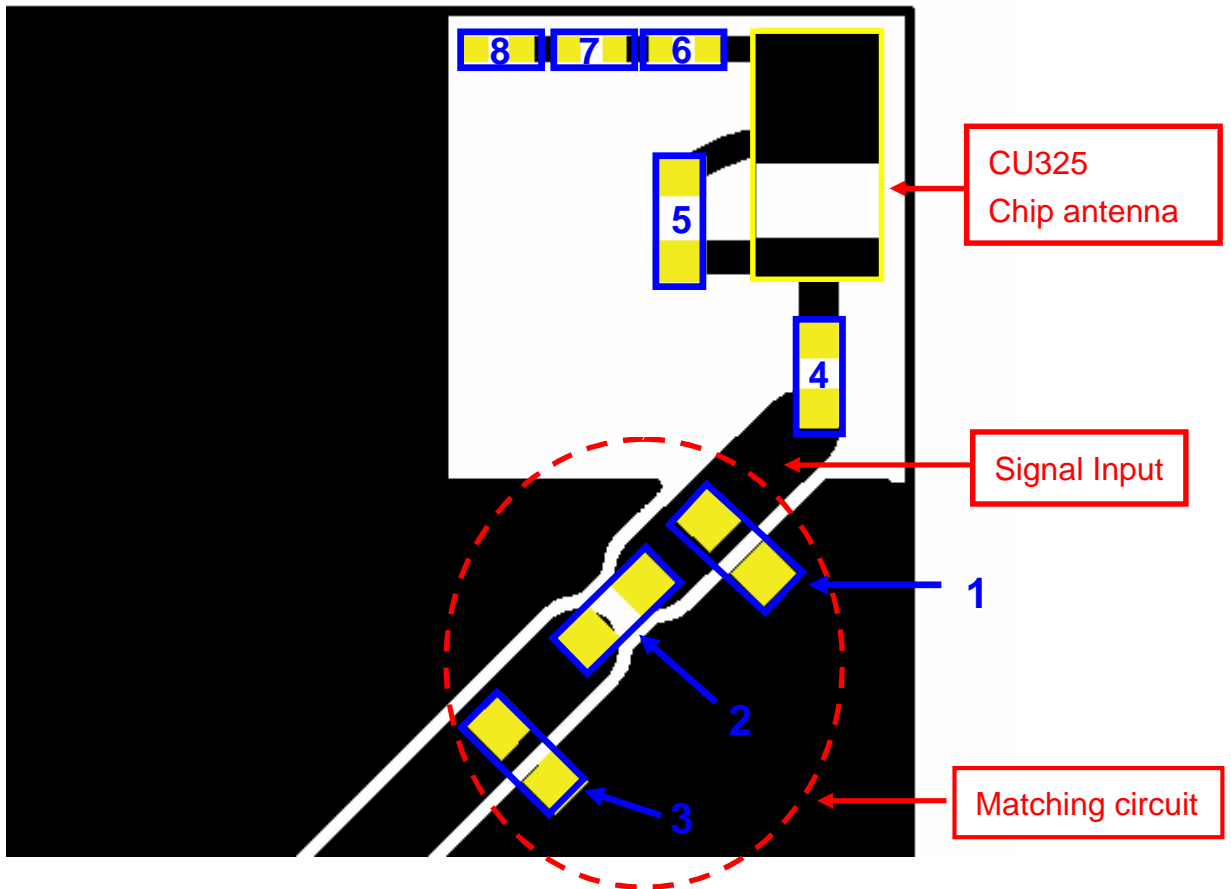

詠業科技股份有限公司
Unictron Technologies Corporation
Website: www.unictron.com

THIS DRAWINGS AND SPECIFICATIONS ARE THE PROPERTY OF UNICTRON TECHNOLOGIES CORPORATION AND SHALL NOT BE REPRODUCED OR USED AS THE BASIS FOR THE MANUFACTURE OR SALE OF APPARATUS OR DEVICES WITHOUT PERMISSION

Unictron Technologies
2017/5/14
Document
Control Center
UNIT : mm

Prepared by : Xenia

Designed by : Allen

Checked by : Mike

Approved by : Herbert

TITLE : 3.2 x 1.6 x 1.6 (mm) WiFi Dual Band Chip Antenna(CU325) Engineering Specification

DOCUMENT NO.

H2U86D1K1P0100

REV.
B

8-2. Matching circuit :

With the following recommended values of matching and tuning components, the center frequencies will be about 2442 MHz in low band & 5500 MHz in high band at our standard 40x40 mm² evaluation board. However, these are reference values, may need to be changed when the circuit boards or part vendors are different.

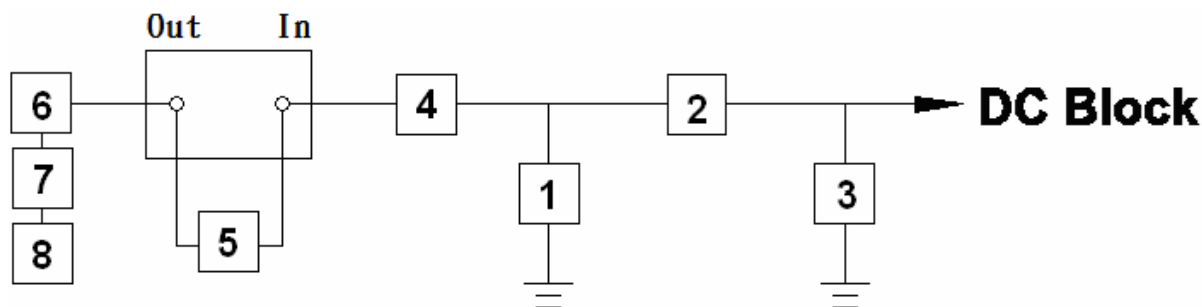

System Matching Circuit Component			
Location	Description	Vendor	Tolerance
1	0.3 pF, (0402)	MURATA	±0.05 pF
2	15 pF, (0402)	MURATA	±5%
3	2.2 nH, (0402)	MURATA	±0.1nH
4 Fine tuning element	1.5 nH, (0402)	MURATA	±0.1nH
*5 Fine tuning element	7.5 nH, (0402)	MURATA	±2%
6 Fine tuning element	0 Ω, (0201)	-	-
7 Fine tuning element	N/C	-	-
8 Fine tuning element	N/C	-	-

*For fine tuning element 5, we highly recommend using Murata LQG15WZ_G02# series inductor which has 2% tolerance in inductance and high Q factor. In general, the inductance of this inductor that can be used for fine tuning element 5 is 5nH ~ 10nH in most circumstances.



詠業科技股份有限公司
Unictron Technologies Corporation
Website:www.unictron.com

THIS DRAWINGS AND SPECIFICATIONS ARE THE PROPERTY OF UNICTRON TECHNOLOGIES CORPORATION AND SHALL NOT BE REPRODUCED OR USED AS THE BASIS FOR THE MANUFACTURE OR SALE OF APPARATUS OR DEVICES WITHOUT PERMISSION

Prepared by : Xenia

Designed by : Allen

Checked by : Mike

Approved by : Herbert

Control Center
UNIT : mm

TITLE : 3.2 x 1.6 x 1.6 (mm) WiFi Dual Band Chip Antenna(CU325) Engineering Specification

DOCUMENT NO.

H2U86D1K1P0100

REV.

B

9. Soldering Conditions

Typical Soldering Profile for Lead-free Process

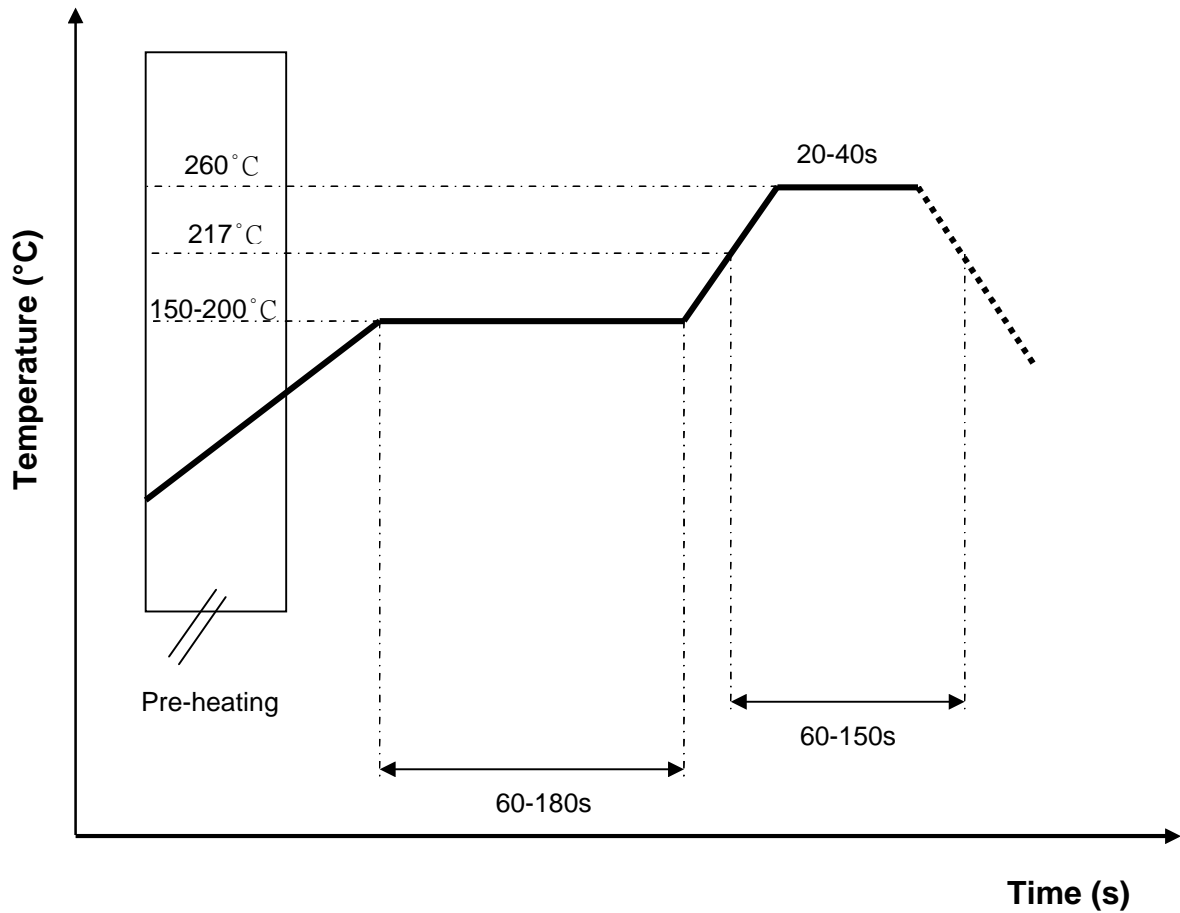

詠業科技股份有限公司
Unictron Technologies Corporation
Website: www.unictron.com

THIS DRAWINGS AND SPECIFICATIONS ARE THE PROPERTY OF UNICTRON TECHNOLOGIES CORPORATION AND SHALL NOT BE REPRODUCED OR USED AS THE BASIS FOR THE MANUFACTURE OR SALE OF APPARATUS OR DEVICES WITHOUT PERMISSION

Unictron Technologies
2017/3/14
Document
Control Center
UNIT : mm

Prepared by : Xenia

Designed by : Allen

Checked by : Mike

Approved by : Herbert

TITLE : 3.2 x 1.6 x 1.6 (mm) WiFi Dual Band Chip
Antenna(CU325) Engineering Specification

DOCUMENT
NO.

H2U86D1K1P0100

REV.
B

10. Packing

- (1) Quantity/Reel: 2000pcs/Reel
- (2) Plastic tape: Black conductive polystyrene

a. Tape Drawing

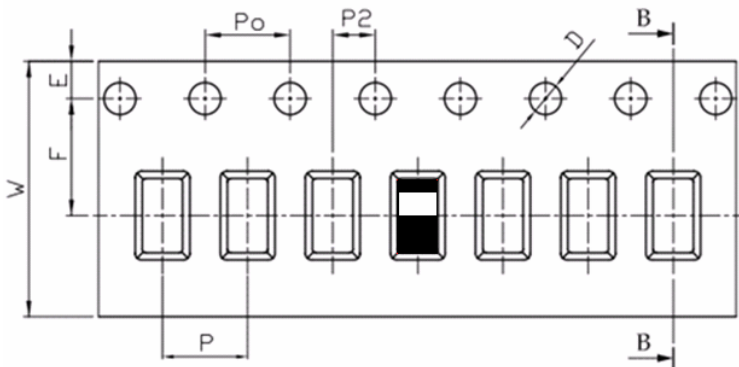

b. Tape Dimensions (unit: mm)

Feature	Specifications	Tolerances
W	12.00	±0.30
P	4.00	±0.10
E	1.75	±0.10
F	5.50	±0.10
P2	2.00	±0.10
D	1.50	+0.10 -0.00
P0	4.00	±0.10
10P0	40.00	±0.20

11. Operating & Storage Conditions

11-1. Operating

- (1) Maximum Input Power: 2 W
- (2) Operating Temperature: -40°C to 85°C
- (3) Relative Humidity: 10% to 70%

11-2. Storage (sealed)

- (1) Storage Temperature: -5°C to 40°C
- (2) Relative Humidity: 20% to 70%
- (3) Shelf Life: 1 year

11-3. Storage (unsealed)

Meet the criteria of J-STD-033 MSL2a

11-4. Storage (After mounted on customer's PCB with SMT process)

- (1) Storage Temperature: -40°C to 85°C
- (2) Relative Humidity: 10% to 70%



詠業科技股份有限公司
Unictron Technologies Corporation
Website: www.unictron.com

THIS DRAWINGS AND SPECIFICATIONS ARE THE PROPERTY OF UNICTRON TECHNOLOGIES CORPORATION AND SHALL NOT BE REPRODUCED OR USED AS THE BASIS FOR THE MANUFACTURE OR SALE OF APPARATUS OR DEVICES WITHOUT PERMISSION

Unictron Technologies
2017/3/14
Document
Control Center
UNIT : mm

Prepared by : Xenia

Designed by : Allen

Checked by : Mike

Approved by : Herbert

TITLE : 3.2 x 1.6 x 1.6 (mm) WiFi Dual Band Chip
Antenna(CU325) Engineering Specification

DOCUMENT
NO.

H2U86D1K1P0100

REV.

B

12. Notice

(1) Installation Guide:

Please refer to Unictron's application note "General guidelines for the installation of Unictron's chip antennas" for further information.

(2) All specifications are subject to change without notice.



詠業科技股份有限公司
 Unictron Technologies Corporation
 Website:www.unictron.com

THIS DRAWINGS AND SPECIFICATIONS ARE THE PROPERTY OF UNICTRON TECHNOLOGIES CORPORATION AND SHALL NOT BE REPRODUCED OR USED AS THE BASIS FOR THE MANUFACTURE OR SALE OF APPARATUS OR DEVICES WITHOUT PERMISSION

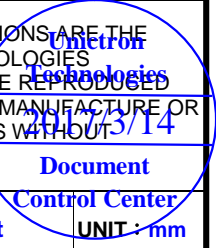

Prepared by : Xenia Designed by : Allen Checked by : Mike Approved by : Herbert

UNIT : mm

TITLE : 3.2 x 1.6 x 1.6 (mm) WiFi Dual Band Chip Antenna(CU325) Engineering Specification

DOCUMENT NO.

H2U86D1K1P0100

REV.

B