

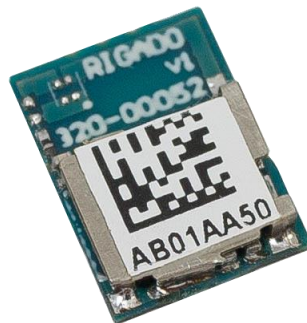

BMD-350 Data Sheet

Version 2.0



1 Contents

1	Contents.....	i
2	Introduction.....	1
3	Features	1
4	Applications.....	1
5	Ordering Information	2
6	Block Diagram	2
7	Quick Specifications.....	3
8	Pin Descriptions – BMD-350	4
8.1	Pin-out	4
8.2	Pin Descriptions	4
9	Electrical Specifications.....	6
9.1	Absolute Maximum Ratings	6
9.2	Operating Conditions.....	6
9.3	General Purpose I/O	6
9.4	Peripheral pin assignments	7
9.5	Module RESET.....	7
9.6	Debug & Programming.....	7
9.7	Clocks.....	7
9.7.1	32.768kHz Crystal (LFXO)	7
9.7.2	32.768kHz Clock Source Comparison	8
10	Firmware.....	9
10.1	Factory Image.....	9
10.1.1	Firmware Version ‘AA’	9
10.1.2	Firmware Version ‘AB’	9
10.1.3	Firmware Version ‘AC’	9
10.1.4	Firmware Version ‘AD’	10
10.1.5	Firmware Version ‘AE’	10
10.2	Module Programming and Read-Back Protection	10
10.3	SoftDevices.....	11
10.3.1	S132	11
10.3.2	S212	11
10.3.3	S332	11
10.4	MAC Address Info.....	12
11	Mechanical Data	13
11.1	Dimensions.....	13
11.2	Recommended PCB Land Pads	13
11.3	Module Marking.....	14
12	RF Design Notes.....	15
12.1	Recommended RF Layout & Ground Plane	15
12.2	Mechanical Enclosure	15
12.3	Antenna Patterns	16
12.3.1	X-Y Plane	16
12.3.2	Y-Z Plane.....	17
12.3.3	Z-X Plane.....	17

13	BMD-350-EVAL Development Kit.....	18
14	Bluetooth Qualification.....	18
15	Regulatory Agency Approvals	19
15.1	United States (FCC):	19
15.1.1	Labeling & User Information Requirements.....	19
15.1.2	RF Exposure	19
15.2	Canada (IC)	20
15.2.1	Labeling & User Information Requirements.....	20
15.2.2	RF Exposure	21
15.3	Europe (CE).....	21
15.3.1	Labeling & User Information Requirements.....	21
15.4	Japan (MIC).....	21
15.5	Australia / New Zealand (RCM)	22
15.6.	Brazil (ANATEL)	22
15.7.	Eurasia (EAC).....	23
15.8.	Mexico (IFETEL).....	23
15.9.	China (SRRC)	23
15.10	Environmental	24
15.10.1	RoHS	24
15.10.2	REACH	24
15.10.3	California Proposition 65 (P65).....	24
16	Solder Reflow Temperature-Time Profile.....	25
16.1	Moisture Sensitivity Level	25
17	Packaging and Labeling	25
17.1	Carrier Tape Dimensions.....	25
17.2	Reel Packaging	26
17.3	Packaging Label	26
18	Cautions.....	27
19	Life Support and other High-Risk Use Warning.....	27
20	Related Documents	28
21	Contact Information	28
22	List of Tables.....	29
23	List of Figures.....	29
24	Document History.....	30

2 Introduction

The BMD-350 from Rigado is a powerful, highly flexible, ultra-low power Bluetooth Low Energy module based on the nRF52832 SoC from Nordic Semiconductor. With an ARM® Cortex™ M4F CPU, embedded 2.4GHz transceiver, and integrated antenna, the BMD-350 provides a complete RF solution with no additional RF design, allowing faster time to market. Providing full use of the nRF52832's capabilities and peripherals, the BMD-350 can power the most demanding applications, all while simplifying designs and reducing BOM costs. With an internal DC-DC converter and intelligent power control, the BMD-350 provides class-leading power efficiency, enabling ultra-low power sensitive applications. Regulatory pre-approvals reduce the burden to enter the market.

3 Features

- Based on the Nordic nRF52832 SoC
- Bluetooth 5 2M LE, Advertising Extensions, CSA #2
- Complete RF solution with integrated DC-DC converter
- Nordic SoftDevice ready
- Over-the-Air (OTA) firmware updates
- No external components required
- ARM® Cortex™-M4F 32-bit processor
- 512kB embedded flash memory
- 64kB RAM
- -40°C to +85°C Temperature Range
- 32 General Purpose I/O Pins
- 12-bit/200KSPS ADC
- Serial Wire Debug (SWD)
- Three SPI Master/Slave (8 Mbps)
- Two 2-wire Master/Slave (I2C compatible)
- UART (w/ CTS/RTS and DMA)
- I2S audio interface
- Low power comparator
- Temperature sensor
- Random Number Generator
- 20 channel CPU independent Programmable Peripheral Interconnect (PPI)
- Quadrature Demodulator (QDEC)
- 128-bit AES HW encryption
- 5 x 32bit, 3 x 24bit Real Timer Counters (RTC)
- NFC-A tag interface for OOB pairing
- Dimensions: 8.7 x 6.4 x 1.5mm
- USA (FCC): 2AA9B05
- Canada (IC): 12208A-05
- Japan (MIC): 210-10894

4 Applications

- Beacons – iBeacon™, Eddystone, AltBeacon, etc.
- Low-Power Sensors
- Fitness devices
- Wearables
- Climate Control
- Lighting
- Safety and Security
- Home Appliances
- Access Control
- Internet of Things
- Home Health Care
- Advanced Remote Controls
- Smart Energy Management
- Low-Power Sensor Networks
- Interactive Entertainment
- Key Fobs
- Environmental Monitoring
- Hotel Automation
- Office Automation

5 Ordering Information

Part Number	Description
BMD-350-A-R	BMD-350 module, Rev A, Tape & Reel, 1000-piece multiples
BMD-350-EVAL	BMD-350 Evaluation Kit w/ SEGGER J-Link-OB debug probe

Table 1 – Ordering Information

6 Block Diagram

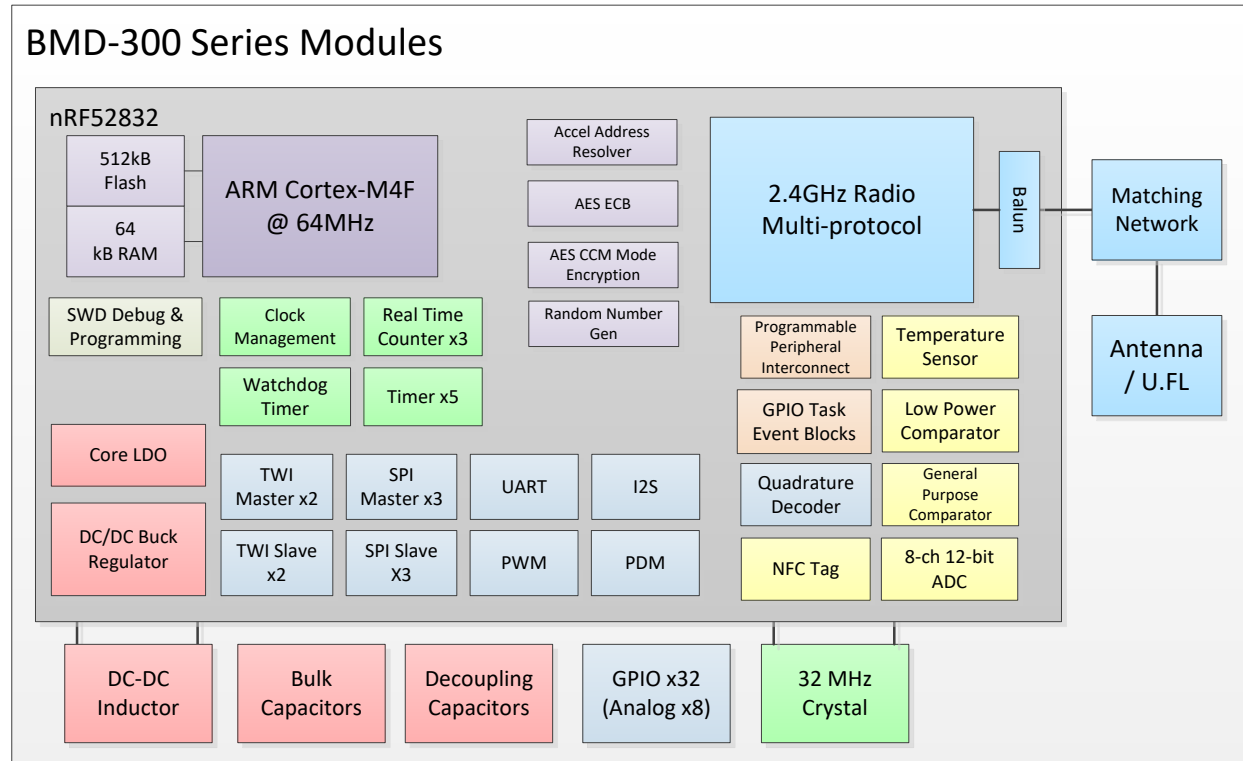

Figure 1 – Block Diagram

7 Quick Specifications

Bluetooth		
Version	5.0, Concurrent Central & Peripheral (S132), 2M LE, Advertising Extensions, CSA #2	
Security	AES-128	
LE connections	Concurrent central, observer, peripheral, and broadcaster roles with up to twenty concurrent connections along with one Observer and one Broadcaster (S132)	
Radio		
Frequency	2.360GHz to 2.500GHz	
Modulations	GFSK at 1 Mbps, 2 Mbps data rates	
Transmit power	+4 dBm maximum	
Receiver sensitivity	-96 dBm (BLE mode)	
Antenna	Ceramic Chip (1dBi peak)	
Current Consumption		
TX only @ +4 dBm, 0 dBm @ 3V, DCDC enabled	7.5 mA, 5.3 mA	
TX only @ +4 dBm, 0 dBm	16.6 mA, 11.6 mA	
RX only @ 1 Mbps @ 3V, DCDC enabled	5.4 mA	
RX only @ 1 Mbps	11.7 mA	
CPU @ 64MHz from flash, from RAM	7.4 mA, 6.7 mA	
CPU @ 64MHz from flash, from RAM @ 3V, DCDC	3.7 mA, 3.3 mA	
System Off, On	0.3 μ A, 1.2 μ A	
Additional current for RAM retention	30 nA / 4KB block	
Dimensions		
BMD-350	Length	8.7 mm \pm 0.2mm
	Width	6.4 mm \pm 0.2mm
	Height	1.5 mm \pm 0.1mm
Hardware		
Interfaces	SPI Master/Slave x 3 UART Two-Wire Master/Slave (I2C) x 2 GPIO x 32	I2S PWM PDM
Power supply	1.7V to 3.6V	
Temperature Range	-40°C to +85°C	
Certifications		
USA (FCC)	FCC part 15 modular certification FCC ID: 2AA9B05	
Canada (IC)	Industry Canada RSS-210 modular certification IC: 12208A-05	
Europe (CE)	EN 60950-1: A2:2013 3.1 (a): Health and Safety of the User EN 301 489-1 V2.1.1 & 3.1 (b): Electromagnetic Compatibility EN 301 489-17 V3.1.1 EN 300 328 V2.1.1 3.2: Effective use of spectrum allocated	
Japan (MIC)	Ministry of Internal Affairs and Communications (MIC) of Japan pursuant to the Radio Act of Japan MIC: 210-108944	
Australia / New Zealand (RCM)	AS/NZS 4268:2017, Radio equipment and systems – Short range devices	
Brazil (ANATEL)	The BMD-350 is evaluated according to: Resolution 680 of 27/06/2017, Act 14448 of 04/12/2017, Certificate number: 05905-18-11156.	
Eurasia (EAC)	EA3C N RU Д-US.HA27.B.00650/18	
Mexico (IFETEL)	IFT #: RCPRIBM18-1491	
China (SRRC)	CMIIT ID: 2018DJ7255	
Bluetooth	BMD-350 BT5 RF-PHY Component (Tested) – DID: D037298; QDID: 101625	
Export		
BMD-350	ECCN: 5A992.C, Exception 740.17(b)(1) HTS: 8473.30.1180	
Nordic Semiconductor nRF52832		
Additional details	nRF52832 Product Specification Software Development Kit	

Table 2 – Quick Specifications

8 Pin Descriptions – BMD-350

8.1 Pin-out

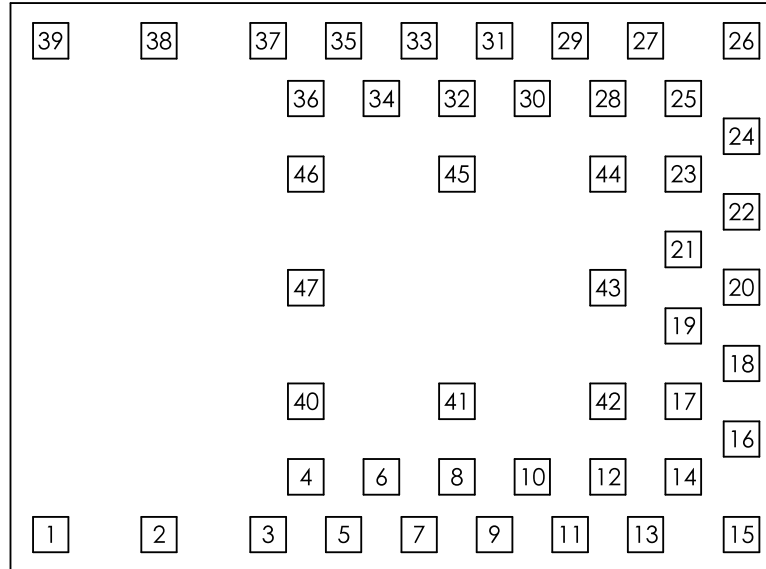

Figure 2 – BMD-350 Pin-out (Top View)

8.2 Pin Descriptions

Pin	Name	Direction	Description
4	SWCLK	In	SWD Clock
5	SWDIO	In/Out	SWD IO
6	P0.20	In/Out	GPIO/TRACECLK
7	P0.21	In/Out	GPIO/RESET
8	P0.18	In/Out	GPIO/TRACEDATA[0]/SWO
9	P0.16	In/Out	GPIO/TRACEDATA[1]
10	P0.17	In/Out	GPIO
11	P0.15	In/Out	GPIO/TRACEDATA[2]
12	P0.13	In/Out	GPIO
13	P0.12	In/Out	GPIO
14	P0.14	In/Out	GPIO/TRACEDATA[3]
16	P0.09	In/Out	GPIO/NFC1
17	P0.10	In/Out	GPIO/NFC2
18	P0.11	In/Out	GPIO
19	P0.06	In/Out	GPIO
20	P0.08	In/Out	GPIO
21	P0.05	In/Out	GPIO/AIN3
22	P0.07	In/Out	GPIO
23	P0.01	In/Out	GPIO/XTAL2 (32.768kHz)
24	P0.00	In/Out	GPIO/XTAL1 (32.768kHz)
27	P0.04	In/Out	GPIO/AIN2
28	P0.02	In/Out	GPIO/AIN0
29	P0.30	In/Out	GPIO/AIN6 ²

Pin	Name	Direction	Description
30	P0.31	In/Out	GPIO/AIN7 ²
31	P0.29	In/Out	GPIO/AIN5 ²
32	P0.27	In/Out	GPIO ²
33	P0.25	In/Out	GPIO ²
34	P0.26	In/Out	GPIO ²
35	P0.23	In/Out	GPIO ²
36	P0.24	In/Out	GPIO ²
41	P0.22	In/Out	GPIO ²
42	P0.19	In/Out	GPIO
44	P0.03	In/Out	GPIO/AIN1
45	P0.28	In/Out	GPIO/AIN4 ²
25	VCC	Power	+1.7V to +3.6V ¹
1, 2, 3, 15, 26, 37, 38, 39, 40, 43, 46, 47	GND	Power	Electrical Ground

Note 1: An internal 4.7 μ F bulk capacitor is included on the module. However, it is good design practice to add additional bulk capacitance as required for your application, i.e. those with heavy GPIO usage and/or current draw.

Note 2: These pins are in close proximity to the nRF52 radio power supply and antenna pins. Radio performance parameters, such as sensitivity, may be affected by high frequency digital I/O (>10kHz) or with large sink/source current on these pins. Nordic recommends using only low frequency, low-drive functions on these pins when possible.

Table 3 – Pin Descriptions

9 Electrical Specifications

9.1 Absolute Maximum Ratings

Symbol	Parameter	Min.	Max.	Unit
V _{CC_MAX}	Voltage on supply pin	-0.3	3.9	V
V _{IO_MAX}	Voltage on GPIO pins (VCC > 3.6V)	-0.3	3.9	V
V _{IO_MAX}	Voltage on GPIO pins (VCC ≤ 3.6V)	-0.3	VCC + 0.3V	V
T _S	Storage Temperature Range	-40	125	°C

Table 4 – Absolute Maximum Ratings

9.2 Operating Conditions

Symbol	Parameter	Min.	Typ.	Max.	Unit
V _{CC}	Operating supply voltage	1.7	3.0	3.6	V
T _{R_VCC}	Supply rise time (0V to 1.7V)	-	-	60	ms
T _A	Operating Ambient Temperature Range	-40	25	85	°C

Table 5 – Operating Conditions

9.3 General Purpose I/O

The general purpose I/O is organized as one port enabling access and control of the 32 available GPIO pins through one port. Each GPIO can be accessed individually with the following user configurable features:

- Input/output direction
- Output drive strength
- Internal pull-up and pull-down resistors
- Wake-up from high- or low-level triggers on all pins
- Trigger interrupt on all pins
- All pins can be used by the PPI task/event system; the maximum number of pins that can be interfaced through the PPI at the same time is limited by the number of GPIOTE channels
- All pins can be individually configured to carry serial interface or quadrature demodulator signals

Symbol	Parameter	Min.	Typ.	Max.	Unit
V _{IH}	Input High Voltage	0.7 x VCC	-	VCC	V
V _{IL}	Input Low Voltage	VSS	-	0.3 x VCC	V
V _{OH}	Output High Voltage	VCC – 0.4	-	VCC	V
V _{OL}	Output Low Voltage	VSS	-	VSS + 0.4	V
R _{PU}	Pull-up Resistance	11	13	16	kΩ
R _{PD}	Pull-down Resistance	11	13	16	kΩ

Table 6 – GPIO

9.4 Peripheral pin assignments

The various peripherals within the BMD-350 may be assigned to nearly any of the GPIO pins through the application. There are some restrictions called out by the nRF52832 product specification. See Note 2 in Table 6 above. Also note that certain peripherals are assigned to particular pins, such the analog inputs and NFC antenna.

9.5 Module RESET

GPIO pin P0.21 may be used for a hardware reset. In order to utilize P0.21 as a hardware reset, the UICR registers PSELRESET[0] and PSELRESET[1] must be set alike, to the value of 0x7FFFFFFF. When P0.21 is programmed as $\overline{\text{RESET}}$, the internal pull-up is automatically enabled. Rigado and Nordic example applications and development kits program P0.21 as $\overline{\text{RESET}}$.

9.6 Debug & Programming

The BMD-350 supports the two pin Serial Wire Debug (SWD) interface and offers flexible and powerful mechanism for non-intrusive debugging of program code. Breakpoints, single stepping, and instruction trace capture of code execution flow are part of this support.

The BMD-350 also supports ETM and ITM trace. Trace data from the ETM and the ITM is sent to an external debugger via a 4-bit wide parallel trace port. In addition to parallel trace, the TPIU supports serial trace via the Serial Wire Output (SWO) trace protocol.

9.7 Clocks

The BMD-350 requires two clocks, a high frequency clock and a low frequency clock.

The high frequency clock is provided on-module by a high-accuracy 32MHz crystal as required by the nRF52832 for radio operation.

The low frequency clock can be provided internally by an RC oscillator or synthesized from the fast clock, or externally by a 32.768kHz crystal. An external crystal provides the lowest power consumption and greatest accuracy. Using the internal RC oscillator with calibration provides acceptable performance for BLE applications at a reduced cost and slight increase in power consumption. Note: the ANT protocol requires the use of an external crystal.

9.7.1 32.768kHz Crystal (LFXO)

Symbol	Parameter	Typ.	Max.	Unit
F _{NOM_LFXO}	Crystal frequency	32.768	-	kHz
F _{TOL_LFXO_BLE}	Frequency tolerance, BLE applications ¹	-	±250	ppm
f _{TOL_LFXO_ANT}	Frequency Tolerance, ANT applications ¹	-	±50	ppm
C _{L_LFXO}	Load Capacitance	-	12.5	pF
C _{O_LFXO}	Shunt Capacitance	-	2	pF
R _{S_LFXO}	Equivalent series resistance	-	100	kΩ
C _{pin}	Input Capacitance on XL1 & XL2 pads	4	-	pF

Note 1: f_{TOL_LFXO_BLE} and f_{TOL_LFXO_ANT} are the maximum allowed for BLE and ANT applications. Actual tolerance depends on the crystal used.

Table 7 – 32.768kHz Crystal (LFXO)

9.7.2 32.768kHz Clock Source Comparison

Symbol	Parameter	Min.	Typ.	Max.	Unit
I _{LFXO}	Current for 32.768kHz Crystal Oscillator	-	0.25	-	μA
I _{LFRC}	Current for 32.768kHz RC Oscillator	-	0.6	1	μA
I _{LFSYNT}	Current for 32.768kHz Synthesized Oscillator	-	100	-	μA
f _{TOL_LFXO_BLE}	Frequency Tolerance, 32.768kHz Crystal Oscillator (BLE Stack) ¹	-	-	±250	ppm
f _{TOL_LFXO_ANT}	Frequency Tolerance, 32.768kHz Crystal Oscillator (ANT Stack) ¹	-	-	±50	ppm
f _{TOL_LFRC}	Frequency Tolerance, 32.768kHz RC Oscillator	-	-	±2	%
f _{TOL_CAL_LFRC}	Frequency tolerance, 32.768kHz RC after calibration	-	-	±250	ppm
f _{TOL_LFSYNT}	Frequency Tolerance, 32.768kHz Synthesized Oscillator	-	-	±48	ppm

Note 1: f_{TOL_LFXO_BLE} and f_{TOL_LFXO_ANT} are the maximum allowed for BLE and ANT applications. Actual tolerance depends on the crystal used.

Table 8 – 32.768kHz Clock Source Comparison

10 Firmware

Rigado recommends that projects for the BMD-350 utilize [Nordic Semiconductor's SDK, DFU, examples](#) and the nRF52832 tools for any new development. This will allow access to the very latest Bluetooth support from Nordic and provide an ongoing path as new features are released.

NOTICE: For legacy applications, Rigado now provides source code through our GitHub repositories for RigDFU, BMDware, Rigablue developer tools and mobile apps for customers to customize and extend on their own. [Please refer to this article at Rigado's Help Center.](#)

10.1 Factory Image

The factory programmed firmware version is indicated on the label. *Programming of the factory image is maintained solely for legacy applications. New development should use the latest [Nordic Semiconductor SDK and examples.](#)*

10.1.1 Firmware Version 'AA'

- Rigado RigDFU v3.2.0 (42)
- Nordic S132 SoftDevice v2.0.0
- BMDware v3.1.0 (50)
- Read-back protection *enabled*.

Modules can be programmed with customer code after a full-chip erase via the SWD interface.

Note: A full-chip erase will clear the Rigado assigned MAC address from memory. With Firmware Version AA and AB, the MAC address must be manually recovered.

10.1.2 Firmware Version 'AB'

- Rigado RigDFU v3.2.1 (43)
- Nordic S132 SoftDevice v2.0.0
- BMDware v3.1.1 (51)
- Read-back protection *enabled*.

Modules can be programmed with customer code after a full-chip erase via the SWD interface.

Note: A full-chip erase will clear the Rigado assigned MAC address from memory. With Firmware Version AA and AB, the MAC address must be manually recovered.

10.1.3 Firmware Version 'AC'

- Rigado RigDFU v3.2.2 (44)
- Nordic S132 SoftDevice v2.0.0
- BMDware v3.1.1 (51)
- Read-back protection *disabled*.

Modules can be programmed with customer code after a full-chip erase via the SWD interface.

Note: A full chip erase will clear the Rigado assigned MAC address from memory; see section 8.3 "MAC Address Info" on how to retain it.

10.1.4 Firmware Version ‘AD’

- Rigado RigDFU v3.3.1 (46)
- Nordic S132 SoftDevice v3.1.0
- BMDware v3.2.1 (60)
- Read-back protection *disabled*.

Modules can be programmed with customer code after a full-chip erase via the SWD interface.

Note: A full chip erase will clear the Rigado assigned MAC address from memory; see section 8.3 “MAC Address Info” on how to retain it.

10.1.5 Firmware Version ‘AE’

- Rigado RigDFU v3.3.1 (46)
- Nordic S132 SoftDevice v3.1.0
- BMDware v3.2.1 (60)
- Read-back protection *disabled*.

Modules can be programmed with customer code after a full-chip erase via the SWD interface.

Note: A full chip erase will clear the Rigado assigned MAC address from memory; see section 8.3 “MAC Address Info” on how to retain it.

Note: ‘AE’ marked modules *may not* be loaded with previous factory firmware due to Nordic nRF52832 Errata #108. ‘AA’ through ‘AD’ marked modules may be loaded with any Factory Firmware version, including ‘AE’.

10.2 Module Programming and Read-Back Protection

For legacy applications, RigDFU allows for UART and OTA updates to RigDFU, the SoftDevice and application firmware.

In order to utilize the SWD port on ‘AA’ and ‘AB’ marked modules, the nRF52832 must be erased and recovered. Without this step, the module will not be recognized by most programmers. This is accomplished through *nrfjprog*, which is provided with the Nordic Semiconductor command line utilities:

```
nrfjprog -f NRF52 --recover
```

A full chip erase is performed, so all components will need to be re-loaded (Bootloader, SoftDevice and application Firmware).

The BMD-300 Series modules may be restored to the factory firmware versions noted above with the utilities available on GitHub at: <https://github.com/rigado/programmers>.

10.3 SoftDevices

Nordic Semiconductor protocol stacks are known as SoftDevices. SoftDevices are pre-compiled, pre-linked binary files. SoftDevices can be programmed in nRF52 series SoCs and are downloadable from the Nordic website. The BMD-350 with the nRF52832 SoC supports the S132 (BLE Central & Peripheral), S212 (ANT) and S312 (ANT and BLE) SoftDevices.

10.3.1 S132

The S132 SoftDevice is a Bluetooth® low energy (BLE) Central and Peripheral protocol stack solution supporting up to twenty connections with an additional Observer and a Broadcaster role all running concurrently. The S132 SoftDevice integrates a BLE Controller and Host and provides a full and flexible API for building Bluetooth Smart nRF52 System on Chip (SoC) solutions.

10.3.2 S212

The S212 SoftDevice is an ANT™ protocol stack solution that provides a full and flexible Application Programming Interface (API) for building ANT System on Chip (SoC) solutions for the nRF52832 chip. The S212 SoftDevice simplifies combining the ANT protocol stack and an application on the same CPU. See the [ANT+ website](#) for membership in the ANT+ Alliance and S212 licensing.

10.3.3 S332

The S332 SoftDevice is a combined ANT and Bluetooth low energy (BLE) protocol stack solution. It supports all four Bluetooth low energy roles (central, peripheral, observer, broadcaster) and ANT. The S332 SoftDevice provides a full and flexible Application Programming Interface (API) for building concurrent ANT and BLE System on Chip (SoC) solutions. It simplifies combining an ANT and BLE protocol stack and an application on the same CPU, therefore eliminating the need for an added device to support concurrent multiprotocol. See the [ANT+ website](#) for membership in the ANT+ Alliance and S332 licensing.

10.4 MAC Address Info

The BMD-350 Series modules comes preprogrammed with a unique MAC address from the factory. The MAC address is also printed on a 2D barcode on the top of the module.

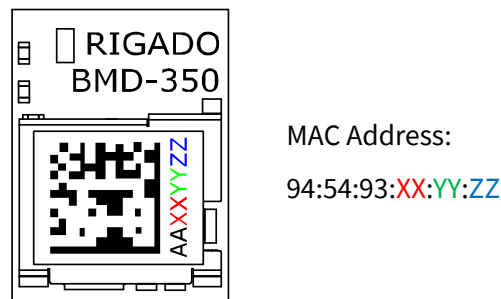

Figure 3 – BMD-350 MAC Address

The 6-byte BLE Radio MAC address is stored in the nRF52832 UICR at NRF_UICR_BASE+0x80 LSB first. Please read the MAC Address Provisioning application note to avoid erasing/overwriting the MAC address during programming. **Important:** Modules with factory firmware ‘AA’ and ‘AB’ are provided with full memory protection enabled, not allowing the UICR to be read via the SWD interface. If performing a full-erase, the MAC can then only be recovered from the 2D barcode and human-readable text. **Note:** Modules with factory firmware code ‘AC’ and later no longer enable read-back protection from the factory, allowing the MAC address to be read with an SWD programmer.

UICR Register:

NRF_UICR + 0x80 (0x10001080): MAC_Addr [0] (0xZZ)
 NRF_UICR + 0x81 (0x10001081): MAC_Addr [1] (0xYY)
 NRF_UICR + 0x82 (0x10001082): MAC_Addr [2] (0xXX)
 NRF_UICR + 0x83 (0x10001083): MAC_Addr [3] (0x93)
 NRF_UICR + 0x84 (0x10001084): MAC_Addr [4] (0x54)
 NRF_UICR + 0x85 (0x10001085): MAC_Addr [5] (0x94)

11 Mechanical Data

11.1 Dimensions

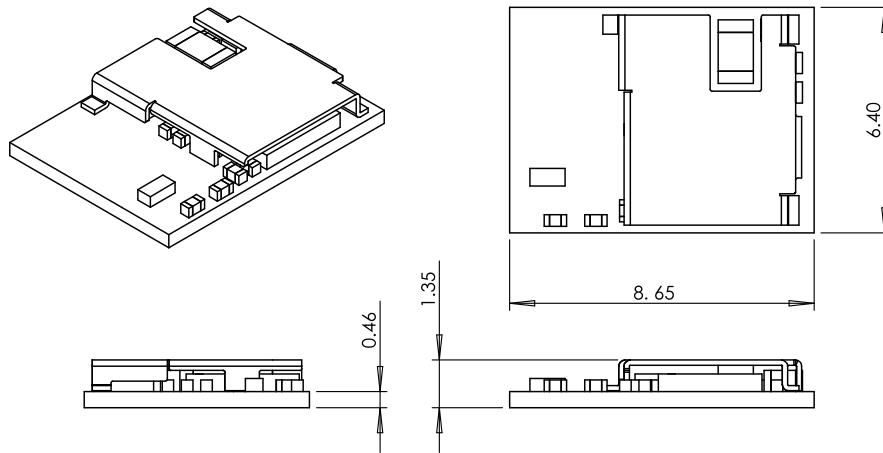

Figure 4 – Mechanical Drawing

11.2 Recommended PCB Land Pads

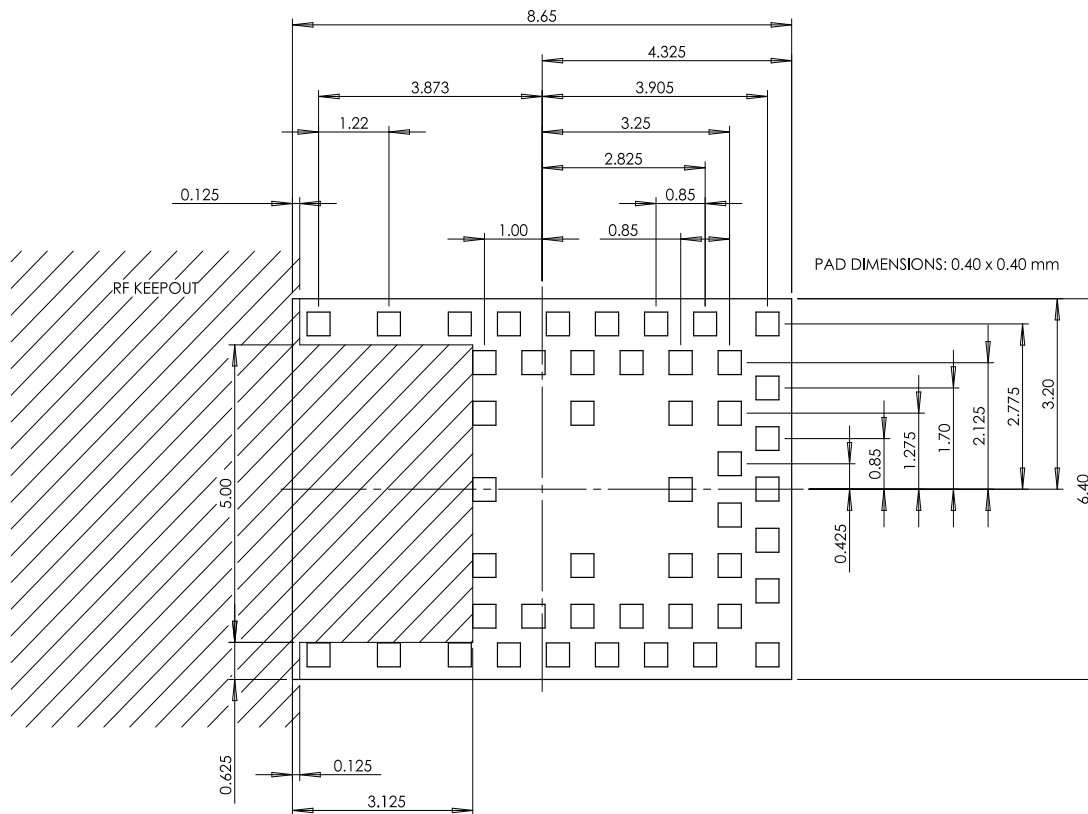

Figure 5 – Recommended PCB Land Pads

11.3 Module Marking

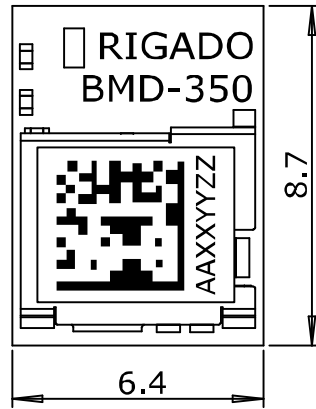

Figure 6 - Module Marking

12 RF Design Notes

12.1 Recommended RF Layout & Ground Plane

For the BMD-350, the integrated antenna requires a suitable ground plane to radiate effectively.

The area under and extending out from the antenna portion of the module should be kept clear of copper and other metal. The module should be placed at the edge of the PCB with the antenna edge facing out. Reducing the ground plane from that shown in Figure 7 will reduce the effective radiated power.

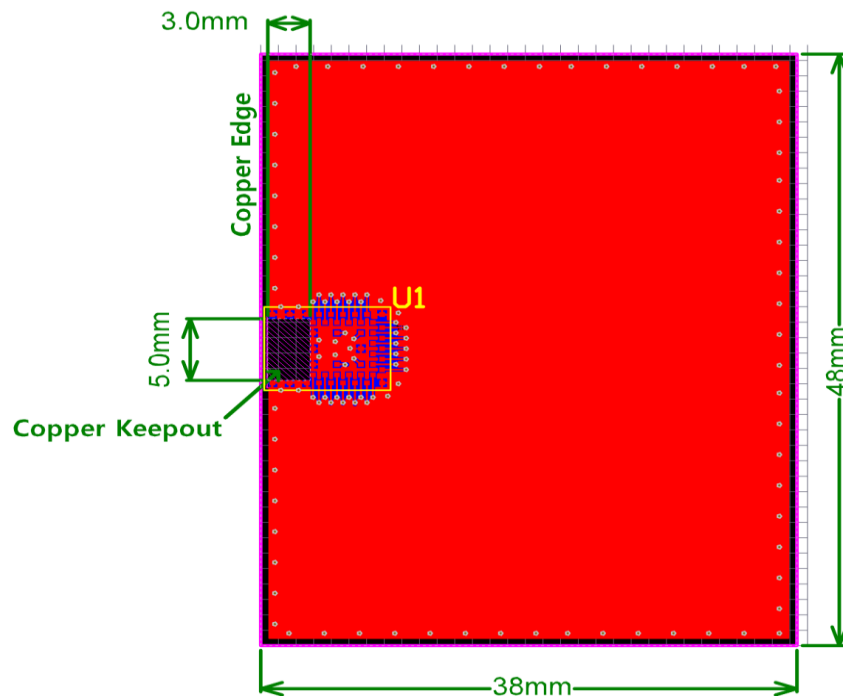

Figure 7 – Recommended RF Layout & Ground Plane

12.2 Mechanical Enclosure

Care should be taken when designing and placing the BMD-350 into an enclosure. Metal should be kept clear from the antenna area, both above and below. Any metal around the module can negatively impact RF performance.

The module is designed and tuned for the antenna and RF components to be in free air. Any potting, epoxy fill, plastic over-molding, or conformal coating can negatively impact RF performance and must be evaluated by the customer.

12.3 Antenna Patterns

Antenna patterns are based on the BMD-350 Evaluation Kit with a ground plane size of 82mm x 56mm. X-Y-Z orientation is shown in Figure 8:

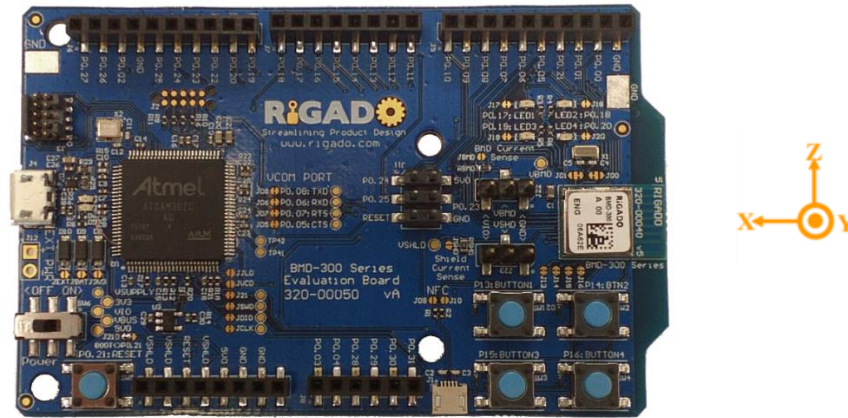

Figure 8 – BMD-350-EVAL X-Y-Z Orientation

12.3.1 X-Y Plane

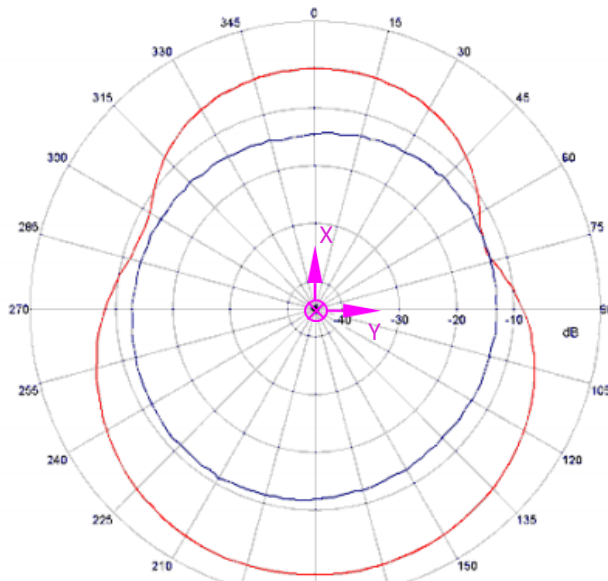

Figure 9 – X-Y Plane Antenna Pattern

12.3.2 Y-Z Plane

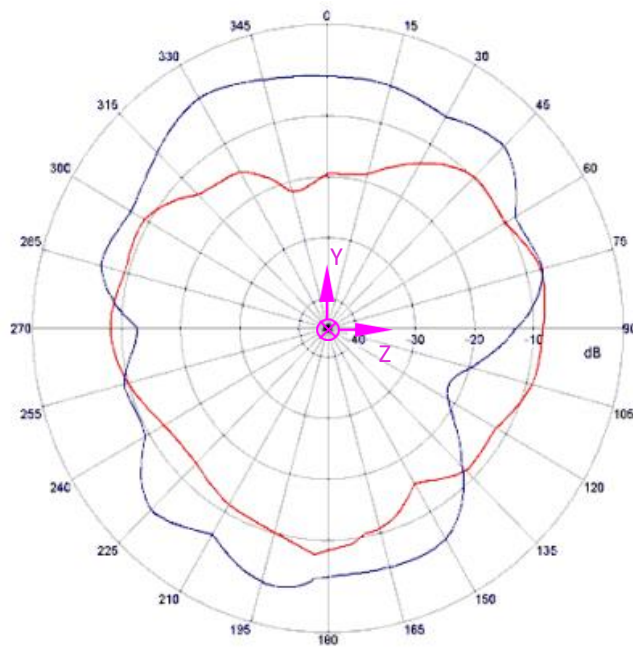

Figure 10 – Y-Z Plane Antenna Pattern

12.3.3 Z-X Plane

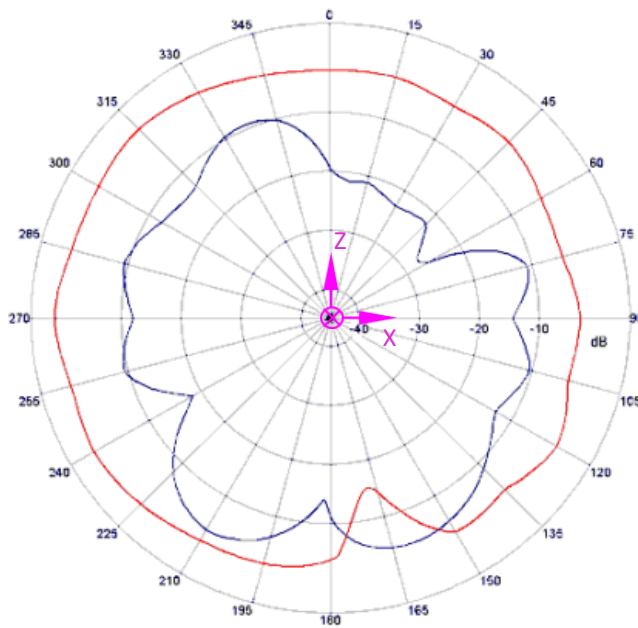

Figure 11 – Z-X Plane Antenna Pattern

13 BMD-350-EVAL Development Kit

The BMD-350-EVAL is a full featured evaluation board that provides a complete I/O pin out to headers, on-board programming and debug, 32.768 kHz crystal, power & virtual COM port over USB, 4 user LEDs, and 4 user buttons. The evaluation boards also provide the option to be powered from a CR2032 coin cell battery and have current sense resistors and headers to allow for convenient current measurements. An Arduino Uno R3 style header is provided for easy prototyping of additional functions. The evaluation boards also support programming off-board BMD-300 Series modules.

14 Bluetooth Qualification

- The Bluetooth SIG maintains the Bluetooth Specification, and ensures that products are properly tested and comply with the Bluetooth license agreements. Companies that list products with the Bluetooth SIG are required to be members of the SIG and submit the listed fees. Refer to this link for details: <https://www.bluetooth.com/develop-with-bluetooth/qualification-listing>
- The Rigado Bluetooth Low Energy modules based on Nordic Semiconductor SoCs are listed as a “Tested Component”. This allows an end-product based on a Rigado module to inherit the component listings without the need to run through all of the tests again. The end-product will often inherit several different listings, known as Qualified Design IDs (QDID), and are identified on a “Declaration of Compliance”. Refer to this Help Center article for creating a Declaration of Compliance: <https://rigado.zendesk.com/hc/en-us/articles/360002645694-Bluetooth-SIG-Launch-Studio-Product-Declaration>
- The list of Qualified Products is found here: <https://launchstudio.bluetooth.com/Listings/Search>
- The BMD-350 primarily utilizes the S132 SoftDevice
- A list of current QDIDs used by Rigado is maintained at the [Rigado Help Center](#)

15 Regulatory Agency Approvals

15.1 United States (FCC):

Rigado's modules have received Federal Communications Commission (FCC) CFR47 Telecommunications, Part 15 Subpart C "Intentional Radiators" modular approval in accordance with Part 15.212 Modular Transmitter approval. Modular approval allows the end user to integrate the module into a finished product without obtaining subsequent and separate FCC approvals for intentional radiation, provided no changes or modifications are made to the module circuitry. Changes or modifications could void the user's authority to operate the equipment. The end user must comply with all of the instructions provided by the Grantee, which indicate installation and/or operating conditions necessary for compliance.

The finished product is required to comply with all applicable FCC equipment authorizations regulations, requirements and equipment functions not associated with the transmitter module portion. For example, compliance must be demonstrated to regulations for other transmitter components within the host product; to requirements for unintentional radiators (Part 15 Subpart B "Unintentional Radiators"), such as digital devices, computer peripherals, radio receivers, etc.; and to additional authorization requirements for the non-transmitter functions on the transmitter module (i.e., Verification, or Declaration of Conformity) (e.g., transmitter modules may also contain digital logic functions) as appropriate.

Caution! The OEM is still responsible for verifying end-product compliance with FCC Part 15, subpart B limits for unintentional radiators through an accredited test facility.

15.1.1 Labeling & User Information Requirements

The BMD-350 is assigned the FCC ID number: 2AA9B05

If the FCC ID is not visible when the module is installed inside another device, then the outside of the finished product into which the module is installed must also display a label referring to the enclosed module. This exterior label can use the following or similar wording:

Contains FCC ID: 2AA9B05

In addition to marking the product with the appropriate FCC ID, the end-product user manual may also require specific information based on the digital device classification. Refer to the [FCC Rules, Title 47, Subchapter A, Part 15, Subpart B, Chapter §15.105](#) for specific wording of the notices.

15.1.2 RF Exposure

All transmitters regulated by FCC must comply with RF exposure requirements. [KDB 447498 General RF Exposure Guidance](#) provides guidance in determining whether proposed or existing transmitting facilities, operations or devices comply with limits for human exposure to Radio Frequency (RF) fields adopted by the Federal Communications Commission (FCC).

This module is approved for installation into mobile and/or portable host platforms and must not be co-located or operating in conjunction with any other antenna or transmitter except in accordance with FCC multi-transmitter guidelines. End users must be provided with transmitter operating conditions for satisfying RF Exposure compliance.

15.2 Canada (IC)

Rigado's modules have been certified for use in Canada under Industry Canada (IC) Radio Standards Specification (RSS) RSS-210 and RSSGen. Modular approval permits the installation of a module in a host device without the need to recertify the device.

15.2.1 Labeling & User Information Requirements

The BMD-350 is assigned the IC ID number: 12208A-05

Labeling Requirements for the Host Device (from Section 3.2.1, RSS-Gen, Issue 3, December 2010): The host device shall be properly labeled to identify the module within the host device. The Industry Canada certification label of a module shall be clearly visible at all times when installed in the host device, otherwise the host device must be labeled to display the Industry Canada certification number of the module, preceded by the words "Contains transmitter module", or the word "Contains", or similar wording expressing the same meaning, as follows:

Contains transmitter module IC: 12208A-05

User Manual Notice for License-Exempt Radio Apparatus (from Section 7.1.3 RSS-Gen, Issue 3, December 2010): User manuals for license-exempt radio apparatus shall contain the following or equivalent notice in a conspicuous location in the user manual or alternatively on the device or both:

This device complies with Industry Canada license exempt RSS standard(s). Operation is subject to the following two conditions: (1) this device may not cause interference, and (2) this device must accept any interference, including interference that may cause undesired operation of the device.

Le présent appareil est conforme aux CNR d'Industrie Canada applicables aux appareils radio exempts de licence. L'exploitation est autorisée aux deux conditions suivantes: (1) l'appareil ne doit pas produire de brouillage, et (2) l'utilisateur de l'appareil doit accepter tout brouillage radioélectrique subi, même si le brouillage est susceptible d'en compromettre le fonctionnement.

Transmitter Antenna (from Section 7.1.2 RSS-Gen, Issue 3, December 2010): User manuals for transmitters shall display the following notice in a conspicuous location:

Under Industry Canada regulations, this radio transmitter may only operate using an antenna of a type and maximum (or lesser) gain approved for the transmitter by Industry Canada. To reduce potential radio interference to other users, the antenna type and its gain should be so chosen that the equivalent isotropically radiated power (e.i.r.p.) is not more than that necessary for successful communication.

Conformément à la réglementation d'Industrie Canada, le présent émetteur radio peut fonctionner avec une antenne d'un type et d'un gain maximal (ou inférieur) approuvé pour l'émetteur par Industrie Canada. Dans le but de réduire les risques de brouillage radioélectrique à l'intention des autres utilisateurs, il faut choisir le type d'antenne et son gain de sorte que la puissance isotrope rayonnée équivalente (p.i.r.e.) ne dépasse pas l'intensité nécessaire à l'établissement d'une communication satisfaisante.

15.2.2 RF Exposure

All transmitters regulated by IC must comply with RF exposure requirements listed in RSS-102 - Radio Frequency (RF) Exposure Compliance of Radiocommunication Apparatus (All Frequency Bands). This module is approved for installation into mobile and/or portable host platforms and must not be co-located or operating in conjunction with any other antenna or transmitter except in accordance with Industry Canada's multi-transmitter guidelines. End users must be provided with transmitter operating conditions for satisfying RF Exposure compliance.

15.3 Europe (CE)

The BMD-350 is a Radio Equipment Directive assessed radio module that is CE compliant and have been manufactured and tested with the intention of being integrated into a final product.

The BME-300 has been tested to current Radio Equipment Directives

- EN 60950-1: 2006 + A11: 2009 + A1: 2010 + A12: 2011 + A2: 2013
- ETSI EN 300 328 V 2.1.1
- ETSI EN 301 489-1 V2.1.1
- ETSI EN 301 489-17 V3.1.1

The Radio Equipment Directive – Compliance Association (RED-CA) provides guidance on modular devices at the RED-CA website: <http://www.redca.eu/Pages/Documents%201.htm>.

15.3.1 Labeling & User Information Requirements

The label on the final products which contain a Rigado module must follow CE marking requirements. The “R&TTE Compliance Association Technical Guidance Note 01” provides guidance on final product CE marking.

15.4 Japan (MIC)

The BMD-350 module has received type certification and is labeled with its own technical conformity mark and certification number as required to conform to the technical standards regulated by the Ministry of Internal Affairs and Communications (MIC) of Japan pursuant to the Radio Act of Japan. Integration of this module into a final end-product does not require additional radio certification provided installation instructions are followed and no modifications of the module are allowed. Additional testing may be required:

- If the host product is subject to electrical appliance safety (for example, powered from an AC mains), the host product may require Product Safety Electrical Appliance and Material (PSE) testing. The integrator should contact their conformance laboratory to determine if this testing is required.
- There is a voluntary Electromagnetic Compatibility (EMC) test for the host product administered by VCCI: http://www.vcci.jp/vcci_e/index.html

The label on the end-product which contains a BMD-350 Series module must follow the MIC marking requirements. Labeling requirements for Japan available at the Ministry of Internal Affairs and Communications (MIC) website: <http://www.tele.soumu.go.jp/e/index.htm>.

The BMD-350 module is labeled with its assigned technical conformity mark and certification number. The end-product in which this module is being used must have an external label referring to the type certified module inside:

Contains transmitter module with certificate number:

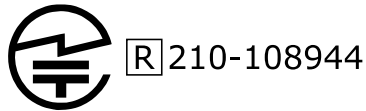

Figure 12 – Japan MIC Mark

15.5 Australia / New Zealand (RCM)

The BMD-350 has been tested to comply with the AS/NZS 4268:2017, Radio equipment and systems – Short range devices – Limits and methods of measurement. The report may be downloaded from www.rigado.com, and may be used as evidence in obtaining permission to use the Regulatory Compliance Mark (RCM).

Information on registration as a Responsible Party, license and labeling requirements may be found at the following websites:

Australia: <http://www.acma.gov.au/theACMA/radiocommunications-short-range-devices-standard-2004>

New Zealand: <http://www.rsm.govt.nz/compliance>

Only Australian-based and New Zealand-based companies who are registered may be granted permission to use the RCM. An Australian-based or New Zealand-based agent or importer may also register as a Responsible Party to use the RCM on behalf of a company not in Australia or New Zealand.

15.6. Brazil (ANATEL)

The BMD-350 is evaluated according to: Resolution 680 of 27/06/2017, Act 14448 of 04/12/2017, Certificate number: 05905-18-11156.

The end-products that contain these modules must list the ANATEL number from the modular approval. The number can go on the end-product label, manual, box or software, with the following phrase:

Contains ANATEL approved module # 05905-18-11156

15.7. Eurasia (EAC)

The BMD-350 is certified in Eurasia (EAC) with the following number:

EAЭC N RU Д-US.HA27.B.00650/18

The image of the unified product turnover sign EAC is a combination of three stylized letters E, A, and C graphically shown using straight angles and having the same length and width as well as precise square proportion against the light of contrasting background. Two versions are shown here:



Marking Application Procedure and Rules:

- The dimensions of the EAC marks are determined by the manufacturer (supplier) authorized to use it.
- The basic size is at least 5 mm.
- Dimensions of the unified turnover sign must guarantee that its elements are accurate and visible with unaided eye against the common color background of the object.
- If unable to indicate on product, must be added to accompanying document.

15.8. Mexico (IFETEL)

The end-products that contain these modules must list the IFETEL number from the modular approval. The number can go on the end-product label, manual, box or software, with the following phrase:

Este equipo contiene el módulo BMD-350 con Número IFETEL: RCPRIBM18-1491

- or -

Este equipo contiene el módulo con IFT #: RCPRIBM18-1491

15.9. China (SRRC)

The BMD-350 module has received certification of conformity in accordance with the China MIIT Notice 2014-01 of State Radio Regulation Committee (SRRC) certification scheme. Integration of this module into a final product does not require additional radio certification, provided installation instructions are followed and no modifications of the module are allowed. The BMD-350 is marked with the following ID:

CMIIT ID: 2018DJ7255

15.10 Environmental

15.10.1 RoHS

Rigado's modules are in compliance with Directive 2011/65/EU, 2015/863/EU of the European Parliament and the Council on the restriction of the use of certain hazardous substances in electrical and electronic equipment. The declaration may be found here: <https://go.rigado.com/RoHS-Modules>

15.10.2 REACH

Rigado's modules listed below do not contain the [191 SVHC \(Substance of Very High Concern\)](#), as defined by Directive EC/1907/2006 Article according to REACH Annex XVII. The compliance statement may be found here: <https://go.rigado.com/REACH-Modules>

15.10.3 California Proposition 65 (P65)

This product can expose you to Nickel (metallic), which is known to the State of California to cause cancer. For more information go to www.P65Warnings.ca.gov. Warnings are not required where the listed chemical is inaccessible to the average user of the end-product.

16 Solder Reflow Temperature-Time Profile

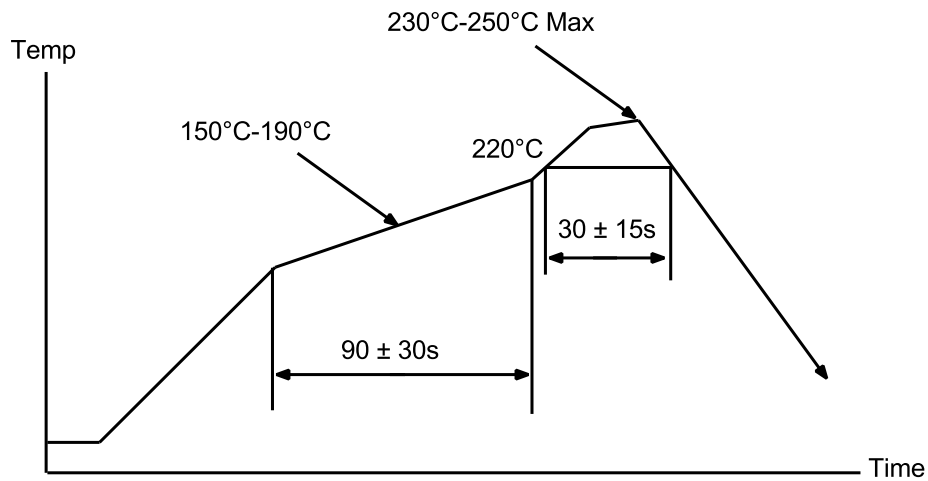

Figure 13 – Reflow Profile for Lead Free Solder

16.1 Moisture Sensitivity Level

The BMD-350 is rated for MSL 3, 168-hour floor life after opening.

17 Packaging and Labeling

17.1 Carrier Tape Dimensions

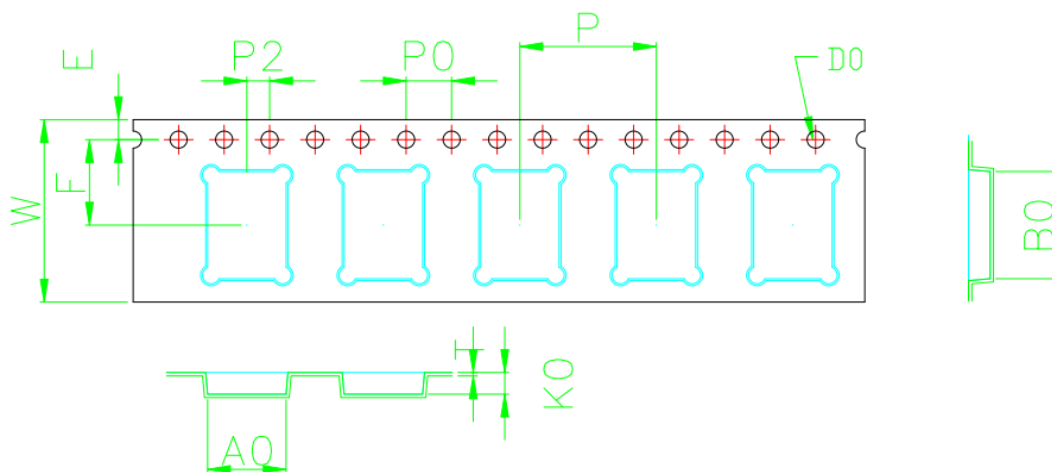

W	16.00±0.30	P	12.00±0.10	A0	6.90±0.10	B0	9.40±0.10
S	0.00±0.10	P0	4.00±0.10	A1		B1	
E	1.75±0.10	P2	2.00±0.10			B2	
F	7.50±0.10	D0	∅1.50 ± ₀ ^{0.10}	K0	1.90±0.10	K1	
T	0.30±0.05	D1					

Figure 14 – Carrier Tape Dimensions

17.2 Reel Packaging

Modules are packaged on 330mm reels loaded with 1000 modules. Each reel is placed in an antistatic bag with a desiccant pack and humidity card and placed in a 340x350x65mm box. An antistatic warning and reel label are adhered to the outside of the bag.

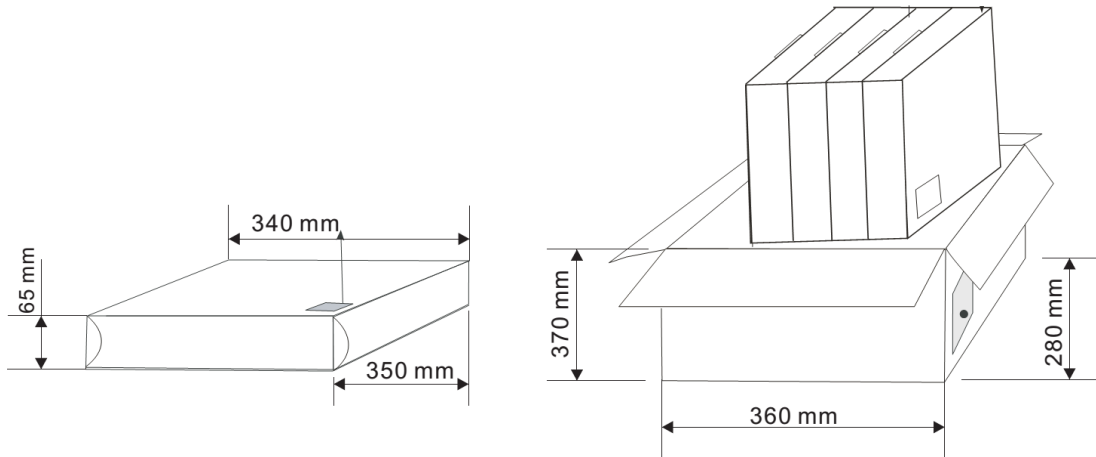

Figure 15 – Reel Cartons

17.3 Packaging Label

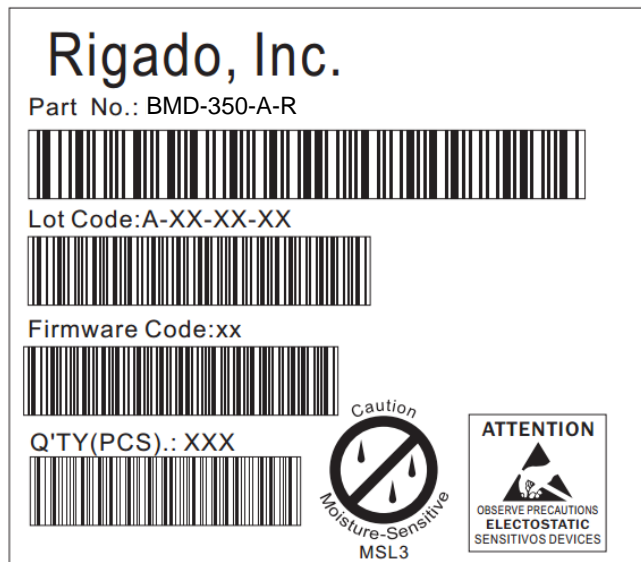

Figure 16 – Packaging Label

18 Cautions

- 1) The guidelines of this document should be followed in order to assure proper performance of the module.
- 2) This product is intended for use in office, business, and residential applications and not designed for medical applications. See the life support policy below for use in medical applications.
- 3) This module may short-circuit. If a short circuit can result in serious damage or injury, then failsafe precautions should be used. This could be accomplished by redundant systems and protection circuits.
- 4) Supply voltage to the module should not be higher than the specified inputs or reversed. Additionally, it should not contain noise, spikes, or AC ripple voltage.
- 5) Avoid use with other high frequency circuits.
- 6) Use methods to eliminate static electricity when working with the module as it can damage the components.
- 7) Contact with wires, the enclosure, or any other objects should be avoided.
- 8) Refer to the recommended land pattern when designing for this module.
- 9) If hand soldering is used, be sure to use the precautions outlined in this document.
- 10) This module should be kept away from heat, both during storage and after installation.
- 11) Do not drop or physically shock the module.
- 12) Do not damage the interface surfaces of the module.
- 13) The module should not be mechanically stressed at any time (storage, handling, installation).
- 14) Do not store or expose this module to:
 - Humid or salty air conditions
 - High concentrations of corrosive gasses.
 - Long durations of direct sunlight.
 - Temperatures lower than -40°C or higher than 125°C.

19 Life Support and other High-Risk Use Warning

This product is not designed nor intended for use in a life support device or system, nor for use in other fault-intolerant, hazardous or other environments requiring fail-safe performance, such as any application in which the failure or malfunction of the product could lead directly or indirectly to death, bodily injury, or physical or property damage (collectively, “High-Risk Environments”). RIGADO EXPRESSLY DISCLAIMS ANY EXPRESS OR IMPLIED WARRANTY OF FITNESS FOR USE IN HIGH-RISK ENVIRONMENTS. The customer using this product in a High-Risk Environment agrees to indemnify and defend Rigado from and against any claims and damages arising out of such use.

20 Related Documents

Rigado Documents:

Visit the [Rigado File Downloads](#) page for BMD-350 documentation.

- BMD-3xx-EVAL User Guide
- BMD-300 Series Range Test
- BMD-3xx-EVAL Reference Design

Nordic Documents:

Visit the [Nordic Document Library](#) for a comprehensive library of Nordic technical documentation.

- nRF52832 Product Specification
- nRF52832 S132 Soft Device Specification
- nRF52832 S212 Soft Device Specification
- nRF52832 S332 Soft Device Specification

21 Contact Information

Headquarters

Rigado Inc.
3950 Fairview Industrial Drive SE, Suite 100
Salem, Oregon 97302

Portland

Rigado Inc.
101 SW Main Street, Suite 2000
Portland, Oregon 97204

Tel: +1 971 208 9870

Fax: +1 971 208 9869

Sales: <https://www.rigado.com/contact/>

Support: <https://rigado.zendesk.com/hc>

22 List of Tables

Table 1 – Ordering Information	2
Table 2 – Quick Specifications	3
Table 3 – Pin Descriptions.....	5
Table 4 – Absolute Maximum Ratings.....	6
Table 5 – Operating Conditions	6
Table 6 – GPIO	6
Table 7 – 32.768kHz Crystal (LFXO)	7
Table 8 – 32.768kHz Clock Source Comparison	8
Table 9 – Document History.....	30

23 List of Figures

Figure 1 – Block Diagram	2
Figure 2 – BMD-350 Pin-out (Top View)	4
Figure 3 – BMD-350 MAC Address.....	12
Figure 4 – Mechanical Drawing.....	13
Figure 5 – Recommended PCB Land Pads.....	13
Figure 6 – Module Marking.....	14
Figure 7 – Recommended RF Layout & Ground Plane	15
Figure 8 – BMD-350-EVAL X-Y-Z Orientation.....	16
Figure 9 – X-Y Plane Antenna Pattern	16
Figure 10 – Y-Z Plane Antenna Pattern	17
Figure 11 – Z-X Plane Antenna Pattern.....	17
Figure 12 – Japan MIC Mark	22
Figure 13 – Reflow Profile for Lead Free Solder	25
Figure 14 – Carrier Tape Dimensions.....	25
Figure 15 – Reel Cartons.....	26
Figure 16 – Packaging Label	26

Document History

Revision	Date	Changes / Notes
0.8	2015-11-06	Initial preliminary release
0.8.1	2015-11-10	Updated Table 5, Figure 5, Section 7.5. Corrected antenna references
0.8.2	2015-11-11	Updated Figure 1
0.8.3	2015-11-20	Updated current ratings from nRF52832 OPC v0.6.3. Corrected Table 3
0.9	2016-03-17	Added BMD-301, GPIO notes, MSL, updated certifications, updated electrical specifications
0.9.4	2016-03-23	Added BMD-301 antennas
1.0	2016-05-04	Production Release; removed pending for FCC, Japan (MIC), & Bluetooth
1.1	2016-05-20	Removed pending for IC, MIC (BMD-301)
1.2	2016-06-03	Added Factory Firmware Version AB information
1.3	2016-06-06	Updated Module Programming and Read-Back Protection section
1.4	2016-07-07	Added preliminary information for the BMD-350
1.5	2016-07-28	Added RigDFU and BMDware pin numbers, corrected nRF52832 PS link
1.6	2016-08-10	Corrected RESET pin number on BMD-350
1.7	2016-11-10	Updated layout drawings, added more BMD-350 data + certs
1.8	2016-12-02	Added BMD-350 Japan certificate number
1.9	2017-08-10	Add RED for BMD-300, BMD-301, BMD-350; BT DID for BMD-350, Factory Firmware AD
1.10	2017-09-29	Added Bluetooth 5 QDIDs, Factory Firmware AE
1.11	2018-04-17	Added antenna gain in section 5
1.2	2018-10-08	Added BMDware, RigDFU, Rigablue notice in Section 8. Removed BMDware and RigDFU pin-out sections 6.3 and 6.4 Called out BMD-300/301/350 in title rather than "Series"
2.0	2019-01-22	Updated to new format BMD-300, BMD-301, and BMD-350 are now in separate datasheets Updated Life Support and other High-Risk Use Warning

Table 9 – Document History