

PIN Silicon Photodiode

OP905, OP906

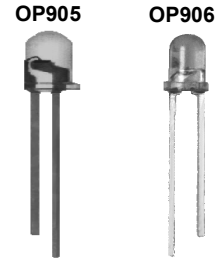

Features:

- Clear epoxy package
- Linear response vs. irradiance
- Fast switching time
- Narrow receiving angle
- T-1 package style
- Small package style ideal for space-limited applications

Description:

Each **OP905** and **OP906** device consists of a PIN silicon photodiode molded in a clear epoxy package that allows spectral response from visible to infrared light wavelengths. The T-1 package style is ideal for space-limited applications. Both devices have a narrow receiving angle, which provides excellent on-axis coupling. Both are also 100% production tested using infrared light for close correlation with OPTEK's GaAs and GaAlAs emitters.

Please refer to Application Bulletins 208 and 210 for additional design information and reliability (degradation) data.

Applications:

- Non-contact reflective object sensor
- Assembly line automation
- Machine automation
- Machine safety
- End of travel sensor
- Door sensor

Ordering Information			
Part Number	Sensor	Viewing Angle	Lead Length
OP905	Photodiode	±17°	0.50"
OP906		±20°	

OP905 - OP906



Pin #	Diode
1	Anode
2	Cathode

OP905

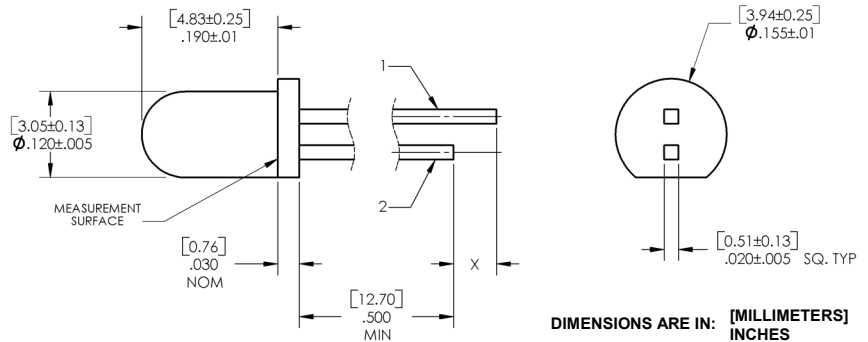

OP906

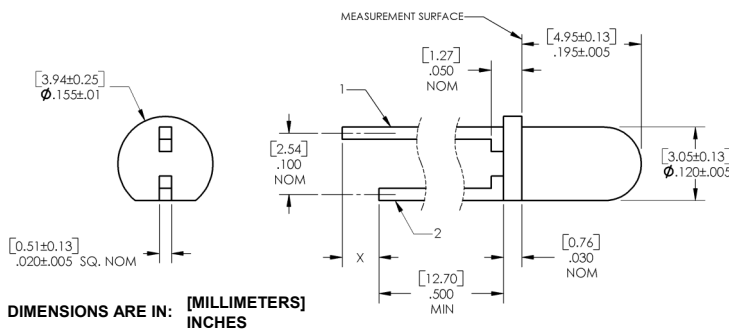

CONTAINS POLYSULFONE
To avoid stress cracking, we suggest using ND Industries' **Vibra-Tite** for thread-locking. **Vibra-Tite** evaporates fast without causing structural failure in OPTEK'S molded plastics.



RoHS

General Note

TT Electronics reserves the right to make changes in product specification without notice or liability. All information is subject to TT Electronics' own data and is considered accurate at time of going to print.

OPTEK Technology, Inc.
1645 Wallace Drive, Carrollton, TX 75006 | Ph: +1 972 323 2200
www.optekinc.com | www.ttelectronics.com

Electrical Specifications

Absolute Maximum Ratings ($T_A = 25^\circ\text{C}$ unless otherwise noted)	
Reverse Breakdown Voltage	60 V
Storage & Operating Temperature Range	-40°C to $+100^\circ\text{C}$
Lead Soldering Temperature [1/16 inch (1.6mm) from the case for 5 sec. with soldering iron]	$260^\circ\text{C}^{(1)}$
Reverse Breakdown Voltage	60 V
Power Dissipation	100 mW ⁽²⁾

Electrical Characteristics ($T_A = 25^\circ\text{C}$ unless otherwise noted)						
SYMBOL	PARAMETER	MIN	TYP	MAX	UNITS	TEST CONDITIONS
I_L	Reverse Light Current					$V_R = 5\text{ V}, E_E = 0.50\text{ mW/cm}^2^{(3)}$
	OP905	14	-	32	μA	
	OP906	16	-	35		
I_D	Reverse Dark Current	-	1	60	nA	$V_R = 30\text{ V}, E_E = 0^{(4)}$
$V_{(BR)}$	Reverse Breakdown Voltage	60	-	-	V	$I_R = 100\ \mu\text{A}$
V_F	Forward Voltage	-	-	1.2	V	$I_F = 1\text{ mA}$
C_T	Total Capacitance	-	4	-	pF	$V_R = 20\text{ V}, E_E = 0, f = 1.0\text{ MHz}$
t_r	Rise Time	-	5	-	ns	$V_R = 20\text{ V}, \lambda = 850\text{ nm}, R_L = 50\ \Omega$
t_f	Fall Time	-	5	-		

Notes:

- (1) RMA flux is recommended. Duration can be extended to 10 seconds maximum when flow soldering. A maximum of 20 grams force may be applied to leads when soldering.
- (2) Derate linearly 1.67 mW/ $^\circ\text{C}$ above 25°C .
- (3) Light source is an unfiltered GaAs LED with a peak emission wavelength of 935 nm and a radiometric intensity level which varies less than 10% over the entire lens surface of the photodiode being tested.
- (4) Calculate the typical dark current in nA using the formula $I_D = 10^{(0.042T_A - 1.5)}$ where T_A is ambient temperature in $^\circ\text{C}$.

General Note

TT Electronics reserves the right to make changes in product specification without notice or liability. All information is subject to TT Electronics' own data and is considered accurate at time of going to print.

OPTEK Technology, Inc.
1645 Wallace Drive, Carrollton, TX 75006 | Ph: +1 972 323 2200
www.optekinc.com | www.ttelectronics.com

Performance OP905

Relative Response vs. Wavelength

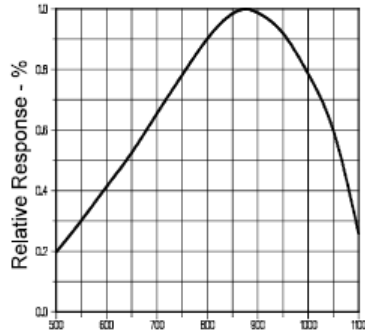

λ - Wavelength - nm

Coupling Characteristics
OP905 and OP265

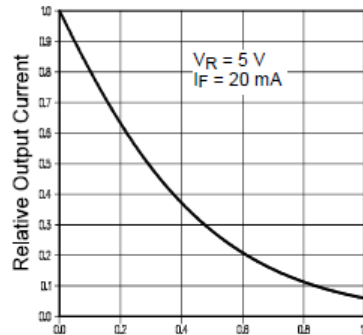

Distance Between Lens Tips - inches

Normalized Light Current vs Reverse Voltage

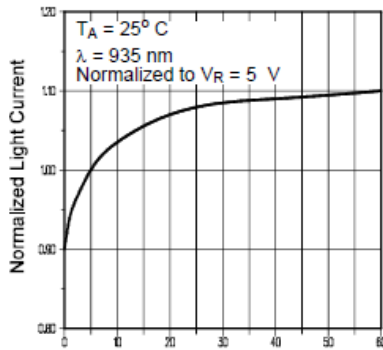

V_R - Reverse Voltage - V

Total Capacitance vs Reverse Voltage

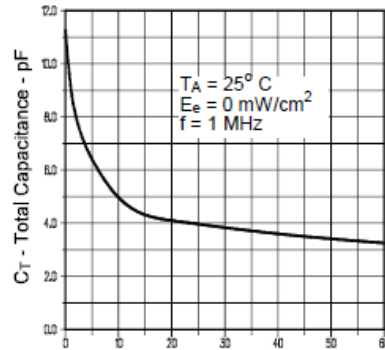

V_R - Reverse Voltage - V

Normalized Light and Dark Current vs Ambient Temperature

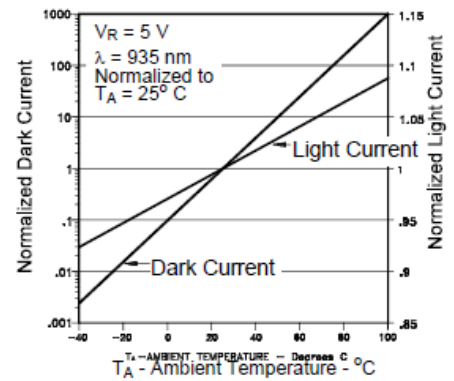

Light Current vs. Irradiance

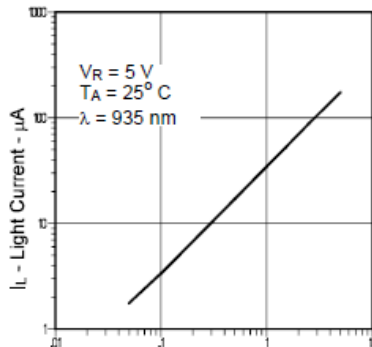

E_e - Irradiance - mW/cm^2

Switching Time Test Circuit

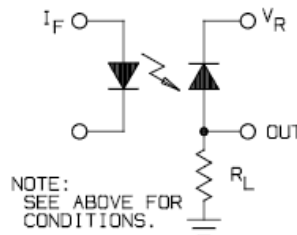

Light Current vs. Angular Displacement

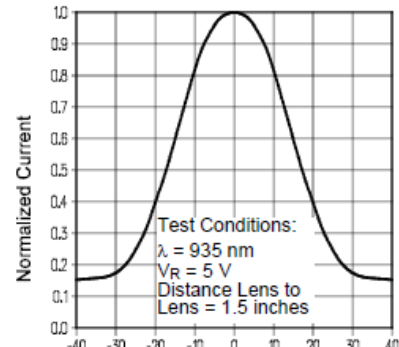

θ - Angular Displacement - Deg.

General Note

TT Electronics reserves the right to make changes in product specification without notice or liability. All information is subject to TT Electronics' own data and is considered accurate at time of going to print.

OPTEK Technology, Inc.
1645 Wallace Drive, Carrollton, TX 75006 | Ph: +1 972 323 2200
www.optekinc.com | www.ttelectronics.com

PIN Silicon Photodiode

OP905, OP906



Performance OP906

Relative Response vs. Wavelength

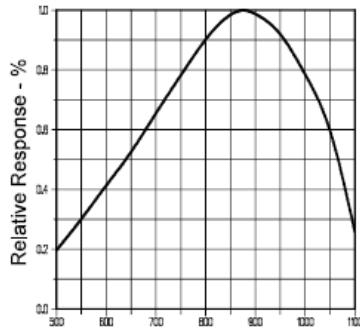

λ - Wavelength - nm

Coupling Characteristics
OP906 and OP266

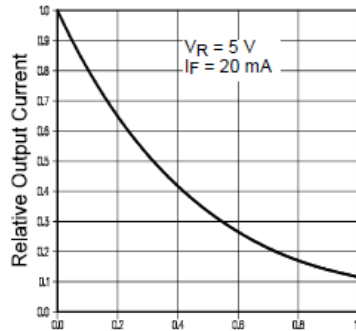

Distance Between Lens Tips - inches

Normalized Light Current vs Reverse Voltage

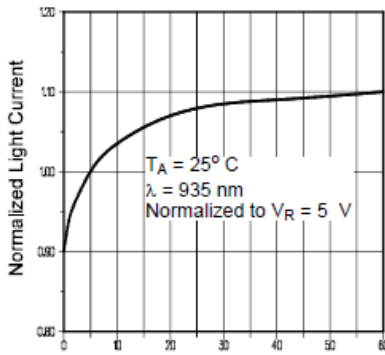

V_R - Reverse Voltage - V

Total Capacitance vs Reverse Voltage

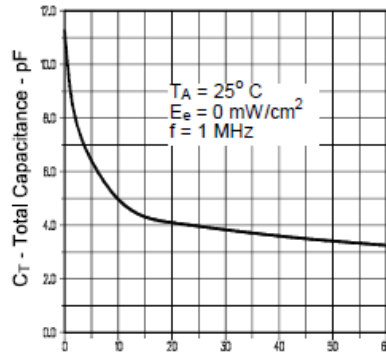

V_R - Reverse Voltage - V

Normalized Light and Dark Current vs Ambient Temperature

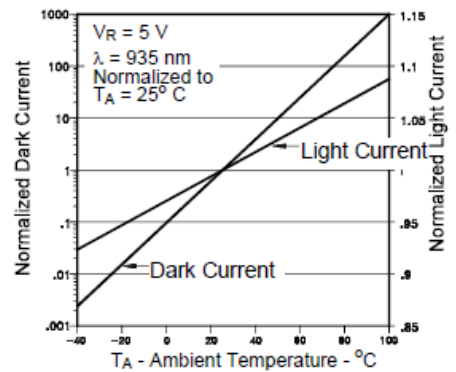

Light Current vs. Irradiance

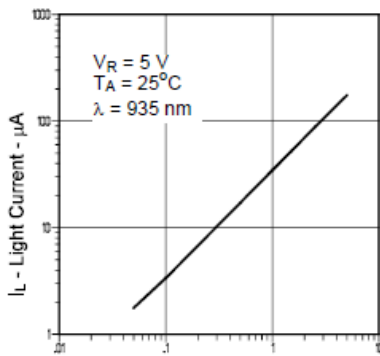

E_e - Irradiance - mW/cm^2

Switching Time Test Circuit

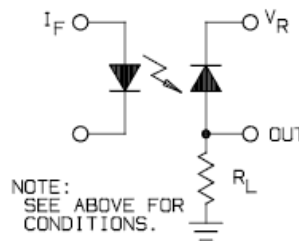

Light Current vs. Angular Displacement

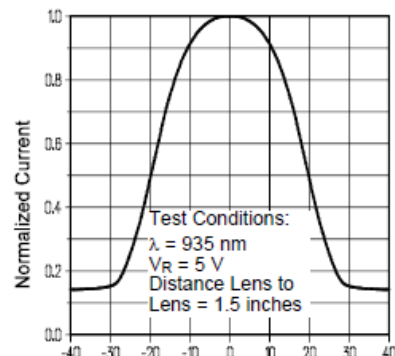

θ - Angular Displacement - Deg.

General Note

TT Electronics reserves the right to make changes in product specification without notice or liability. All information is subject to TT Electronics' own data and is considered accurate at time of going to print.