

TOSHIBA CDMOS Integrated Circuit Silicon Monolithic

TC62D748AFG, TC62D748AFNAG, TC62D748BFNAG

16-Output Constant Current LED Driver

TC62D748 series are an LED driver with a sink type constant current output.

It is the best for lighting the LED module and the LED display.

This IC consists of a constant current output circuit of 16 outputs, a shift register of 16 bits, a latch of 16 bits, and 16 AND gates.

The output current of 16 outputs can be set by one external resistance.

Moreover, high-speed data transfer is possible by adoption of a CMOS process.

This IC can operate with the power supply voltage of a 3.3 V system and a 5 V system.

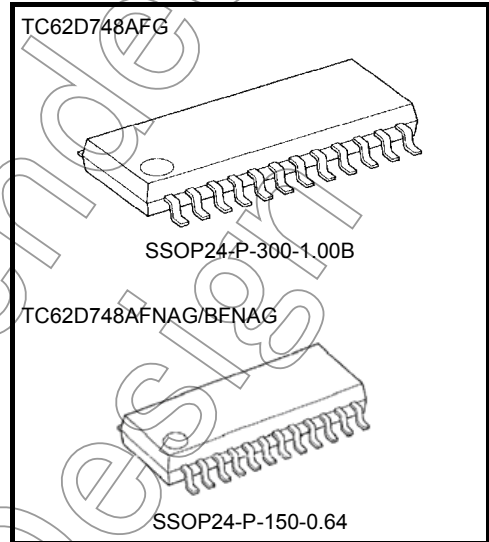

Weight
 SSOP24-P-300-1.00B : 0.29 g (typ.)
 SSOP24-P-150-0.64 : 0.14 g (typ.)

Features

- Power supply voltages : VDD = 3.3 V to 5.0 V
- 16-output built-in
- Output current setting range : IOUT = 1.5 to 90 mA
- Current accuracy (@ REXT = 1.2 kΩ, VOUT = 1.0 V, VDD = 3.3 V, 5.0 V)
 - : S rank ; Between outputs ± 1.5 % (max)
 - : S rank ; Between devices: ± 1.5 % (max)
 - : N rank ; Between outputs ± 2.5 % (max)
 - : N rank ; Between devices: ± 2.5 % (max)
- Output voltage : VOUT = 17 V (max)
- High-speed output switching : twOE(L) = 25 ns (min), tor = 30ns (typ.), tof = 10ns (typ.)
 There is TC62D749 as an output switching high-speed version of this product.
- Input signal voltage level : 3.3 V and 5.0 V CMOS interfaces
 (Schmitt trigger input)
- Serial data transfer rate : 25 MHz (max) @cascade connection
- Operation temperature range : Topr = -40 to 85 °C
- Power-on-reset function built-in : When the power supply is turned on, internal data is reset.
- Package : AFG type SSOP24-P-300-1.00B
 : AFNAG type SSOP24-P-150-0.64
 : BFNAG type SSOP24-P-150-0.64

(Please ask Toshiba sales dept or agent for details for products' name.)

Block Diagram

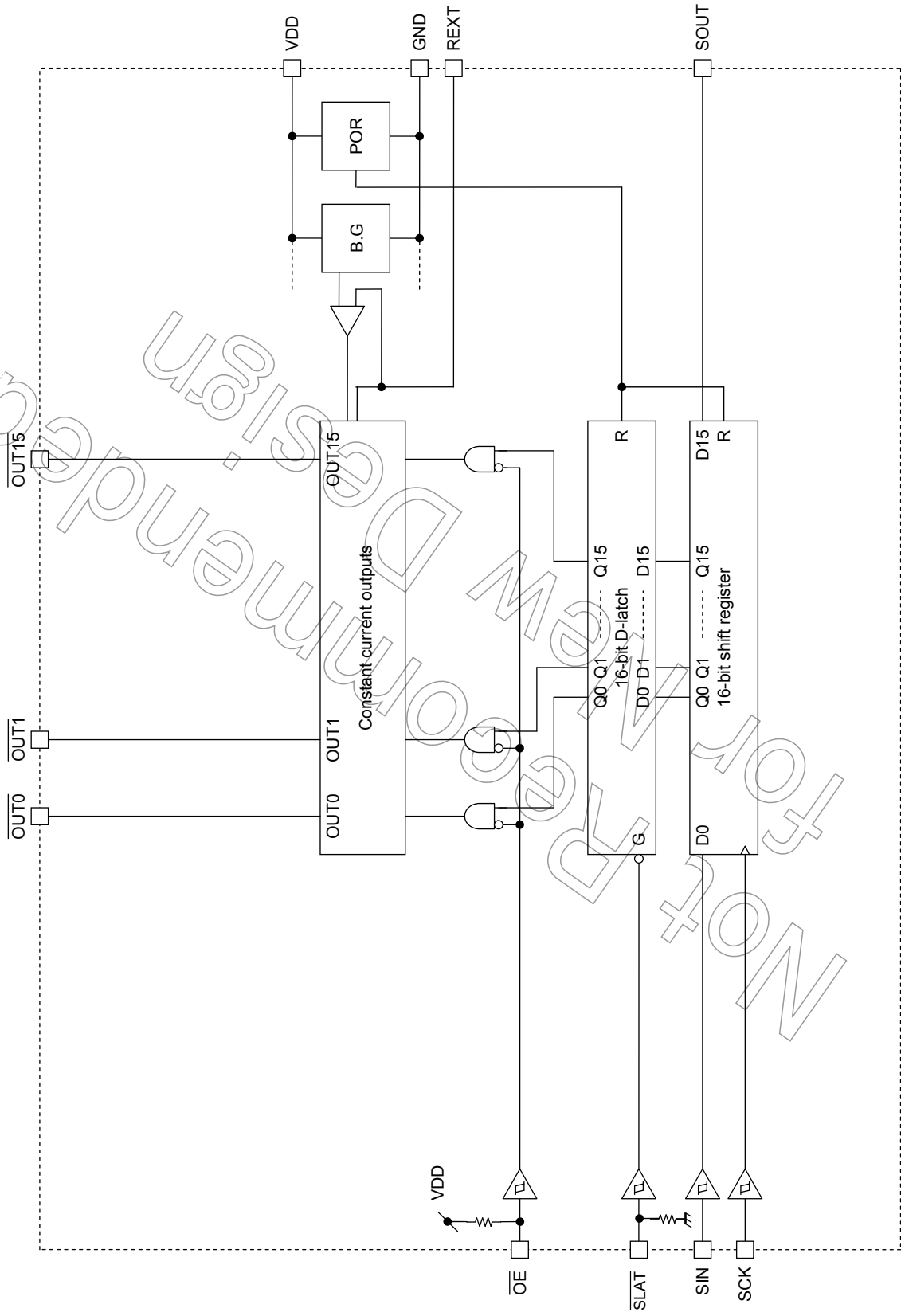

Pin Assignment (top view)

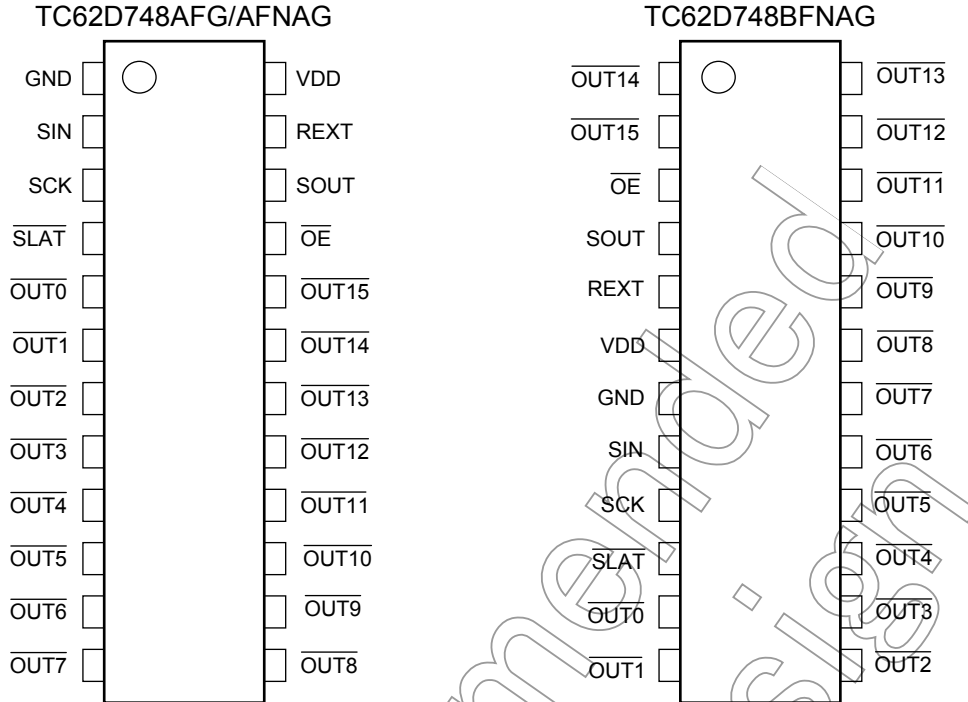

Note1: Short circuiting an output pin to a power supply pin (Power supply voltage V_{DD} and LED anode power supply), or short-circuiting the REXT pin to the GND pin will likely exceed the rating, which in turn may result in smoldering and/or permanent damage. Please keep this in mind when determining the wiring layout for the power supply and GND pins.

Pin Functions

Pin No		Pin Name	I/O	Function
AFG, AFNAG	BFNAG			
1	7	GND	—	The ground pin.
2	8	SIN	I	The serial data input pin.
3	9	SCK	I	The serial data transfer clock input pin.
4	10	SLAT	I	The latch signal input pin. Data is saved at L level.
5	11	$\overline{\text{OUT0}}$	O	A sink type constant current output pin.
6	12	$\overline{\text{OUT1}}$	O	A sink type constant current output pin.
7	13	$\overline{\text{OUT2}}$	O	A sink type constant current output pin.
8	14	$\overline{\text{OUT3}}$	O	A sink type constant current output pin.
9	15	$\overline{\text{OUT4}}$	O	A sink type constant current output pin.
10	16	$\overline{\text{OUT5}}$	O	A sink type constant current output pin.
11	17	$\overline{\text{OUT6}}$	O	A sink type constant current output pin.
12	18	$\overline{\text{OUT7}}$	O	A sink type constant current output pin.
13	19	$\overline{\text{OUT8}}$	O	A sink type constant current output pin.
14	20	$\overline{\text{OUT9}}$	O	A sink type constant current output pin.
15	21	$\overline{\text{OUT10}}$	O	A sink type constant current output pin.
16	22	$\overline{\text{OUT11}}$	O	A sink type constant current output pin.
17	23	$\overline{\text{OUT12}}$	O	A sink type constant current output pin.
18	24	$\overline{\text{OUT13}}$	O	A sink type constant current output pin.
19	1	$\overline{\text{OUT14}}$	O	A sink type constant current output pin.
20	2	$\overline{\text{OUT15}}$	O	A sink type constant current output pin.
21	3	$\overline{\text{OE}}$	I	The constant current output enable signal input pin. During the "H" level, the output will be forced off.
22	4	SOUT	O	The serial data output pin.
23	5	REXT	—	The constant current value setting resistor connection pin.
24	6	VDD	—	The power supply input pin.

I/O Equivalent Circuits

1. SCK, SIN

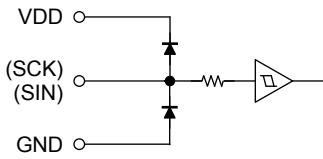

2. \overline{OE}

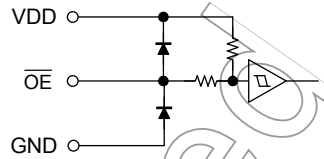

3. \overline{SLAT}

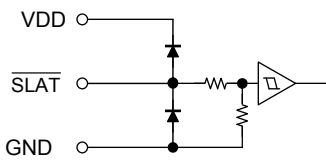

4. SOUT

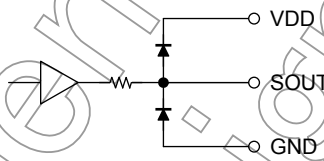

5. $\overline{OUT0}$ to $\overline{OUT15}$

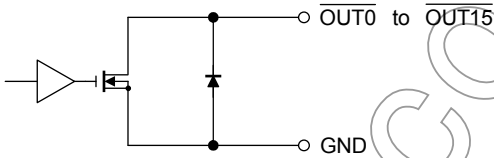

Not Recommended for New Design

Truth Table

SCK	$\overline{\text{SLAT}}$	$\overline{\text{OE}}$	SIN	$\overline{\text{OUT0}} \dots \overline{\text{OUT7}} \dots \overline{\text{OUT15}}^*1$	SOUT
\uparrow	H	L	Dn	Dn ... Dn - 7 ... Dn - 15	Dn - 15
\uparrow	L	L	Dn + 1	No Change	Dn - 14
\uparrow	H	L	Dn + 2	Dn + 2 ... Dn - 5 ... Dn - 13	Dn - 13
\downarrow	*2	L	Dn + 3	Dn + 2 ... Dn - 5 ... Dn - 13	Dn - 13
\downarrow	*2	H	Dn + 3	OFF	Dn - 13

Note1: When $\overline{\text{OUT0}}$ to $\overline{\text{OUT15}}$ output pins are set to "H" the respective output will be ON and when set to "L" the respective output will be OFF.

Note2: "*" is irrelevant to the truth table.

Timing Diagram

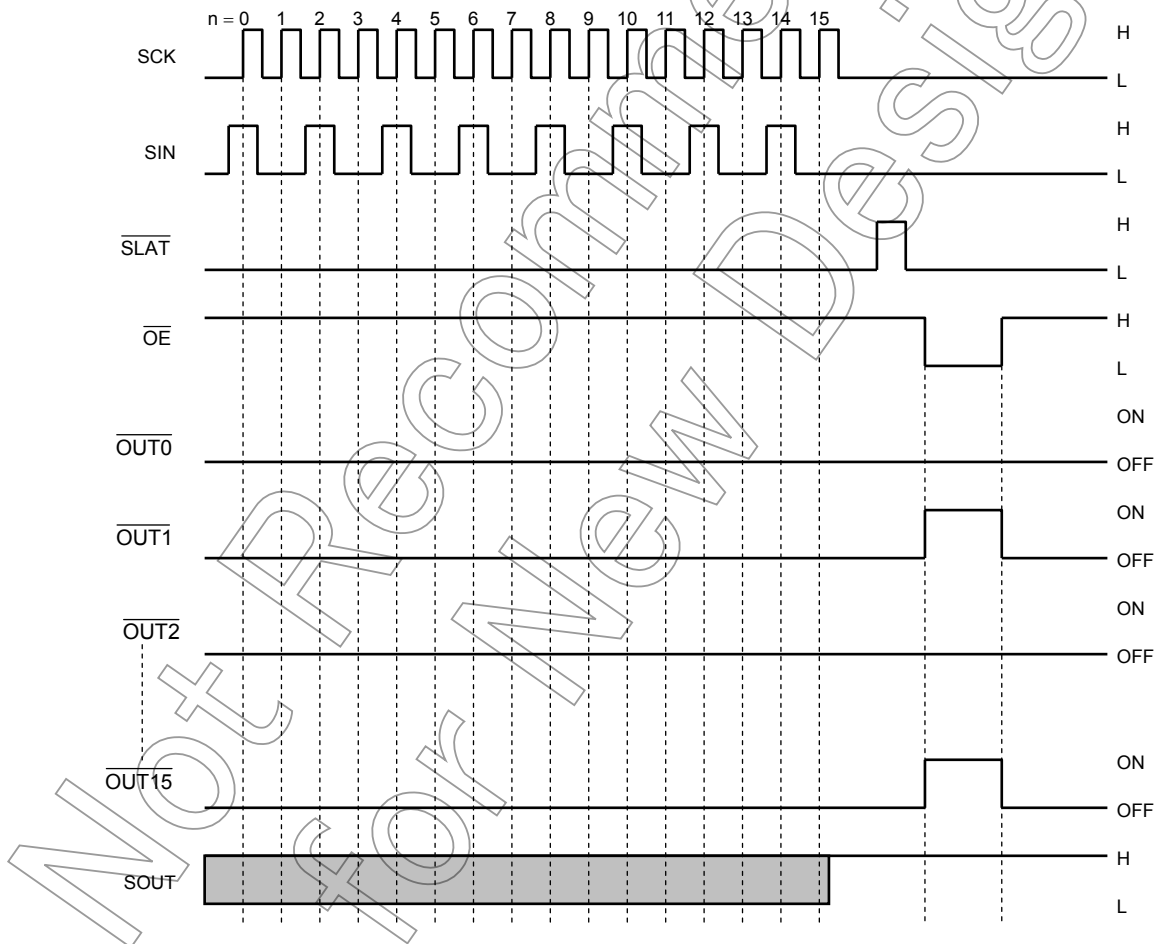

- The latch circuit is a leveled-latch circuit. Please exercise precaution as it is not triggered-latch circuit.
- Keep the $\overline{\text{SLAT}}$ pin is set to "L" to enable the latch circuit to hold data. In addition, when the $\overline{\text{SLAT}}$ pin is set to "H" the latch circuit does not hold data. The data will instead pass onto output. When the $\overline{\text{OE}}$ pin is set to "L" the $\overline{\text{OUT0}}$ to $\overline{\text{OUT15}}$ output pins will go ON and OFF in response to the data. In addition, when the $\overline{\text{OE}}$ pin is set to "H" all the output pins will be forced OFF regardless of the data.
- This product can use 3.3V and 5.0V power supply, but power supply and input (SCK/SIN/ $\overline{\text{SLAT}}$ / $\overline{\text{OE}}$) must use same voltage.

Absolute Maximum Ratings (T_a = 25°C)

Characteristics	Symbol	Rating *1	Unit
Power supply voltage	V _{DD}	-0.3 to 6.0	V
Output current	I _{OUT}	95	mA
Logic input voltage	V _{IN}	-0.3 to V _{DD} + 0.3*2	V
Output voltage	V _{OUT}	-0.3 to 17	V
Operating temperature	T _{opr}	-40 to 85	°C
Storage temperature	T _{stg}	-55 to 150	°C
Thermal resistance	R _{th(j-a)}	94 (AFG) *3, 80.07(AFNAG/BFNAG) When mounted PCB	°C/W
Power dissipation	P _D *4	1.32 (AFG) *3, 1.56(AFNAG/BFNAG) When mounted PCB	W

Note1: Voltage is ground referenced.

Note2: Do not exceed 6.0V.

Note3: PCB condition 76.2 x 114.3 x 1.6 mm, Cu 30% (SEMI conforming)

Note4: The power dissipation decreases the reciprocal of the saturated thermal resistance (1/ R_{th(j-a)}) for each degree (1°C) that the ambient temperature is exceeded (T_a = 25°C).

Operating Conditions

DC Items (Unless otherwise specified, V_{DD} = 3.0 to 5.5 V, T_a = -40°C to 85°C)

Characteristics	Symbol	Test Conditions	Min	Typ.	Max	Unit
Power supply voltage	V _{DD}	—	3.0	—	5.5	V
High level logic input voltage	V _{IH}	SIN, SCK, $\overline{\text{SLAT}}$, $\overline{\text{OE}}$	0.7 × V _{DD}	—	V _{DD}	V
Low level logic input voltage	V _{IL}	SIN, SCK, $\overline{\text{SLAT}}$, $\overline{\text{OE}}$	GND	—	0.3 × V _{DD}	V
High level SOUT output current	I _{OH}	—	—	—	-1	mA
Low level SOUT output current	I _{OL}	—	—	—	1	mA
Constant current output	I _{OUT}	$\overline{\text{OUTn}}$	1.5	—	90	mA

AC Items (Unless otherwise specified, V_{DD} = 3.0 to 5.5 V, T_a = -40°C to 85°C)

Characteristics	Symbol	Test Circuits	Test Conditions	Min	Typ.	Max	Unit
Serial data transfer frequency	f _{SCK}	6	—	—	—	25	MHz
H o l d t i m e	t _{HOLD1}	6	—	5	—	—	ns
	t _{HOLD2}	6	—	5	—	—	ns
S e t u p t i m e	t _{SETUP1}	6	—	5	—	—	ns
	t _{SETUP2}	6	—	5	—	—	ns
Maximum clock rise time	t _r	6	*1	—	—	500	ns
Maximum clock fall time	t _f	6	*1	—	—	500	ns

Note1: If the device is connected in a cascade and the t_r/t_f of the clock waveform increases due to deceleration of the clock waveform, it may not be possible to achieve the timing required for data transfer. Please keep these timing conditions in mind when designing your application.

Electrical Characteristics (Unless otherwise specified, $V_{DD} = 3.3V$, $T_a = 25^\circ C$)

Characteristics	Symbol	Test Circuits	Test Conditions	Min	Typ.	Max	Unit
High level logic output voltage	V_{OH}	1	$I_{OH} = -1 \text{ mA}$	$V_{DD} - 0.4$	—	—	V
Low level logic output voltage	V_{OL}	1	$I_{OL} = +1 \text{ mA}$	—	—	0.4	V
High level logic input current	I_{IH}	2	$V_{IN} = V_{DD}, \overline{OE}, \text{SIN}, \text{SCK}$	—	—	1	μA
Low level logic input current	I_{IL}	3	$V_{IN} = \text{GND}, \overline{\text{SLAT}}, \text{SIN}, \text{SCK}$	—	—	-1	μA
Power supply current	I_{DD}	4	$R_{EXT} = 1.2 \text{ k}\Omega$, All output on	—	—	8.0	mA
Output current	I_{OUT}	5	$V_{DD} = 3.3 \text{ V}, V_{OUT} = 1.0 \text{ V}, R_{EXT} = 1.2 \text{ k}\Omega$, 1 output on	—	14.4	—	mA
Constant current error(Ch to Ch) (S rank)	$\Delta I_{OUT(Ch)}$	5	$V_{DD} = 3.3 \text{ V}, V_{OUT} = 1.0 \text{ V}, R_{EXT} = 1.2 \text{ k}\Omega$, 1 output on	—	—	± 1.5	%
Constant current error(IC to IC) (S rank)	$\Delta I_{OUT(IC)}$	5	$V_{DD} = 3.3 \text{ V}, V_{OUT} = 1.0 \text{ V}, R_{EXT} = 1.2 \text{ k}\Omega$, 1 output on	—	—	± 1.5	%
Constant current error(Ch to Ch) (N rank)	$\Delta I_{OUT(Ch)}$	5	$V_{DD} = 3.3 \text{ V}, V_{OUT} = 1.0 \text{ V}, R_{EXT} = 1.2 \text{ k}\Omega$, 1 output on	—	—	± 2.5	%
Constant current error(IC to IC) (N rank)	$\Delta I_{OUT(IC)}$	5	$V_{DD} = 3.3 \text{ V}, V_{OUT} = 1.0 \text{ V}, R_{EXT} = 1.2 \text{ k}\Omega$, 1 output on	—	—	± 2.5	%
Output OFF leak current	I_{OK}	5	$V_{DD} = 3.3 \text{ V}, V_{OUT} = 17 \text{ V}, R_{EXT} = 1.2 \text{ k}\Omega$	—	—	0.5	μA
Constant current power supply voltage regulation	%VDD	5	$V_{DD} = 3.0 \text{ to } 3.6 \text{ V}, V_{OUT} = 1.0 \text{ V}, R_{EXT} = 1.2 \text{ k}\Omega$, 1 output on	—	± 1	± 5	%/V
Constant current output voltage regulation	%VOUT	5	$V_{DD} = 3.3 \text{ V}, V_{OUT} = 1.0 \text{ to } 3.0 \text{ V}, R_{EXT} = 1.2 \text{ k}\Omega$, 1 output on	—	± 0.1	± 0.5	%/V
Pull-up resistor	R_{UP}	3	\overline{OE}	400	500	600	k Ω
Pull-down resistor	R_{DOWN}	2	$\overline{\text{SLAT}}$	400	500	600	k Ω

Not Recommended for New

Electrical Characteristics (Unless otherwise specified, VDD = 5.0V, Ta = 25°C)

Characteristics	Symbol	Test Circuits	Test Conditions	Min	Typ.	Max	Unit
High level logic output voltage	V _{OH}	1	I _{OH} = -1 mA	V _{DD} - 0.4	—	—	V
Low level logic output voltage	V _{OL}	1	I _{OL} = +1 mA	—	—	0.4	V
High level logic input current	I _{IH}	2	V _{IN} = V _{DD} , $\overline{\text{OE}}$, SIN, SCK	—	—	1	μA
Low level logic input current	I _{IL}	3	V _{IN} = GND, $\overline{\text{SLAT}}$, SIN, SCK	—	—	-1	μA
Power supply current	I _{DD}	4	R _{EXT} = 1.2 kΩ, All output on	—	—	8.0	mA
Output current	I _{OUT}	5	V _{DD} = 5.0 V, V _{OUT} = 1.0 V, R _{EXT} = 1.2 kΩ, 1 output on	—	14.4	—	mA
Constant current error(Ch to Ch) (S rank)	ΔI _{OUT(Ch)}	5	V _{DD} = 3.3 V, V _{OUT} = 1.0 V, R _{EXT} = 1.2 kΩ, 1 output on	—	—	±1.5	%
Constant current error(IC to IC) (S rank)	ΔI _{OUT(IC)}	5	V _{DD} = 3.3 V, V _{OUT} = 1.0 V, R _{EXT} = 1.2 kΩ, 1 output on	—	—	±1.5	%
Constant current error(Ch to Ch) (N rank)	ΔI _{OUT(Ch)}	5	V _{DD} = 5.0 V, V _{OUT} = 1.0 V, R _{EXT} = 1.2 kΩ, 1 output on	—	—	±2.5	%
Constant current error(IC to IC) (N rank)	ΔI _{OUT(IC)}	5	V _{DD} = 5.0 V, V _{OUT} = 1.0 V, R _{EXT} = 1.2 kΩ, 1 output on	—	—	±2.5	%
Output OFF leak current	I _{OK}	5	V _{DD} = 5.0 V, V _{OUT} = 17 V, R _{EXT} = 1.2 kΩ	—	—	0.5	μA
Constant current power supply voltage regulation	%V _{DD}	5	V _{DD} = 4.5 to 5.5 V, V _{OUT} = 1.0 V, R _{EXT} = 1.2 kΩ, 1 output on	—	±1	±5	%/V
Constant current output voltage regulation	%V _{OUT}	5	V _{DD} = 5.0 V, V _{OUT} = 1.0 to 3.0 V, R _{EXT} = 1.2 kΩ, 1 output on	—	±0.1	±0.5	%/V
Pull-up resistor	R _{UP}	3	$\overline{\text{OE}}$	400	500	600	kΩ
Pull-down resistor	R _{DOWN}	2	$\overline{\text{SLAT}}$	400	500	600	kΩ

Not Recommended for New Design

Switching Characteristics (Unless otherwise specified, $V_{DD} = 3.3V$, $T_a = 25^\circ C$)

Characteristics		Symbol	Test Circuits	Test Conditions	Min	Typ.	Max	Unit
Propagation delay t _i m _e	SCK- $\overline{OUT0}$	t _{pLH1}	6	$\overline{SLAT} = "H", \overline{OE} = "L"$	—	50	65	ns
	\overline{SLAT} - $\overline{OUT0}$	t _{pLH2}	6	$\overline{OE} = "L"$	—	50	65	ns
	\overline{OE} - $\overline{OUT0}$	t _{pLH3}	6	$\overline{SLAT} = "H"$	—	50	65	ns
	SCK-SOUT	t _{pLH}	6	C _L =10.5 pF	10	20	35	ns
	SCK- $\overline{OUT0}$	t _{pHL1}	6	$\overline{SLAT} = "H", \overline{OE} = "L"$	—	30	40	ns
	\overline{SLAT} - $\overline{OUT0}$	t _{pHL2}	6	$\overline{OE} = "L"$	—	30	40	ns
	\overline{OE} - $\overline{OUT0}$	t _{pHL3}	6	$\overline{SLAT} = "H"$	—	30	40	ns
	SCK-SOUT	t _{pHL}	6	C _L =10.5 pF	10	20	35	ns
Output rise time	t _{or}	6	10 to 90% of voltage waveform	—	30	45	ns	
Output fall time	t _{of}	6	90 to 10% of voltage waveform	—	10	20	ns	
Enable pulse width	t _{wOE(L)}	6	$\overline{OE} = "L"$	25	—	—	ns	
	t _{wOE(H)}	6	$\overline{OE} = "H"$	50	—	—		
Clock pulse width	t _{wSCK}	6	SCK = "H" or "L"	20	—	—	ns	
Latch pulse width	t _{wSLAT}	6	$\overline{SLAT} = "H"$	20	—	—	ns	

Switching Characteristics (Unless otherwise specified, $V_{DD} = 5.0V$, $T_a = 25^\circ C$)

Characteristics		Symbol	Test Circuits	Test Conditions	Min	Typ.	Max	Unit
Propagation delay t _i m _e	SCK- $\overline{OUT0}$	t _{pLH1}	6	$\overline{SLAT} = "H", \overline{OE} = "L"$	—	50	65	ns
	\overline{SLAT} - $\overline{OUT0}$	t _{pLH2}	6	$\overline{OE} = "L"$	—	50	65	ns
	\overline{OE} - $\overline{OUT0}$	t _{pLH3}	6	$\overline{SLAT} = "H"$	—	50	65	ns
	SCK-SOUT	t _{pLH}	6	C _L =10.5 pF	10	20	35	ns
	SCK- $\overline{OUT0}$	t _{pHL1}	6	$\overline{SLAT} = "H", \overline{OE} = "L"$	—	30	40	ns
	\overline{SLAT} - $\overline{OUT0}$	t _{pHL2}	6	$\overline{OE} = "L"$	—	30	40	ns
	\overline{OE} - $\overline{OUT0}$	t _{pHL3}	6	$\overline{SLAT} = "H"$	—	30	40	ns
	SCK-SOUT	t _{pHL}	6	C _L =10.5 pF	10	20	35	ns
Output rise time	t _{or}	6	10 to 90% of voltage waveform	—	30	45	ns	
Output fall time	t _{of}	6	90 to 10% of voltage waveform	—	10	20	ns	
Enable pulse width	t _{wOE(L)}	6	$\overline{OE} = "L"$	25	—	—	ns	
	t _{wOE(H)}	6	$\overline{OE} = "H"$	50	—	—		
Clock pulse width	t _{wSCK}	6	SCK = "H" or "L"	20	—	—	ns	
Latch pulse width	t _{wSLAT}	6	$\overline{SLAT} = "H"$	20	—	—	ns	

Test Circuits

Test Circuit1: High level logic input voltage / Low level logic input voltage

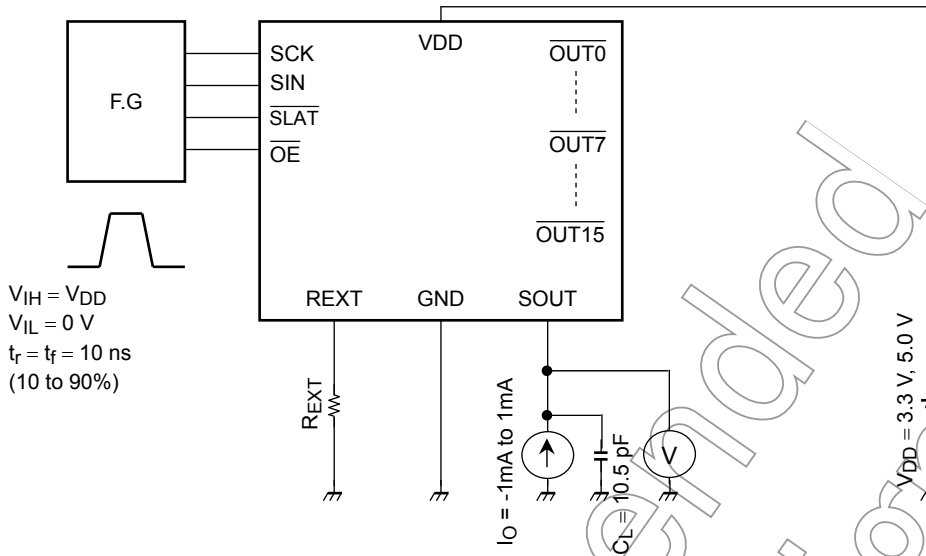

Test Circuit2: High level logic input current / Pull-down resistor

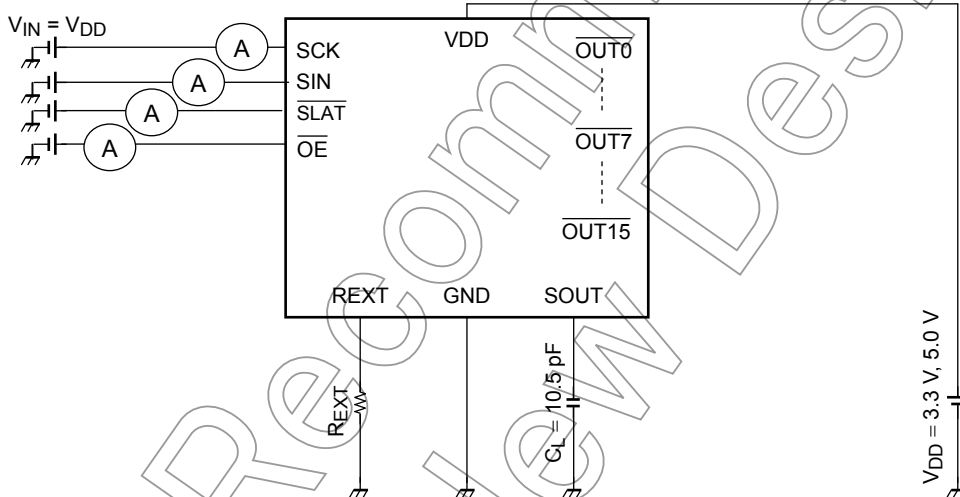

Test Circuit3: Low level logic input current / Pull-up resistor

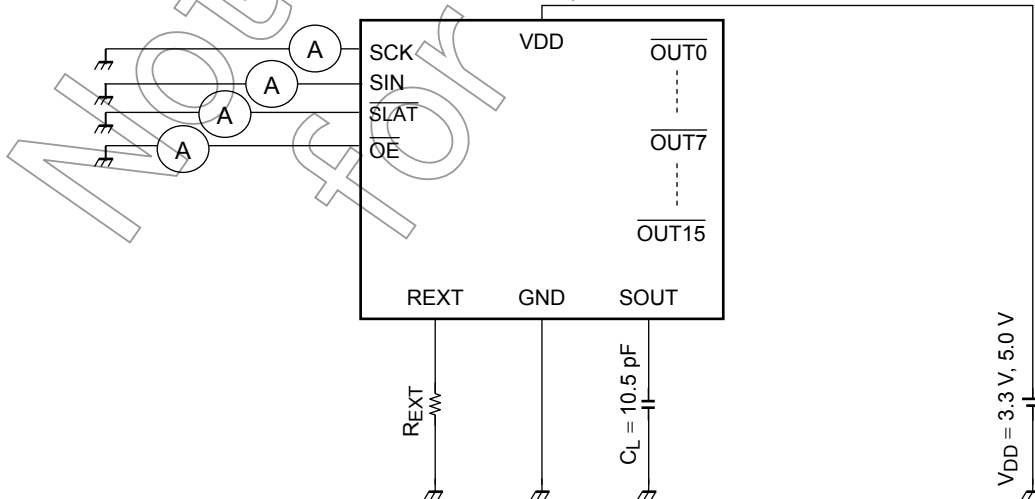

Test Circuit4: Power supply current

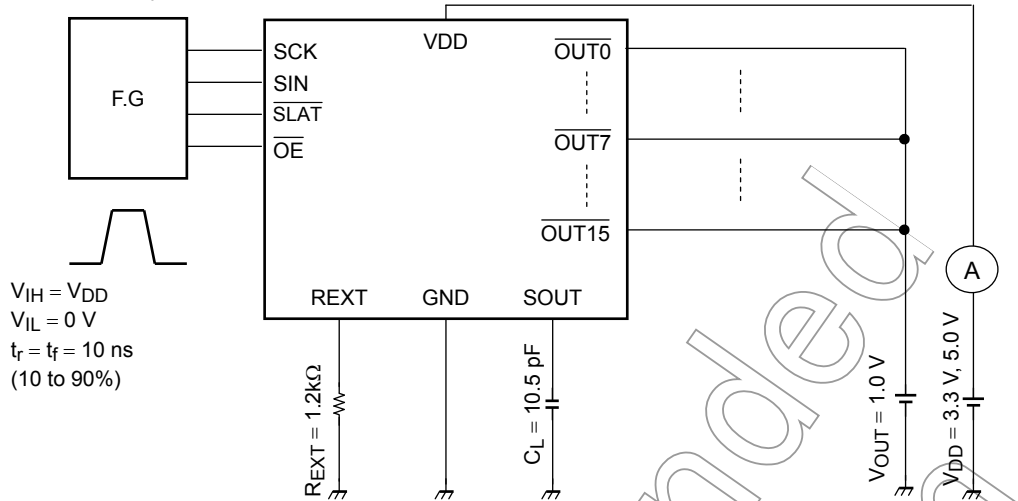

Test Circuit5: Constant current output / Output OFF leak current / Constant current error
 Constant current power supply voltage regulation / Constant current output voltage regulation

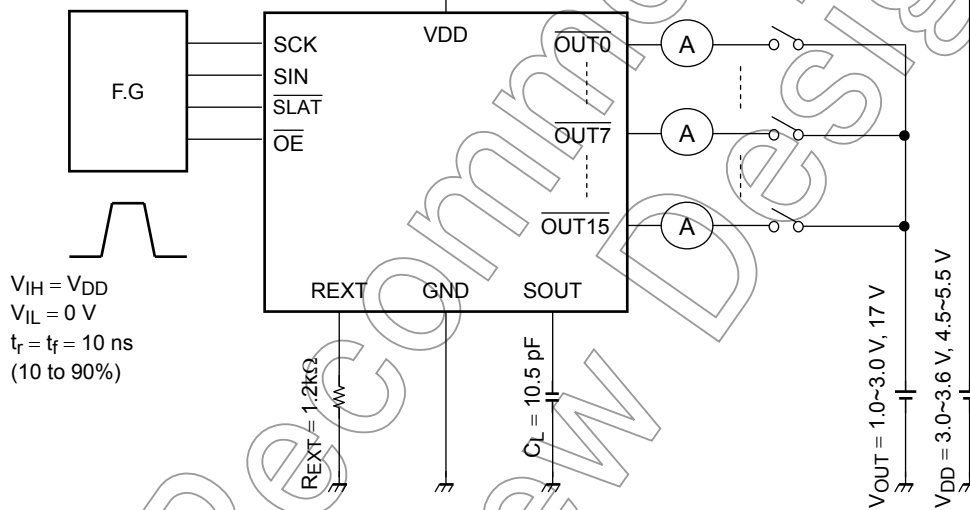

Test Circuit6: Switching Characteristics

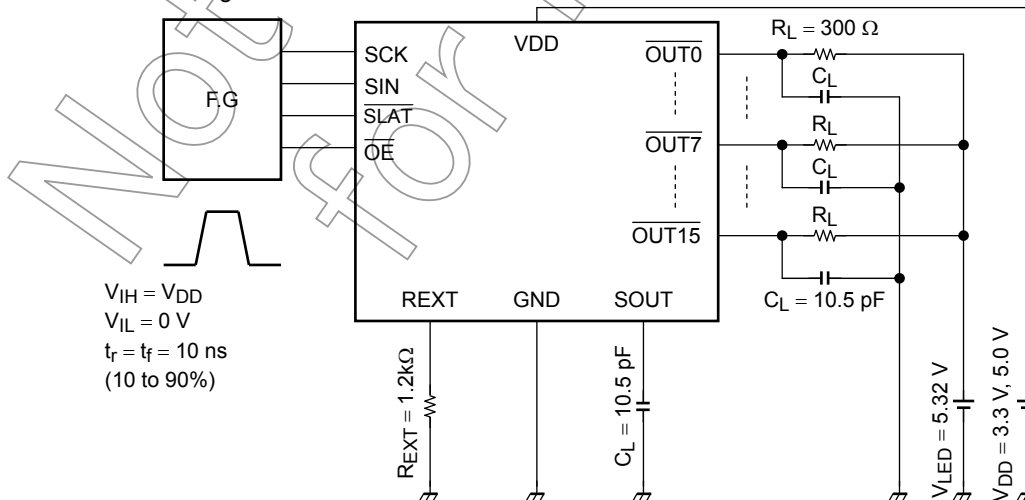

Timing Waveforms

1. SCK, SIN, SOUT

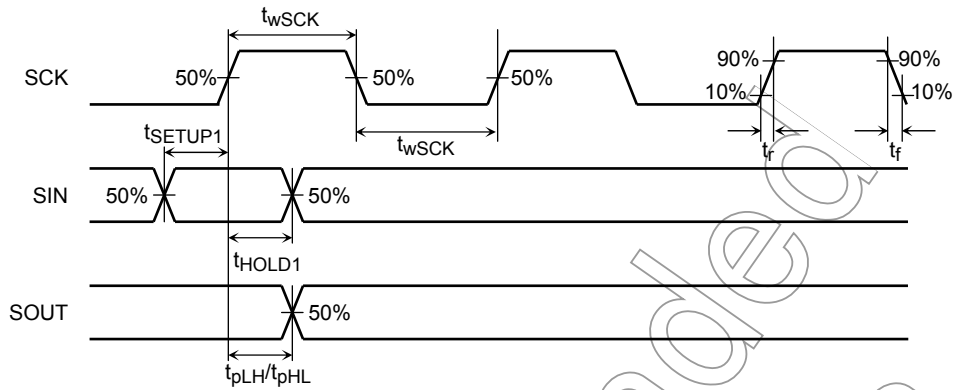

2. SCK, SIN, \overline{SLAT} , \overline{OE} , $\overline{OUT0}$

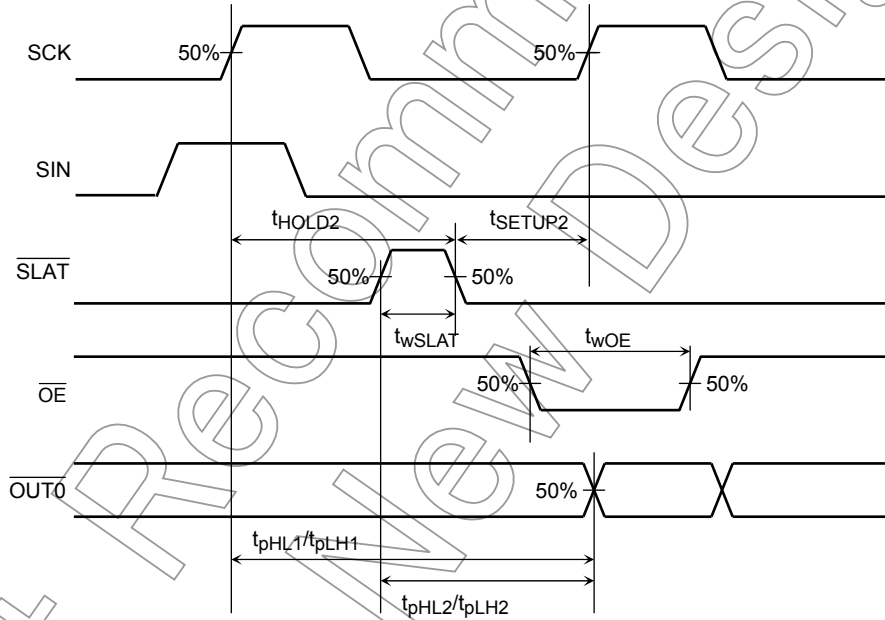

3. \overline{OE} , $\overline{OUT0} \sim \overline{OUT15}$

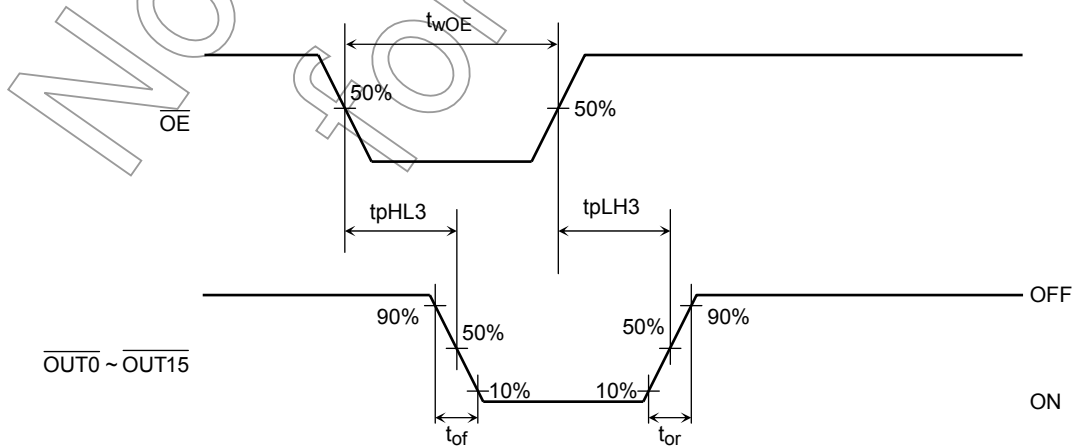

Power on reset (POR)

It avoids the malfunction by resetting all internal data of IC and setting default in startup.

POR circuit operates only when V_{DD} rises from 0 V. To restart POR, V_{DD} should be 0.5 V or less.

As for the voltage of storing the internal data, it is guaranteed after V_{DD} reaches 3.0 V or more once.

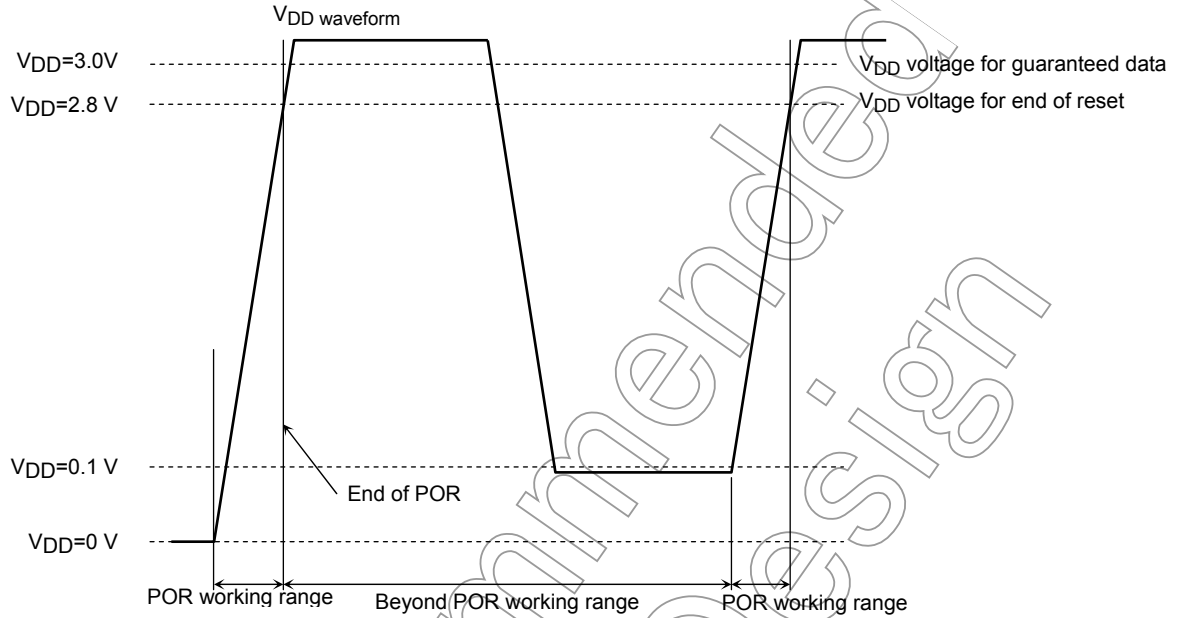

Not Recommended for New Design

Reference data

*This data is provided for reference only. Thorough evaluation and testing should be implemented when designing your application's mass production design.

Output Current (I_{OUT}) – Output current setting resistance (R_{EXT})

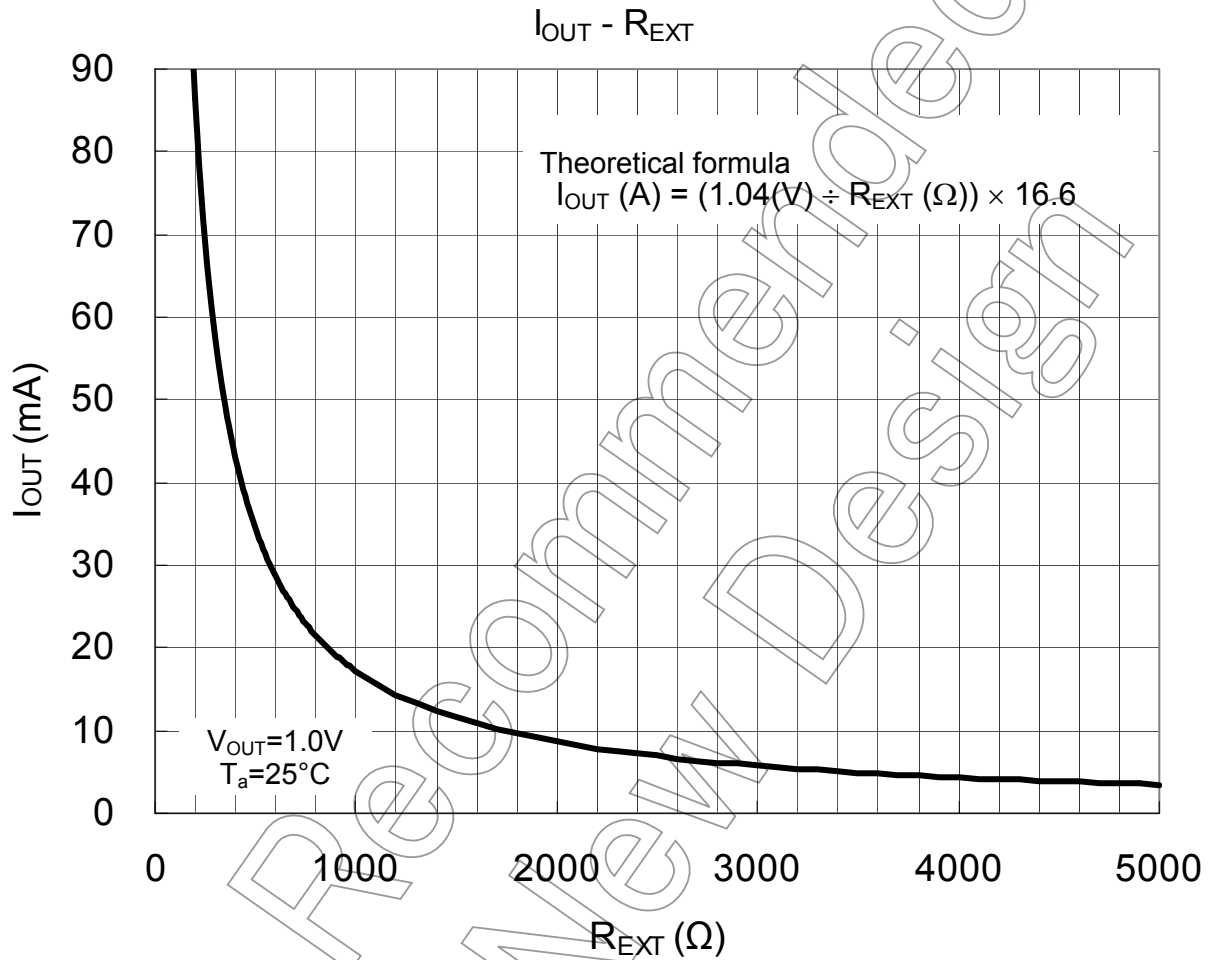

Reference data

*This data is provided for reference only. Thorough evaluation and testing should be implemented when designing your application's mass production design.

Output current (I_{OUT}) – Output voltage (V_{OUT})

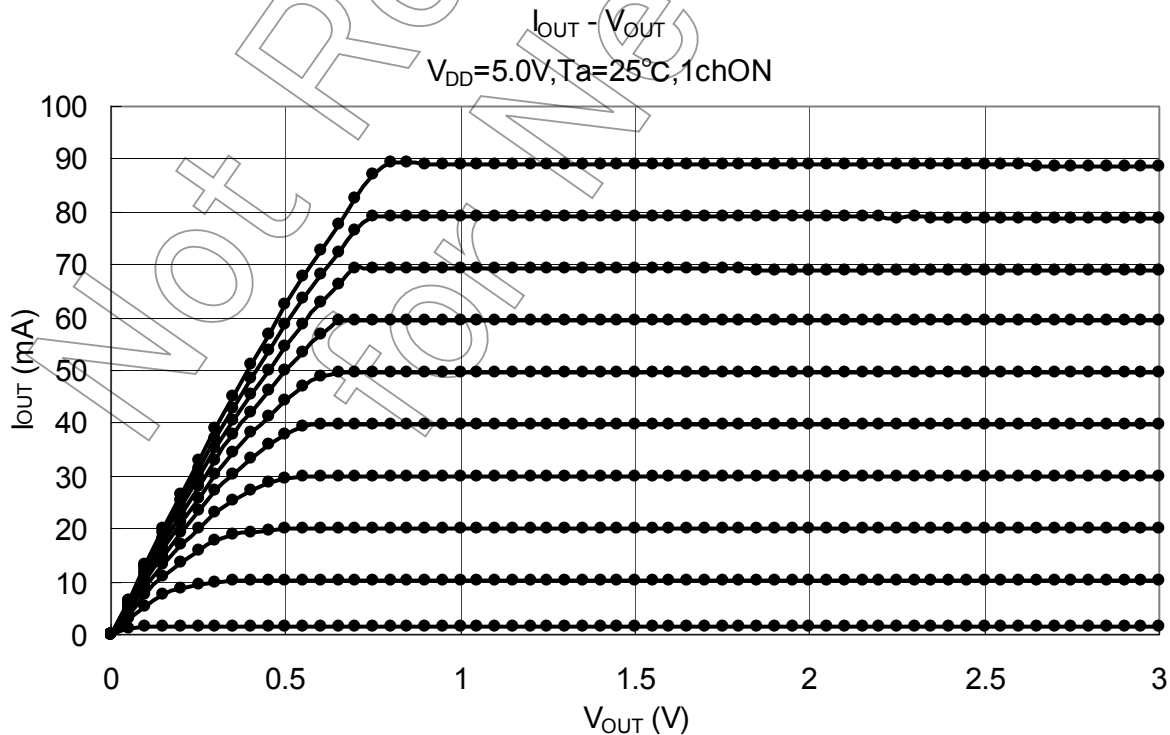
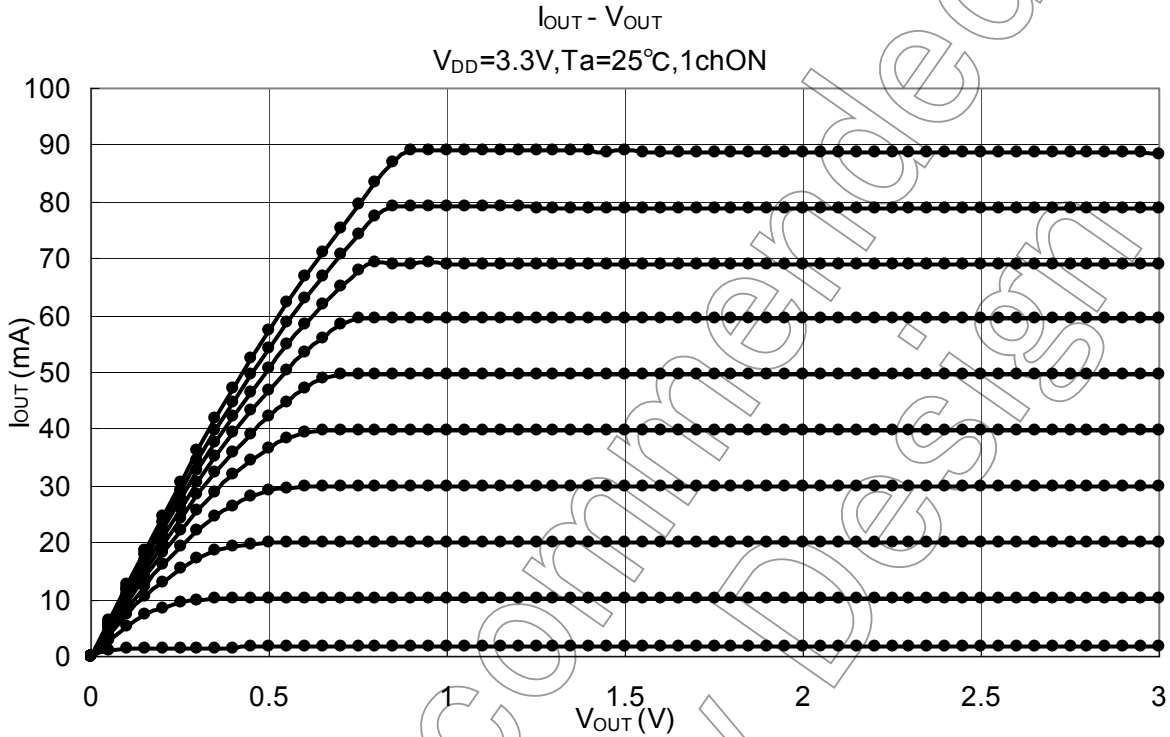

Application Circuit: General Composition for Static Lighting of LEDs

In the following diagram, it is recommended that the LED supply voltage (V_{LED}) be equal to or greater than the sum of V_f (max) of all LEDs plus 1.0 V.

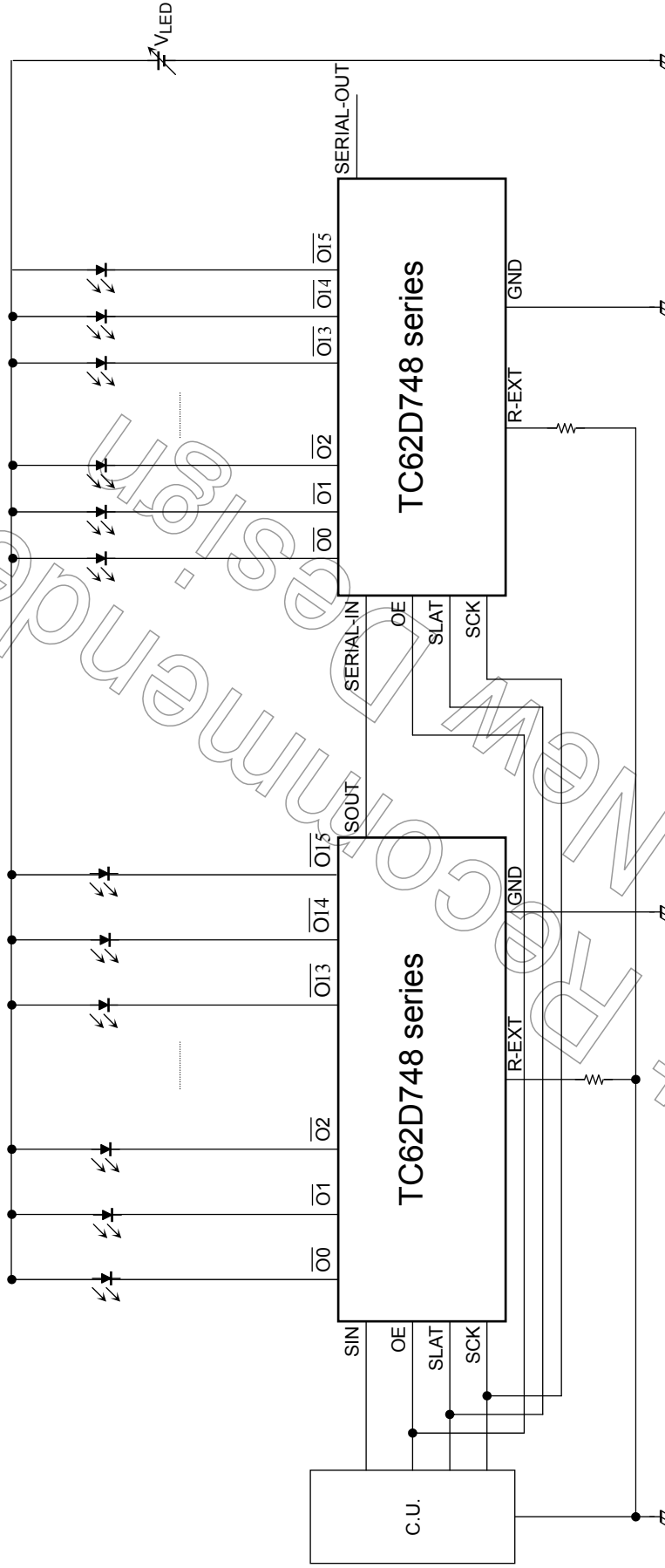

Application Circuit: General Composition for Dynamic Lighting of LEDs

In the following diagram, it is recommended that the LED supply voltage (V_{LED}) be equal to or greater than the sum of V_f (max) of all LEDs plus 1.0 V.

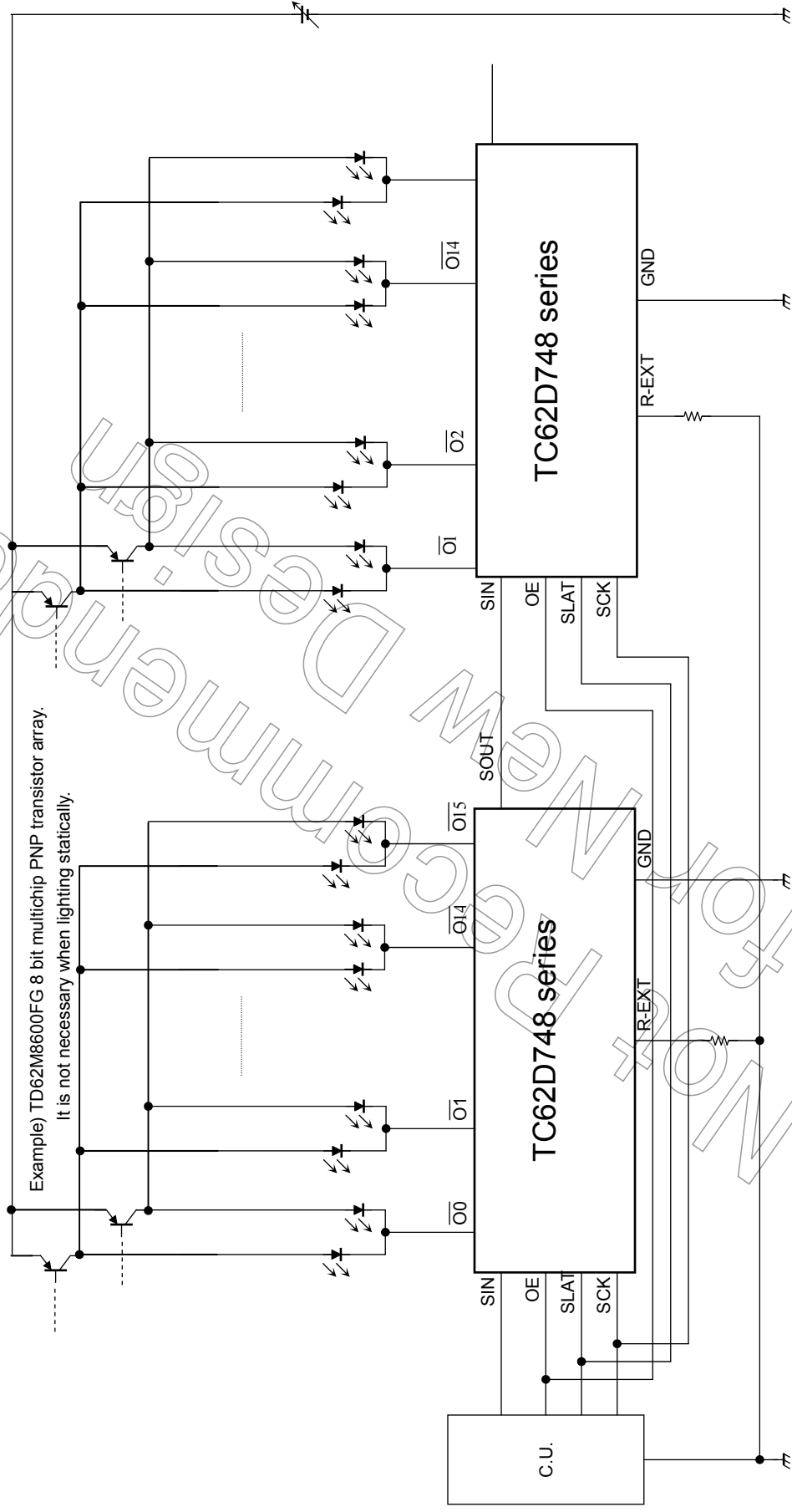

Notes on design of ICs

1. Power on sequence

After power is on, data setting will be available in 10 μ s when V_{DD} exceeds 3.0 V. Please input serial data transfer frequency(SCK),serial data(SIN),latch($\overline{\text{SLAT}}$) in 10 μ s when V_{DD} exceeds 3.0 V.

Power on sequence

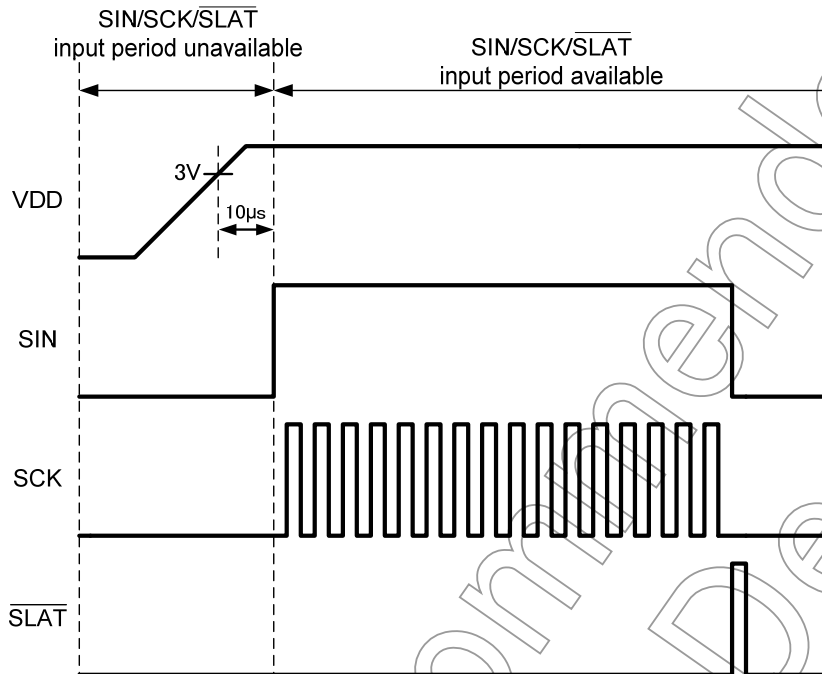

2. Regarding decoupling capacitor between power supply and GND
It is recommended that decoupling capacitor between power supply and GND should place as near IC as possible.
3. Regarding resistors for setting of output current
When resistors for setting of output current (R_{ext}) are used commonly by many ICS, in designing for mass production, take enough care in evaluating IC operation.
4. Regarding PCB layout
There is only one GND terminal on this device when the inductance in the GND line and the resistor are large, the device may malfunction due to the GND noise when output switching by the circuit board pattern and wiring.
Therefore, take care when designing the circuit board pattern layout and the wiring from the controller.
5. Please check the latest technical material at the time of mass production,

Package Dimensions

SSOP24-P-300-1.00B

Unit : mm

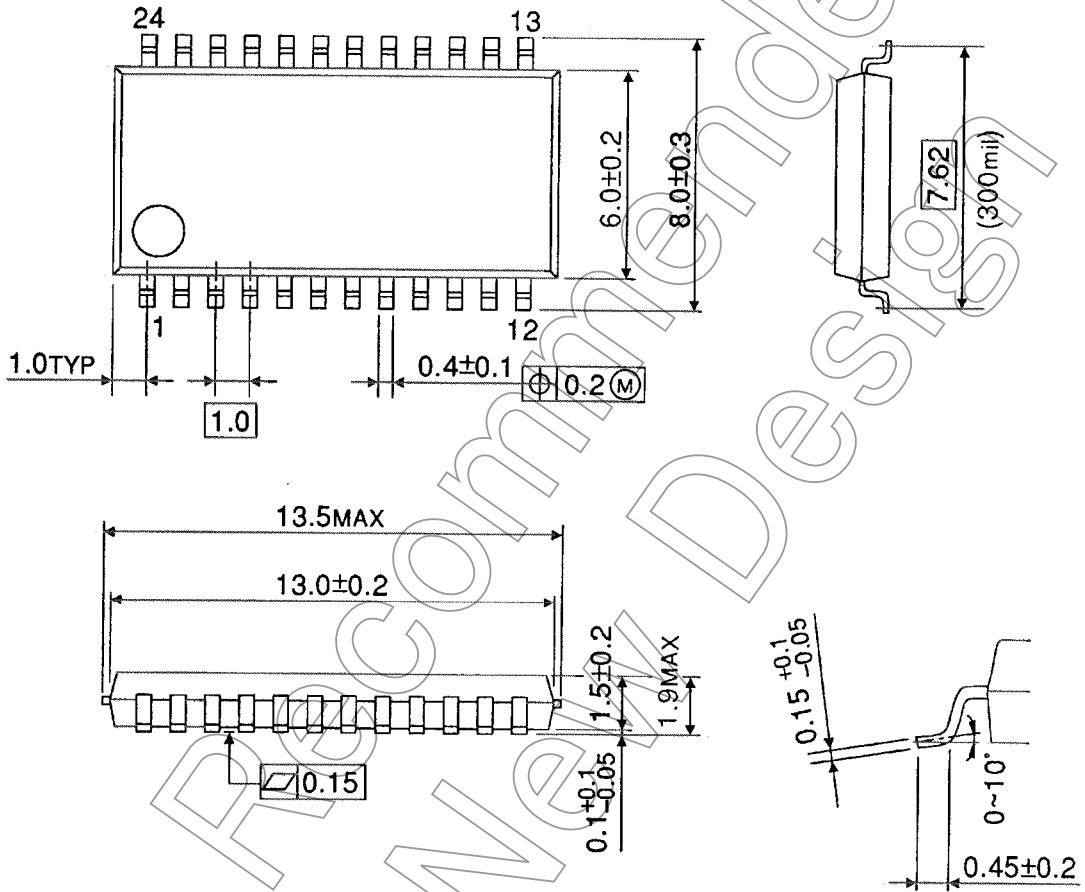

Weight: 0.29 g (typ.)

Package Dimensions

SSOP24-P-150-0.64

Unit : Inch

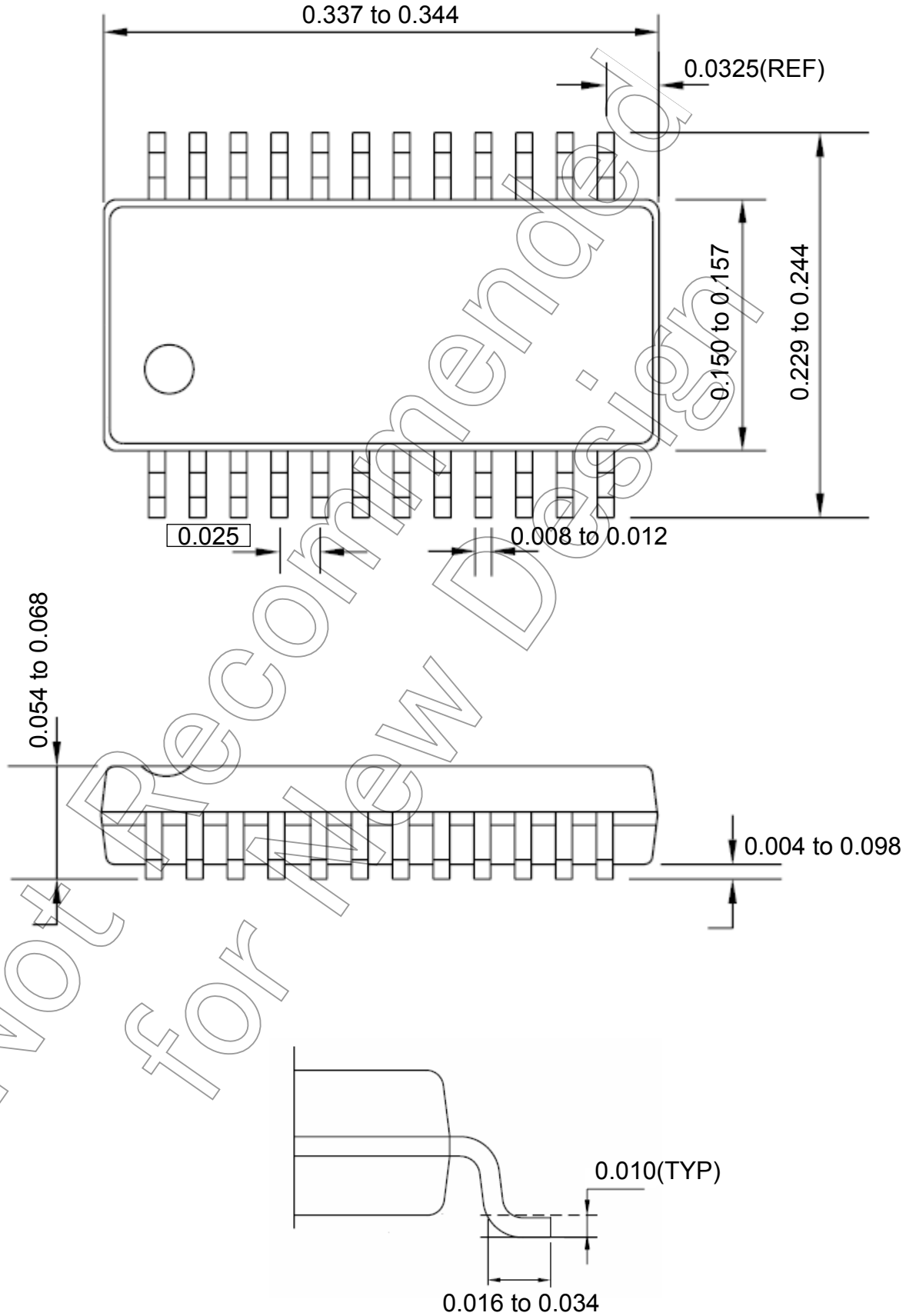

Weight: 0.14 g (typ.)

Notes on Contents**1. Block Diagrams**

Some of the functional blocks, circuits, or constants in the block diagram may be omitted or simplified for explanatory purposes.

2. Equivalent Circuits

The equivalent circuit diagrams may be simplified or some parts of them may be omitted for explanatory purposes.

3. Timing Charts

Timing charts may be simplified for explanatory purposes.

4. Application Circuits

The application circuits shown in this document are provided for reference purposes only. Thorough evaluation is required, especially at the mass production design stage.

Toshiba does not grant any license to any industrial property rights by providing these examples of application circuits.

5. Test Circuits

Components in the test circuits are used only to obtain and confirm the device characteristics. These components and circuits are not guaranteed to prevent malfunction or failure from occurring in the application equipment.

Not Recommended
for New Design

IC Usage Considerations

Notes on handling of ICs

- [1] The absolute maximum ratings of a semiconductor device are a set of ratings that must not be exceeded, even for a moment. Do not exceed any of these ratings.
Exceeding the rating(s) may cause the device breakdown, damage or deterioration, and may result injury by explosion or combustion.
- [2] Use an appropriate power supply fuse to ensure that a large current does not continuously flow in case of over current and/or IC failure. The IC will fully break down when used under conditions that exceed its absolute maximum ratings, when the wiring is routed improperly or when an abnormal pulse noise occurs from the wiring or load, causing a large current to continuously flow and the breakdown can lead smoke or ignition. To minimize the effects of the flow of a large current in case of breakdown, appropriate settings, such as fuse capacity, fusing time and insertion circuit location, are required.
- [3] If your design includes an inductive load such as a motor coil, incorporate a protection circuit into the design to prevent device malfunction or breakdown caused by the current resulting from the inrush current at power ON or the negative current resulting from the back electromotive force at power OFF. IC breakdown may cause injury, smoke or ignition.
Use a stable power supply with ICs with built-in protection functions. If the power supply is unstable, the protection function may not operate, causing IC breakdown. IC breakdown may cause injury, smoke or ignition.
- [4] Do not insert devices in the wrong orientation or incorrectly.
Make sure that the positive and negative terminals of power supplies are connected properly.
Otherwise, the current or power consumption may exceed the absolute maximum rating, and exceeding the rating(s) may cause the device breakdown, damage or deterioration, and may result injury by explosion or combustion.
In addition, do not use any device that is applied the current with inserting in the wrong orientation or incorrectly even just one time.
- [5] Carefully select external components (such as inputs and negative feedback capacitors) and load components (such as speakers), for example, power amp and regulator.
If there is a large amount of leakage current such as input or negative feedback condenser, the IC output DC voltage will increase. If this output voltage is connected to a speaker with low input withstand voltage, overcurrent or IC failure can cause smoke or ignition. (The over current can cause smoke or ignition from the IC itself.) In particular, please pay attention when using a Bridge Tied Load (BTL) connection type IC that inputs output DC voltage to a speaker directly.

Points to remember on handling of ICs

- (1) Heat Radiation Design
In using an IC with large current flow such as power amp, regulator or driver, please design the device so that heat is appropriately radiated, not to exceed the specified junction temperature (T_J) at any time and condition. These ICs generate heat even during normal use. An inadequate IC heat radiation design can lead to decrease in IC life, deterioration of IC characteristics or IC breakdown. In addition, please design the device taking into considerate the effect of IC heat radiation with peripheral components.
- (2) Back-EMF
When a motor rotates in the reverse direction, stops or slows down abruptly, a current flow back to the motor's power supply due to the effect of back-EMF. If the current sink capability of the power supply is small, the device's motor power supply and output pins might be exposed to conditions beyond maximum ratings. To avoid this problem, take the effect of back-EMF into consideration in system design.

About solderability, following conditions were confirmed**Solderability**

- (1) Use of Sn-37Pb solder Bath
 - solder bath temperature: 230°C
 - dipping time: 5 seconds
 - the number of times: once
 - use of R-type flux
- (2) Use of Sn-3.0Ag-0.5Cu solder Bath
 - solder bath temperature: 245°C
 - dipping time: 5 seconds
 - the number of times: once
 - use of R-type flux

Not Recommended
for New Design

RESTRICTIONS ON PRODUCT USE

- Toshiba Corporation, and its subsidiaries and affiliates (collectively "TOSHIBA"), reserve the right to make changes to the information in this document, and related hardware, software and systems (collectively "Product") without notice.
- This document and any information herein may not be reproduced without prior written permission from TOSHIBA. Even with TOSHIBA's written permission, reproduction is permissible only if reproduction is without alteration/omission.
- Though TOSHIBA works continually to improve Product's quality and reliability, Product can malfunction or fail. Customers are responsible for complying with safety standards and for providing adequate designs and safeguards for their hardware, software and systems which minimize risk and avoid situations in which a malfunction or failure of Product could cause loss of human life, bodily injury or damage to property, including data loss or corruption. Before customers use the Product, create designs including the Product, or incorporate the Product into their own applications, customers must also refer to and comply with (a) the latest versions of all relevant TOSHIBA information, including without limitation, this document, the specifications, the data sheets and application notes for Product and the precautions and conditions set forth in the "TOSHIBA Semiconductor Reliability Handbook" and (b) the instructions for the application with which the Product will be used with or for. Customers are solely responsible for all aspects of their own product design or applications, including but not limited to (a) determining the appropriateness of the use of this Product in such design or applications; (b) evaluating and determining the applicability of any information contained in this document, or in charts, diagrams, programs, algorithms, sample application circuits, or any other referenced documents; and (c) validating all operating parameters for such designs and applications. **TOSHIBA ASSUMES NO LIABILITY FOR CUSTOMERS' PRODUCT DESIGN OR APPLICATIONS.**
- Product is intended for use in general electronics applications (e.g., computers, personal equipment, office equipment, measuring equipment, industrial robots and home electronics appliances) or for specific applications as expressly stated in this document. Product is neither intended nor warranted for use in equipment or systems that require extraordinarily high levels of quality and/or reliability and/or a malfunction or failure of which may cause loss of human life, bodily injury, serious property damage or serious public impact ("Unintended Use"). Unintended Use includes, without limitation, equipment used in nuclear facilities, equipment used in the aerospace industry, medical equipment, equipment used for automobiles, trains, ships and other transportation, traffic signaling equipment, equipment used to control combustions or explosions, safety devices, elevators and escalators, devices related to electric power, and equipment used in finance-related fields. Do not use Product for Unintended Use unless specifically permitted in this document.
- Do not disassemble, analyze, reverse-engineer, alter, modify, translate or copy Product, whether in whole or in part.
- Product shall not be used for or incorporated into any products or systems whose manufacture, use, or sale is prohibited under any applicable laws or regulations.
- The information contained herein is presented only as guidance for Product use. No responsibility is assumed by TOSHIBA for any infringement of patents or any other intellectual property rights of third parties that may result from the use of Product. No license to any intellectual property right is granted by this document, whether express or implied, by estoppel or otherwise.
- **ABSENT A WRITTEN SIGNED AGREEMENT, EXCEPT AS PROVIDED IN THE RELEVANT TERMS AND CONDITIONS OF SALE FOR PRODUCT, AND TO THE MAXIMUM EXTENT ALLOWABLE BY LAW, TOSHIBA (1) ASSUMES NO LIABILITY WHATSOEVER, INCLUDING WITHOUT LIMITATION, INDIRECT, CONSEQUENTIAL, SPECIAL, OR INCIDENTAL DAMAGES OR LOSS, INCLUDING WITHOUT LIMITATION, LOSS OF PROFITS, LOSS OF OPPORTUNITIES, BUSINESS INTERRUPTION AND LOSS OF DATA, AND (2) DISCLAIMS ANY AND ALL EXPRESS OR IMPLIED WARRANTIES AND CONDITIONS RELATED TO SALE, USE OF PRODUCT, OR INFORMATION, INCLUDING WARRANTIES OR CONDITIONS OF MERCHANTABILITY, FITNESS FOR A PARTICULAR PURPOSE, ACCURACY OF INFORMATION, OR NONINFRINGEMENT.**
- Do not use or otherwise make available Product or related software or technology for any military purposes, including without limitation, for the design, development, use, stockpiling or manufacturing of nuclear, chemical, or biological weapons or missile technology products (mass destruction weapons). Product and related software and technology may be controlled under the Japanese Foreign Exchange and Foreign Trade Law and the U.S. Export Administration Regulations. Export and re-export of Product or related software or technology are strictly prohibited except in compliance with all applicable export laws and regulations.
- Please contact your TOSHIBA sales representative for details as to environmental matters such as the RoHS compatibility of Product. Please use Product in compliance with all applicable laws and regulations that regulate the inclusion or use of controlled substances, including without limitation, the EU RoHS Directive. TOSHIBA assumes no liability for damages or losses occurring as a result of noncompliance with applicable laws and regulations.