

**XTR112**  
**XTR114**

## 4-20mA CURRENT TRANSMITTERS with Sensor Excitation and Linearization

### FEATURES

- LOW UNADJUSTED ERROR
- PRECISION CURRENT SOURCES  
XTR112: Two 250 $\mu$ A  
XTR114: Two 100 $\mu$ A
- RTD OR BRIDGE EXCITATION
- LINEARIZATION
- TWO OR THREE-WIRE RTD OPERATION
- LOW OFFSET DRIFT: 0.4 $\mu$ V/ $^{\circ}$ C
- LOW OUTPUT CURRENT NOISE: 30nA-p-p
- HIGH PSR: 110dB min
- HIGH CMR: 86dB min
- WIDE SUPPLY RANGE: 7.5V TO 36V
- SO-14 SOIC PACKAGE

### DESCRIPTION

The XTR112 and XTR114 are monolithic 4-20mA, two-wire current transmitters. They provide complete current excitation for high impedance platinum RTD temperature sensors and bridges, instrumentation amplifier, and current output circuitry on a single integrated circuit. The XTR112 has two 250 $\mu$ A current sources while the XTR114 has two 100 $\mu$ A sources for RTD excitation.

Versatile linearization circuitry provides a 2nd-order correction to the RTD, typically achieving a 40:1 improvement in linearity.

Instrumentation amplifier gain can be configured for a wide range of temperature or pressure measurements. Total unadjusted error of the complete current transmitter is low enough to permit use without adjustment in many applications. This includes zero output current drift, span drift and nonlinearity. The XTR112 and XTR114 operate on loop power supply voltages down to 7.5V.

Both are available in an SO-14 surface-mount package and are specified for the  $-40^{\circ}$ C to  $+85^{\circ}$ C industrial temperature range.

### APPLICATIONS

- INDUSTRIAL PROCESS CONTROL
- FACTORY AUTOMATION
- SCADA REMOTE DATA ACQUISITION
- REMOTE TEMPERATURE AND PRESSURE TRANSDUCERS

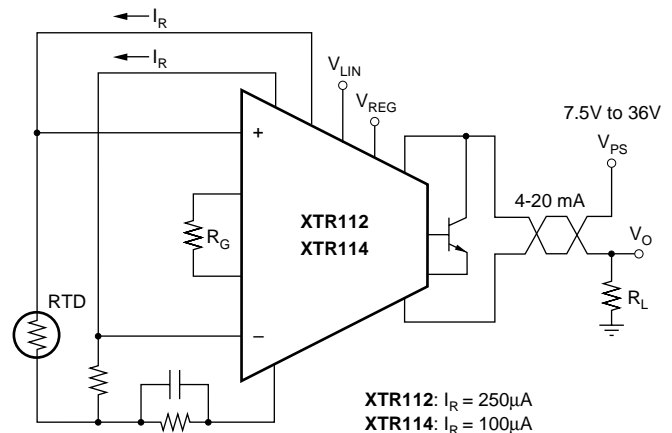
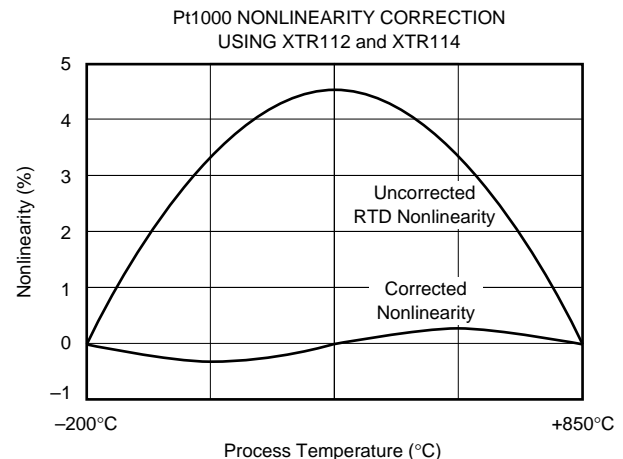

# SPECIFICATIONS

At  $T_A = +25^\circ\text{C}$ ,  $V_+ = 24\text{V}$ , and TIP29C external transistor, unless otherwise noted.

PARAMETER	CONDITIONS	XTR112U XTR114U			XTR112UA XTR114UA			UNITS
		MIN	TYP	MAX	MIN	TYP	MAX	
<b>OUTPUT</b> Output Current Equation Output Current, Specified Range Over-Scale Limit Under-Scale Limit: XTR112 XTR114	$I_{\text{REG}} = 0$	$I_O = V_{\text{IN}} \cdot (40/R_G) + 4\text{mA}$ , $V_{\text{IN}}$ in Volts, $R_G$ in $\Omega$						A
		4	20	*	*	*	mA	
		24	27	30	*	*	mA	
		0.9	1.3	1.7	*	*	mA	
		0.6	1	1.4	*	*	mA	
<b>ZERO OUTPUT</b> <sup>(1)</sup> Initial Error vs Temperature vs Supply Voltage, $V_+$ vs Common-Mode Voltage vs $V_{\text{REG}}$ Output Current Noise: 0.1Hz to 10Hz	$V_{\text{IN}} = 0\text{V}$ , $R_G = \infty$  $V_+ = 7.5\text{V}$ to $36\text{V}$ $V_{\text{CM}} = 1.25\text{V}$ to $3.5\text{V}$ <sup>(2)</sup>		4 $\pm 5$ $\pm 0.07$ 0.04 0.02 0.3 0.03	$\pm 25$ $\pm 0.5$ 0.2		*	$\pm 50$ $\pm 0.9$ *	mA $\mu\text{A}$ $\mu\text{A}/^\circ\text{C}$ $\mu\text{A}/\text{V}$ $\mu\text{A}/\text{V}$ $\mu\text{A}/\text{mA}$ $\mu\text{A}/\text{p-p}$
<b>SPAN</b> Span Equation (transconductance) Initial Error <sup>(3)</sup> vs Temperature <sup>(3)</sup> Nonlinearity: Ideal Input <sup>(4)</sup>	Full Scale ( $V_{\text{IN}}$ ) = 50mV  Full Scale ( $V_{\text{IN}}$ ) = 50mV		$S = 40/R_G$ $\pm 0.05$ $\pm 3$ 0.003	$\pm 0.2$ $\pm 25$ 0.01		*	$\pm 0.4$ * *	A/V % ppm/ $^\circ\text{C}$ %
<b>INPUT</b> <sup>(5)</sup> Offset Voltage vs Temperature vs Supply Voltage, $V_+$ vs Common-Mode Voltage, RTI (CMRR) Common-Mode Input Range <sup>(2)</sup> Input Bias Current vs Temperature Input Offset Current vs Temperature Impedance: Differential Common-Mode Noise: 0.1Hz to 10Hz	$V_{\text{CM}} = 2\text{V}$  $V_+ = 7.5\text{V}$ to $36\text{V}$ $V_{\text{CM}} = 1.25\text{V}$ to $3.5\text{V}$ <sup>(2)</sup>		$\pm 50$ $\pm 0.4$ $\pm 0.3$ $\pm 10$	$\pm 100$ $\pm 1.5$ $\pm 3$ $\pm 50$		*	$\pm 250$ $\pm 3$ * $\pm 100$	$\mu\text{V}$ $\mu\text{V}/^\circ\text{C}$ $\mu\text{V}/\text{V}$ $\mu\text{V}/\text{V}$
		1.25		3.5	*		*	V
			5 20	25		*	50	nA pA/ $^\circ\text{C}$
			$\pm 0.2$	$\pm 3$		*	$\pm 10$	nA
			5			*		pA/ $^\circ\text{C}$
			0.1    1 5    10 0.6			*		G $\Omega$    pF G $\Omega$    pF $\mu\text{V}/\text{p-p}$
<b>CURRENT SOURCES</b> Current: XTR112 XTR114 Accuracy vs Temperature vs Power Supply, $V_+$ Matching vs Temperature vs Power Supply, $V_+$ Compliance Voltage, Positive Negative <sup>(2)</sup> Output Impedance: XTR112 XTR114 Noise: 0.1Hz to 10Hz: XTR112 XTR114	$V_O = 2\text{V}$ <sup>(6)</sup>  $V_+ = 7.5\text{V}$ to $36\text{V}$  $V_+ = 7.5\text{V}$ to $36\text{V}$		250 100 $\pm 0.05$ $\pm 15$ $\pm 10$ $\pm 0.02$ $\pm 3$ 1	$\pm 0.2$ $\pm 35$ $\pm 25$ $\pm 0.1$ $\pm 15$ 10		*	$\pm 0.4$ $\pm 75$ * $\pm 0.2$ $\pm 30$ *	$\mu\text{A}$ $\mu\text{A}$ % ppm/ $^\circ\text{C}$ ppm/V % ppm/ $^\circ\text{C}$ ppm/V V V
		( $V_+$ ) -3 0	( $V_+$ ) -2.5 -0.2		*	*		V V
			500 1.2		*	*		M $\Omega$ G $\Omega$
			0.001 0.0004		*	*		$\mu\text{A}/\text{p-p}$ $\mu\text{A}/\text{p-p}$
<b><math>V_{\text{REG}}</math></b> <sup>(2)</sup> Accuracy vs Temperature vs Supply Voltage, $V_+$ Output Current: XTR112 XTR114 Output Impedance			5.1 $\pm 0.02$ $\pm 0.2$ 1 -1, +2.1 -1, +2.4 75	$\pm 0.1$		*	*	V V mV/ $^\circ\text{C}$ mV/V mA mA $\Omega$
<b>LINEARIZATION</b> $R_{\text{LIN}}$ (internal) Accuracy vs Temperature			1 $\pm 0.2$ $\pm 25$	$\pm 0.5$ $\pm 100$		*	$\pm 1$ *	k $\Omega$ % ppm/ $^\circ\text{C}$
<b>POWER SUPPLY</b> Specified Voltage Operating Voltage Range			+7.5	+24 +36		*	*	V V
<b>TEMPERATURE RANGE</b> Specification, $T_{\text{MIN}}$ to $T_{\text{MAX}}$ Operating/Storage Range Thermal Resistance, $\theta_{\text{JA}}$ SO-14 Surface-Mount			-40 -55	+85 +125		*	*	$^\circ\text{C}$ $^\circ\text{C}$ $^\circ\text{C}/\text{W}$

\* Specification same as XTR112U, XTR114U.

NOTES: (1) Describes accuracy of the 4mA low-scale offset current. Does not include input amplifier effects. Can be trimmed to zero. (2) Voltage measured with respect to  $I_{\text{RET}}$  pin. (3) Does not include initial error or TCR of gain-setting resistor,  $R_G$ . (4) Increasing the full-scale input range improves nonlinearity. (5) Does not include Zero Output initial error. (6) Current source output voltage with respect to  $I_{\text{RET}}$  pin.

## PIN CONFIGURATION

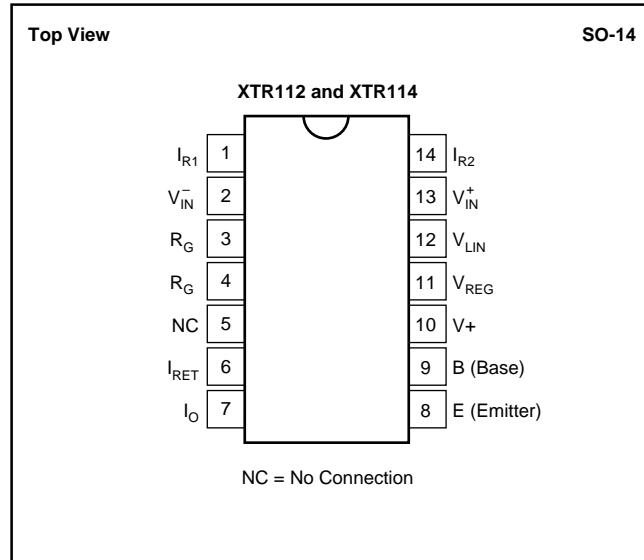

## ABSOLUTE MAXIMUM RATINGS<sup>(1)</sup>

Power Supply, $V_+$ (referenced to $I_O$ pin)	40V
Input Voltage, $V_{IN}^+$ , $V_{IN}^-$ (referenced to $I_O$ pin)	0V to $V_+$
Storage Temperature Range	-55°C to +125°C
Lead Temperature (soldering, 10s)	+300°C
Output Current Limit	Continuous
Junction Temperature	+165°C

NOTE: (1) Stresses above these ratings may cause permanent damage. Exposure to absolute maximum conditions for extended periods may degrade device reliability.



## ELECTROSTATIC DISCHARGE SENSITIVITY

This integrated circuit can be damaged by ESD. Burr-Brown recommends that all integrated circuits be handled with appropriate precautions. Failure to observe proper handling and installation procedures can cause damage.

ESD damage can range from subtle performance degradation to complete device failure. Precision integrated circuits may be more susceptible to damage because very small parametric changes could cause the device not to meet its published specifications.

## PACKAGE/ORDERING INFORMATION

PRODUCT	CURRENT SOURCES	PACKAGE	PACKAGE DRAWING NUMBER <sup>(1)</sup>	SPECIFIED TEMPERATURE RANGE	ORDERING NUMBER <sup>(2)</sup>	TRANSPORT MEDIA
XTR112U	2 x 250 $\mu$ A	SO-14 Surface Mount	235	-40°C to +85°C	XTR112U	Rails
"	"	"	"	"	XTR112U/2K5	Tape and Reel
XTR112UA	2 x 250 $\mu$ A	SO-14 Surface Mount	235	-40°C to +85°C	XTR112UA	Rails
"	"	"	"	"	XTR112UA/2K5	Tape and Reel
XTR114U	2 x 100 $\mu$ A	SO-14 Surface Mount	235	-40°C to +85°C	XTR114U	Rails
"	"	"	"	"	XTR114U/2K5	Tape and Reel
XTR114UA	2 x 100 $\mu$ A	SO-14 Surface Mount	235	-40°C to +85°C	XTR114UA	Rails
"	"	"	"	"	XTR114UA/2K5	Tape and Reel

NOTES: (1) For detailed drawing and dimension table, please see end of data sheet, or Appendix C of Burr-Brown IC Data Book. (2) Models with a slash (/) are available only in Tape and Reel in the quantities indicated (e.g., /2K5 indicates 2500 devices per reel). Ordering 2500 pieces of "XTR112UA/2K5" will get a single 2500-piece Tape and Reel. For detailed Tape and Reel mechanical information, refer to Appendix B of Burr-Brown IC Data Book.

The information provided herein is believed to be reliable; however, BURR-BROWN assumes no responsibility for inaccuracies or omissions. BURR-BROWN assumes no responsibility for the use of this information, and all use of such information shall be entirely at the user's own risk. Prices and specifications are subject to change without notice. No patent rights or licenses to any of the circuits described herein are implied or granted to any third party. BURR-BROWN does not authorize or warrant any BURR-BROWN product for use in life support devices and/or systems.

# FUNCTIONAL BLOCK DIAGRAM

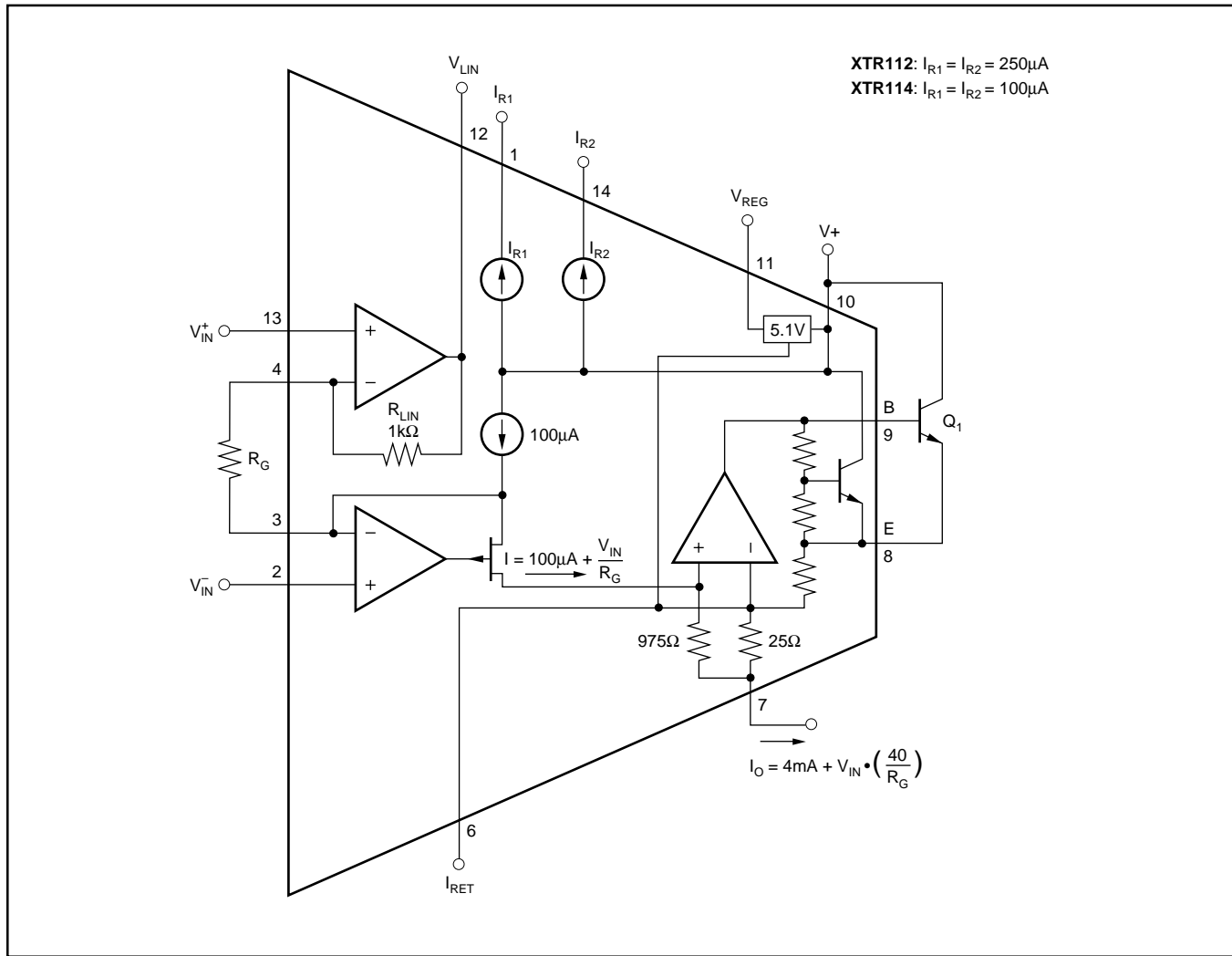

# TYPICAL PERFORMANCE CURVES

At  $T_A = +25^\circ\text{C}$ , and  $V_+ = 24\text{V}$ , unless otherwise noted.

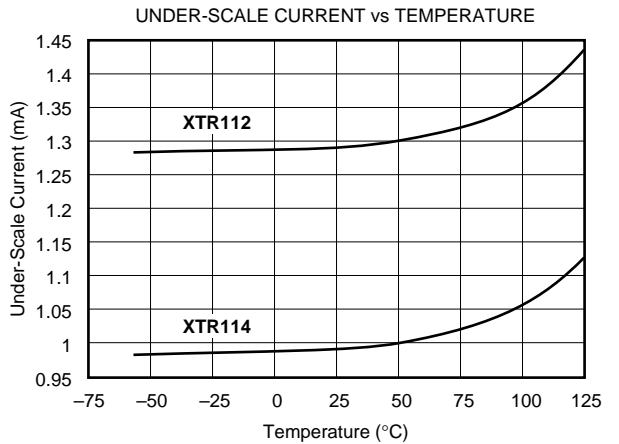
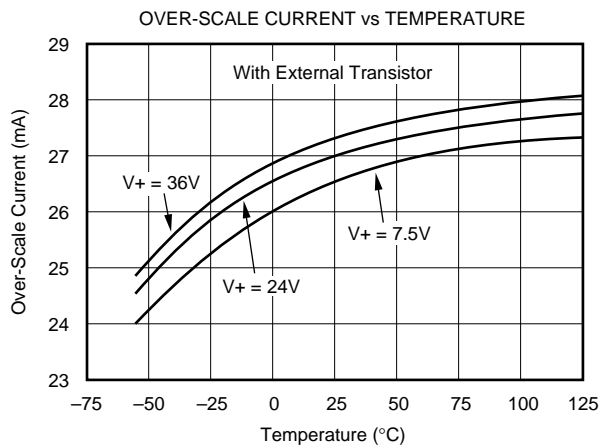
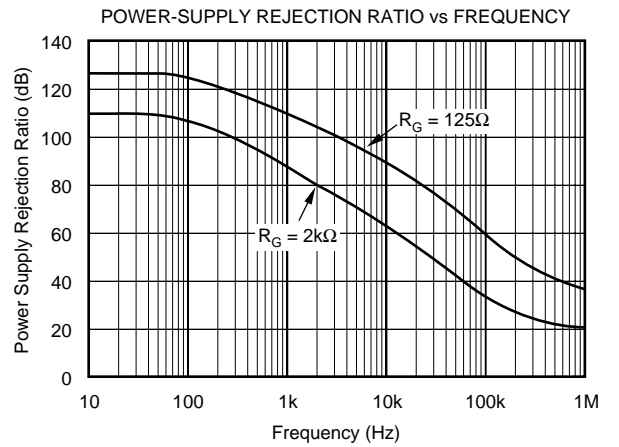
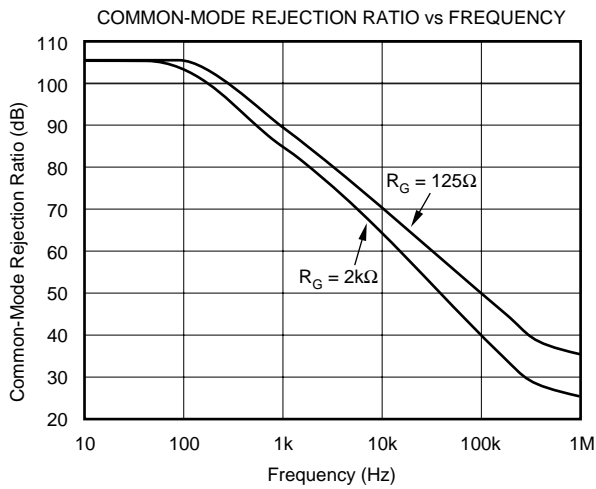
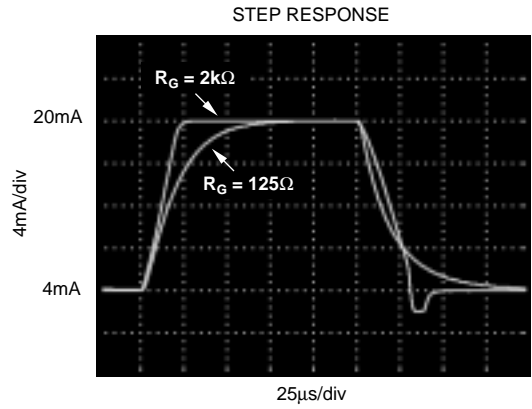
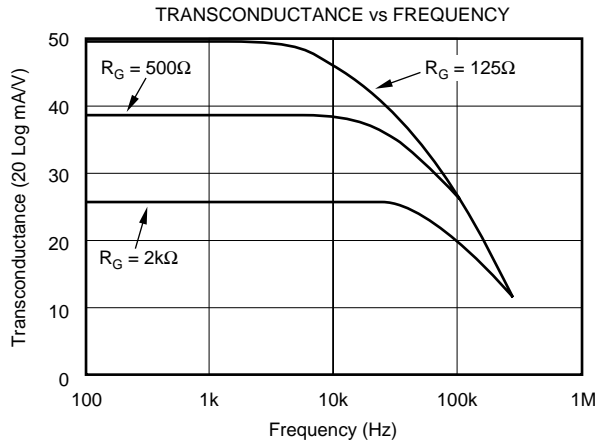

# TYPICAL PERFORMANCE CURVES (CONT)

At  $T_A = +25^\circ\text{C}$ , and  $V_+ = 24\text{V}$ , unless otherwise noted.

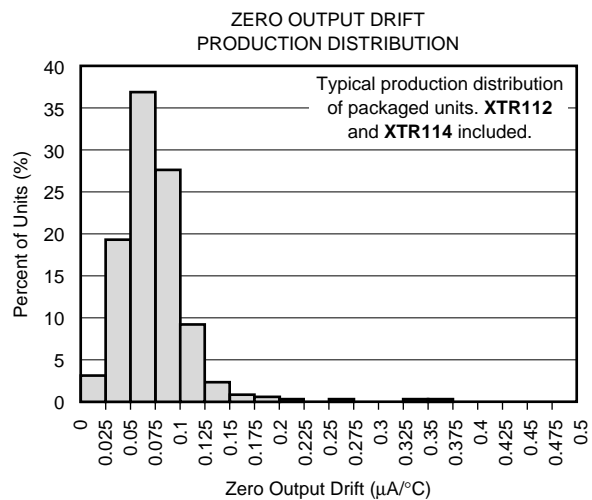
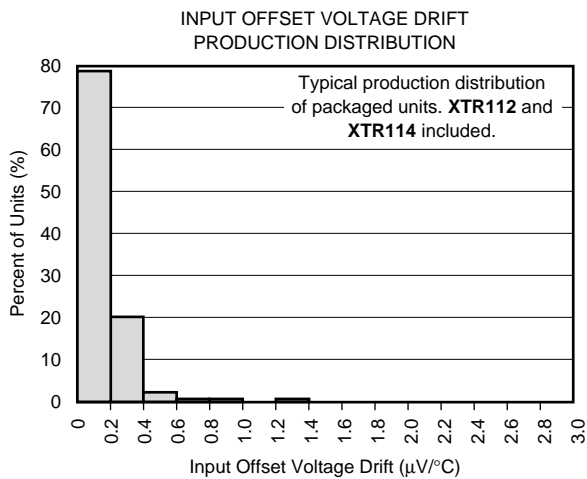
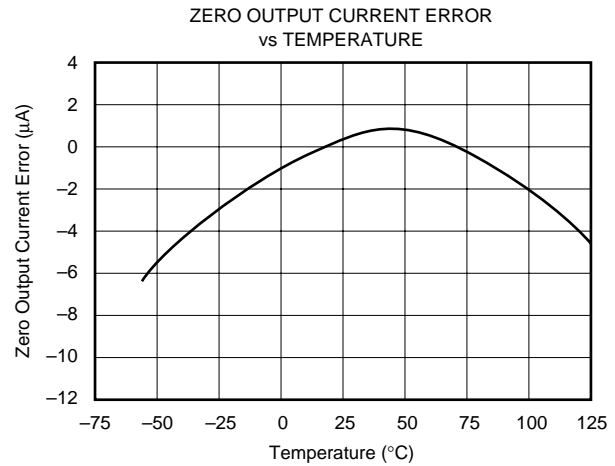
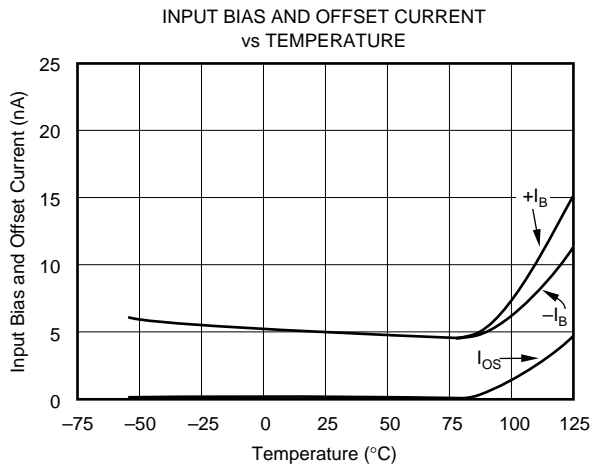
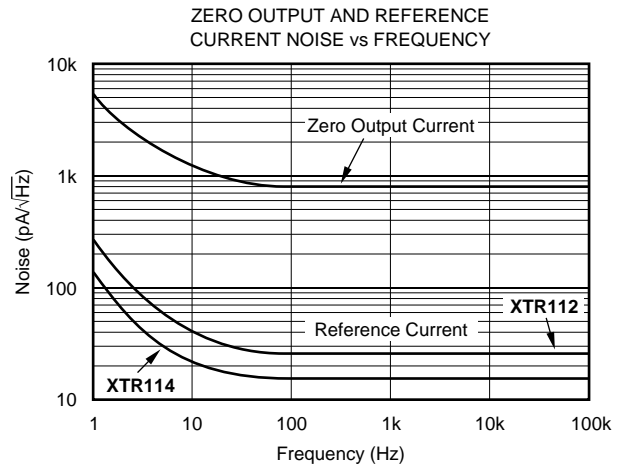
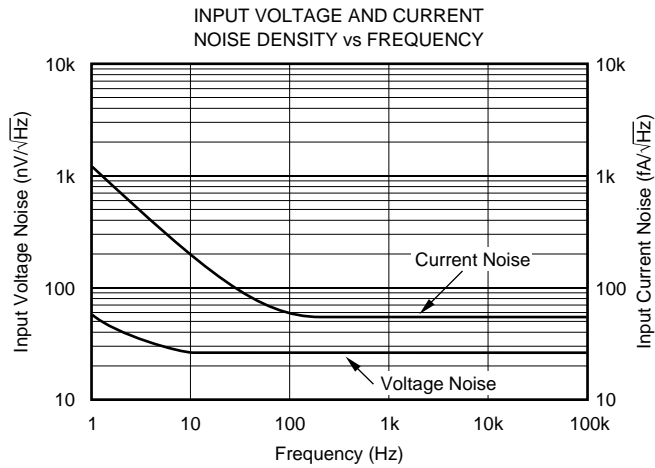

# TYPICAL PERFORMANCE CURVES (CONT)

At  $T_A = +25^\circ\text{C}$ , and  $V_+ = 24\text{V}$ , unless otherwise noted.

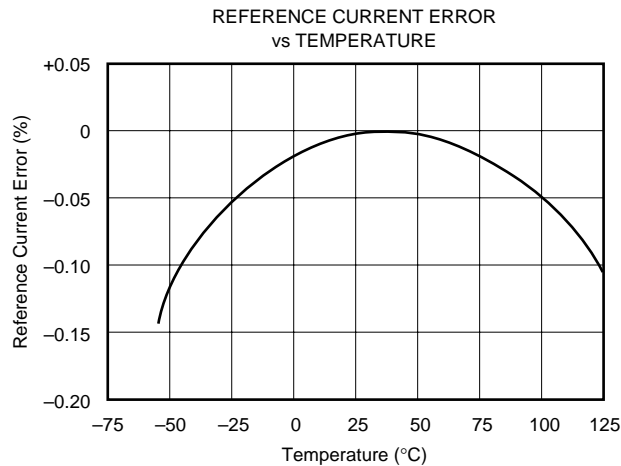
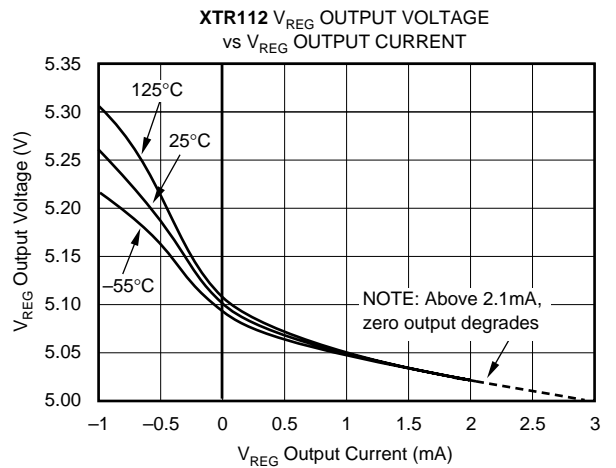
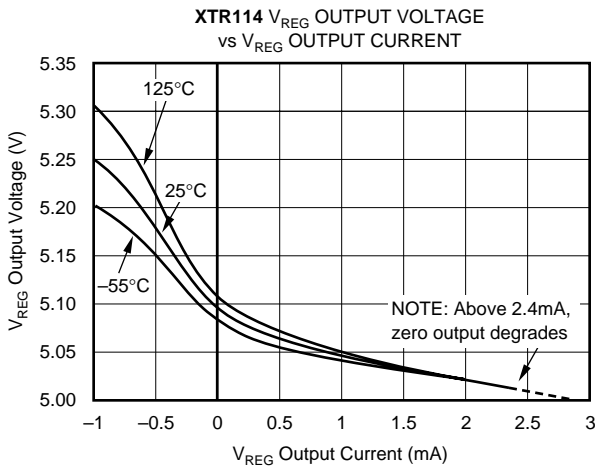
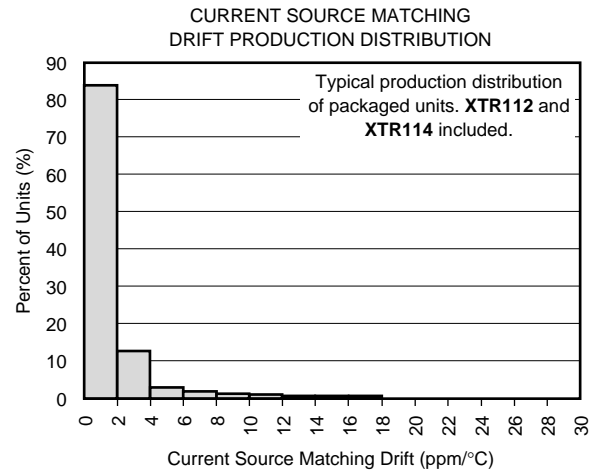
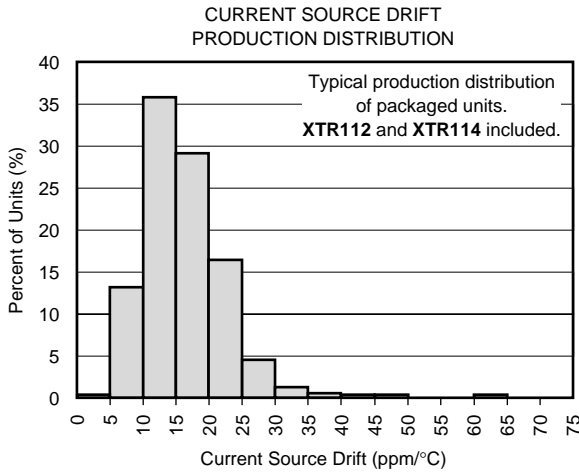

# APPLICATION INFORMATION

Figure 1 shows the basic connection diagram for the XTR112 and XTR114. The loop power supply,  $V_{PS}$ , provides power for all circuitry. Output loop current is measured as a voltage across the series load resistor,  $R_L$ .

Two matched current sources drive the RTD and zero-setting resistor,  $R_Z$ . These current sources are  $250\mu A$  for the XTR112 and  $100\mu A$  for the XTR114. Their instrumentation amplifier input measures the voltage difference between the RTD and  $R_Z$ . The value of  $R_Z$  is chosen to be equal to the resistance of the RTD at the low-scale (minimum) measurement temperature.  $R_Z$  can be adjusted to achieve 4mA output at the minimum measurement temperature to correct for input offset voltage and reference current mismatch of the XTR112 and XTR114.

$R_{CM}$  provides an additional voltage drop to bias the inputs of the XTR112 and XTR114 within their common-mode input range.  $R_{CM}$  should be bypassed with a  $0.01\mu F$  capacitor to minimize common-mode noise. Resistor  $R_G$  sets the gain of the instrumentation amplifier according to the desired temperature range.  $R_{LIN1}$  provides second-order linearization correction to the RTD, typically achieving a 40:1 improvement in linearity. An additional resistor is required for three-wire RTD connections, see Figure 3.

The transfer function through the complete instrumentation amplifier and voltage-to-current converter is:

$$I_O = 4mA + V_{IN} \cdot (40/R_G)$$

( $V_{IN}$  in volts,  $R_G$  in ohms)

where  $V_{IN}$  is the differential input voltage. As evident from the transfer function, if  $R_G$  is not used the gain is zero and the output is simply the XTR's zero current. The value of  $R_G$  varies slightly for two-wire RTD and three-wire RTD connections with linearization.  $R_G$  can be calculated from the equations given in Figure 1 (two-wire RTD connection) and Table I (three-wire RTD connection).

The  $I_{RET}$  pin is the return path for all current from the current sources and  $V_{REG}$ . The  $I_{RET}$  pin allows any current used in external circuitry to be sensed by the XTR112 and XTR114 and to be included in the output current without causing an error.

The  $V_{REG}$  pin provides an on-chip voltage source of approximately 5.1V and is suitable for powering external input circuitry (refer to Figure 6). It is a moderately accurate voltage reference—it is not the same reference used to set the precision current references.  $V_{REG}$  is capable of sourcing approximately 2.1mA of current for the XTR112 and 2.4mA for the XTR114. Exceeding these values may affect the 4mA zero output. Both products can sink approximately 1mA.

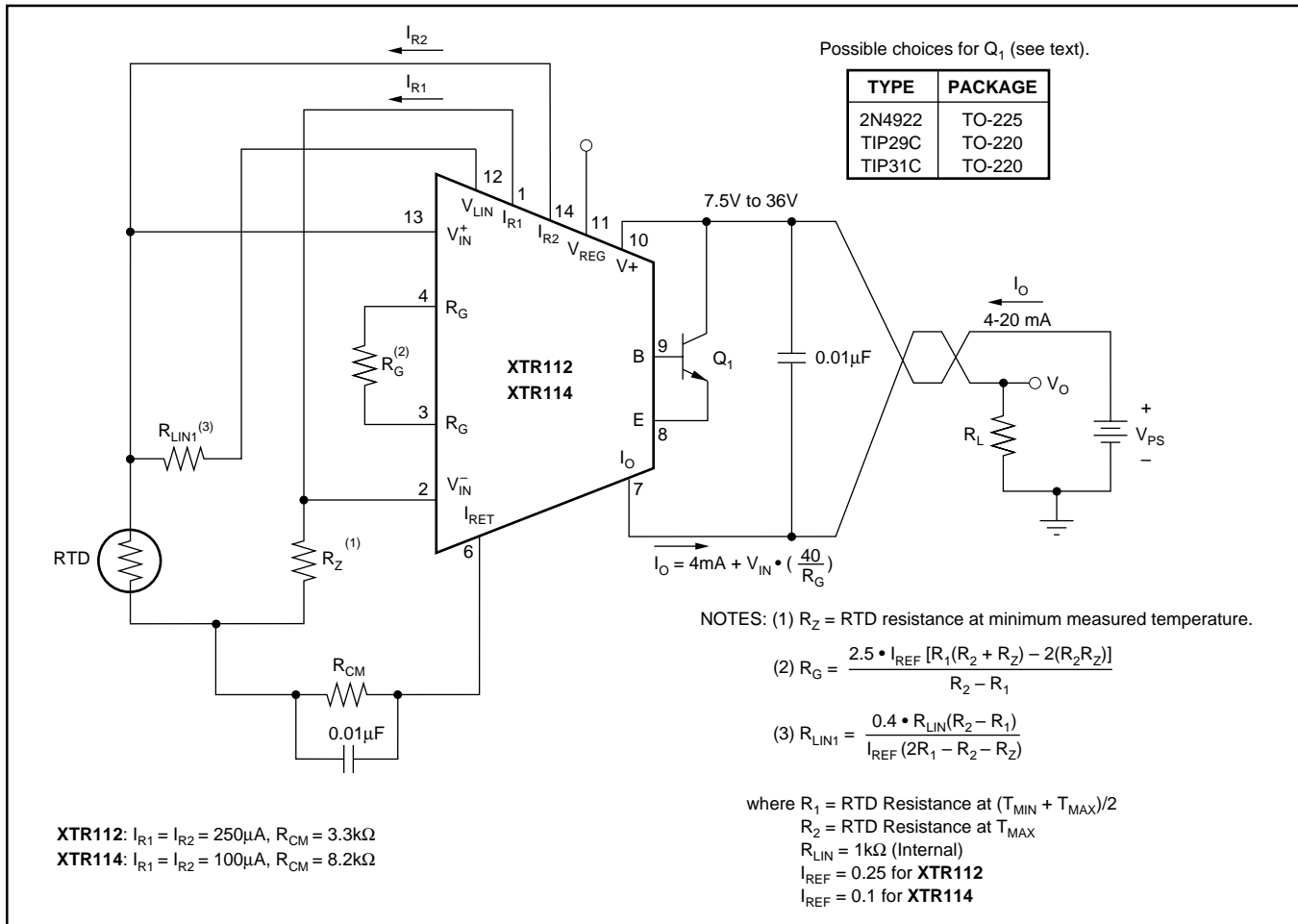

FIGURE 1. Basic Two-Wire RTD Temperature Measurement Circuit with Linearization.



A negative input voltage,  $V_{IN}$ , will cause the output current to be less than 4mA. Increasingly negative  $V_{IN}$  will cause the output current to limit at approximately 1.3mA for the XTR112 and 1mA for the XTR114. Refer to the typical curve “Under-Scale Current vs Temperature.”

Increasingly positive input voltage (greater than the full-scale input) will produce increasing output current according to the transfer function, up to the output current limit of approximately 27mA. Refer to the typical curve “Over-Scale Current vs Temperature.”

## EXTERNAL TRANSISTOR

Transistor  $Q_1$  conducts the majority of the signal-dependent 4-20mA loop current. Using an external transistor isolates the majority of the power dissipation from the precision input and reference circuitry of the XTR112 and XTR114, maintaining excellent accuracy.

Since the external transistor is inside a feedback loop its characteristics are not critical. Requirements are:  $V_{CEO} = 45V$  min,  $\beta = 40$  min and  $P_D = 800mW$ . Power dissipation requirements may be lower if the loop power supply voltage is less than 36V. Some possible choices for  $Q_1$  are listed in Figure 1.

The XTR112 and XTR114 can be operated without this external transistor, however, accuracy will be somewhat degraded due to the internal power dissipation. Operation without  $Q_1$  is not recommended for extended temperature ranges. A resistor ( $R = 3.3k\Omega$ ) connected between the  $I_{RET}$  pin and the E (emitter) pin may be needed for operation below  $0^\circ C$  without  $Q_1$  to guarantee the full 20mA full-scale output, especially with  $V+$  near 7.5V.

## LOOP POWER SUPPLY

The voltage applied to the XTR112 and XTR114,  $V+$ , is measured with respect to the  $I_O$  connection, pin 7.  $V+$  can

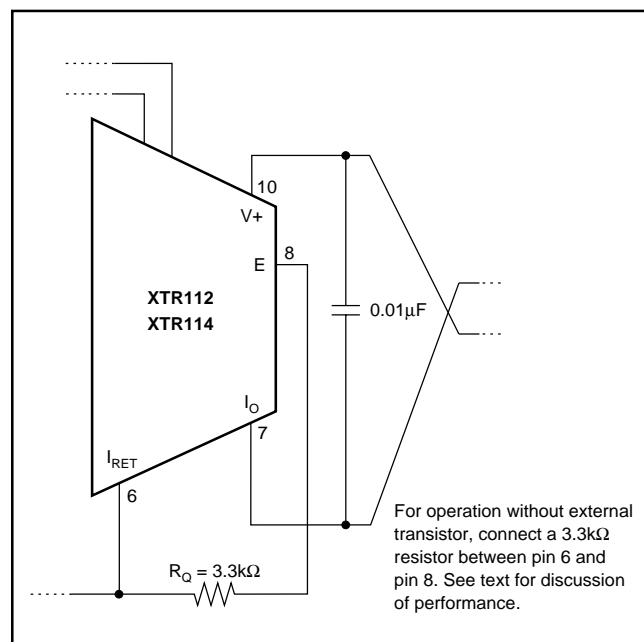

FIGURE 2. Operation Without External Transistor.

range from 7.5V to 36V. The loop supply voltage,  $V_{PS}$ , will differ from the applied voltage according to the voltage drop on the current sensing resistor,  $R_L$  (plus any other voltage drop in the line).

If a low loop supply voltage is used,  $R_L$  (including the loop wiring resistance) must be made a relatively low value to assure that  $V+$  remains 7.5V or greater for the maximum loop current of 20mA:

$$R_L \text{ max} = \left( \frac{(V+) - 7.5V}{20mA} \right) - R_{WIRING}$$

It is recommended to design for  $V+$  equal or greater than 7.5V with loop currents up to 30mA to allow for out-of-range input conditions.

The low operating voltage (7.5V) of the XTR112 and XTR114 allow operation directly from personal computer power supplies ( $12V \pm 5\%$ ). When used with the RCV420 Current Loop Receiver (Figure 7), load resistor voltage drop is limited to 3V.

## ADJUSTING INITIAL ERRORS

Many applications require adjustment of initial errors. Input offset and reference current mismatch errors can be corrected by adjustment of the zero resistor,  $R_Z$ . Adjusting the gain-setting resistor,  $R_G$ , corrects any errors associated with gain.

## TWO-WIRE AND THREE-WIRE RTD CONNECTIONS

In Figure 1, the RTD can be located remotely simply by extending the two connections to the RTD. With this remote two-wire connection to the RTD, line resistance will introduce error. This error can be partially corrected by adjusting the values of  $R_Z$ ,  $R_G$ , and  $R_{LIN1}$ .

A better method for remotely located RTDs is the three-wire RTD connection shown in Figure 3. This circuit offers improved accuracy.  $R_Z$ 's current is routed through a third wire to the RTD. Assuming line resistance is equal in RTD lines 1 and 2, this produces a small common-mode voltage which is rejected by the XTR112 and XTR114. A second resistor,  $R_{LIN2}$ , is required for linearization.

Note that although the two-wire and three-wire RTD connection circuits are very similar, the gain-setting resistor,  $R_G$ , has slightly different equations:

$$\text{Two-wire: } R_G = \frac{2.5 \cdot I_{REF} [R_1(R_2 + R_Z) - 2(R_2 R_Z)]}{R_2 - R_1}$$

$$\text{Three-wire: } R_G = \frac{2.5 \cdot I_{REF} (R_2 - R_Z)(R_1 - R_Z)}{R_2 - R_1}$$

where  $R_Z =$  RTD resistance at  $T_{MIN}$   
 $R_1 =$  RTD resistance at  $(T_{MIN} + T_{MAX})/2$   
 $R_2 =$  RTD resistance at  $T_{MAX}$   
 $I_{REF} = 0.25$  for XTR112  
 $I_{REF} = 0.1$  for XTR114

Table I summarizes the resistor equations for two-wire and three-wire RTD connections. An example calculation is also provided. To maintain good accuracy, at least 1% (or better) resistors should be used for  $R_G$ . Table II provides standard 1%  $R_G$  values for a three-wire Pt1000 RTD connection with linearization for the XTR112. Table III gives  $R_G$  values for the XTR114.

## LINEARIZATION

RTD temperature sensors are inherently (but predictably) nonlinear. With the addition of one or two external resistors,  $R_{LIN1}$  and  $R_{LIN2}$ , it is possible to compensate for most of this nonlinearity resulting in 40:1 improvement in linearity over the uncompensated output.

	TWO-WIRE		THREE-WIRE		
	$R_G$	$R_{LIN1}$	$R_G$	$R_{LIN1}$	$R_{LIN2}$
General Equations	$= \frac{I_{REF} \cdot 2.5 [R_1 (R_2 + R_Z) - 2 (R_2 R_Z)]}{(R_2 - R_1)}$	$= \frac{0.4 \cdot R_{LIN} (R_2 - R_1)}{I_{REF} \cdot (2R_1 - R_2 - R_Z)}$	$= \frac{I_{REF} \cdot 2.5 (R_2 - R_Z) (R_1 - R_Z)}{(R_2 - R_1)}$	$= \frac{0.4 \cdot R_{LIN} (R_2 - R_1)}{I_{REF} \cdot (2R_1 - R_2 - R_Z)}$	$= \frac{0.4 \cdot (R_{LIN} + R_G)(R_2 - R_1)}{I_{REF} \cdot (2R_1 - R_2 - R_Z)}$
XTR112 ( $I_{REF} = 0.25$ ) (see Table II)	$= \frac{0.625 \cdot [R_1 (R_2 + R_Z) - 2 (R_2 R_Z)]}{(R_2 - R_1)}$	$= \frac{1.6 \cdot R_{LIN} (R_2 - R_1)}{(2R_1 - R_2 - R_Z)}$	$= \frac{0.625 \cdot (R_2 - R_Z) (R_1 - R_Z)}{(R_2 - R_1)}$	$= \frac{1.6 \cdot R_{LIN} (R_2 - R_1)}{(2R_1 - R_2 - R_Z)}$	$= \frac{1.6 \cdot (R_{LIN} + R_G)(R_2 - R_1)}{(2R_1 - R_2 - R_Z)}$
XTR114 ( $I_{REF} = 0.1$ ) (see Table III)	$= \frac{0.25 \cdot [R_1 (R_2 + R_Z) - 2 (R_2 R_Z)]}{(R_2 - R_1)}$	$= \frac{4 \cdot R_{LIN} (R_2 - R_1)}{(2R_1 - R_2 - R_Z)}$	$= \frac{0.25 \cdot (R_2 - R_Z) (R_1 - R_Z)}{(R_2 - R_1)}$	$= \frac{4 \cdot R_{LIN} (R_2 - R_1)}{(2R_1 - R_2 - R_Z)}$	$= \frac{4 \cdot (R_{LIN} + R_G)(R_2 - R_1)}{(2R_1 - R_2 - R_Z)}$

where  $R_Z$  = RTD resistance at the minimum measured temperature,  $T_{MIN}$

$R_1$  = RTD resistance at the midpoint measured temperature,  $T_{MID} = (T_{MIN} + T_{MAX})/2$

$R_2$  = RTD resistance at maximum measured temperature,  $T_{MAX}$

$R_{LIN} = 1k\Omega$  (internal)

### XTR112 RESISTOR EXAMPLE:

The measurement range is  $-100^\circ\text{C}$  to  $+200^\circ\text{C}$  for a 3-wire Pt100 RTD connection. Determine the values for  $R_S$ ,  $R_G$ ,  $R_{LIN1}$ , and  $R_{LIN2}$ . Look up the values from the chart or calculate the values according to the equations provided.

#### METHOD 1: TABLE LOOK UP

$T_{MIN} = -100^\circ\text{C}$  and  $\Delta T = 300^\circ\text{C}$  ( $T_{MAX} = +200^\circ\text{C}$ ),

Using Table II the 1% values are:

$$R_Z = 604\Omega \quad R_{LIN1} = 33.2k\Omega$$

$$R_G = 750\Omega \quad R_{LIN2} = 59k\Omega$$

#### METHOD 2: CALCULATION

**Step 1:** Determine  $R_Z$ ,  $R_1$ , and  $R_2$ .

$R_Z$  is the RTD resistance at the minimum measured temperature,  $T_{MIN} = -100^\circ\text{C}$ . Using Equation (1) at right gives  $R_Z = 602.5\Omega$  (1% value is 604 $\Omega$ ).

$R_2$  is the RTD resistance at the maximum measured temperature,  $T_{MAX} = 200^\circ\text{C}$ . Using Equation (2) at right gives  $R_2 = 1758.4\Omega$ .

$R_1$  is the RTD resistance at the midpoint measured temperature,  $T_{MID} = (T_{MIN} + T_{MAX})/2 = (-100 + 200)/2 = 50^\circ\text{C}$ .  $R_1$  is NOT the average of  $R_Z$  and  $R_2$ . Using Equation (2) at right gives  $R_1 = 1194\Omega$ .

**Step 2:** Calculate  $R_G$ ,  $R_{LIN1}$ , and  $R_{LIN2}$  using equations above.

$$R_G = 757\Omega \text{ (1% value is } 750\Omega\text{)}$$

$$R_{LIN1} = 33.322k\Omega \text{ (1% value is } 33.2k\Omega\text{)}$$

$$R_{LIN2} = 58.548k\Omega \text{ (1% value is } 59k\Omega\text{)}$$

#### Calculation of Pt1000 Resistance Values

(according to DIN IEC 751)

Equation (1) Temperature range from  $-200^\circ\text{C}$  to  $0^\circ\text{C}$ :

$$R_{(T)} = 1000 [1 + 3.90802 \cdot 10^{-3} \cdot T - 0.5802 \cdot 10^{-6} \cdot T^2 - 4.27350 \cdot 10^{-12} \cdot (T - 100) \cdot T^3]$$

Equation (2) Temperature range from  $0^\circ\text{C}$  to  $+850^\circ\text{C}$ :

$$R_{(T)} = 1000 (1 + 3.90802 \cdot 10^{-3} \cdot T - 0.5802 \cdot 10^{-6} \cdot T^2)$$

where:  $R_{(T)}$  is the resistance in  $\Omega$  at temperature  $T$ .  
 $T$  is the temperature in  $^\circ\text{C}$ .

NOTE: Most RTD manufacturers provide reference tables for resistance values at various temperatures.

**Resistor values for other RTD types (such as Pt2000) can be calculated using the XTR resistor selection program in the Applications Section on Burr-Brown's web site ([www.burr-brown.com](http://www.burr-brown.com))**

TABLE I. Summary of Resistor Equations for Two-Wire and Three-Wire Pt1000 RTD Connections.

**XTR112 1% RESISTOR VALUES FOR A THREE-WIRE RTD CONNECTION**

**MEASUREMENT TEMPERATURE SPAN ΔT (°C)**

T <sub>MIN</sub>	100°C	200°C	300°C	400°C	500°C	600°C	700°C	800°C	900°C	1000°C
-200°C	187/267 48700 61900	187/536 31600 48700	187/806 25500 46400	187/1050 21500 44200	187/1330 17800 41200	187/1580 15000 39200	187/1820 13000 36500	187/2100 11300 34800	187/2370 9760 33200	187/2670 8660 31600
-100°C	604/255 86600 110000	604/499 49900 75000	604/4750 33200 59000	604/1000 24900 49900	604/1270 19600 44200	604/1500 15800 40200	604/1780 13300 37400	604/2050 11500 34800	604/2260 10000 32400	
0°C	1000/243 105000 130000	1000/487 51100 76800	1000/732 33200 57600	1000/976 24300 48700	1000/1210 19100 42200	1000/1470 15400 38300	1000/1740 13000 35700	1000/1960 11000 33200		
100°C	1370/237 102000 127000	1370/475 49900 73200	1370/715 32400 56200	1370/953 23700 46400	1370/1180 18700 40200	1370/1430 15000 36500	1370/1690 12400 33200			
200°C	1740/232 100000 121000	1740/464 48700 69800	1740/698 31600 53600	1740/931 23200 44200	1740/1150 17800 38300	1740/1400				
300°C	2100/221 95300 118000	2100/442 46400 68100	2100/665 30100 51100	2100/887 22100 42200	2100/1130 17400 36500					
400°C	2490/215 93100 113000	2490/432 45300 64900	2490/649 29400 48700	2490/866 21500 40200						
500°C	2800/210 887000 107000	2800/412 43200 61900	2800/619 28000 45300							
600°C	3160/200 86600 102000	3160/402 42200 59000								
700°C	3480/191 82500 100000									
800°C	3740/187 80600 95300									

$$\begin{bmatrix} R_Z/R_G \\ R_{LIN1} \\ R_{LIN2} \end{bmatrix}$$

NOTE: The values listed in the table are 1% resistors (in Ω). Exact values may be calculated from the following equations:

$R_Z$  = RTD resistance at minimum measured temperature, T<sub>MIN</sub>.

$$R_G = \frac{0.625 \cdot (R_2 - R_Z) (R_1 - R_Z)}{(R_2 - R_1)}$$

$$R_{LIN1} = \frac{1.6 \cdot R_{LIN} (R_2 - R_1)}{(2R_1 - R_2 - R_Z)}$$

$$R_{LIN2} = \frac{1.6 \cdot (R_{LIN} + R_G) (R_2 - R_1)}{(2R_1 - R_2 - R_Z)}$$

where R<sub>1</sub> = RTD resistance at the midpoint measured temperature, (T<sub>MIN</sub> + T<sub>MAX</sub>)/2  
R<sub>2</sub> = RTD resistance at T<sub>MAX</sub>  
R<sub>LIN</sub> = 1kΩ (Internal)

TABLE II. XTR112 R<sub>Z</sub>, R<sub>G</sub>, R<sub>LIN1</sub>, and R<sub>LIN2</sub> Standard 1% Resistor Values for Three-Wire Pt1000 RTD Connection with Linearization.

**XTR114 1% RESISTOR VALUES FOR A THREE-WIRE RTD CONNECTION**

**MEASUREMENT TEMPERATURE SPAN ΔT (°C)**

T <sub>MIN</sub>	100°C	200°C	300°C	400°C	500°C	600°C	700°C	800°C	900°C	1000°C
-200°C	187/107 121000 133000	187/215 78700 95300	187/316 64900 84500	187/422 53600 76800	187/523 45300 68100	187/634 38300 68100	187/732 32400 56200	187/845 28000 52300	187/953 24900 47500	187/1050 21500 45300
-100°C	604/102 221000 243000	604/200 124000 150000	604/301 84500 110000	604/402 61900 86600	604/511 48700 73200	604/604 40200 63400	604/715 33200 57600	604/806 28700 52300	604/909 24900 47500	
0°C	1000/97.6 261000 287000	1000/196 130000 154000	1000/294 84500 107000	1000/392 61900 84500	1000/487 47500 71500	1000/590 39200 61900	1000/681 32400 54900	1000/787 27400 49900		
100°C	1370/95.3 255000 280000	1370/191 124000 147000	1370/287 80600 105000	1370/383 59000 82500	1370/475 46400 68100	1370/576 37400 59000	1370/665 31600 52300			
200°C	1740/90.9 249000 267000	1740/182 121000 143000	1740/274 78700 100000	1740/365 57600 78700	1740/464 44200 64900	1740/549 36500 56200				
300°C	2100/88.9 237000 261000	2100/178 118000 137000	2100/267 75000 95300	2100/357 54900 75000	2100/348 43200 61900					
400°C	2490/86.6 232000 249000	2490/174 113000 133000	2490/261 73200 93100	2490/249 53600 71500						
500°C	2800/82.5 221000 243000	2800/165 110000 127000	2800/49 69800 88700							
600°C	3160/80.6 215000 215000	3160/162 105000 121000								
700°C	3480/76.8 205000 221000									
800°C	3740/75 200000 215000									

$$\begin{bmatrix} R_Z/R_G \\ R_{LIN1} \\ R_{LIN2} \end{bmatrix}$$

NOTE: The values listed in the table are 1% resistors (in Ω). Exact values may be calculated from the following equations:

$R_Z$  = RTD resistance at minimum measured temperature, T<sub>MIN</sub>.

$$R_G = \frac{0.25 \cdot (R_2 - R_Z) (R_1 - R_Z)}{(R_2 - R_1)}$$

$$R_{LIN1} = \frac{4 \cdot R_{LIN} (R_2 - R_1)}{(2R_1 - R_2 - R_Z)}$$

$$R_{LIN2} = \frac{4 \cdot (R_{LIN} + R_G) (R_2 - R_1)}{(2R_1 - R_2 - R_Z)}$$

where R<sub>1</sub> = RTD resistance at the midpoint measured temperature, (T<sub>MIN</sub> + T<sub>MAX</sub>)/2  
R<sub>2</sub> = RTD resistance at T<sub>MAX</sub>  
R<sub>LIN</sub> = 1kΩ (Internal)

TABLE III. XTR114 R<sub>Z</sub>, R<sub>G</sub>, R<sub>LIN1</sub>, and R<sub>LIN2</sub> Standard 1% Resistor Values for Three-Wire Pt1000 RTD Connection with Linearization.

A typical two-wire RTD application with linearization is shown in Figure 1. Resistor  $R_{LIN1}$  provides positive feedback and controls linearity correction.  $R_{LIN1}$  is chosen according to the desired temperature range. An equation is given in Figure 1.

In three-wire RTD connections, an additional resistor,  $R_{LIN2}$ , is required. As with the two-wire RTD application,  $R_{LIN1}$  provides positive feedback for linearization.  $R_{LIN2}$  provides an offset canceling current to compensate for wiring resistance encountered in remotely located RTDs.  $R_{LIN1}$  and  $R_{LIN2}$  are chosen such that their currents are equal. This makes the voltage drop in the wiring resistance to the RTD a common-mode signal which is rejected by the XTR112 and XTR114. The nearest standard 1% resistor values for  $R_{LIN1}$  and  $R_{LIN2}$  should be adequate for most applications. Tables II and III provide the 1% resistor values for a three-wire Pt1000 RTD connection.

If no linearity correction is desired, the  $V_{LIN}$  pin should be left open. With no linearization,  $R_G = 2500 \cdot V_{FS}$ , where  $V_{FS}$  = full-scale input range.

### RTDs

The text and figures thus far have assumed a Pt1000 RTD. With higher resistance RTDs, the temperature range and input voltage variation should be evaluated to ensure proper common-mode biasing of the inputs. As mentioned earlier,

$R_{CM}$  can be adjusted to provide an additional voltage drop to bias the inputs of the XTR112 and XTR114 within their common-mode input range.

### ERROR ANALYSIS

Table IV shows how to calculate the effect various error sources have on circuit accuracy. A sample error calculation for a typical RTD measurement circuit (Pt1000 RTD, 200°C measurement span) is provided. The results reveal the XTR112's and XTR114's excellent accuracy, in this case 1% unadjusted for the XTR112, 1.16% for the XTR114. Adjusting resistors  $R_G$  and  $R_Z$  for gain and offset errors improves the XTR112's accuracy to 0.28% (0.31% for the XTR114). Note that these are worst-case errors; guaranteed maximum values were used in the calculations and all errors were assumed to be positive (additive). The XTR112 and XTR114 achieve performance which is difficult to obtain with discrete circuitry and requires less space.

### OPEN-CIRCUIT PROTECTION

The optional transistor  $Q_2$  in Figure 3 provides predictable behavior with open-circuit RTD connections. It assures that if any one of the three RTD connections is broken, the XTR's output current will go to either its high current limit ( $\approx 27\text{mA}$ ) or low current limit ( $\approx 1.3\text{mA}$  for XTR112 and  $\approx 1\text{mA}$  for XTR114). This is easily detected as an out-of-range condition.

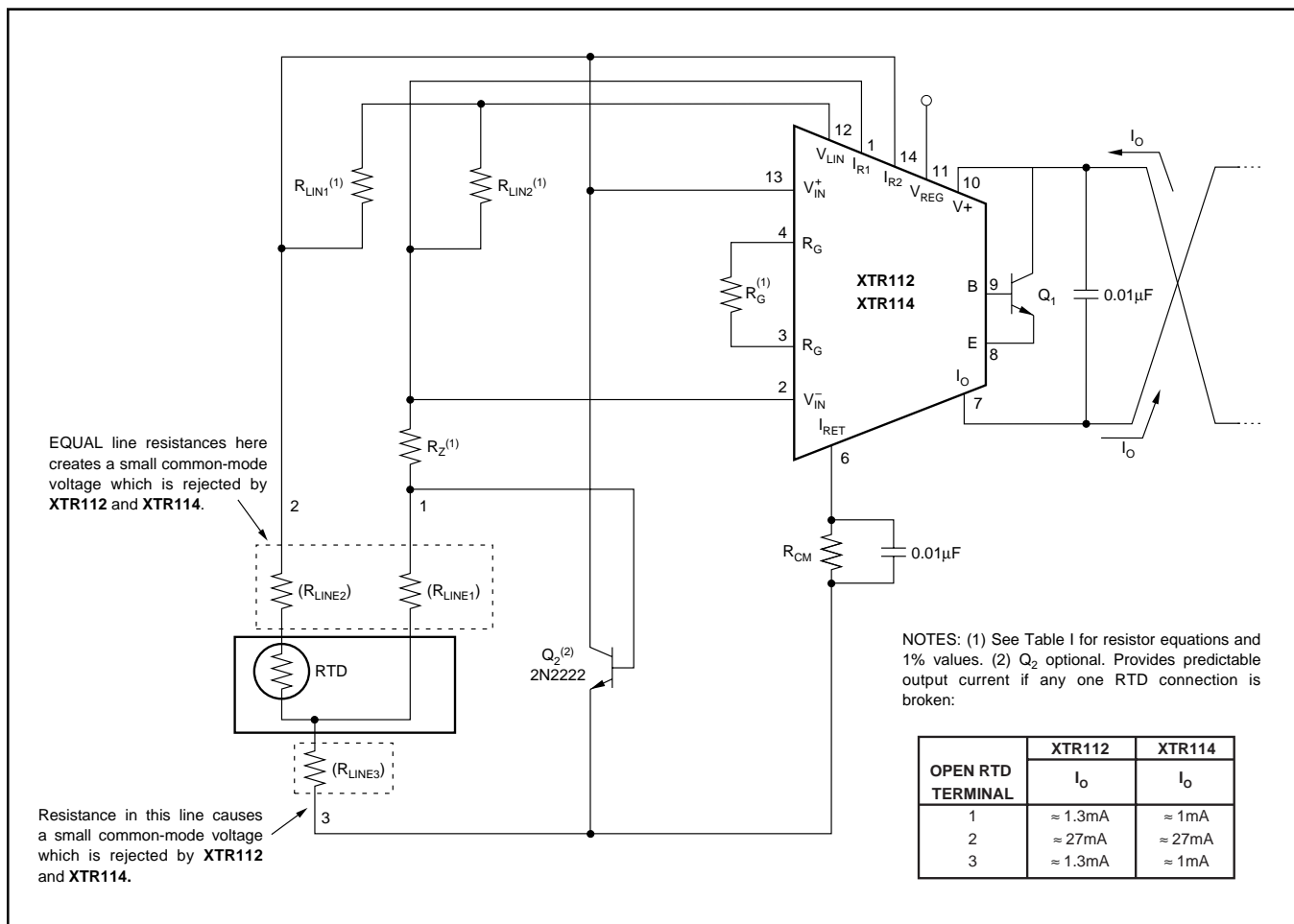

FIGURE 3. Three-Wire Connection for Remotely Located RTDs.

### SAMPLE ERROR CALCULATION FOR XTR112<sup>(1)</sup>

RTD value at 4mA Output ( $R_{RTD\ MIN}$ )	1000 $\Omega$
RTD Measurement Range	200 $^{\circ}$ C
Ambient Temperature Range ( $\Delta T_A$ )	20 $^{\circ}$ C
Supply Voltage Change ( $\Delta V+$ )	5V
Common-Mode Voltage Change ( $\Delta CM$ )	0.1V

ERROR SOURCE	ERROR EQUATION	SAMPLE ERROR CALCULATION <sup>(2)</sup>	ERROR (ppm of Full Scale)	
			UNADJ.	ADJUST.
<b>INPUT</b>				
Input Offset Voltage vs Common-Mode	$V_{OS}/(V_{IN\ MAX}) \cdot 10^6$	$100\mu V/(250\mu A \cdot 3.8\Omega/^{\circ}C \cdot 200^{\circ}C) \cdot 10^6$	526	0
Input Bias Current	$CMRR \cdot \Delta CM/(V_{IN\ MAX}) \cdot 10^6$	$50\mu V/V \cdot 0.1V/(250\mu A \cdot 3.8\Omega/^{\circ}C \cdot 200^{\circ}C) \cdot 10^6$	26	26
Input Offset Current	$I_b/I_{REF} \cdot 10^6$	$0.025\mu A/250\mu A \cdot 10^6$	100	0
	$I_{OS} \cdot R_{RTD\ MIN}/(V_{IN\ MAX}) \cdot 10^6$	$3nA \cdot 1000\Omega/(250\mu A \cdot 3.8\Omega/^{\circ}C \cdot 200^{\circ}C) \cdot 10^6$	16	0
		<b>Total Input Error:</b>	<b>668</b>	<b>26</b>
<b>EXCITATION</b>				
Current Reference Accuracy vs Supply	$I_{REF\ Accuracy} (\%)/100\% \cdot 10^6$	$0.2\%/100\% \cdot 10^6$	2000	0
Current Reference Matching vs Supply	$(I_{REF\ VS\ V+}) \cdot \Delta V+$ $I_{REF\ Matching} (\%)/100\% \cdot I_{REF} \cdot R_{RTD\ MIN}/(V_{IN\ MAX}) \cdot 10^6$ $(I_{REF\ matching\ vs\ V+}) \cdot \Delta V+ \cdot R_{RTD\ MIN}/(V_{IN\ MAX})$	$25ppm/V \cdot 5V$ $0.1\%/100\% \cdot 250\mu A \cdot 1000\Omega/(250\mu A \cdot 3.8\Omega/^{\circ}C \cdot 200^{\circ}C) \cdot 10^6$ $10ppm/V \cdot 5V \cdot 250\mu A \cdot 1000\Omega/(250\mu A \cdot 3.8\Omega/^{\circ}C \cdot 200^{\circ}C)$	125 1316 66	125 0 66
		<b>Total Excitation Error:</b>	<b>3507</b>	<b>191</b>
<b>GAIN</b>				
Span	$Span\ Error (\%)/100\% \cdot 10^6$	$0.2\%/100\% \cdot 10^6$	2000	0
Nonlinearity	$Nonlinearity (\%)/100\% \cdot 10^6$	$0.01\%/100\% \cdot 10^6$	100	100
		<b>Total Gain Error:</b>	<b>2100</b>	<b>100</b>
<b>OUTPUT</b>				
Zero Output vs Supply	$(I_{ZERO} - 4mA)/16000\mu A \cdot 10^6$ $(I_{ZERO\ VS\ V+}) \cdot \Delta V+/16000\mu A \cdot 10^6$	$25\mu A/16000\mu A \cdot 10^6$ $0.2\mu A/V \cdot 5V/16000\mu A \cdot 10^6$	1563 63	0 63
		<b>Total Output Error:</b>	<b>1626</b>	<b>63</b>
<b>DRIFT (<math>\Delta T_A = 20^{\circ}C</math>)</b>				
Input Offset Voltage	$Drift \cdot \Delta T_A/(V_{IN\ MAX}) \cdot 10^6$	$1.5\mu V/^{\circ}C \cdot 20^{\circ}C/(250\mu A \cdot 3.8\Omega/^{\circ}C \cdot 200^{\circ}C) \cdot 10^6$	158	158
Input Bias Current (typical)	$Drift \cdot \Delta T_A/I_{REF} \cdot 10^6$	$20pA/^{\circ}C \cdot 20^{\circ}C/250\mu A \cdot 10^6$	2	2
Input Offset Current (typical)	$Drift \cdot \Delta T_A \cdot R_{RTD\ MIN}/(V_{IN\ MAX}) \cdot 10^6$	$5pA/^{\circ}C \cdot 20^{\circ}C \cdot 1000\Omega/(250\mu A \cdot 3.8\Omega/^{\circ}C \cdot 200^{\circ}C) \cdot 10^6$	0.5	0.5
Current Reference Accuracy	$Drift \cdot \Delta T_A$	$35ppm/^{\circ}C \cdot 20^{\circ}C$	700	700
Current Reference Matching	$Drift \cdot \Delta T_A \cdot I_{REF} \cdot R_{RTD\ MIN}/(V_{IN\ MAX})$	$15ppm/^{\circ}C \cdot 20^{\circ}C \cdot 250\mu A \cdot 1000\Omega/(250\mu A \cdot 3.8\Omega/^{\circ}C \cdot 200^{\circ}C)$	395	395
Span	$Drift \cdot \Delta T_A$	$25ppm/^{\circ}C \cdot 20^{\circ}C$	500	500
Zero Output	$Drift \cdot \Delta T_A/16000\mu A \cdot 10^6$	$0.5\mu A/^{\circ}C \cdot 20^{\circ}C/16000\mu A \cdot 10^6$	626	626
		<b>Total Drift Error:</b>	<b>2382</b>	<b>2382</b>
<b>NOISE (0.1Hz to 10Hz, typ)</b>				
Input Offset Voltage	$V_n/(V_{IN\ MAX}) \cdot 10^6$	$0.6\mu V/(250\mu A \cdot 3.8\Omega/^{\circ}C \cdot 200^{\circ}C) \cdot 10^6$	3	3
Current Reference	$I_{REF\ Noise} \cdot R_{RTD\ MIN}/(V_{IN\ MAX}) \cdot 10^6$	$3nA \cdot 1000\Omega/(250\mu A \cdot 3.8\Omega/^{\circ}C \cdot 200^{\circ}C) \cdot 10^6$	16	16
Zero Output	$I_{ZERO\ Noise}/16000\mu A \cdot 10^6$	$0.03\mu A/16000\mu A \cdot 10^6$	2	2
		<b>Total Noise Error:</b>	<b>21</b>	<b>21</b>
		<b>TOTAL ERROR:</b>	<b>10304</b>	<b>2783</b>
			<b>(1.03%)</b>	<b>(0.28%)</b>

NOTES: (1) For XTR114,  $I_{REF} = 100\mu A$ . Total unadjusted error is 1.16%, adjusted error 0.31%. (2) All errors are min/max and referred to input, unless otherwise stated.

TABLE IV. Error Calculation.

### REVERSE-VOLTAGE PROTECTION

The XTR112's and XTR114's low compliance rating (7.5V) permits the use of various voltage protection methods without compromising operating range. Figure 4 shows a diode bridge circuit which allows normal operation even when the voltage connection lines are reversed. The bridge causes a two diode drop (approximately 1.4V) loss in loop supply voltage. This results in a compliance voltage of approximately 9V—satisfactory for most applications. If 1.4V drop in loop supply is too much, a diode can be inserted in series with the loop supply voltage and the V+ pin. This protects against reverse output connection lines with only a 0.7V loss in loop supply voltage.

### SURGE PROTECTION

Remote connections to current transmitters can sometimes be subjected to voltage surges. It is prudent to limit the maximum surge voltage applied to the XTR to as low as practical. Various zener diode and surge clamping diodes are specially designed for this purpose. Select a clamp diode with as low a voltage rating as possible for best protection. For example, a 36V protection diode will assure proper transmitter operation at normal loop voltages, yet will provide an appropriate level of protection against voltage surges. Characterization tests on three production lots showed no damage to the XTR112 or XTR114 within loop supply voltages up to 65V.

Most surge protection zener diodes have a diode characteristic in the forward direction that will conduct excessive current, possibly damaging receiving-side circuitry if the loop connections are reversed. If a surge protection diode is used, a series diode or diode bridge should be used for protection against reversed connections.

### RADIO FREQUENCY INTERFERENCE

The long wire lengths of current loops invite radio frequency interference. RF can be rectified by the sensitive input circuitry of the XTR112 and XTR114 causing errors. This generally appears as an unstable output current that varies with the position of loop supply or input wiring.

If the RTD sensor is remotely located, the interference may enter at the input terminals. For integrated transmitter assemblies with short connection to the sensor, the interference more likely comes from the current loop connections.

Bypass capacitors on the input reduce or eliminate this input interference. Connect these bypass capacitors to the  $I_{RET}$  terminal as shown in Figure 5. Although the dc voltage at the  $I_{RET}$  terminal is not equal to 0V (at the loop supply,  $V_{PS}$ ) this circuit point can be considered the transmitter's "ground." The  $0.01\mu\text{F}$  capacitor connected between  $V+$  and  $I_O$  may help minimize output interference.

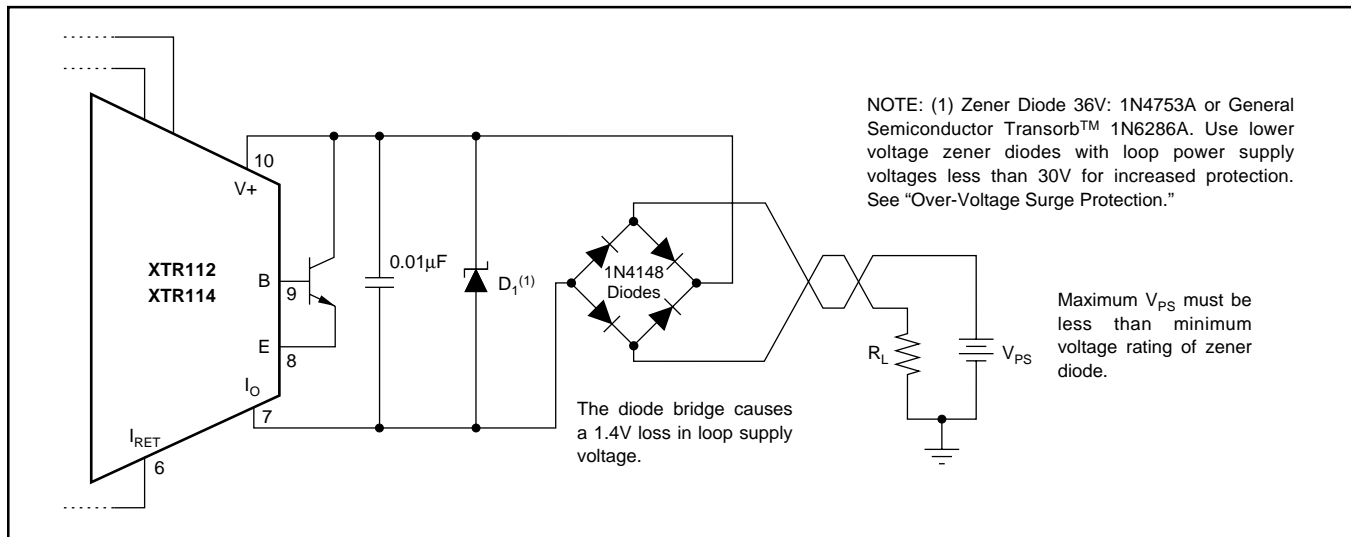

FIGURE 4. Reverse Voltage Operation and Over-Voltage Surge Protection.

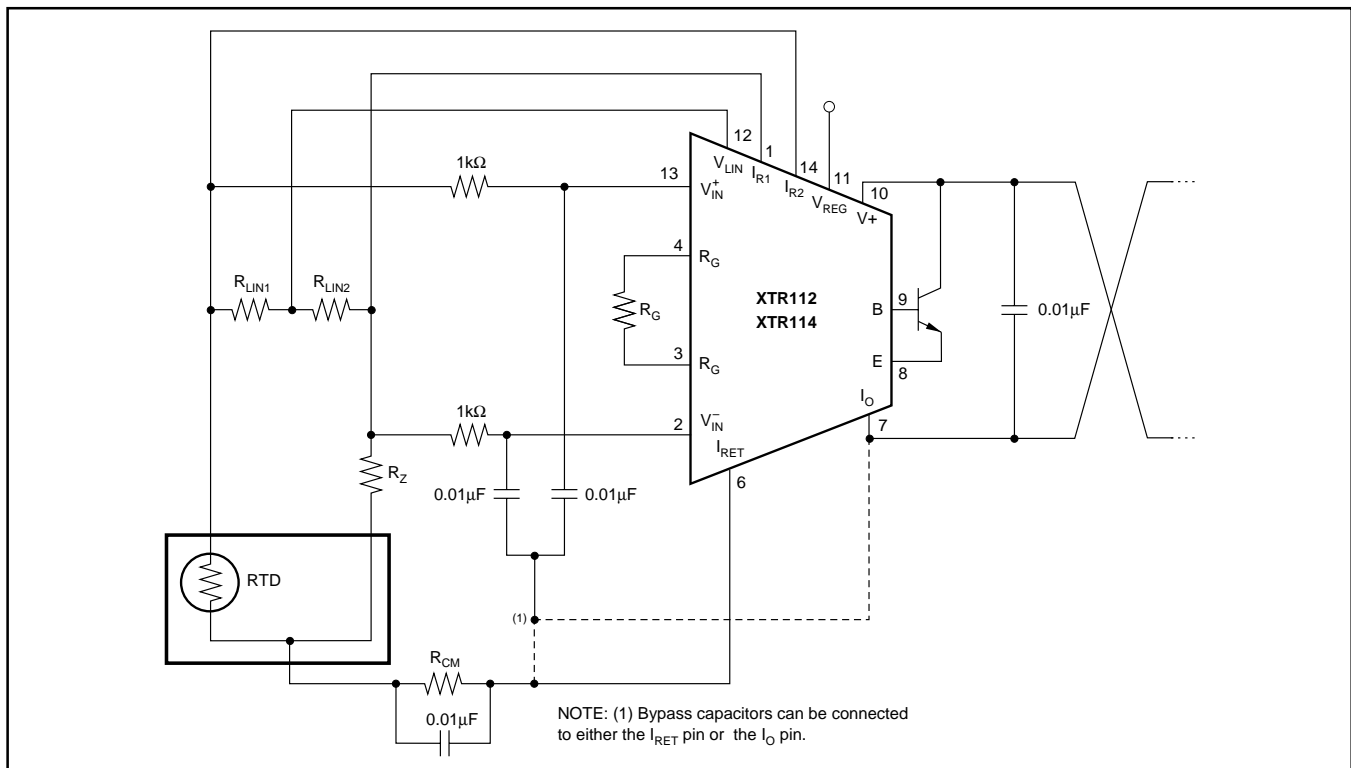

FIGURE 5. Input Bypassing Technique with Linearization.

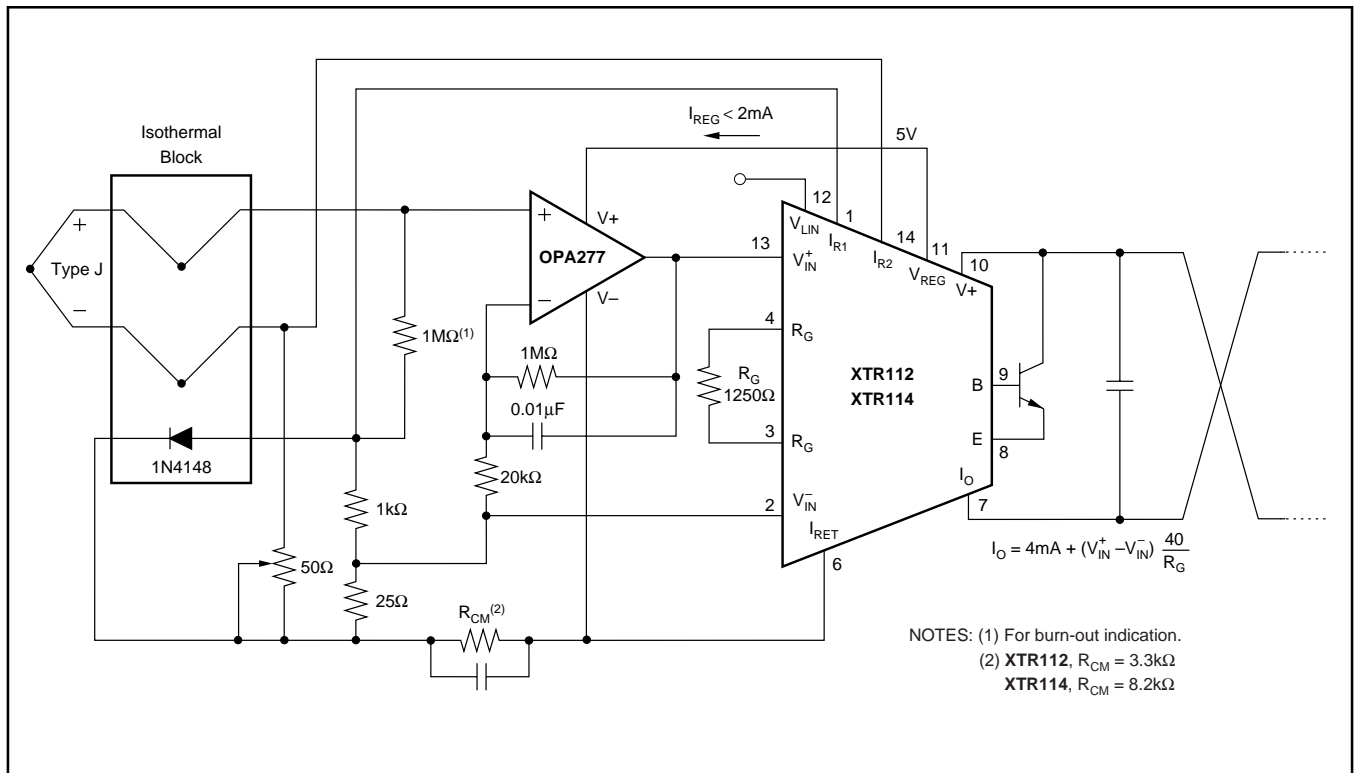

FIGURE 6. Thermocouple Low Offset, Low Drift Loop Measurement with Diode Cold-Junction Compensation.

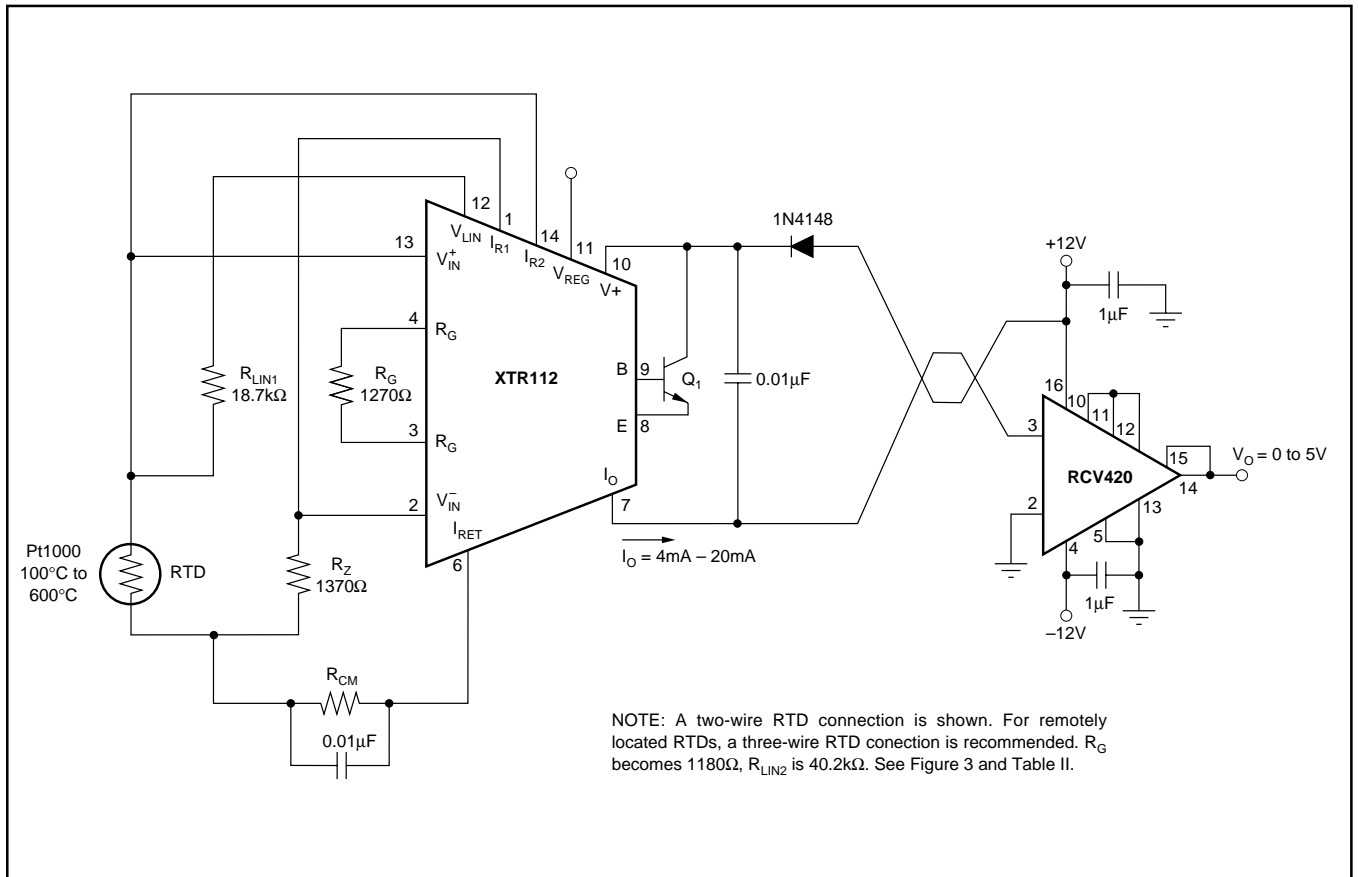

FIGURE 7. ±12V Powered Transmitter/Receiver Loop.

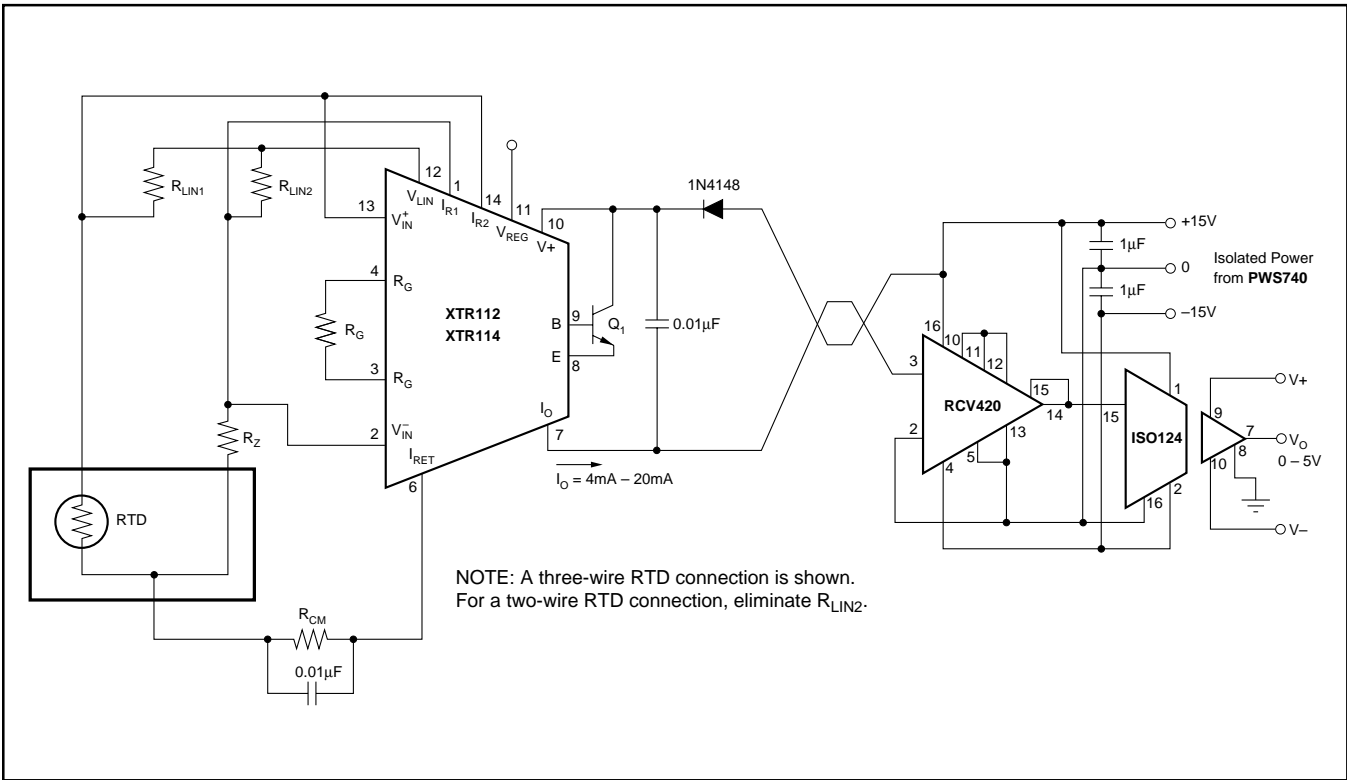

FIGURE 8. Isolated Transmitter/Receiver Loop.

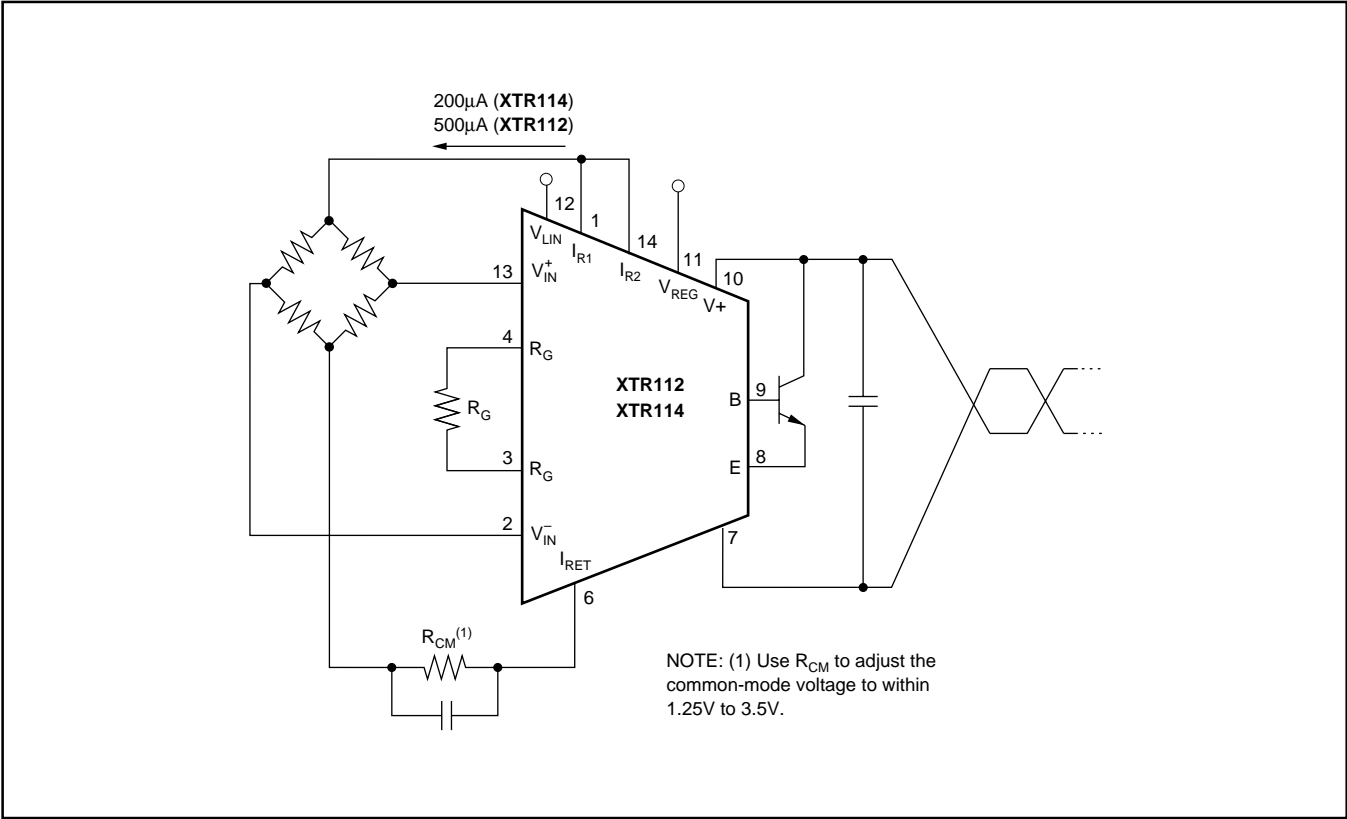

FIGURE 9. Bridge Input, Current Excitation.



**PACKAGING INFORMATION**

Orderable Device	Status <sup>(1)</sup>	Package Type	Package Drawing	Pins	Package Qty	Eco Plan <sup>(2)</sup>	Lead/Ball Finish	MSL Peak Temp <sup>(3)</sup>
XTR112U	ACTIVE	SOIC	D	14	58	None	CU SNPB	Level-3-220C-168 HR
XTR112U/2K5	ACTIVE	SOIC	D	14	2500	None	CU SNPB	Level-3-220C-168 HR
XTR112UA	ACTIVE	SOIC	D	14	58	None	CU SNPB	Level-3-220C-168 HR
XTR112UA/2K5	ACTIVE	SOIC	D	14	2500	None	CU SNPB	Level-3-220C-168 HR
XTR114U	ACTIVE	SOIC	D	14	58	None	CU SNPB	Level-3-220C-168 HR
XTR114U/2K5	ACTIVE	SOIC	D	14	2500	None	CU SNPB	Level-3-220C-168 HR
XTR114UA	ACTIVE	SOIC	D	14	58	None	CU SNPB	Level-3-220C-168 HR
XTR114UA/2K5	ACTIVE	SOIC	D	14	2500	None	CU SNPB	Level-3-220C-168 HR

<sup>(1)</sup> The marketing status values are defined as follows:

**ACTIVE:** Product device recommended for new designs.

**LIFEBUY:** TI has announced that the device will be discontinued, and a lifetime-buy period is in effect.

**NRND:** Not recommended for new designs. Device is in production to support existing customers, but TI does not recommend using this part in a new design.

**PREVIEW:** Device has been announced but is not in production. Samples may or may not be available.

**OBSOLETE:** TI has discontinued the production of the device.

<sup>(2)</sup> Eco Plan - May not be currently available - please check <http://www.ti.com/productcontent> for the latest availability information and additional product content details.

**None:** Not yet available Lead (Pb-Free).

**Pb-Free (RoHS):** TI's terms "Lead-Free" or "Pb-Free" mean semiconductor products that are compatible with the current RoHS requirements for all 6 substances, including the requirement that lead not exceed 0.1% by weight in homogeneous materials. Where designed to be soldered at high temperatures, TI Pb-Free products are suitable for use in specified lead-free processes.

**Green (RoHS & no Sb/Br):** TI defines "Green" to mean "Pb-Free" and in addition, uses package materials that do not contain halogens, including bromine (Br) or antimony (Sb) above 0.1% of total product weight.

<sup>(3)</sup> MSL, Peak Temp. -- The Moisture Sensitivity Level rating according to the JEDEC industry standard classifications, and peak solder temperature.

**Important Information and Disclaimer:** The information provided on this page represents TI's knowledge and belief as of the date that it is provided. TI bases its knowledge and belief on information provided by third parties, and makes no representation or warranty as to the accuracy of such information. Efforts are underway to better integrate information from third parties. TI has taken and continues to take reasonable steps to provide representative and accurate information but may not have conducted destructive testing or chemical analysis on incoming materials and chemicals. TI and TI suppliers consider certain information to be proprietary, and thus CAS numbers and other limited information may not be available for release.

In no event shall TI's liability arising out of such information exceed the total purchase price of the TI part(s) at issue in this document sold by TI to Customer on an annual basis.

## IMPORTANT NOTICE

Texas Instruments Incorporated and its subsidiaries (TI) reserve the right to make corrections, modifications, enhancements, improvements, and other changes to its products and services at any time and to discontinue any product or service without notice. Customers should obtain the latest relevant information before placing orders and should verify that such information is current and complete. All products are sold subject to TI's terms and conditions of sale supplied at the time of order acknowledgment.

TI warrants performance of its hardware products to the specifications applicable at the time of sale in accordance with TI's standard warranty. Testing and other quality control techniques are used to the extent TI deems necessary to support this warranty. Except where mandated by government requirements, testing of all parameters of each product is not necessarily performed.

TI assumes no liability for applications assistance or customer product design. Customers are responsible for their products and applications using TI components. To minimize the risks associated with customer products and applications, customers should provide adequate design and operating safeguards.

TI does not warrant or represent that any license, either express or implied, is granted under any TI patent right, copyright, mask work right, or other TI intellectual property right relating to any combination, machine, or process in which TI products or services are used. Information published by TI regarding third-party products or services does not constitute a license from TI to use such products or services or a warranty or endorsement thereof. Use of such information may require a license from a third party under the patents or other intellectual property of the third party, or a license from TI under the patents or other intellectual property of TI.

Reproduction of information in TI data books or data sheets is permissible only if reproduction is without alteration and is accompanied by all associated warranties, conditions, limitations, and notices. Reproduction of this information with alteration is an unfair and deceptive business practice. TI is not responsible or liable for such altered documentation.

Resale of TI products or services with statements different from or beyond the parameters stated by TI for that product or service voids all express and any implied warranties for the associated TI product or service and is an unfair and deceptive business practice. TI is not responsible or liable for any such statements.

Following are URLs where you can obtain information on other Texas Instruments products and application solutions:

<b>Products</b>		<b>Applications</b>	
Amplifiers	<a href="http://amplifier.ti.com">amplifier.ti.com</a>	Audio	<a href="http://www.ti.com/audio">www.ti.com/audio</a>
Data Converters	<a href="http://dataconverter.ti.com">dataconverter.ti.com</a>	Automotive	<a href="http://www.ti.com/automotive">www.ti.com/automotive</a>
DSP	<a href="http://dsp.ti.com">dsp.ti.com</a>	Broadband	<a href="http://www.ti.com/broadband">www.ti.com/broadband</a>
Interface	<a href="http://interface.ti.com">interface.ti.com</a>	Digital Control	<a href="http://www.ti.com/digitalcontrol">www.ti.com/digitalcontrol</a>
Logic	<a href="http://logic.ti.com">logic.ti.com</a>	Military	<a href="http://www.ti.com/military">www.ti.com/military</a>
Power Mgmt	<a href="http://power.ti.com">power.ti.com</a>	Optical Networking	<a href="http://www.ti.com/opticalnetwork">www.ti.com/opticalnetwork</a>
Microcontrollers	<a href="http://microcontroller.ti.com">microcontroller.ti.com</a>	Security	<a href="http://www.ti.com/security">www.ti.com/security</a>
		Telephony	<a href="http://www.ti.com/telephony">www.ti.com/telephony</a>
		Video & Imaging	<a href="http://www.ti.com/video">www.ti.com/video</a>
		Wireless	<a href="http://www.ti.com/wireless">www.ti.com/wireless</a>

Mailing Address: Texas Instruments  
Post Office Box 655303 Dallas, Texas 75265