

# **TPS56428EVM-534, 4-A, Regulator Evaluation Module**

This user's guide contains information for the TPS56428EVM-534 evaluation module as well as for the TPS56428. Included are the performance specifications, schematic, and the bill of materials of the TPS56428EVM-534.

### Contents

1	Introduction .....	3
2	Performance Specification Summary .....	3
3	Modifications .....	3
	3.1 Output Voltage Setpoint .....	3
	3.2 Output Filter and Closed-Loop Response .....	4
4	Test Setup and Results .....	4
	4.1 Input/Output Connections .....	4
	4.2 Start-Up Procedure .....	5
	4.3 Efficiency .....	5
	4.4 Load Regulation .....	6
	4.5 Line Regulation .....	7
	4.6 Load Transient Response .....	7
	4.7 Output Voltage Ripple .....	8
	4.8 Input Voltage Ripple .....	9
	4.9 Start-Up .....	10
	4.10 Shut-Down .....	11
5	Board Layout .....	12
	5.1 Layout .....	12
6	Schematic, Bill of Materials, and Reference .....	14
	6.1 Schematic .....	14
	6.2 Bill of Materials .....	15
	6.3 Reference .....	15

### List of Figures

1	TPS56428EVM-534 Efficiency .....	5
2	TPS56428EVM-534 Light-Load Efficiency.....	6
3	TPS56428EVM-534 Load Regulation, $V_{IN} = 5\text{ V}$ and $V_{IN} = 12\text{ V}$ .....	6
4	TPS56428EVM-534 Line Regulation.....	7
5	TPS56428EVM-534 Load Transient Response.....	7
6	TPS56428EVM-534 Output Voltage Ripple ( $I_{OUT} = 4\text{ A}$ ) .....	8
7	TPS56428EVM-534 Output Voltage Ripple ( $I_{OUT} = 500\text{ mA}$ ) .....	8
8	TPS56428EVM-534 Output Voltage Ripple ( $I_{OUT} = 1\text{ mA}$ ) .....	9
9	TPS56428EVM-534 Input Voltage Ripple .....	9
10	TPS56428EVM-534 Start-Up Relative to $V_{IN}$ with VREG5, PG and $V_{OUT}$ .....	10
11	TPS56428EVM-534 Start-Up Relative to EN with VREG5, PG and $V_{OUT}$ .....	10
12	TPS56428EVM-534 Shut-Down Relative to $V_{IN}$ with VREG5, PG and $V_{OUT}$ .....	11
13	TPS56428EVM-534 Shut-Down Relative to EN with VREG5, PG and $V_{OUT}$ .....	11

D-CAP2, Eco-mode are trademarks of Texas Instruments.

---

14	Top Assembly .....	12
15	Top Layer .....	12
16	Internal Layer 1 .....	13
17	Internal Layer 2 .....	13
18	Bottom Layer .....	13
19	TPS56428EVM-534 Schematic Diagram .....	14

**List of Tables**

1	Input Voltage and Output Current Summary .....	3
2	TPS56428EVM-534 Performance Specifications Summary .....	3
3	Output Voltages .....	4
4	Connection and Test Points .....	4
5	Bill of Materials .....	15

## 1 Introduction

The TPS56428 is a single, adaptive on-time, D-CAP2™-mode, synchronous buck converter requiring a low external component count. The D-CAP2 control circuit is optimized for low-ESR output capacitors such as POSCAP, SP-CAP, or ceramic types and features fast transient response with no external compensation. The switching frequency is internally set at a nominal 650 kHz. Pulse skipping Eco-mode™ operation improves efficiency under light load conditions. The high-side and low-side switching MOSFETs are incorporated inside the TPS56428 package along with the gate-drive circuitry. The low drain-to-source on-resistance of the MOSFETs allows the TPS56428 to achieve high efficiencies and helps keep the junction temperature low at high-output currents. The TPS56428 dc/dc synchronous converter is designed to provide up to a 4-A output from an input voltage source of 4.5 V to 18 V. The output voltage range is from 0.6 V to 7 V. Rated input voltage and output current range for the evaluation module are given in [Table 1](#).

The TPS56428EVM-534 evaluation module circuit is a single, synchronous buck converter providing 1.2 V at 4 A from 4.5-V to 18-V input. This user's guide describes the TPS56428EVM-534 performance.

**Table 1. Input Voltage and Output Current Summary**

EVM	Input Voltage Range	Output Current Range
TPS56428EVM-534	$V_{IN} = 4.5 \text{ V to } 18 \text{ V}$	0 A to 4 A

## 2 Performance Specification Summary

A summary of the TPS56428EVM-534 performance specifications is provided in [Table 2](#). Specifications are given for an input voltage of  $V_{IN} = 12 \text{ V}$  and an output voltage of 1.2 V, unless otherwise noted. The ambient temperature is 25°C for all measurement, unless otherwise noted.

**Table 2. TPS56428EVM-534 Performance Specifications Summary**

Specifications	Test Conditions	Min	Typ	Max	Unit
Input voltage range ( $V_{IN}$ )		4.5	12	18	V
Output voltage			1.2		V
Operating frequency	$V_{IN} = 12 \text{ V}, I_O = 2 \text{ A}$		650		kHz
Output current range		0		4	A
Line regulation	$I_O = 2 \text{ A}$		$\pm 0.12$		%
Load regulation	$V_{IN} = 12 \text{ V}$		$+0.9 / -0.1$		%
Overcurrent limit	$V_{IN} = 12 \text{ V}, L_O = 1.5 \mu\text{H}$	4.8	5.6	7.0	A
Output ripple voltage	$V_{IN} = 12 \text{ V}, I_O = 4 \text{ A}$		10		mV <sub>PP</sub>
Maximum efficiency	$V_{IN} = 5 \text{ V}, I_O = 0.7 \text{ A}$		89.8		%

## 3 Modifications

These evaluation modules are designed to provide access to the features of the TPS56428. Some modifications can be made to this module.

### 3.1 Output Voltage Setpoint

To change the output voltage of the EVMs, it is necessary to change the value of resistor R1. Changing the value of R1 can change the output voltage above 0.765 V. The value of R1 for a specific output voltage can be calculated using [Equation 1](#).

For output voltage from 0.6 V to 7 V:

$$V_O = 0.6 \times \left( 1 + \frac{R_1}{R_2} \right) \quad (1)$$

Table 3 lists the R1 values for some common output voltages. For higher output voltages of 1.8 V or above, a feed-forward capacitor (C4) may be required to improve phase margin. Pads for this component (C4) are provided on the printed-circuit board (PCB). Note that the resistor values given in Table 3 are standard values and not the exact value calculated using Equation 1.

**Table 3. Output Voltages**

Output Voltage (V)	R1 (kΩ)	R2 (kΩ)	C4 (pF) <sup>(1)</sup>			L1 (μH)			C9 + C10 + C11 (μF)	
			Min	Typ	Max	Min	Typ	Max	Min	Max
1	33.2	49.9	5	33	100	1.0	1.5	4.7	20	68
1.05	37.4	49.9	5	33	100	1.0	1.5	4.7	20	68
1.2	49.9	49.9	5	22	1.0	1.0	1.5	4.7	20	68
1.5	75.0	49.9	5	15	33	1.0	1.5	4.7	20	68
1.8	100	49.9	5	10	22	1.0	1.5	4.7	20	68
2.5	158	49.9	5	10	22	1.5	2.2	4.7	20	68
3.3	226	49.9	2	5	15	1.5	2.2	4.7	20	68
5	365	49.9	2	5	10	2.2	3.3	4.7	20	68
6.5	487	2	2	5	10	2.2	3.3	4.7	20	68

<sup>(1)</sup> Optional

### 3.2 Output Filter and Closed-Loop Response

The TPS56428 relies on the output filter characteristics to ensure stability of the control loop. The recommended output filter components for common output voltages are given in Table 3. It may be possible for other output filter component values to provide acceptable closed-loop characteristics. R3 and TP4 are provided for convenience in breaking the control loop and measuring the closed-loop response.

## 4 Test Setup and Results

This section describes how to properly connect, set up, and use the TPS56428EVM-534. The section also includes test results typical for the evaluation modules and efficiency, output load regulation, output line regulation, load transient response, output voltage ripple, input voltage ripple, start-up, and switching frequency.

### 4.1 Input/Output Connections

The TPS56428EVM-534 is provided with input and output connectors and test points as shown in Table 4. A power supply capable of supplying 2 A must be connected to J1 through a pair of 20-AWG wires. The load must be connected to J2 through a pair of 20-AWG wires. The maximum load current capability is 2 A. Wire lengths must be minimized to reduce losses in the wires. Test point TP1 provides a place to monitor the  $V_{IN}$  input voltages with TP2 providing a convenient ground reference. TP8 is used to monitor the output voltage with TP9 as the ground reference.

**Table 4. Connection and Test Points**

Reference Designator	Function
J1	$V_{IN}$ (see Table 1 for $V_{IN}$ range)
J2	$V_{OUT}$ , 1.2 V at 4-A maximum
JP1	EN control. Connect EN to OFF to disable, connect EN to ON to enable
TP1	$V_{IN}$ test point at $V_{IN}$ connector
TP2	GND test point at $V_{IN}$ connector.
TP3	EN test point
TP4	Power good (PG) test point
TP5	Switch node test point
TP6	Analog ground test point
TP7	Power ground test point

**Table 4. Connection and Test Points (continued)**

Reference Designator	Function
TP8	Output voltage test point at V <sub>OUT</sub> connector
TP9	Ground test point at V <sub>OUT</sub> connector

**4.2 Start-Up Procedure**

1. Ensure that the jumper at JP1 (Enable control) is set from EN to OFF.
2. Apply appropriate V<sub>IN</sub> voltage to VIN and PGND terminals at J1.
3. Move the jumper at JP1 (Enable control) to cover EN and ON. The EVM enables the output voltage.

**4.3 Efficiency**

Figure 1 shows the efficiency for the TPS56428EVM-534 at an ambient temperature of 25°C.

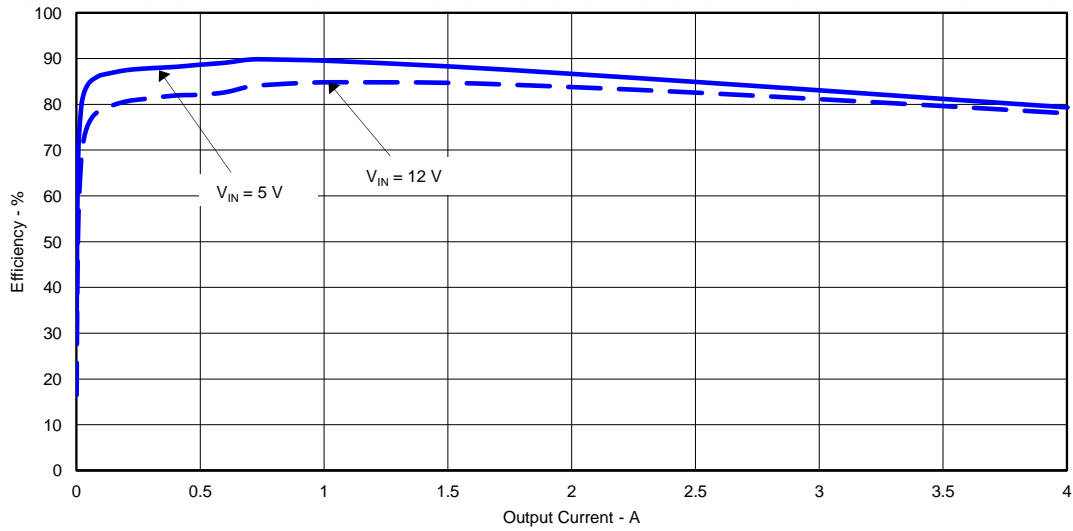

**Figure 1. TPS56428EVM-534 Efficiency**

Figure 2 shows the efficiency at light loads for the TPS56428EVM-534 at an ambient temperature of 25°C.

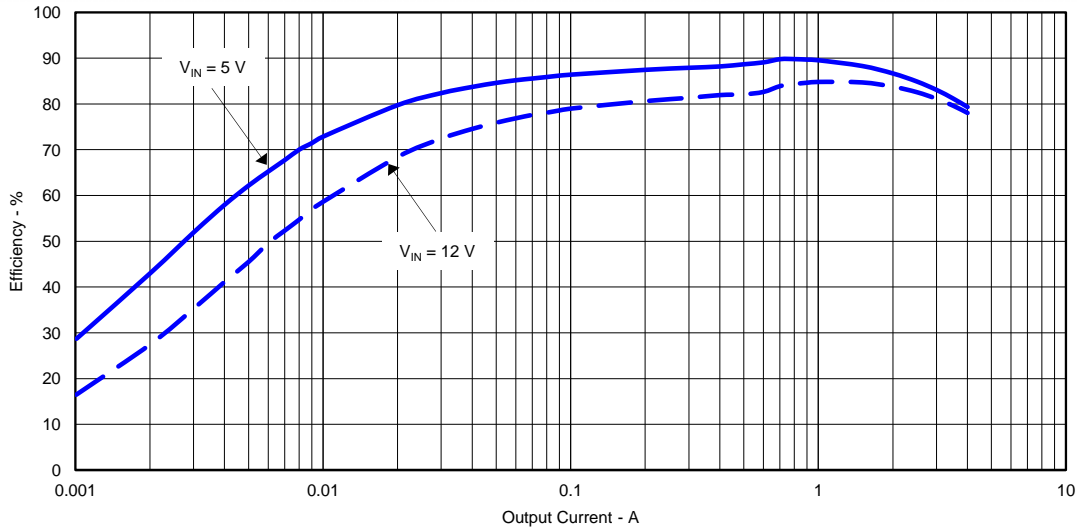

Figure 2. TPS56428EVM-534 Light-Load Efficiency

#### 4.4 Load Regulation

The load regulation for the TPS56428EVM-534 is shown in Figure 3.

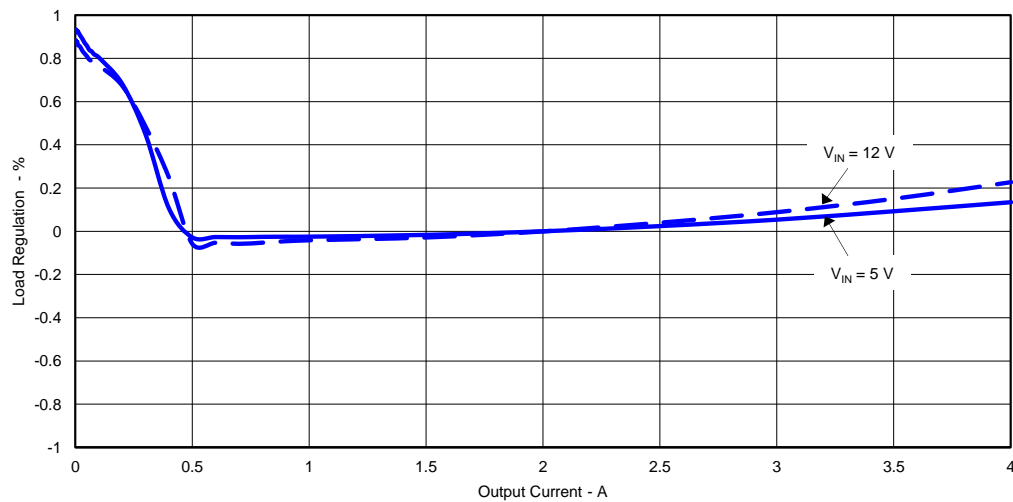

Figure 3. TPS56428EVM-534 Load Regulation,  $V_{IN} = 5\text{ V}$  and  $V_{IN} = 12\text{ V}$

### 4.5 Line Regulation

The line regulation for the TPS56428EVM-534 is shown in Figure 4.

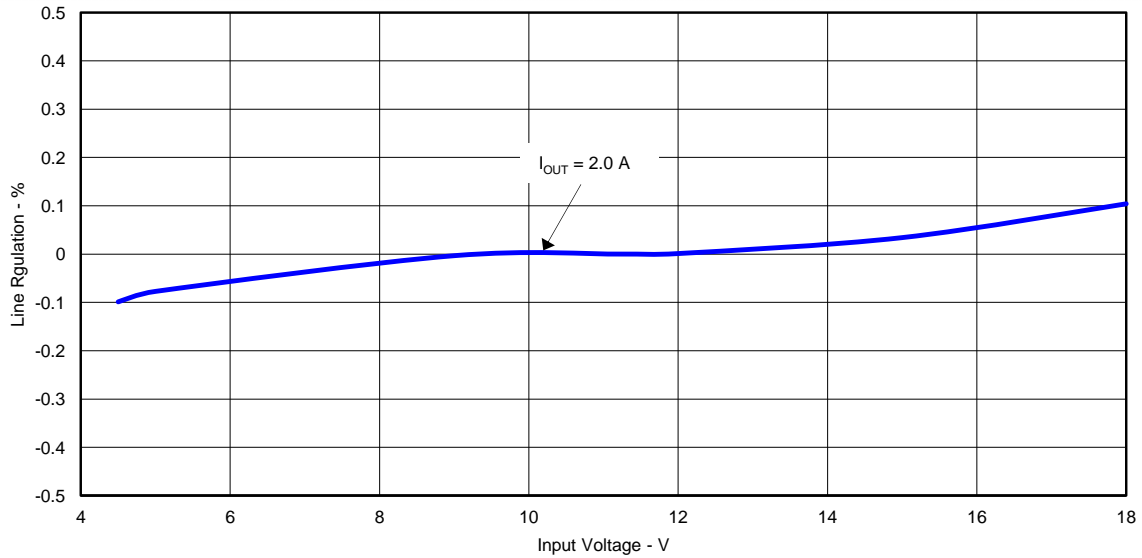

Figure 4. TPS56428EVM-534 Line Regulation

### 4.6 Load Transient Response

The TPS56428EVM-534 response to load transient is shown in Figure 5. The current step is from 1.0 A to 3.0 A. Total peak-to-peak voltage variation is as shown.

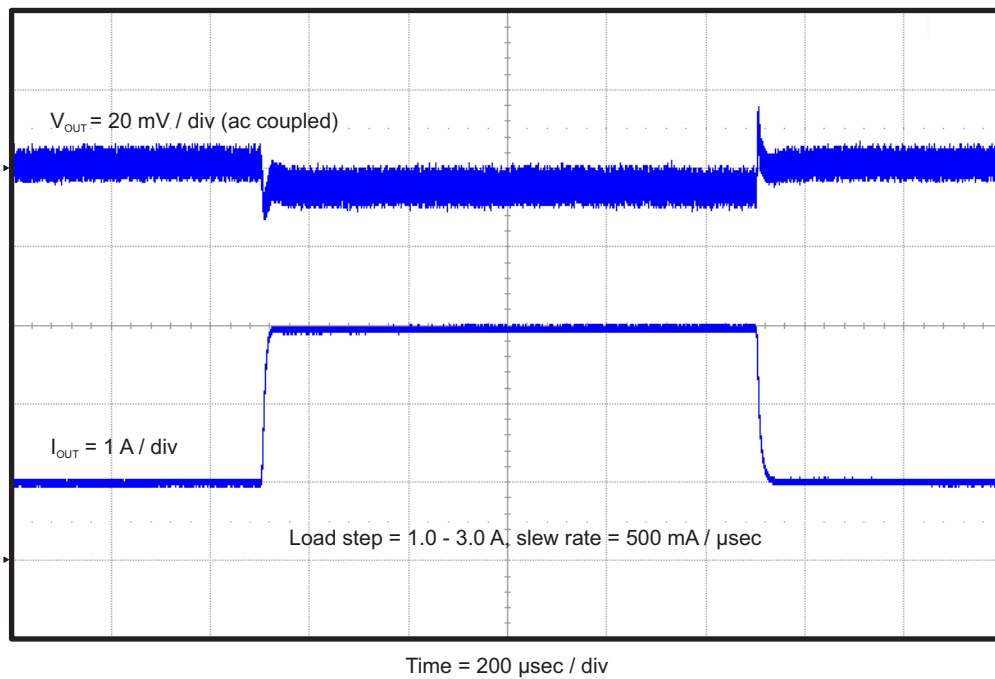
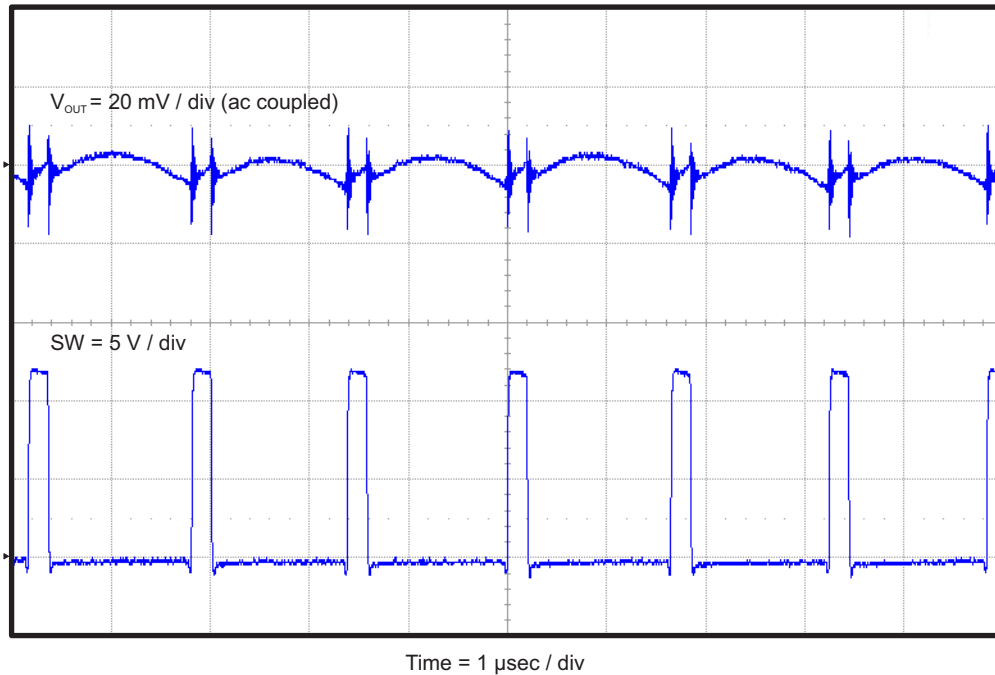

Figure 5. TPS56428EVM-534 Load Transient Response

## 4.7 Output Voltage Ripple

The TPS56428EVM-534 output voltage ripple is shown in Figure 6. The output current is the rated full load of 4 A.



**Figure 6. TPS56428EVM-534 Output Voltage Ripple ( $I_{OUT} = 4 \text{ A}$ )**

The TPS56428EVM-534 output voltage ripple is shown in Figure 7. The output current is 500 mA.

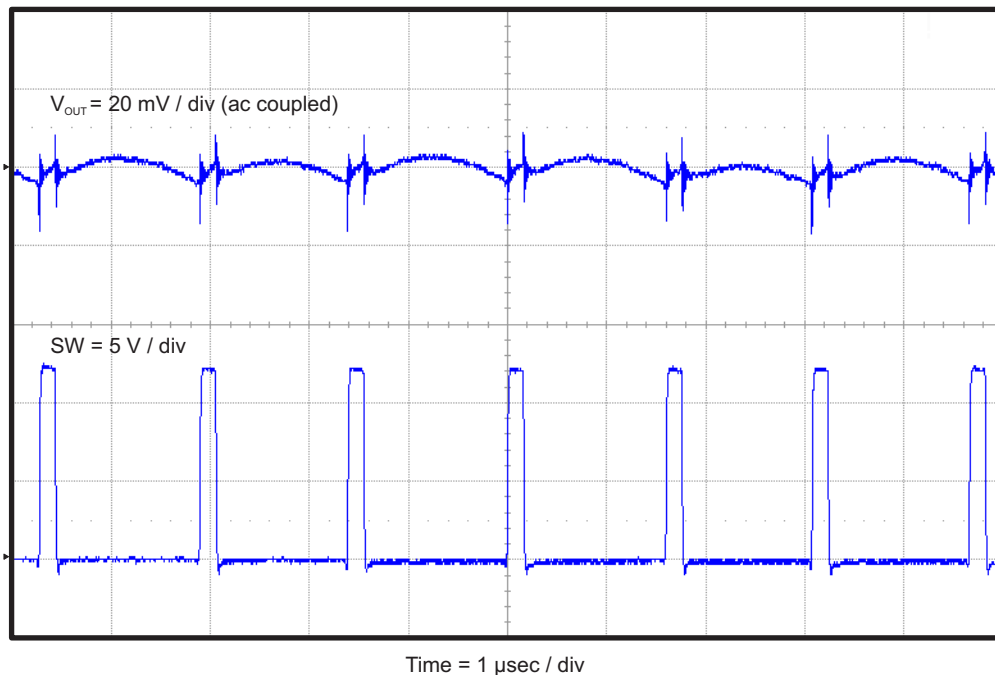

**Figure 7. TPS56428EVM-534 Output Voltage Ripple ( $I_{OUT} = 500 \text{ mA}$ )**



The TPS56428EVM-534 output voltage ripple is shown in Figure 8. The output current is 1 m A.

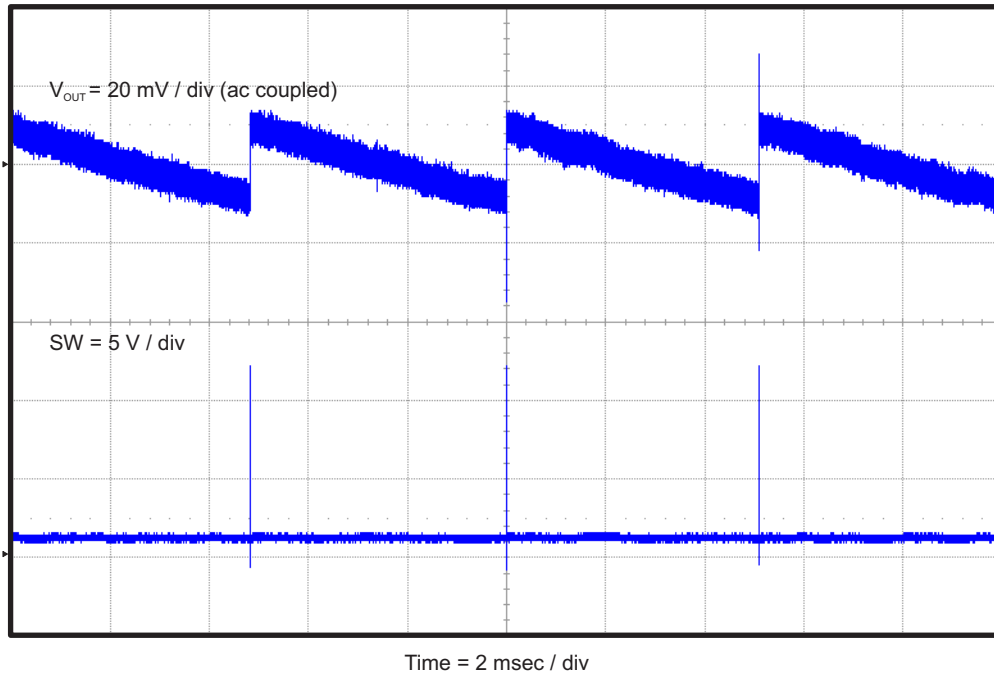

Figure 8. TPS56428EVM-534 Output Voltage Ripple ( $I_{OUT} = 1 \text{ mA}$ )

#### 4.8 Input Voltage Ripple

The TPS56428EVM-534 input voltage ripple is shown in Figure 9. The output current is the rated full load of 4 A.

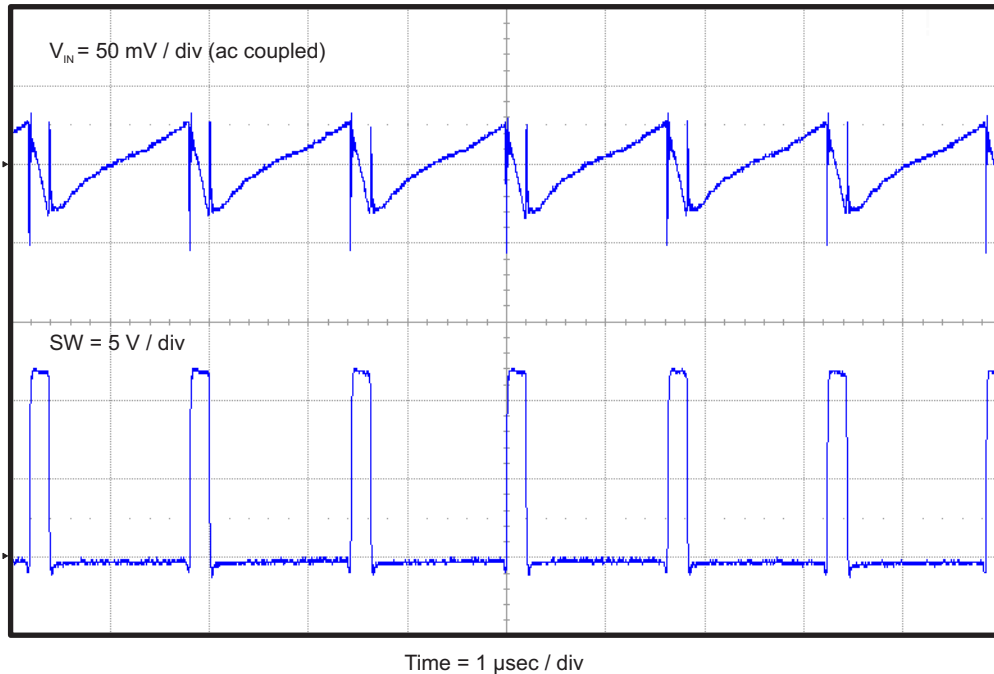

Figure 9. TPS56428EVM-534 Input Voltage Ripple

## 4.9 Start-Up

The TPS56428EVM-534 start-up waveforms relative to  $V_{IN}$  and EN are shown in Figure 10 and Figure 11.  $R_{LOAD} = 1 \Omega$ .

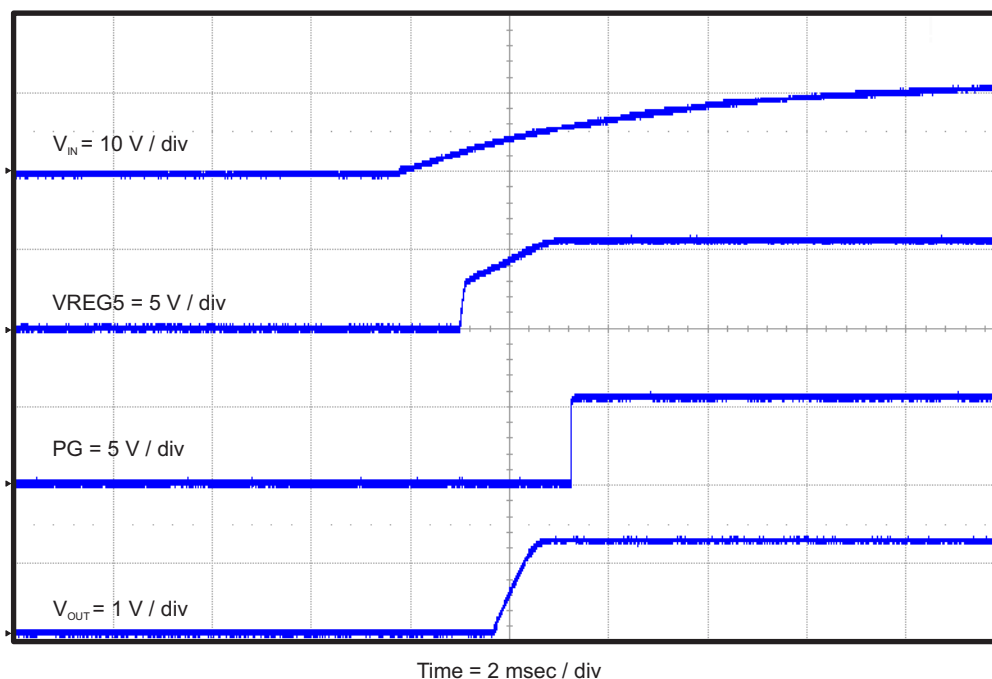

Figure 10. TPS56428EVM-534 Start-Up Relative to  $V_{IN}$  with VREG5, PG and  $V_{OUT}$

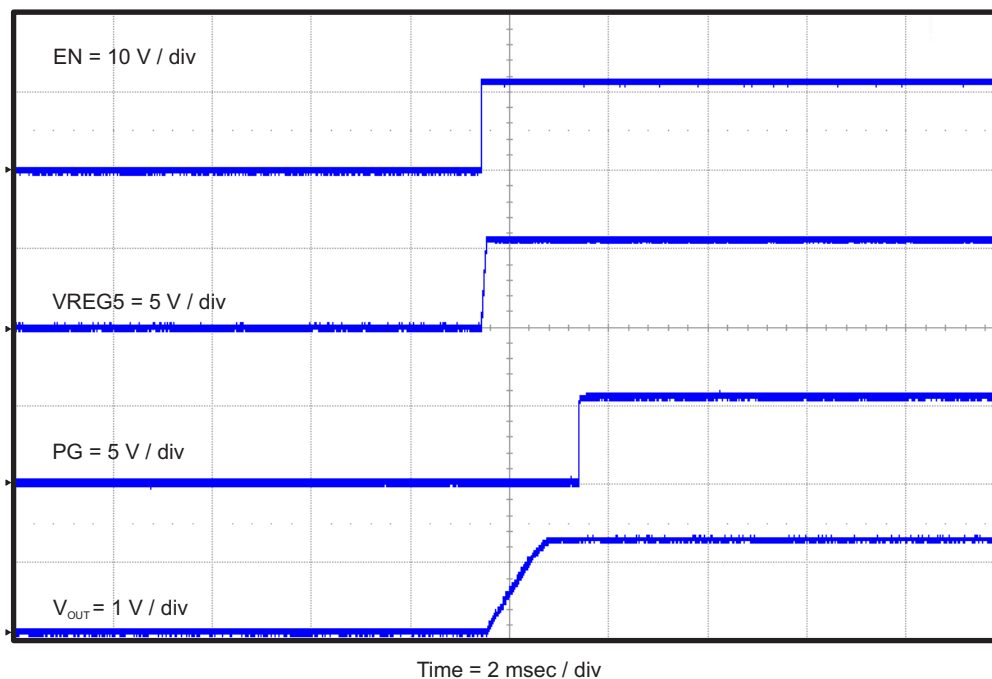

Figure 11. TPS56428EVM-534 Start-Up Relative to EN with VREG5, PG and  $V_{OUT}$

### 4.10 Shut-Down

The TPS56428EVM-534 shut-down waveforms relative to  $V_{IN}$  and EN are shown in Figure 12 and Figure 13.  $R_{LOAD} = 1 \Omega$ .

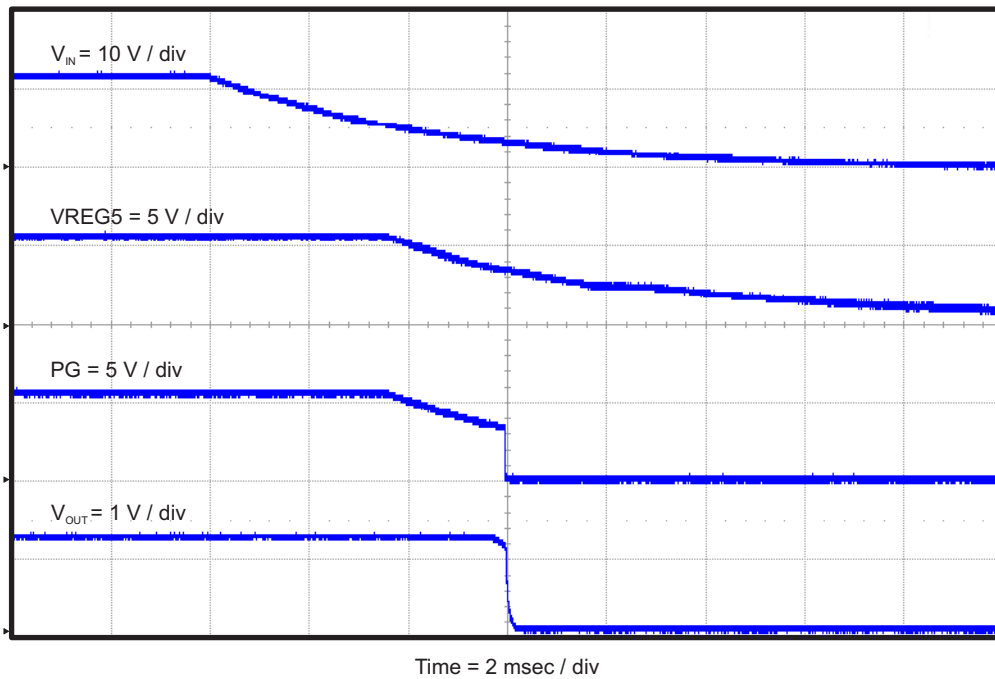

Figure 12. TPS56428EVM-534 Shut-Down Relative to  $V_{IN}$  with VREG5, PG and  $V_{OUT}$

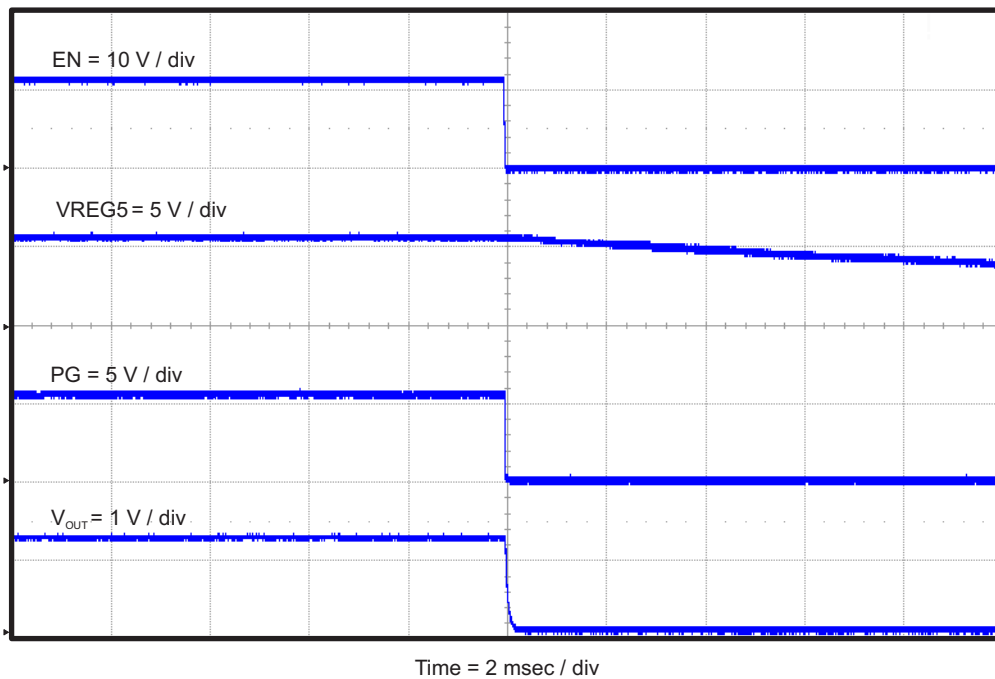

Figure 13. TPS56428EVM-534 Shut-Down Relative to EN with VREG5, PG and  $V_{OUT}$

## 5 Board Layout

This section provides description of the TPS56428EVM-534, board layout, and layer illustrations.

### 5.1 Layout

The board layout for the TPS56428EVM-534 is shown in [Figure 14](#) through [Figure 18](#). The top layer contains the main power traces for VIN, VOUT, and ground. Also on the top layer are connections for the pins of the TPS56428 and a large area filled with ground. Many of the signal traces also are located on the top side. The input decoupling capacitors are located as close to the IC as possible. The input and output connectors, test points, and all of the components are located on the top side. Internal layer 1, Internal layer 2 and the bottom layer are predominantly power ground planes. An analog ground (AGND) area is provided on internal layer 1. Analog ground (AGND) and power ground (PGND) are connected at a single point on the internal layer 1 as shown. Internal layer 2 contains an additional VIN area as well as a connection to the VIN pin of the EN control jumper JP1. The bottom layer contains the output voltage feedback trace.

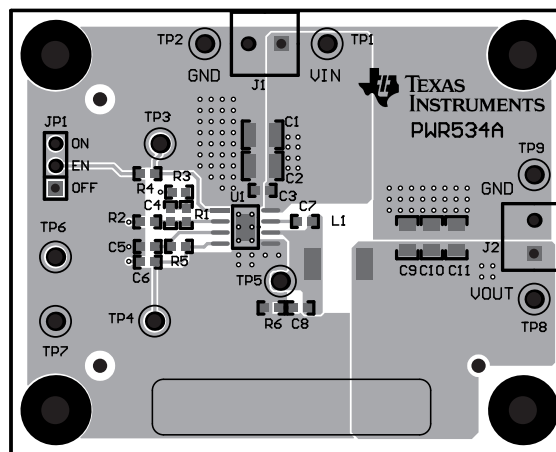

**Figure 14. Top Assembly**

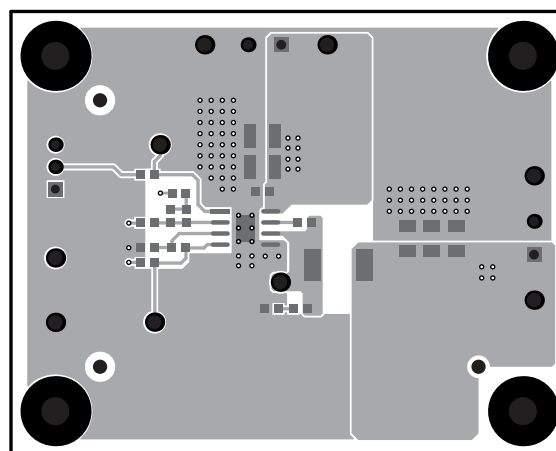

**Figure 15. Top Layer**

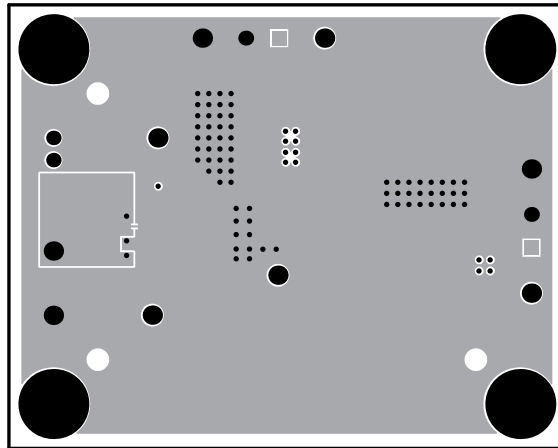

Figure 16. Internal Layer 1

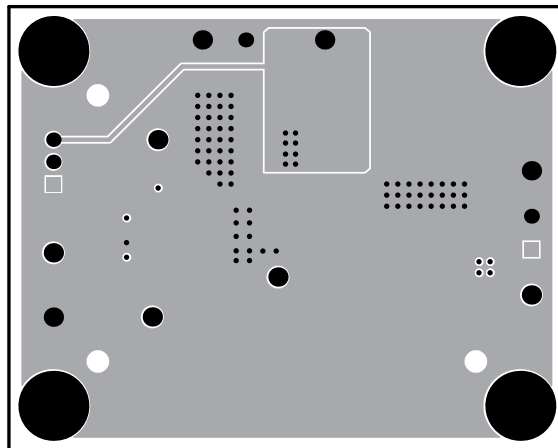

Figure 17. Internal Layer 2

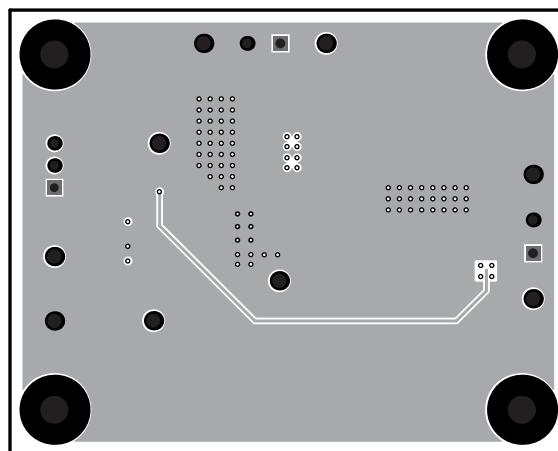
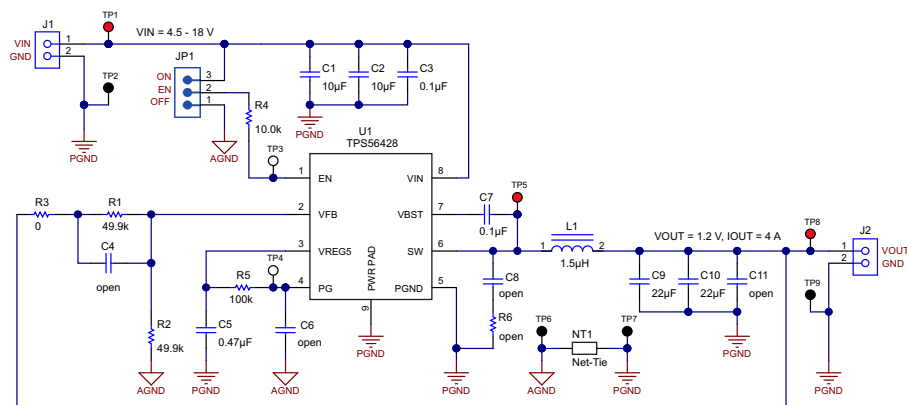

Figure 18. Bottom Layer

## 6 Schematic, Bill of Materials, and Reference

### 6.1 Schematic

Figure 19 is the schematic for the TPS56428EVM-534.



**Figure 19. TPS56428EVM-534 Schematic Diagram**

## 6.2 Bill of Materials

**Table 5. Bill of Materials**

Designator	Qty	Value	Description	Package Reference	Part Number	Manufacturer
PCB	1		Printed Circuit Board	2.00" x 2.50"	PWR534A	Any
C1, C2	2	10uF	CAP, CERM, 10uF, 35V, +10/%, X7R, 1210	1210	GRM32ER7YA106KA12L	MuRata
C3, C7	2	0.1uF	CAP, CERM, 0.1uF, 50V, +10/%, X7R, 0603	0603	GRM188R71H104KA93D	MuRata
C4, C6, C8	0		CAP, CERM, xxxF, xxV, [TempCo], xx%, 0603	0603		
C5	1	0.47uF	CAP, CERM, 0.47uF, 25V, +10/%, X5R, 0603	0603	GRM188R61E474KA12D	MuRata
C9, C10	2	22uF	CAP, CERM, 22uF, 10V, +10/%, X5R, 1206	1206	GRM31CR61A226KE19L	MuRata
C11	0		CAP, CERM, xxxF, xxV, [TempCo], xx%, 1206	1206		
FID1, FID2, FID3	0		Fiducial mark. There is nothing to buy or mount.	Fiducial	N/A	N/A
J1, J2	2	2x1	Conn Term Block, 2POS, 3.81mm, TH	PhoenixConact_1727010	1727010	Phoenix Contact
JP1	1	1x3	Header, TH, 100mil, 1x3, Gold plated, 230 mil above insulator	PBC03SAAN	PBC03SAAN	Sullins Connector Solutions
L1	1	1.5uH	Inductor, SMT, 11A, 9.7 milliohm	0.256 x 0.280 inch	SPM6530-1R5M100	TDK
LBL1	1		Thermal Transfer Printable Labels, 1.25" W x 0.25" H - 10,000 per roll	PCB Label 1.25"H x 0.25"W	THT-13-457-10	Brady
R1, R2	2	49.9k	RES, 49.9k ohm, 1%, 0.1W, 0603	0603	CRCW060349K9FKEA	Vishay-Dale
R3	1	0	RES, 0 ohm, 5%, 0.1W, 0603	0603	MCR03EZIP000	Rohm
R4	1	10.0k	RES, 10.0k ohm, 1%, 0.1W, 0603	0603	CRCW060310K0FKEA	Vishay-Dale
R5	1	100k	RES, 100k ohm, 1%, 0.1W, 0603	0603	CRCW0603100KFKEA	Vishay-Dale
R6	0		RES, xxx ohm, x%, xW, 0603	0603		
SH-JP1	1	1x2	Shunt, 100mil, Gold plated, Black	Shunt	969102-0000-DA	3M
TP1, TP5, TP8	3	Red	Test Point, TH, Multipurpose, Red	Keystone5010	5010	Keystone
TP2, TP6, TP7, TP9	4	Black	Test Point, TH, Multipurpose, Black	Keystone5011	5011	Keystone
TP3, TP4	2	White	Test Point, TH, Multipurpose, White	Keystone5012	5012	Keystone
U1	1		DC-DC Converter, 4.5 - 18 Vin, 4A	SOP8	TPS56428DDA	Texas Instruments

## 6.3 Reference

1. [TPS56428, 4.5-V to 18-V Input, 4-A Synchronous Step-Down SWIFT™ Converter data sheet \(SLVSBV4\)](#)

## EVALUATION BOARD/KIT/MODULE (EVM) ADDITIONAL TERMS

Texas Instruments (TI) provides the enclosed Evaluation Board/Kit/Module (EVM) under the following conditions:

The user assumes all responsibility and liability for proper and safe handling of the goods. Further, the user indemnifies TI from all claims arising from the handling or use of the goods.

Should this evaluation board/kit not meet the specifications indicated in the User's Guide, the board/kit may be returned within 30 days from the date of delivery for a full refund. THE FOREGOING LIMITED WARRANTY IS THE EXCLUSIVE WARRANTY MADE BY SELLER TO BUYER AND IS IN LIEU OF ALL OTHER WARRANTIES, EXPRESSED, IMPLIED, OR STATUTORY, INCLUDING ANY WARRANTY OF MERCHANTABILITY OR FITNESS FOR ANY PARTICULAR PURPOSE. EXCEPT TO THE EXTENT OF THE INDEMNITY SET FORTH ABOVE, NEITHER PARTY SHALL BE LIABLE TO THE OTHER FOR ANY INDIRECT, SPECIAL, INCIDENTAL, OR CONSEQUENTIAL DAMAGES.

Please read the User's Guide and, specifically, the Warnings and Restrictions notice in the User's Guide prior to handling the product. This notice contains important safety information about temperatures and voltages. For additional information on TI's environmental and/or safety programs, please visit [www.ti.com/esh](http://www.ti.com/esh) or contact TI.

No license is granted under any patent right or other intellectual property right of TI covering or relating to any machine, process, or combination in which such TI products or services might be or are used. TI currently deals with a variety of customers for products, and therefore our arrangement with the user is not exclusive. TI assumes no liability for applications assistance, customer product design, software performance, or infringement of patents or services described herein.

## REGULATORY COMPLIANCE INFORMATION

As noted in the EVM User's Guide and/or EVM itself, this EVM and/or accompanying hardware may or may not be subject to the Federal Communications Commission (FCC) and Industry Canada (IC) rules.

For EVMs **not** subject to the above rules, this evaluation board/kit/module is intended for use for ENGINEERING DEVELOPMENT, DEMONSTRATION OR EVALUATION PURPOSES ONLY and is not considered by TI to be a finished end product fit for general consumer use. It generates, uses, and can radiate radio frequency energy and has not been tested for compliance with the limits of computing devices pursuant to part 15 of FCC or ICES-003 rules, which are designed to provide reasonable protection against radio frequency interference. Operation of the equipment may cause interference with radio communications, in which case the user at his own expense will be required to take whatever measures may be required to correct this interference.

### General Statement for EVMs including a radio

*User Power/Frequency Use Obligations:* This radio is intended for development/professional use only in legally allocated frequency and power limits. Any use of radio frequencies and/or power availability of this EVM and its development application(s) must comply with local laws governing radio spectrum allocation and power limits for this evaluation module. It is the user's sole responsibility to only operate this radio in legally acceptable frequency space and within legally mandated power limitations. Any exceptions to this are strictly prohibited and unauthorized by Texas Instruments unless user has obtained appropriate experimental/development licenses from local regulatory authorities, which is responsibility of user including its acceptable authorization.

### For EVMs annotated as FCC – FEDERAL COMMUNICATIONS COMMISSION Part 15 Compliant

#### Caution

This device complies with part 15 of the FCC Rules. Operation is subject to the following two conditions: (1) This device may not cause harmful interference, and (2) this device must accept any interference received, including interference that may cause undesired operation.

Changes or modifications not expressly approved by the party responsible for compliance could void the user's authority to operate the equipment.

### FCC Interference Statement for Class A EVM devices

This equipment has been tested and found to comply with the limits for a Class A digital device, pursuant to part 15 of the FCC Rules. These limits are designed to provide reasonable protection against harmful interference when the equipment is operated in a commercial environment. This equipment generates, uses, and can radiate radio frequency energy and, if not installed and used in accordance with the instruction manual, may cause harmful interference to radio communications. Operation of this equipment in a residential area is likely to cause harmful interference in which case the user will be required to correct the interference at his own expense.



### **FCC Interference Statement for Class B EVM devices**

This equipment has been tested and found to comply with the limits for a Class B digital device, pursuant to part 15 of the FCC Rules. These limits are designed to provide reasonable protection against harmful interference in a residential installation. This equipment generates, uses and can radiate radio frequency energy and, if not installed and used in accordance with the instructions, may cause harmful interference to radio communications. However, there is no guarantee that interference will not occur in a particular installation. If this equipment does cause harmful interference to radio or television reception, which can be determined by turning the equipment off and on, the user is encouraged to try to correct the interference by one or more of the following measures:

- Reorient or relocate the receiving antenna.
- Increase the separation between the equipment and receiver.
- Connect the equipment into an outlet on a circuit different from that to which the receiver is connected.
- Consult the dealer or an experienced radio/TV technician for help.

### **For EVMs annotated as IC – INDUSTRY CANADA Compliant**

This Class A or B digital apparatus complies with Canadian ICES-003.

Changes or modifications not expressly approved by the party responsible for compliance could void the user's authority to operate the equipment.

### **Concerning EVMs including radio transmitters**

This device complies with Industry Canada licence-exempt RSS standard(s). Operation is subject to the following two conditions: (1) this device may not cause interference, and (2) this device must accept any interference, including interference that may cause undesired operation of the device.

### **Concerning EVMs including detachable antennas**

Under Industry Canada regulations, this radio transmitter may only operate using an antenna of a type and maximum (or lesser) gain approved for the transmitter by Industry Canada. To reduce potential radio interference to other users, the antenna type and its gain should be so chosen that the equivalent isotropically radiated power (e.i.r.p.) is not more than that necessary for successful communication.

This radio transmitter has been approved by Industry Canada to operate with the antenna types listed in the user guide with the maximum permissible gain and required antenna impedance for each antenna type indicated. Antenna types not included in this list, having a gain greater than the maximum gain indicated for that type, are strictly prohibited for use with this device.

Cet appareil numérique de la classe A ou B est conforme à la norme NMB-003 du Canada.

Les changements ou les modifications pas expressément approuvés par la partie responsable de la conformité ont pu vider l'autorité de l'utilisateur pour actionner l'équipement.

### **Concernant les EVMs avec appareils radio**

Le présent appareil est conforme aux CNR d'Industrie Canada applicables aux appareils radio exempts de licence. L'exploitation est autorisée aux deux conditions suivantes : (1) l'appareil ne doit pas produire de brouillage, et (2) l'utilisateur de l'appareil doit accepter tout brouillage radioélectrique subi, même si le brouillage est susceptible d'en compromettre le fonctionnement.

### **Concernant les EVMs avec antennes détachables**

Conformément à la réglementation d'Industrie Canada, le présent émetteur radio peut fonctionner avec une antenne d'un type et d'un gain maximal (ou inférieur) approuvé pour l'émetteur par Industrie Canada. Dans le but de réduire les risques de brouillage radioélectrique à l'intention des autres utilisateurs, il faut choisir le type d'antenne et son gain de sorte que la puissance isotrope rayonnée équivalente (p.i.r.e.) ne dépasse pas l'intensité nécessaire à l'établissement d'une communication satisfaisante.

Le présent émetteur radio a été approuvé par Industrie Canada pour fonctionner avec les types d'antenne énumérés dans le manuel d'usage et ayant un gain admissible maximal et l'impédance requise pour chaque type d'antenne. Les types d'antenne non inclus dans cette liste, ou dont le gain est supérieur au gain maximal indiqué, sont strictement interdits pour l'exploitation de l'émetteur.

## **【Important Notice for Users of this Product in Japan】**

**This development kit is NOT certified as Confirming to Technical Regulations of Radio Law of Japan**

If you use this product in Japan, you are required by Radio Law of Japan to follow the instructions below with respect to this product:

1. Use this product in a shielded room or any other test facility as defined in the notification #173 issued by Ministry of Internal Affairs and Communications on March 28, 2006, based on Sub-section 1.1 of Article 6 of the Ministry's Rule for Enforcement of Radio Law of Japan,
2. Use this product only after you obtained the license of Test Radio Station as provided in Radio Law of Japan with respect to this product, or
3. Use of this product only after you obtained the Technical Regulations Conformity Certification as provided in Radio Law of Japan with respect to this product. Also, please do not transfer this product, unless you give the same notice above to the transferee. Please note that if you could not follow the instructions above, you will be subject to penalties of Radio Law of Japan.

**Texas Instruments Japan Limited**  
**(address) 24-1, Nishi-Shinjuku 6 chome, Shinjuku-ku, Tokyo, Japan**

<http://www.tij.co.jp>

### **【ご使用にあたっての注】**

本開発キットは技術基準適合証明を受けておりません。

本製品のご使用に際しては、電波法遵守のため、以下のいずれかの措置を取っていただく必要がありますのでご注意ください。

1. 電波法施行規則第6条第1項第1号に基づく平成18年3月28日総務省告示第173号で定められた電波暗室等の試験設備でご使用いただく。
2. 実験局の免許を取得後ご使用いただく。
3. 技術基準適合証明を取得後ご使用いただく。

なお、本製品は、上記の「ご使用にあたっての注意」を譲渡先、移転先に通知しない限り、譲渡、移転できないものとします。

上記を遵守頂けない場合は、電波法の罰則が適用される可能性があることをご留意ください。

日本テキサス・インスツルメンツ株式会社  
東京都新宿区西新宿6丁目24番1号  
西新宿三井ビル

<http://www.tij.co.jp>

## EVALUATION BOARD/KIT/MODULE (EVM) WARNINGS, RESTRICTIONS AND DISCLAIMERS

**For Feasibility Evaluation Only, in Laboratory/Development Environments.** Unless otherwise indicated, this EVM is not a finished electrical equipment and not intended for consumer use. It is intended solely for use for preliminary feasibility evaluation in laboratory/development environments by technically qualified electronics experts who are familiar with the dangers and application risks associated with handling electrical mechanical components, systems and subsystems. It should not be used as all or part of a finished end product.

Your Sole Responsibility and Risk. You acknowledge, represent and agree that:

1. You have unique knowledge concerning Federal, State and local regulatory requirements (including but not limited to Food and Drug Administration regulations, if applicable) which relate to your products and which relate to your use (and/or that of your employees, affiliates, contractors or designees) of the EVM for evaluation, testing and other purposes.
2. You have full and exclusive responsibility to assure the safety and compliance of your products with all such laws and other applicable regulatory requirements, and also to assure the safety of any activities to be conducted by you and/or your employees, affiliates, contractors or designees, using the EVM. Further, you are responsible to assure that any interfaces (electronic and/or mechanical) between the EVM and any human body are designed with suitable isolation and means to safely limit accessible leakage currents to minimize the risk of electrical shock hazard.
3. You will employ reasonable safeguards to ensure that your use of the EVM will not result in any property damage, injury or death, even if the EVM should fail to perform as described or expected.
4. You will take care of proper disposal and recycling of the EVM's electronic components and packing materials.

**Certain Instructions.** It is important to operate this EVM within TI's recommended specifications and environmental considerations per the user guidelines. Exceeding the specified EVM ratings (including but not limited to input and output voltage, current, power, and environmental ranges) may cause property damage, personal injury or death. If there are questions concerning these ratings please contact a TI field representative prior to connecting interface electronics including input power and intended loads. Any loads applied outside of the specified output range may result in unintended and/or inaccurate operation and/or possible permanent damage to the EVM and/or interface electronics. Please consult the EVM User's Guide prior to connecting any load to the EVM output. If there is uncertainty as to the load specification, please contact a TI field representative. During normal operation, some circuit components may have case temperatures greater than 60°C as long as the input and output are maintained at a normal ambient operating temperature. These components include but are not limited to linear regulators, switching transistors, pass transistors, and current sense resistors which can be identified using the EVM schematic located in the EVM User's Guide. When placing measurement probes near these devices during normal operation, please be aware that these devices may be very warm to the touch. As with all electronic evaluation tools, only qualified personnel knowledgeable in electronic measurement and diagnostics normally found in development environments should use these EVMs.

**Agreement to Defend, Indemnify and Hold Harmless.** You agree to defend, indemnify and hold TI, its licensors and their representatives harmless from and against any and all claims, damages, losses, expenses, costs and liabilities (collectively, "Claims") arising out of or in connection with any use of the EVM that is not in accordance with the terms of the agreement. This obligation shall apply whether Claims arise under law of tort or contract or any other legal theory, and even if the EVM fails to perform as described or expected.

**Safety-Critical or Life-Critical Applications.** If you intend to evaluate the components for possible use in safety critical applications (such as life support) where a failure of the TI product would reasonably be expected to cause severe personal injury or death, such as devices which are classified as FDA Class III or similar classification, then you must specifically notify TI of such intent and enter into a separate Assurance and Indemnity Agreement.

Mailing Address: Texas Instruments, Post Office Box 655303, Dallas, Texas 75265  
Copyright © 2012, Texas Instruments Incorporated

## IMPORTANT NOTICE

Texas Instruments Incorporated and its subsidiaries (TI) reserve the right to make corrections, enhancements, improvements and other changes to its semiconductor products and services per JESD46, latest issue, and to discontinue any product or service per JESD48, latest issue. Buyers should obtain the latest relevant information before placing orders and should verify that such information is current and complete. All semiconductor products (also referred to herein as "components") are sold subject to TI's terms and conditions of sale supplied at the time of order acknowledgment.

TI warrants performance of its components to the specifications applicable at the time of sale, in accordance with the warranty in TI's terms and conditions of sale of semiconductor products. Testing and other quality control techniques are used to the extent TI deems necessary to support this warranty. Except where mandated by applicable law, testing of all parameters of each component is not necessarily performed.

TI assumes no liability for applications assistance or the design of Buyers' products. Buyers are responsible for their products and applications using TI components. To minimize the risks associated with Buyers' products and applications, Buyers should provide adequate design and operating safeguards.

TI does not warrant or represent that any license, either express or implied, is granted under any patent right, copyright, mask work right, or other intellectual property right relating to any combination, machine, or process in which TI components or services are used. Information published by TI regarding third-party products or services does not constitute a license to use such products or services or a warranty or endorsement thereof. Use of such information may require a license from a third party under the patents or other intellectual property of the third party, or a license from TI under the patents or other intellectual property of TI.

Reproduction of significant portions of TI information in TI data books or data sheets is permissible only if reproduction is without alteration and is accompanied by all associated warranties, conditions, limitations, and notices. TI is not responsible or liable for such altered documentation. Information of third parties may be subject to additional restrictions.

Resale of TI components or services with statements different from or beyond the parameters stated by TI for that component or service voids all express and any implied warranties for the associated TI component or service and is an unfair and deceptive business practice. TI is not responsible or liable for any such statements.

Buyer acknowledges and agrees that it is solely responsible for compliance with all legal, regulatory and safety-related requirements concerning its products, and any use of TI components in its applications, notwithstanding any applications-related information or support that may be provided by TI. Buyer represents and agrees that it has all the necessary expertise to create and implement safeguards which anticipate dangerous consequences of failures, monitor failures and their consequences, lessen the likelihood of failures that might cause harm and take appropriate remedial actions. Buyer will fully indemnify TI and its representatives against any damages arising out of the use of any TI components in safety-critical applications.

In some cases, TI components may be promoted specifically to facilitate safety-related applications. With such components, TI's goal is to help enable customers to design and create their own end-product solutions that meet applicable functional safety standards and requirements. Nonetheless, such components are subject to these terms.

No TI components are authorized for use in FDA Class III (or similar life-critical medical equipment) unless authorized officers of the parties have executed a special agreement specifically governing such use.

Only those TI components which TI has specifically designated as military grade or "enhanced plastic" are designed and intended for use in military/aerospace applications or environments. Buyer acknowledges and agrees that any military or aerospace use of TI components which have **not** been so designated is solely at the Buyer's risk, and that Buyer is solely responsible for compliance with all legal and regulatory requirements in connection with such use.

TI has specifically designated certain components as meeting ISO/TS16949 requirements, mainly for automotive use. In any case of use of non-designated products, TI will not be responsible for any failure to meet ISO/TS16949.

### Products

Audio	<a href="http://www.ti.com/audio">www.ti.com/audio</a>
Amplifiers	<a href="http://amplifier.ti.com">amplifier.ti.com</a>
Data Converters	<a href="http://dataconverter.ti.com">dataconverter.ti.com</a>
DLP® Products	<a href="http://www.dlp.com">www.dlp.com</a>
DSP	<a href="http://dsp.ti.com">dsp.ti.com</a>
Clocks and Timers	<a href="http://www.ti.com/clocks">www.ti.com/clocks</a>
Interface	<a href="http://interface.ti.com">interface.ti.com</a>
Logic	<a href="http://logic.ti.com">logic.ti.com</a>
Power Mgmt	<a href="http://power.ti.com">power.ti.com</a>
Microcontrollers	<a href="http://microcontroller.ti.com">microcontroller.ti.com</a>
RFID	<a href="http://www.ti-rfid.com">www.ti-rfid.com</a>
OMAP Applications Processors	<a href="http://www.ti.com/omap">www.ti.com/omap</a>
Wireless Connectivity	<a href="http://www.ti.com/wirelessconnectivity">www.ti.com/wirelessconnectivity</a>

### Applications

Automotive and Transportation	<a href="http://www.ti.com/automotive">www.ti.com/automotive</a>
Communications and Telecom	<a href="http://www.ti.com/communications">www.ti.com/communications</a>
Computers and Peripherals	<a href="http://www.ti.com/computers">www.ti.com/computers</a>
Consumer Electronics	<a href="http://www.ti.com/consumer-apps">www.ti.com/consumer-apps</a>
Energy and Lighting	<a href="http://www.ti.com/energy">www.ti.com/energy</a>
Industrial	<a href="http://www.ti.com/industrial">www.ti.com/industrial</a>
Medical	<a href="http://www.ti.com/medical">www.ti.com/medical</a>
Security	<a href="http://www.ti.com/security">www.ti.com/security</a>
Space, Avionics and Defense	<a href="http://www.ti.com/space-avionics-defense">www.ti.com/space-avionics-defense</a>
Video and Imaging	<a href="http://www.ti.com/video">www.ti.com/video</a>

### TI E2E Community

[e2e.ti.com](http://e2e.ti.com)