

10-A Synchronous Buck Converter with High-Current Gate Driver

The TPS51163EVM evaluation module (EVM), is a high efficiency single phase synchronous buck converter providing a fixed 1.2-V output at up to 10 A from a 12-V input bus. The EVM uses the TPS51163 synchronous buck controller with 600 kHz.

Contents

| | | |
|----|--|----|
| 1 | Introduction | 2 |
| 2 | Description | 2 |
| 3 | Typical Applications | 2 |
| 4 | Features..... | 2 |
| 5 | Electrical Performance Specifications..... | 3 |
| 6 | Schematic..... | 4 |
| 7 | Test Setup | 5 |
| 8 | Test Procedure..... | 7 |
| 9 | Performance Data and Typical Characteristic Curves | 9 |
| 10 | EVM Assembly Drawing and PCB layout | 13 |
| 11 | List of Materials..... | 16 |
| 12 | References | 16 |

List of Figures

| | | |
|----|---|----|
| 1 | TPS51163EVM Schematic Diagram | 4 |
| 2 | Tip and Barrel Measurement for V_{OUT} Ripple | 5 |
| 3 | TPS51163EVM Recommended Test Set Up | 6 |
| 4 | Efficiency..... | 9 |
| 5 | Load Regulation..... | 9 |
| 6 | Line Regulation | 9 |
| 7 | Loop Response Gain and Phase | 10 |
| 8 | Load Transient..... | 11 |
| 9 | Output Overcurrent Protection..... | 11 |
| 10 | Output Ripple | 11 |
| 11 | Switch Node Waveform | 11 |
| 12 | Enable Turn-On | 12 |
| 13 | Enable Turn Off..... | 12 |
| 14 | Top Layer Assembly Drawing (Top View) | 13 |
| 15 | Bottom Assembly Drawing (Bottom View) | 13 |
| 16 | Top Copper (Top View)..... | 14 |
| 17 | Internal Layer 1 | 14 |
| 18 | Internal Layer 2..... | 15 |
| 19 | Bottom Copper (Top View)..... | 15 |

1 Introduction

The TPS51163EVM evaluation module (EVM), is a highly-effective, single-phase synchronous buck controller providing a fixed 1.2-V output at up to 10 A from a 12-V input bus. The EVM uses the TPS51163 step-down buck controller.

2 Description

The TPS51163EVM is designed to use a regulated 12-V (8-V to 14-V) bus to produce a high current, regulated 1.2-V output at up to 10 A of the load current. The TPS51163EVM is designed to demonstrate the TPS51163 in a typical low-voltage application while providing a number of test points to evaluate the performance of the TPS51163.

3 Typical Applications

- Server and Desktop Computer Subsystem Power Supplies
- Distributed Power Supplies
- General DC-DC Converters

4 Features

The TPS51163EVM features include

- 10-A DC Steady State Current
- Support pre-bias output voltage start up
- 600-kHz Switching frequency
- JP1 for enable function
- Convenient test points for probing critical waveforms and loop response testing
- Four-layer PCB with 2-oz. copper and all components on the top layer

5 Electrical Performance Specifications

Table 1 gives the EVM performance specifications.

Table 1. Performance Specification Summary

| SPECIFICATION | | TEST CONDITIONS | MIN | TYP | MAX | UNITS |
|--------------------------------|-------------------------------|---|-----|--------|------|-------|
| INPUT CHARACTERISTICS | | | | | | |
| V_{IN} | Input voltage range | | 8 | 12 | 14 | V |
| $I_{IN(max)}$ | Maximum input current | $V_{IN} = 8\text{ V}, I_O = 10\text{ A}$ | | | 1.7 | A |
| I_{IN} | No load input current | $V_{IN} = 14\text{ V}, I_O = 0\text{ A}$ | | | 35 | mA |
| OUTPUT CHARACTERISTICS | | | | | | |
| V_{OUT} | Output voltage | | | 1.2 | | V |
| V_{REG} | Output voltage regulation | Line regulation | | | 0.1% | |
| | | Load regulation | | | 0.4% | |
| V_{RIPPLE} | Output voltage ripple | $V_{IN} = 12\text{ V}, I_O = 10\text{ A}$ | | | 20 | mVpp |
| | Output load current | | 0 | | 10 | A |
| | Output overcurrent threshold | | | 15 | | A |
| SYSTEMS CHARACTERISTICS | | | | | | |
| f_{SW} | Switching frequency | | | 600 | | kHz |
| η | Peak efficiency | $V_{IN} = 12\text{ V}, V_{OUT} = 1.2\text{ V}, I_O = 8\text{ A}$ | | 89.13% | | |
| η | Full load efficiency | $V_{IN} = 12\text{ V}, V_{OUT} = 1.2\text{ V}, I_O = 10\text{ A}$ | | 88.96% | | |
| T_A | Operating ambient temperature | | | 25 | | °C |

6 Schematic

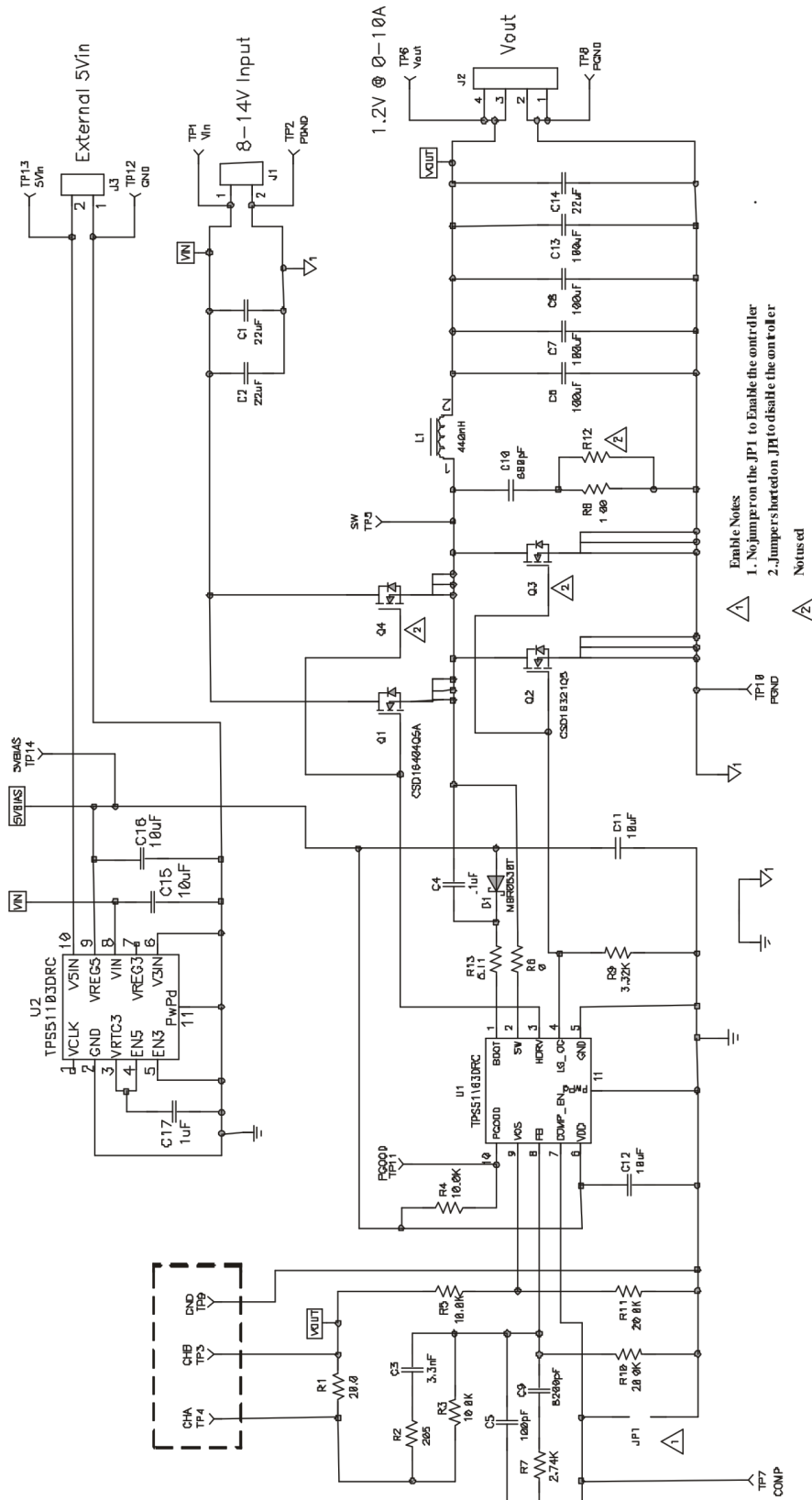

Enable Notes
 1. No jumper on the JPI to Enable the controller
 2. Jumpers shorted on JPI to disable the controller
 Not used

Figure 1. TPS51163EVM Schematic Diagram

7 Test Setup

7.1 Test Equipment

7.1.1 Voltage Source

The input voltage source V_{IN} should be a variable DC source between 0 V and 14 V, capable of supplying 10 Adc. Connect V_{IN} to J1 as shown in [Figure 3](#).

7.1.2 Multimeters

A voltmeter with a range between 0 V and 14 V should be used to measure V_{IN} at TP1(V_{IN}) and TP2(GND). A voltmeter with a range between 0 V and 5 V for V_{OUT} measurement at TP6(V_{OUT}) and TP8(GND). A current meter with a range between 0 A and 10 A (A1) as shown in [Figure 3](#) is used for input current measurements.

7.1.3 Output Load

The output load should be an electronic constant resistance mode load capable of between 0 Adc and 20 Adc at 1.2 V.

7.1.4 Oscilloscope

A digital or analog oscilloscope can be used to measure the output ripple. The oscilloscope should be set for 1-M Ω impedance, 20-MHz bandwidth, AC coupling, 1- μ s/division horizontal resolution, 20-mV/division vertical resolution. Test points TP6 and TP8 can be used to measure the output ripple voltage. Place the oscilloscope probe tip through TP6 and rest the ground barrel on TP8 as shown in [Figure 2](#). Using a leaded ground connection may induce additional noise due to the large ground loop.

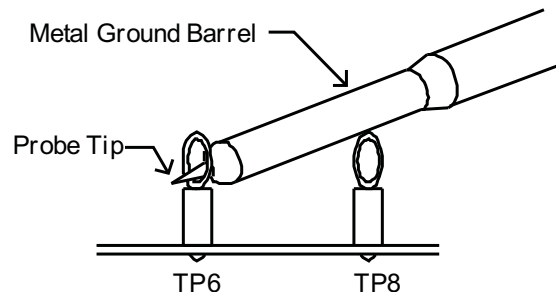

Figure 2. Tip and Barrel Measurement for V_{OUT} Ripple

7.1.5 Fan

Some of the components in this EVM may approach temperatures of 60°C during operating. A small fan capable of 200-400 LFM is recommended to reduce component temperatures while the EVM is operating. The EVM should not be probed while the fan is not running.

7.1.6 Recommended Wire Gauge

For V_{IN} to J1 (12-V input) the recommended wire size is 1 \times AWG #14 per input connection, with the total length of wire less than 4 feet (2 feet input, 2 feet return). For J2 to LOAD the minimum recommended wire size is 1 \times AWG #14, with the total length of wire less than 4 feet (2 feet output, 2 feet return).

7.2 Recommended Test Setup

Figure 3 is the recommended test set up to evaluate the TPS51163EVM. Working at an ESD workstation, make sure that any wrist straps, bootstraps or mats are connected referencing the user to earth ground before power is applied to the EVM.

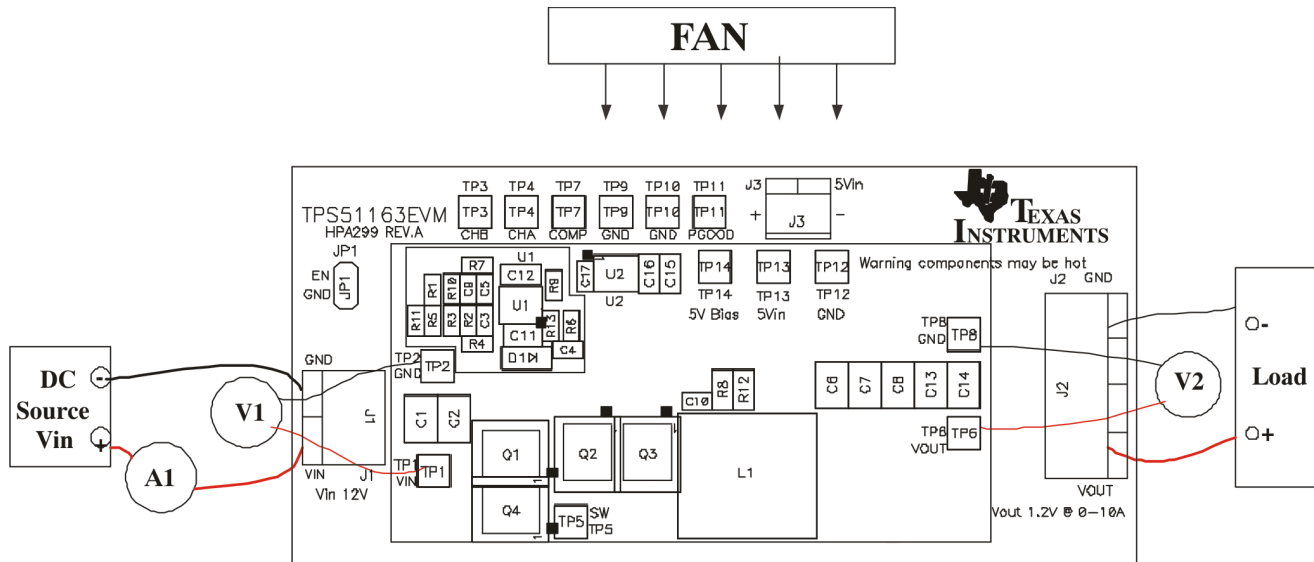

Figure 3. TPS51163EVM Recommended Test Set Up

7.2.1 Input Connections

1. Prior to connecting the DC input source V_{IN} , it is advisable to limit the source current from V_{IN} to 10 A maximum. Make sure V_{IN} is initially set to 0 V and connected as shown in Figure 3.
2. Connect a voltmeter V1 at TP1(V_{IN}) and TP2 (GND) to measure the input voltage.

7.2.2 Output Connections

1. Connect Load to J2 and set the load to constant resistance mode to sink 0 Adc before V_{IN} is applied.
2. Connect a voltmeter V2 at TP6 (V_{OUT}) and TP8 (GND) to measure the output voltage.

7.2.3 Other Connections

Place a fan as shown in Figure 3 and turn on, making sure air is flowing across the EVM.

8 Test Procedure

8.1 Line/Load Regulation and Efficiency Measurement Procedure

1. Ensure that the load is set to constant resistance mode and to sink 0 Adc.
2. Ensure that the jumper provided in the EVM to short on JP1 before V_{IN} is applied.
3. Increase V_{IN} from 0 V to 12 V, using V1 to measure input voltage.
4. Remove the jumper on JP1 to enable the controller.
5. Vary load from between 0 VAdc and 10Adc, V_{OUT} should remain in load regulation.
6. Vary V_{IN} from 8 V to 14 V. V_{OUT} should remain in line regulation.
7. Put the jumper on JP1 to disable the controller.
8. Decrease the load to 0 A.
9. Decrease V_{IN} to 0 V.

8.2 Control Loop Gain and Phase Measurement Procedure

TPS51163EVM contains a 20- Ω series resistor in the feedback loop for loop response analysis.

1. Set up EVM as described in the *Line/Load and Regulation and Efficiency Measurement Procedure* section and [Figure 3](#).
2. Connect isolation transformer to test points marked TP4 and TP3.
3. Connect input signal amplitude measurement probe (channel A) to TP4.
4. Connect output signal amplitude measurement probe (channel B) to TP3.
5. Connect ground lead of channel A and channel B to TP9 and TP10.
6. Inject approximately 40 mV or less signal through the isolation transformer.
7. Sweep the frequency from 100-Hz to 1MHz with a 10-Hz or lower post filter. The control loop gain and phase margin can be measured.
8. Disconnect isolation transformer from bode plot test points before making other measurements. (Signal injection into feedback may interfere with accuracy of other measurements.)

8.3 List of Test Points

Table 2. Test Point Functions

| TEST POINTS | NAME | DESCRIPTION |
|-------------|-----------|------------------------------|
| TP1 | V_{IN+} | 12-V input |
| TP2 | PGND | PGND for V_{IN} |
| TP3 | CHB | Input B for loop injection |
| TP4 | CHA | Input A for loop injection |
| TP5 | SW | Monitor switch node voltage |
| TP6 | V_{OUT} | V_{OUT} |
| TP7 | COMP | COMP/ Enable |
| TP8 | PGND | PGND for V_{OUT} |
| TP9 | GND | GND for loop measurement |
| TP10 | PGND | PGND |
| TP11 | PGOOD | Power Good |
| TP12 | GND | GND for External 5- V_{IN} |
| TP13 | 5Vin | External 5- V_{IN} |
| TP14 | 5Vbias | 5-V bias for VDD |

8.4 Equipment Shutown Procedure

1. Shut down load.
2. Shut down V_{IN} .
3. Shut down fan.

9 Performance Data and Typical Characteristic Curves

Figure 4 through Figure 13 present typical performance curves for the TPS51163EVM.

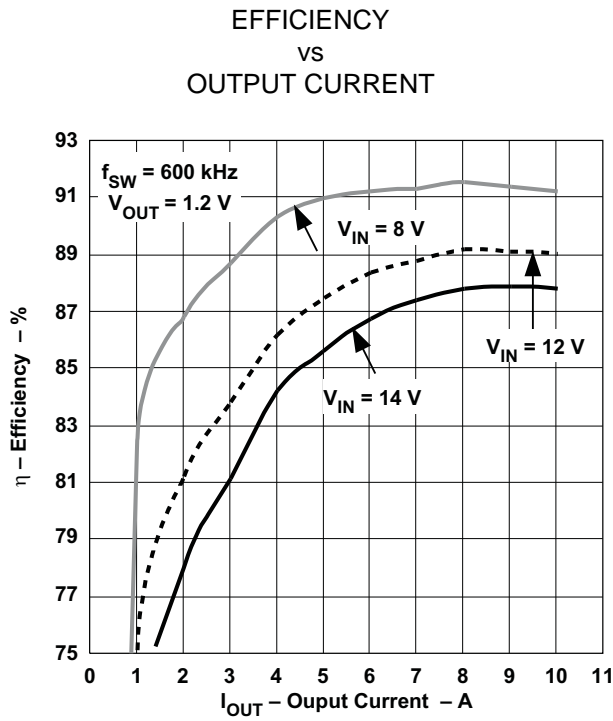

Figure 4. Efficiency

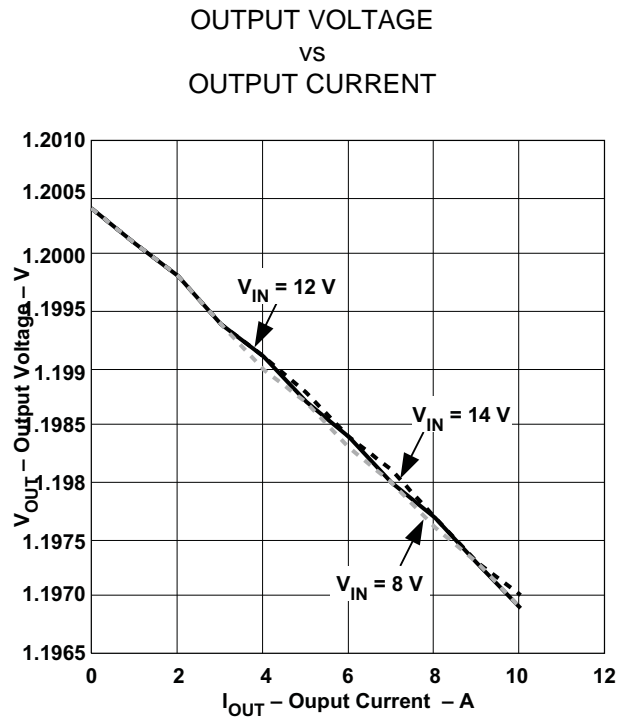

Figure 5. Load Regulation

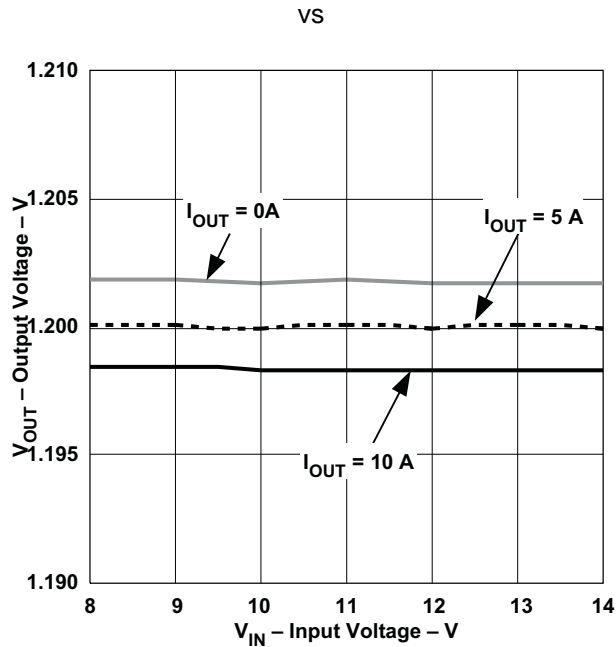

Figure 6. Line Regulation

In Figure 7, the following conditions apply:

- $V_{IN} = 12\text{ V}$
- $V_{OUT} = 1.2\text{ V}$
- $I_{LOAD} = 10\text{ A}$
- Crossover Frequency = 67.68 kHz
- Phase margin = 67.03°
- Gain margin = 35.83 dB

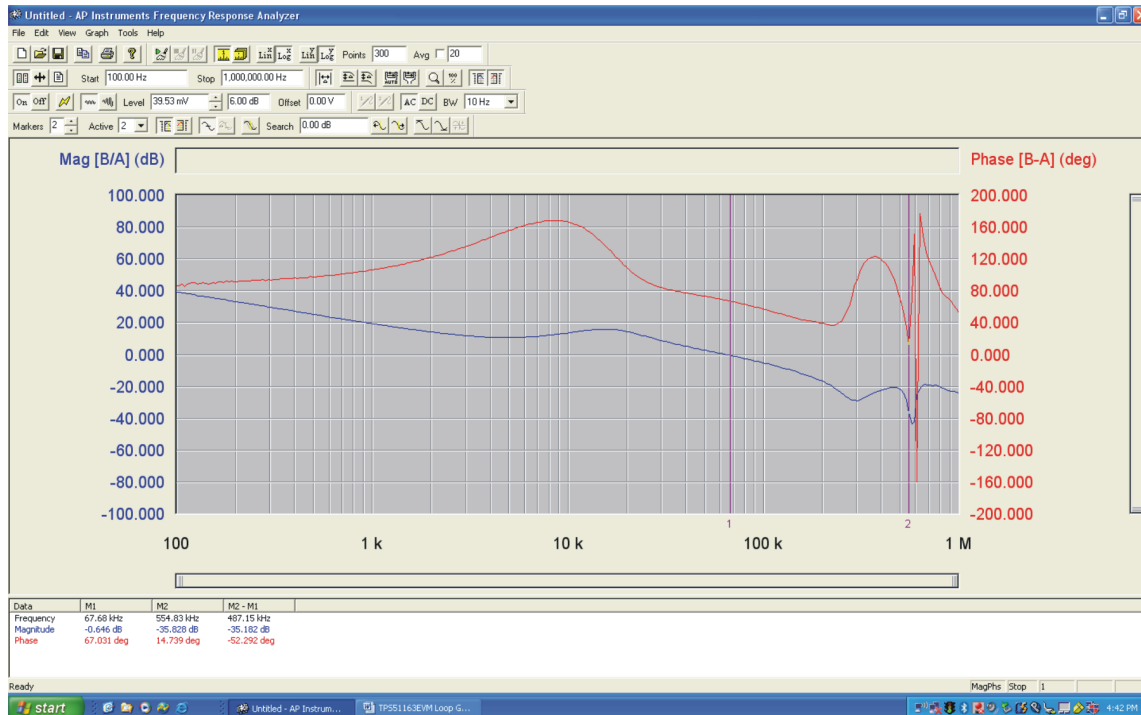

Figure 7. Loop Response Gain and Phase

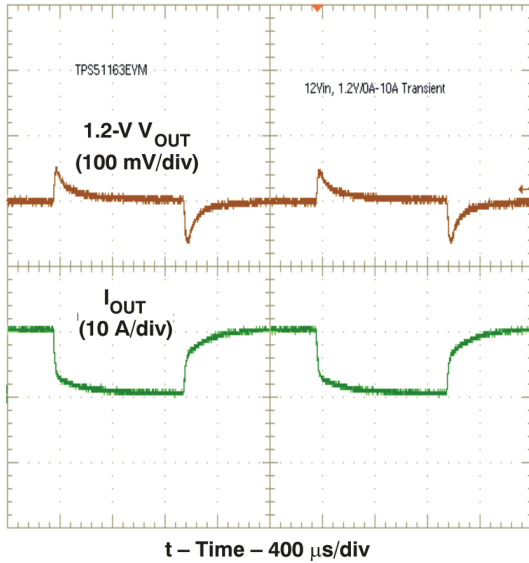

Figure 8. Load Transient

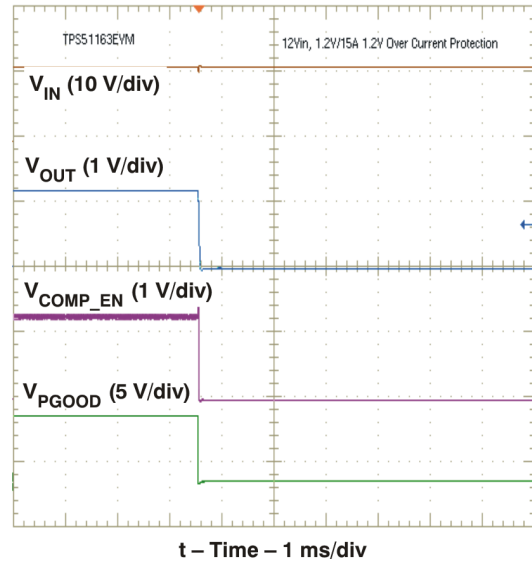

Figure 9. Output Overcurrent Protection

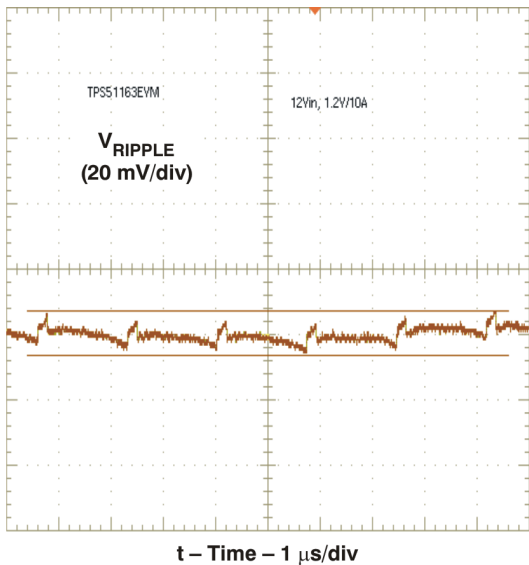

Figure 10. Output Ripple

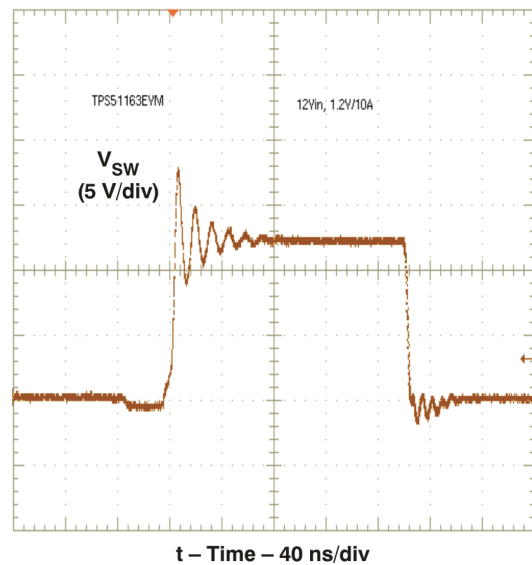

Figure 11. Switch Node Waveform

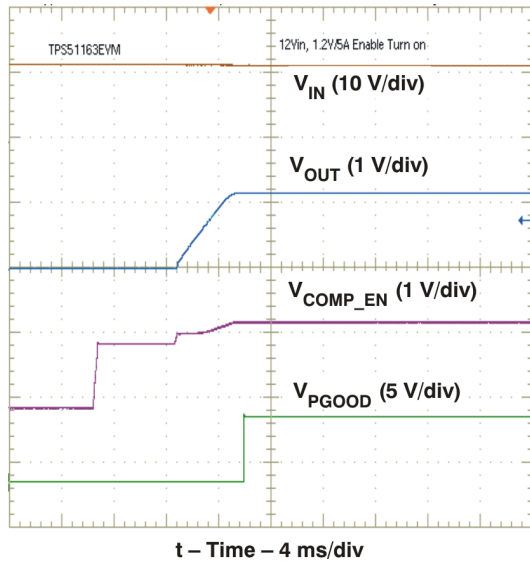

Figure 12. Enable Turn-On

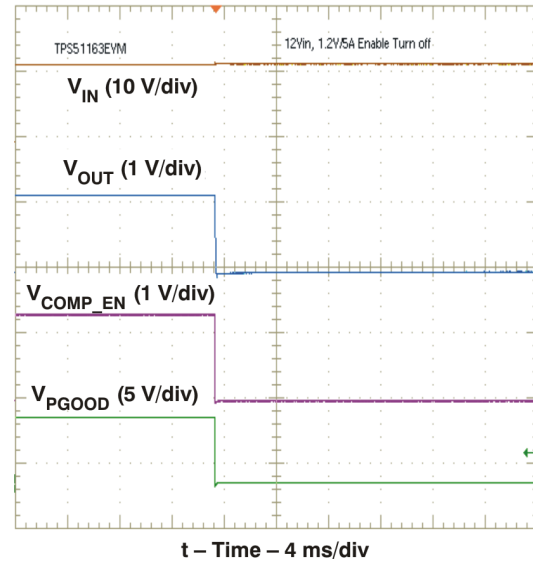

Figure 13. Enable Turn Off

10 EVM Assembly Drawing and PCB layout

Figure 14 through Figure 19 show the design of the TPS51163EVM printed circuit board. The EVM has been designed using 4 layers on a 2-oz. copper circuit board.

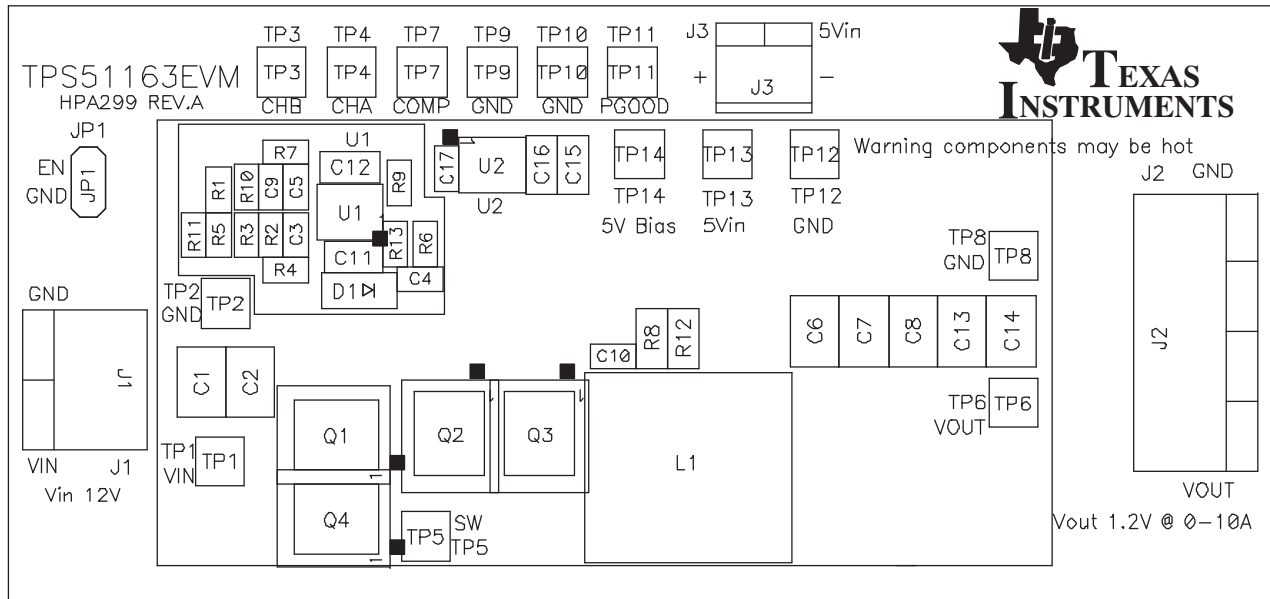

Figure 14. Top Layer Assembly Drawing (Top View)

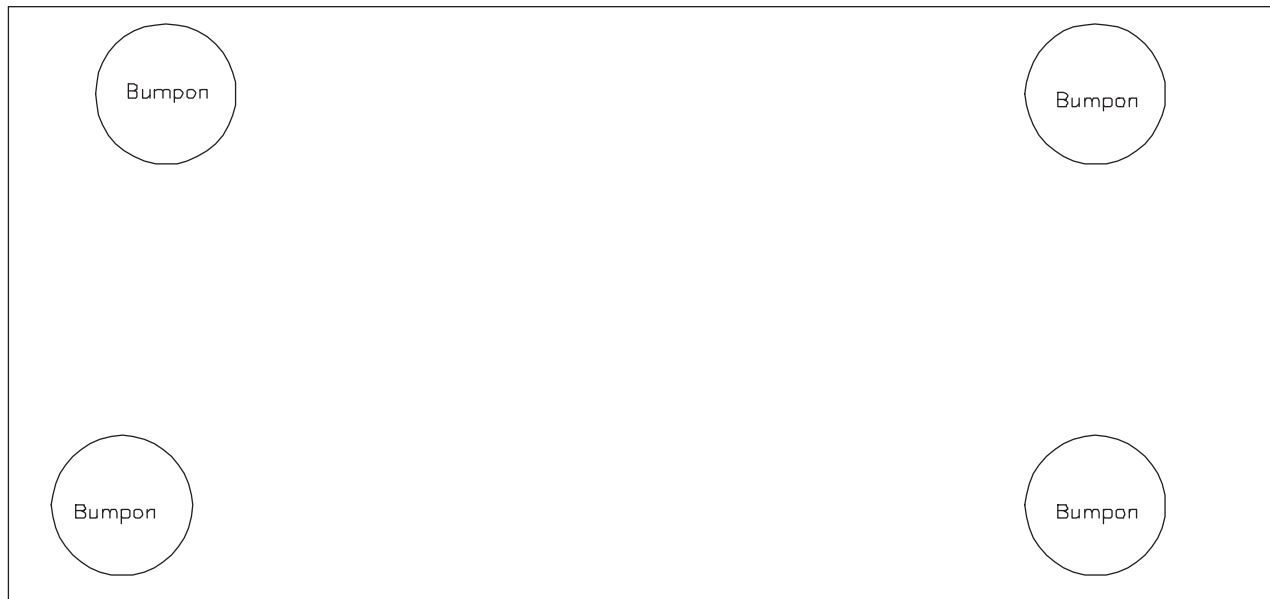

Figure 15. Bottom Assembly Drawing (Bottom View)

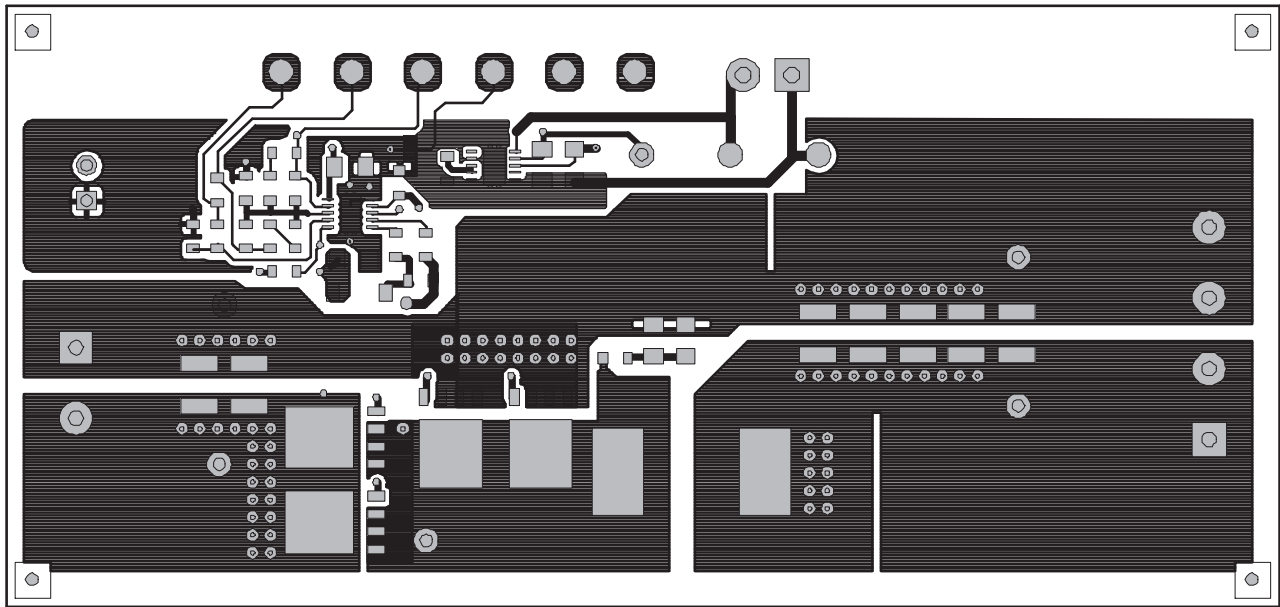

Figure 16. Top Copper (Top View)

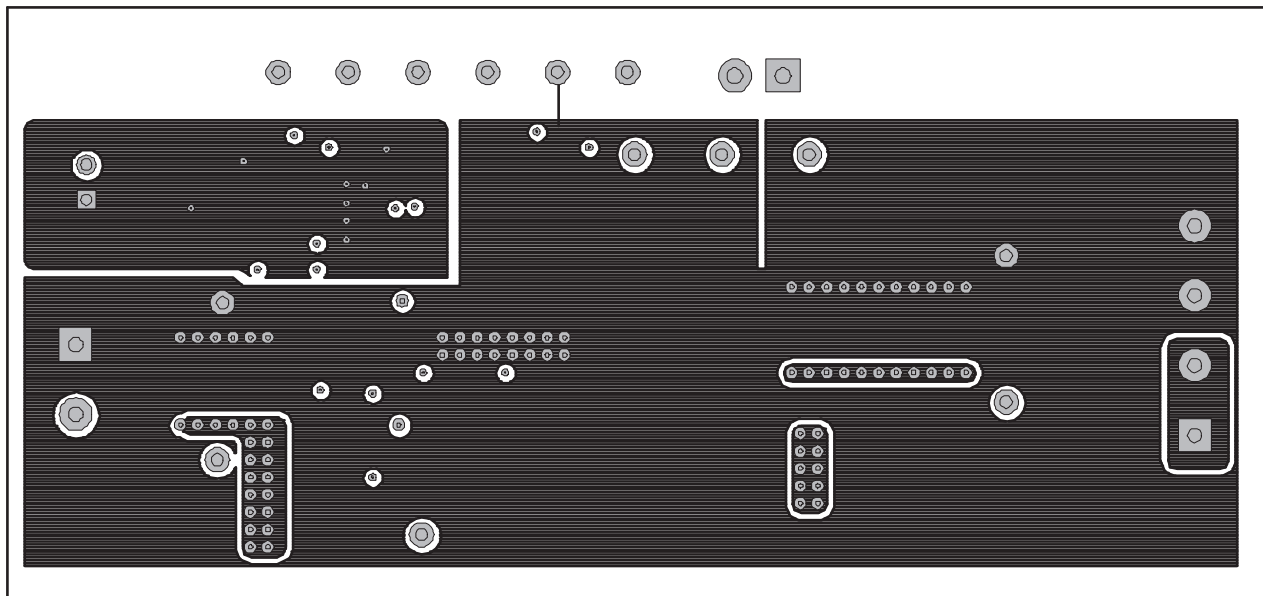

Figure 17. Internal Layer 1

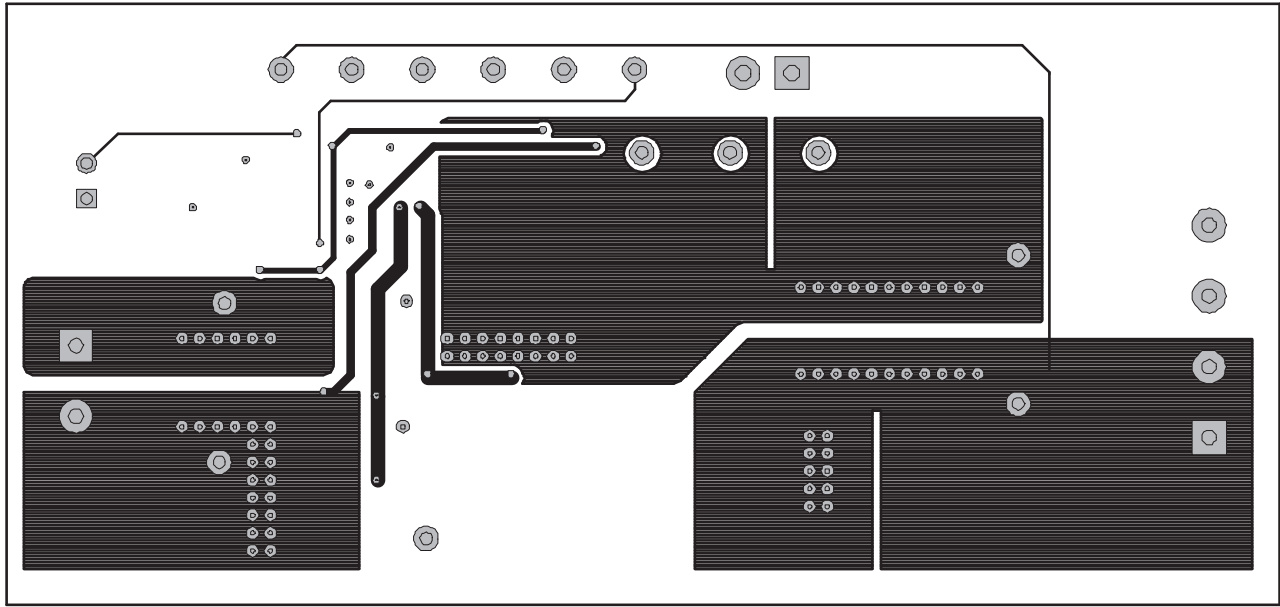

Figure 18. Internal Layer 2

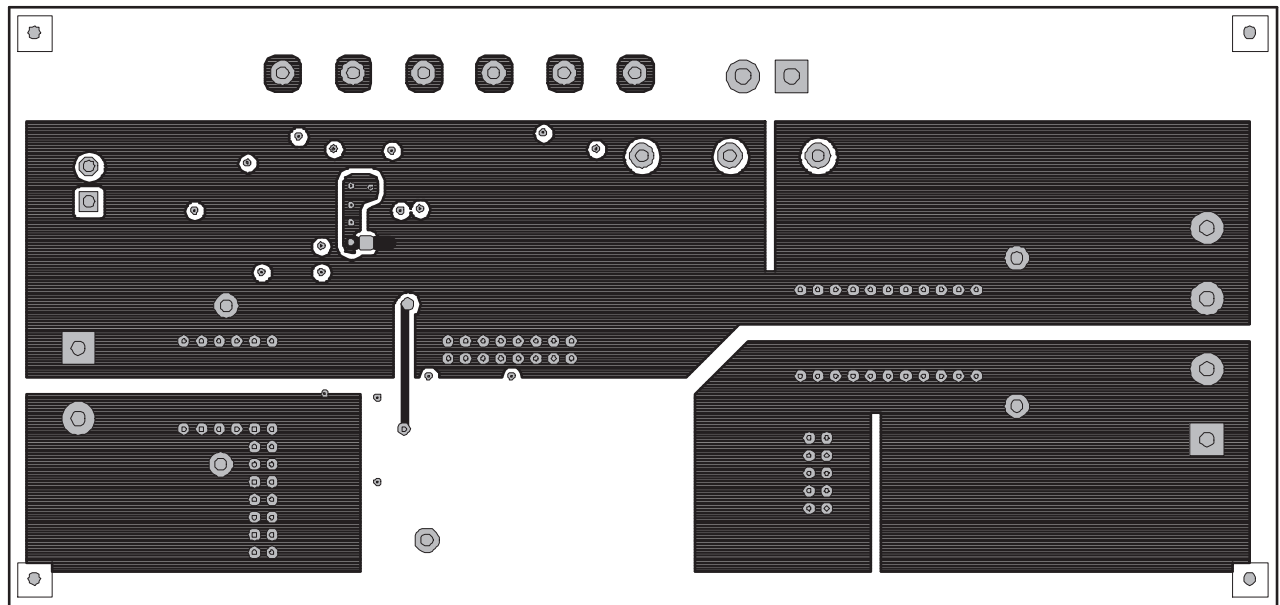

Figure 19. Bottom Copper (Top View)

11 List of Materials

List of materials for the TPS51163EVM.

Table 3. TPS51163EVM List of Materials

| REFERENCE DESIGNATOR | QTY | DESCRIPTION | MFR | PART NUMBER |
|----------------------|-----|---|----------------|--------------------|
| C1, C2, C14 | 3 | Capacitor, Ceramic, 22 μ F, 16 V, X5R, 20%, 1210 | MuRata | GRM32ER61C226KE20L |
| C10 | 1 | Capacitor, Ceramic, 680 pF, 25 V, X7R, 10%, 0603 | STD | STD |
| C11, C12, C15, C16 | 4 | Capacitor, Ceramic, 10 μ F, 16 V, X5R, 10%, 0805 | STD | STD |
| C17 | 1 | Capacitor, Ceramic, 1 μ F, 16 V, X7R, 10%, 0603 | STD | STD |
| C3 | 1 | Capacitor, Ceramic, 3300 pF, 25 V, X7R, 10%, 0603 | STD | STD |
| C4 | 1 | Capacitor, Ceramic, 0.1 μ F, 25 V, X7R, 10%, 0603 | STD | STD |
| C5 | 1 | Capacitor, Ceramic, 100 pF, 25 V, X7R, 10%, 0603 | STD | STD |
| C9 | 1 | Capacitor, Ceramic, 8200 pF, 25 V, X7R, 10%, 0603 | STD | STD |
| C6, C7, C8, C13 | 4 | Capacitor, Ceramic, 100 μ F, 6.3 V, X5R, 20%, 1210 | Murata | GRM32ER60J107ME20L |
| L1 | 1 | Inductor, Toroid, 440 nH, 30 A, 0.530" x 0.510" | E & E Magnetic | 831-02990F |
| | | | PULSE | PA0513-441NLT |
| R1 | 1 | Resistor, Chip, 20.0 Ω , 1/16 W, 1%, 0603 | STD | STD |
| R10, R11 | 2 | Resistor, Chip, 20.0 k Ω , 1/16 W, 1%, 0603 | STD | STD |
| R2 | 1 | Resistor, Chip, 205 Ω , 1/16 W, 1%, 0603 | STD | STD |
| R13 | 1 | Resistor, Chip, 5.11 Ω , 1/16 W, 1%, 0603 | STD | STD |
| R3, R4, R5 | 3 | Resistor, Chip, 10.0 k Ω , 1/16 W, 1%, 0603 | STD | STD |
| R6 | 1 | Resistor, Chip, 0.00, 1/16 W, 1%, 0603 | STD | STD |
| R7 | 1 | Resistor, Chip, 2.74 k Ω , 1/16 W, 1%, 0603 | STD | STD |
| R8 | 1 | Resistor, Chip, 1.0 Ω , 1/8 W, 1%, 0805 | STD | STD |
| R9 | 1 | Resistor, Chip, 3.32 k Ω , 1/16 W, 1%, 0603 | STD | STD |
| D1 | 1 | Diode, Schottky, 0.5 A, 30 V | Onsemi | MBR0530T |
| Q1 | 1 | MOSFET, N-channel, 25 V, 20 A, 5.8 m Ω , TDSON-8 | Ciclon | CSD16404Q5A |
| Q2 | 1 | MOSFET, N-channel, 25 V, 30 A, 2.1 m Ω , TDSON-8 | Ciclon | CSD16321Q5 |
| U1 | 1 | IC, 4.5-V to 13.2-V synchronous buck controller, SON-10 | TI | TPS51163DRC |
| U2 | 1 | IC, integrated LDO with switchover circuit | TI | TPS51103DRC |

12 References

TPS51163DRC Datasheet, 4.5-V to 13.2-V Synchronous Buck Controller([SLUS864](#)).

TPS51103DRC Datasheet, Integrated LDO With Switchover Circuit ([SLUS808](#)).

EVALUATION BOARD/KIT IMPORTANT NOTICE

Texas Instruments (TI) provides the enclosed product(s) under the following conditions:

This evaluation board/kit is intended for use for **ENGINEERING DEVELOPMENT, DEMONSTRATION, OR EVALUATION PURPOSES ONLY** and is not considered by TI to be a finished end-product fit for general consumer use. Persons handling the product(s) must have electronics training and observe good engineering practice standards. As such, the goods being provided are not intended to be complete in terms of required design-, marketing-, and/or manufacturing-related protective considerations, including product safety and environmental measures typically found in end products that incorporate such semiconductor components or circuit boards. This evaluation board/kit does not fall within the scope of the European Union directives regarding electromagnetic compatibility, restricted substances (RoHS), recycling (WEEE), FCC, CE or UL, and therefore may not meet the technical requirements of these directives or other related directives.

Should this evaluation board/kit not meet the specifications indicated in the User's Guide, the board/kit may be returned within 30 days from the date of delivery for a full refund. **THE FOREGOING WARRANTY IS THE EXCLUSIVE WARRANTY MADE BY SELLER TO BUYER AND IS IN LIEU OF ALL OTHER WARRANTIES, EXPRESSED, IMPLIED, OR STATUTORY, INCLUDING ANY WARRANTY OF MERCHANTABILITY OR FITNESS FOR ANY PARTICULAR PURPOSE.**

The user assumes all responsibility and liability for proper and safe handling of the goods. Further, the user indemnifies TI from all claims arising from the handling or use of the goods. Due to the open construction of the product, it is the user's responsibility to take any and all appropriate precautions with regard to electrostatic discharge.

EXCEPT TO THE EXTENT OF THE INDEMNITY SET FORTH ABOVE, NEITHER PARTY SHALL BE LIABLE TO THE OTHER FOR ANY INDIRECT, SPECIAL, INCIDENTAL, OR CONSEQUENTIAL DAMAGES.

TI currently deals with a variety of customers for products, and therefore our arrangement with the user **is not exclusive.**

TI assumes **no liability for applications assistance, customer product design, software performance, or infringement of patents or services described herein.**

Please read the User's Guide and, specifically, the Warnings and Restrictions notice in the User's Guide prior to handling the product. This notice contains important safety information about temperatures and voltages. For additional information on TI's environmental and/or safety programs, please contact the TI application engineer or visit www.ti.com/esh.

No license is granted under any patent right or other intellectual property right of TI covering or relating to any machine, process, or combination in which such TI products or services might be or are used.

FCC Warning

This evaluation board/kit is intended for use for **ENGINEERING DEVELOPMENT, DEMONSTRATION, OR EVALUATION PURPOSES ONLY** and is not considered by TI to be a finished end-product fit for general consumer use. It generates, uses, and can radiate radio frequency energy and has not been tested for compliance with the limits of computing devices pursuant to part 15 of FCC rules, which are designed to provide reasonable protection against radio frequency interference. Operation of this equipment in other environments may cause interference with radio communications, in which case the user at his own expense will be required to take whatever measures may be required to correct this interference.

EVM WARNINGS AND RESTRICTIONS

It is important to operate this EVM within the input voltage range of 4.4 V to 16 V and the output voltage range of 2.3 V to 4.4 V.

Exceeding the specified input range may cause unexpected operation and/or irreversible damage to the EVM. If there are questions concerning the input range, please contact a TI field representative prior to connecting the input power.

Applying loads outside of the specified output range may result in unintended operation and/or possible permanent damage to the EVM. Please consult the EVM User's Guide prior to connecting any load to the EVM output. If there is uncertainty as to the load specification, please contact a TI field representative.

During normal operation, some circuit components may have case temperatures greater than 75°C. The EVM is designed to operate properly with certain components above 100°C as long as the input and output ranges are maintained. These components include but are not limited to linear regulators, switching transistors, pass transistors, and current sense resistors. These types of devices can be identified using the EVM schematic located in the EVM User's Guide. When placing measurement probes near these devices during operation, please be aware that these devices may be very warm to the touch.

Mailing Address: Texas Instruments, Post Office Box 655303, Dallas, Texas 75265
Copyright © 2009, Texas Instruments Incorporated

IMPORTANT NOTICE

Texas Instruments Incorporated and its subsidiaries (TI) reserve the right to make corrections, modifications, enhancements, improvements, and other changes to its products and services at any time and to discontinue any product or service without notice. Customers should obtain the latest relevant information before placing orders and should verify that such information is current and complete. All products are sold subject to TI's terms and conditions of sale supplied at the time of order acknowledgment.

TI warrants performance of its hardware products to the specifications applicable at the time of sale in accordance with TI's standard warranty. Testing and other quality control techniques are used to the extent TI deems necessary to support this warranty. Except where mandated by government requirements, testing of all parameters of each product is not necessarily performed.

TI assumes no liability for applications assistance or customer product design. Customers are responsible for their products and applications using TI components. To minimize the risks associated with customer products and applications, customers should provide adequate design and operating safeguards.

TI does not warrant or represent that any license, either express or implied, is granted under any TI patent right, copyright, mask work right, or other TI intellectual property right relating to any combination, machine, or process in which TI products or services are used. Information published by TI regarding third-party products or services does not constitute a license from TI to use such products or services or a warranty or endorsement thereof. Use of such information may require a license from a third party under the patents or other intellectual property of the third party, or a license from TI under the patents or other intellectual property of TI.

Reproduction of TI information in TI data books or data sheets is permissible only if reproduction is without alteration and is accompanied by all associated warranties, conditions, limitations, and notices. Reproduction of this information with alteration is an unfair and deceptive business practice. TI is not responsible or liable for such altered documentation. Information of third parties may be subject to additional restrictions.

Resale of TI products or services with statements different from or beyond the parameters stated by TI for that product or service voids all express and any implied warranties for the associated TI product or service and is an unfair and deceptive business practice. TI is not responsible or liable for any such statements.

TI products are not authorized for use in safety-critical applications (such as life support) where a failure of the TI product would reasonably be expected to cause severe personal injury or death, unless officers of the parties have executed an agreement specifically governing such use. Buyers represent that they have all necessary expertise in the safety and regulatory ramifications of their applications, and acknowledge and agree that they are solely responsible for all legal, regulatory and safety-related requirements concerning their products and any use of TI products in such safety-critical applications, notwithstanding any applications-related information or support that may be provided by TI. Further, Buyers must fully indemnify TI and its representatives against any damages arising out of the use of TI products in such safety-critical applications.

TI products are neither designed nor intended for use in military/aerospace applications or environments unless the TI products are specifically designated by TI as military-grade or "enhanced plastic." Only products designated by TI as military-grade meet military specifications. Buyers acknowledge and agree that any such use of TI products which TI has not designated as military-grade is solely at the Buyer's risk, and that they are solely responsible for compliance with all legal and regulatory requirements in connection with such use.

TI products are neither designed nor intended for use in automotive applications or environments unless the specific TI products are designated by TI as compliant with ISO/TS 16949 requirements. Buyers acknowledge and agree that, if they use any non-designated products in automotive applications, TI will not be responsible for any failure to meet such requirements.

Following are URLs where you can obtain information on other Texas Instruments products and application solutions:

Products

| | |
|-----------------------------|--|
| Amplifiers | amplifier.ti.com |
| Data Converters | dataconverter.ti.com |
| DLP® Products | www.dlp.com |
| DSP | dsp.ti.com |
| Clocks and Timers | www.ti.com/clocks |
| Interface | interface.ti.com |
| Logic | logic.ti.com |
| Power Mgmt | power.ti.com |
| Microcontrollers | microcontroller.ti.com |
| RFID | www.ti-rfid.com |
| RF/IF and ZigBee® Solutions | www.ti.com/lprf |

Applications

| | |
|--------------------|--|
| Audio | www.ti.com/audio |
| Automotive | www.ti.com/automotive |
| Broadband | www.ti.com/broadband |
| Digital Control | www.ti.com/digitalcontrol |
| Medical | www.ti.com/medical |
| Military | www.ti.com/military |
| Optical Networking | www.ti.com/opticalnetwork |
| Security | www.ti.com/security |
| Telephony | www.ti.com/telephony |
| Video & Imaging | www.ti.com/video |
| Wireless | www.ti.com/wireless |

Mailing Address: Texas Instruments, Post Office Box 655303, Dallas, Texas 75265
Copyright © 2009, Texas Instruments Incorporated