

TAS5412-Q1 Evaluation Module

The purpose of the TAS5412-Q1 evaluation module (EVM) is to demonstrate the capabilities of the TAS5412-Q1 device. Access for all the device features is available through the hardware and the software graphical user interface (GUI) supplied. This user's guide contains a description of the EVM and the GUI. Included are the EVM schematics, bill of materials, and the board layout.

Contents

1	Quick-Start Guide	1
2	EVM Description	4
3	TAS5412-Q1 EVM Schematics, Board Layouts, and Bill of Materials	8

List of Figures

1	EVM Connections	2
2	End Panel for Input and Output Connections	2
3	End Panel for I ² C Connections	3
4	Main Window	3
5	Wiring Harness for Power and Speaker Connections.....	4
6	TAS5412-Q1 EVM Schematic (Sheet 1 of 2)	8
7	TAS5412-Q1 EVM Schematic (Sheet 2 of 2)	8
8	TAS5412-Q1PHD Top Layer	9
9	TAS5412-Q1PHD Mid Layer Level 1	9
10	TAS5412-Q1PHD Mid Layer Level 2	10
11	TAS5412-Q1PHD Bottom Layer.....	10
12	TAS5412-Q1PHD Top Silkscreen Overlay.....	11
13	TAS5412-Q1PHD Bottom Silkscreen Overlay.....	11

List of Tables

1	Bill of Materials for TAS5412-Q1 PHD EVM.....	12
---	---	----

1 Quick-Start Guide

This section provides a guide to set up and power up the EVM without the details in its operation. For more detailed operation, read the complete guide.

1.1 Overview

The EVM consists of a single printed-circuit board (PCB) mounted inside a metal chassis for EMC testing. The EVM must have an external I²C controller board to function. The USB-to-I²C controller board connects to a personal computer (PC) through a USB cable. The EVM connects to the I²C controller through a supplied 6-pin DIN cable. The PC needs the graphical user interface (GUI) software to control the EVM. See [Figure 1](#) for the device connections.

Hardware provided in the EVM modules consists of the EVM, an I²C controller board, a USB cable, a 6-pin DIN cable, and speaker cables.

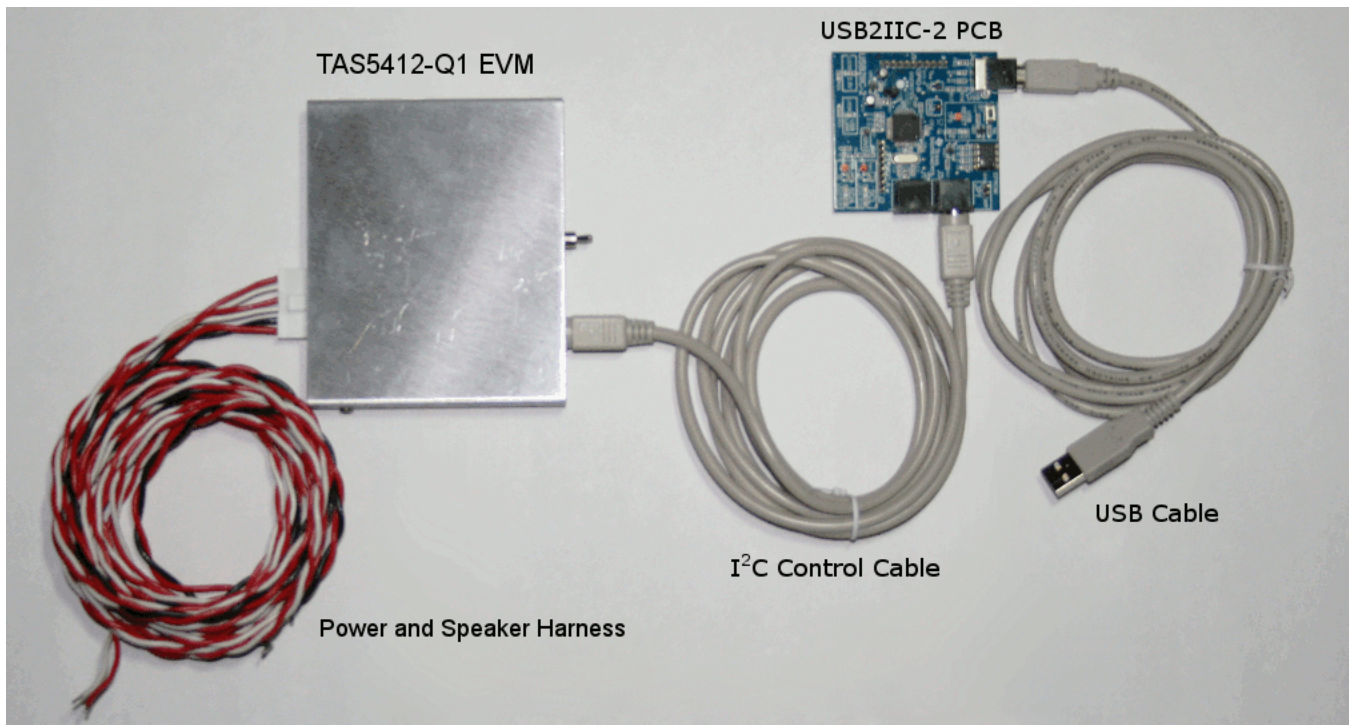

Figure 1. EVM Connections

1.2 Software Installation

The software is available on the TI Web site. Run the setup.exe program to install the GUI. For more details, read [Section 2.2, Graphical User Interface](#).

1.3 Connections

The connections are for an analog signal for the input, speaker loads, power, and I²C. Connect the audio inputs through the two RCA connectors. Connect the power and speakers using the six-pin connector.

Make the I²C connections using a 6-pin DIN connector. The provided cable and adapter PCB connect the EVM to the PC. The adapter PCB is an I²C-to-USB converter, which is an HID device which the PC automatically recognizes when connected. Therefore, there is no need for drivers.

The basic connections are: PVDD or power connects to the EVM through the supplied six-pin connector with the twisted red and black wires. The speakers or loads also connect through the same six-pin connector with the twisted red and white wires. The six-pin DIN connects to the I²C-to-USB adapter board. See [Figure 2](#) and [Figure 3](#) for EVM connection details.

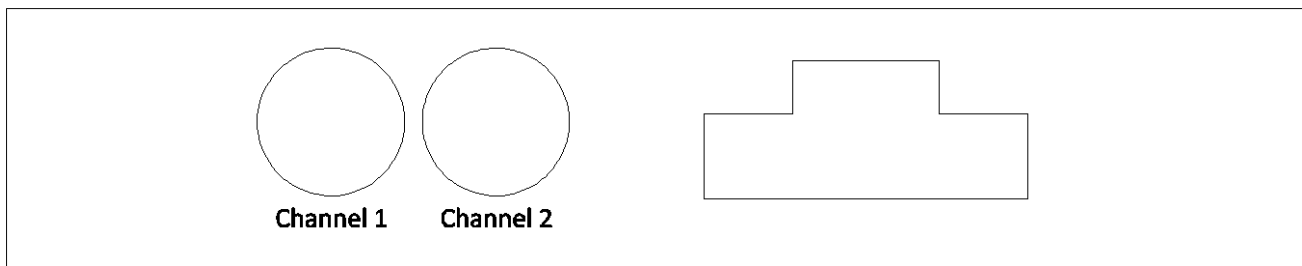

Figure 2. End Panel for Input and Output Connections

1.4 Initial Power Up

Before applying power, check to make sure the Standby control switch is in the Standby Off position, as shown in Figure 3. If the switch is in the Standby On position, then at power up the I²C LED indicator on the GUI is red (see Section 2.2.4.3, Connection Status Panel, for more details).

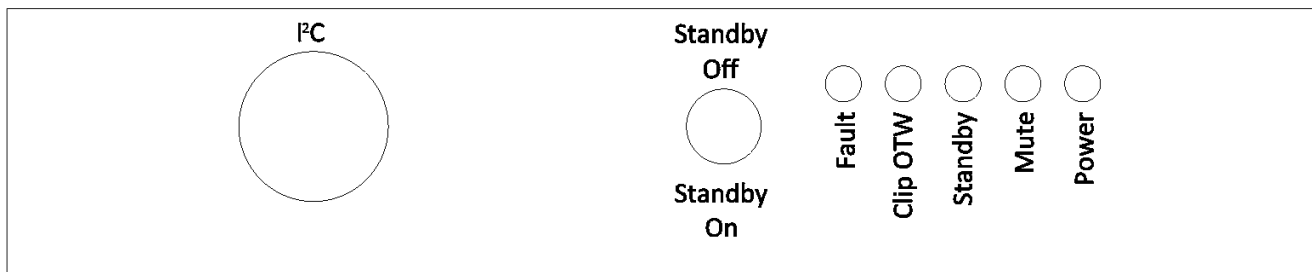

Figure 3. End Panel for I²C Connections

Apply power: the *Standby*, *Mute*, and *Power* LEDs should be on. The *Fault* LED may also be on, but not necessarily. This indicates that the unit is powered, and the TAS5412-Q1 is in standby mode and mute mode. The fault indicated is an undervoltage fault during power up. This is normal and is cleared by reading the I²C Register 0x00 (clicking the Read Faults button) twice. Reading the faults once clears the faults, and the second read is to ensure the clearing of all the faults.

1.5 Basic Graphical User Interface Controls

The default state for the device is *mute*. To *unmute*, click the Play All button at the top left of the window. To *mute*, click the Mute All button. Figure 4 shows the main EVM window.

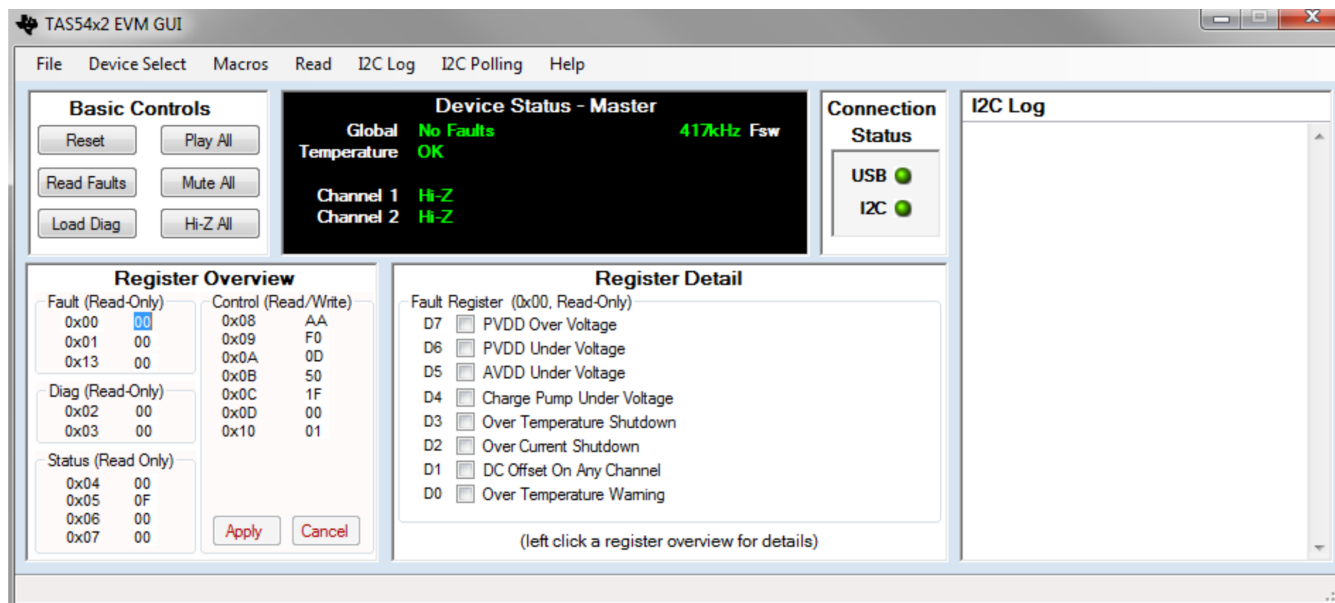

Figure 4. Main Window

2 EVM Description

2.1 Description of Input

2.1.1 Analog Inputs

Analog inputs are unbalanced, with connections to the EVM through the two RCA jacks. The unbalanced inputs have the shield of the RCA jacks connected to ground.

2.1.1.1 Power

The EVM requires one dc power connection. The connection is made through a six-pin supplied connector. The black wire is ground and the red wire connection is to PVDD, which can range from 6 to 24 Vdc. The power-supply voltage must exceed 7 Vdc for proper turnon, but can then dip to 6 Vdc and maintain operation.

2.1.2 Description of Outputs

2.1.2.1 Speaker and Power Connections

The six-pin connector on the EVM (and consequently the cables) can be divided into two groups: the power connector and the speaker channel connectors. The power connector consists of a pair of red and black twisted wires which correspond to the plus (+) output and minus (-) output, respectively. This pair of wires must connect to a power supply.

The speaker channel connectors consist of the remaining two pairs of red and white twisted wire. Each pair of red and white wires corresponds with a channel. The red wire corresponds to the plus (+) output and the white wire corresponds to the minus (-) output. These wires must terminate to a speaker load or resistive load.

See [Figure 1](#) for the location for the power connector, [Figure 5](#) for more details about the speaker cables, and [Figure 2](#) for the speaker-cable connections to the EVM.

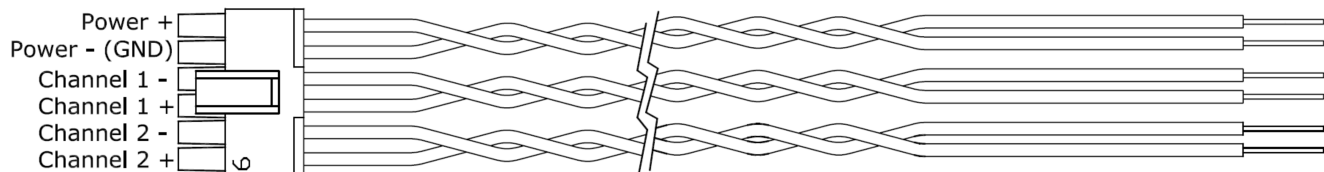

NOTE: Do not connect any of these outputs to ground. The TAS5412-Q1 has bridged outputs; connecting to ground triggers a fault.

Figure 5. Wiring Harness for Power and Speaker Connections

One can parallel the outputs can be paralleled by connecting the plus (+) of one channel to the plus (+) of the other channel. Connect the minus (-) connection of one channel and the minus (-) connection of the other channel together also. See the data sheet ([SLOS685](#)) for more details on parallel outputs (PBTL).

2.1.3 Controls

2.1.3.1 Standby

The Standby switch is located next to the six-pin DIN I²C input connector. The switch is in the *Standby On* position with the toggle positioned downward. In this position, the switch forces the TAS5412-Q1 into the standby mode. This is the same as a *Power-On Reset* (POR). POR shuts down the device, and I²C is not functional.

With the switch moved to the *Standby Off* position, the TAS5412-Q1 is in its default power-up mode. The I²C registers are at their default settings. The amplifier output is in Hi-Z mode.

2.1.4 Indicator Description

There are five LED indicators on the chassis next to the Standby switch. The LED farthest away from the Standby switch is for the 3.3-Vdc supply. The 3.3-V supply is for the LEDs and the *Standby* circuit. The other four LEDs indicate the four non-I²C output pins: FAULT, CLIP_OTW, STANDBY, and MUTE. The FAULT and CLIP_OTW signals also go to the six-pin DIN connector for the GUI. In normal play mode, these four LEDs should not light.

2.2 Graphical User Interface

2.2.1 Introduction

The TAS5412-Q1 GUI software design is for demonstrating the features of the TAS5412-Q1. The software is also able to assist the applications programmer in generating and saving the desired operating characteristics.

The TAS5412-Q1 GUI has a feature by which it can log the I²C data being sent to the device. This can be helpful to the programmer in understanding the I²C commands needed for proper function.

2.2.2 Software Installation

The GUI software is available on www.ti.com. Search for literature number SLOC296 and download the zip file. Run the setup.exe program on a personal computer (PC) with the Windows™ OS to install the GUI.

The software is currently supported on Windows XP and Windows 7. The GUI requires the Microsoft .NET environment. If it is not already installed on the PC, it can be downloaded from www.microsoft.com.

2.2.3 Hardware Installation

In the EVM package is a small PCB labeled USB2IIC-2. This is the USB-to-I²C converter used to communicate with the EVM. Connect the USB cable to the PC and the PCB. Connect one end of the six-pin cable to the socket labeled I²C on the converter PCB. Connect the other end to the six-pin socket on the EVM. The USB connection provides power for this card. The PC should automatically connect to the USB-connected PCB. See [Figure 1](#) for more details.

2.2.4 Using the GUI

2.2.4.1 The Main Window

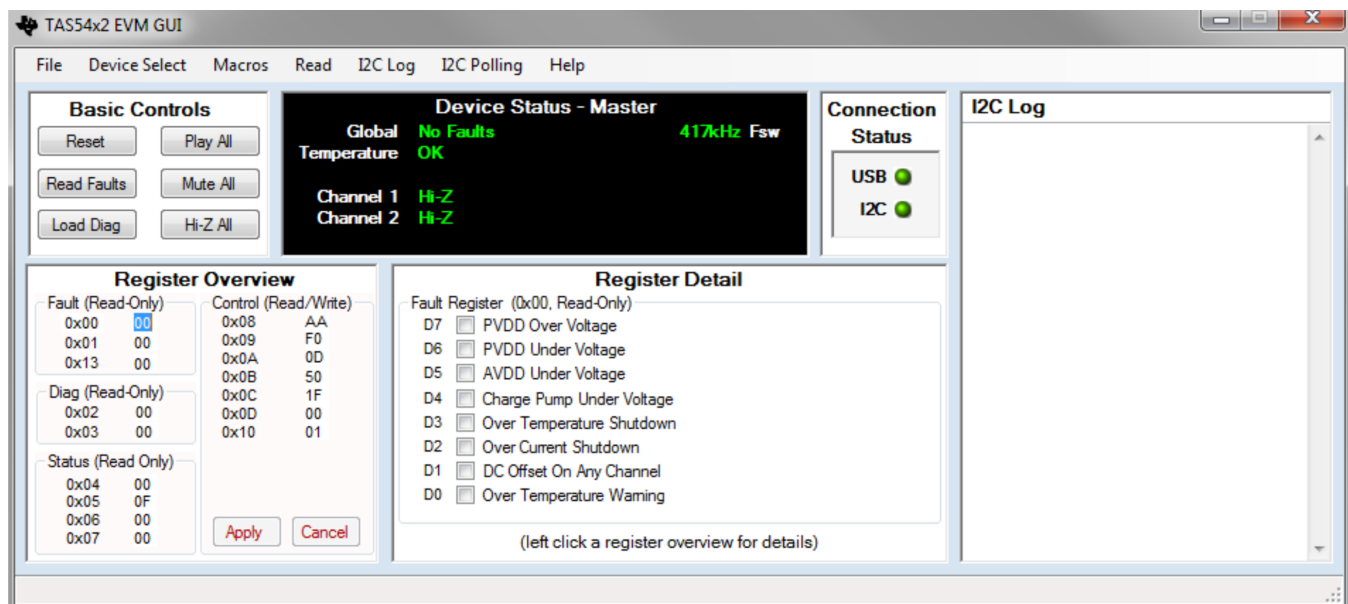

2.2.4.1.1 TAS5412-Q1 Control Panel

The control panel consists of six buttons that perform basic functions on all four channels.

Reset: This button sends a software reset to the device via I²C. Clicking the button is equivalent to sending 0x9F to register 0x0C. All the I²C defaults are restored.

Read Faults: This button reads the two fault registers 0x00 and 0x01 and reports the data to the Device Status panel.

Load Diag: This button runs a script to perform the built-in load diagnostics and reports any faults to the Device Status panel. The details are displayed for each channel.

Play All: This button uses I²C to write 0x09 to register 0x0C, which places all four channels into play mode.

Mute All: This button uses I²C to set all channels to mute mode by writing 0x10 to register 0x0C. All channels switch at 50% duty cycle, and no signal passes from the input to the output.

Hi-Z All: This button places all four channel outputs into a high-impedance state by writing 0x1F to register 0x0C. This action first places the device in mute, then invokes the Low-Low state, and lastly places the outputs in Hi-Z.

2.2.4.2 Device Status Panel

Device Panel Title: The title at the top of the Device Status panel shows the device to which the GUI is set to communicate. The four options are: Master, Slave1, Slave 2, and Slave 3. Use the *Device Select* menu item to changed this option.

Global: This provides fault feedback from the device. If a fault occurs, a red *Fault* is indicated. Read the fault detail in registers 0x00 and 0x01.

Temperature: This shows the temperature of the device. When the device is below 125°C, the color is green. At Level 1 OTW, the color is yellow. At Level 2 OTW, the color is orange. At Level 3 OTW, the color is red.

Channel 1 and Channel 2: These two items provide individual-channel output states: Hi-Z, Mute, Low-Low, and Play. The display shows the gain setting with the play indication.

Fsw: This item provides the switching frequency of the outputs.

2.2.4.3 Connection Status Panel

There are two LED indicators to provide connection status.

USB: The indicator is *Green* when a connection is good. This indicator is *Gray* when there is no USB connection to the USB2II2C PCB. The I²C LED is *off*.

I²C: A *Green* indicator shows that I²C communication is functioning properly. It is *Red* when there is no I²C connection, but a USB connection. If the LED is *off*, then there is no USB connection.

2.2.4.4 I²C Log Panel

All the I²C commands that are sent or received by the TAS5412-Q1 are shown in this panel except for I²C polling information. The displayed data can be copied to the clipboard for a programming aid.

This type of information can be controlled by the I²C Log menu item. An *R* indicates a value read from the device and a *W* indicates a value sent to the device. Valuable comments are also provided. Polled I²C reads are not shown to prevent over-running the panel with background reads. See [Section 2.2.4.7](#), Menu → I²C Log, for further details on each tab.

2.2.4.5 Register Overview Panel

This panel provides the hexadecimal (hex) data for each I²C register. One can directly change the hex data control registers here and send the settings to the device with the Apply button. Clicking the Cancel button clears any changes made to the data. Either changing the register's hex value directly or clicking on the register and changing the specific bit in the Register Detail panel updates the Register Detail panel (see [Section 2.2.4.6](#), Register Detail Panel).

2.2.4.6 Register Detail Panel

This panel provides a detailed view of each register. By clicking on a register in the Register Overview panel, the details of that register are shown. Each bit has its description and its value shown by the checkbox. A checkbox with a check mark indicates a logical 1 and an unchecked checkbox indicates a logical 0. One can change any bit by clicking on its checkbox. Clicking on the Apply button in the Register Overview panel sends the changes to the device.

2.2.4.7 Menu

File: In this menu, the Exit function is at the bottom of the drop-down menu.

Device Select: One can change the I²C device-select value in the menu. For the EVM, use the default value, which is *Master*.

Macros: This menu allows the use of macros. TI has not implemented the use of macros at this time.

Custom Macros: This will allow the users to create then save their own macros for later use.

Preloaded Macros: This menu item will provide a list of built-in macros to perform typical I²C routines.

Read: This menu contains the Read panel controls.

Fault Registers: When selected, the I²C log displays the values of the fault registers. Note that reading fault registers is different from reading faults.

Load Diagnostic Registers: When selected, the values of the load diagnostic registers are read and displayed in the I²C log.

Status Registers: When selected, the values of the status registers are read and displayed in the I²C log.

Control Registers: When selected, the values of the control registers are read and displayed in the I²C log.

All Registers: When selected, the values of all the registers are read and displayed in the I²C log.

Options: This menu contains the Options panel controls.

Crosstalk Compensation Enabled: Selection of this option optimizes crosstalk. With this option disabled, the standard operation optimizes PSRR.

180 Phase Difference: When selected, the channels switch at 180° phase difference.

Switching Frequency: When selected, one can set the switching frequency for AM avoidance to 357 kHz or 500 kHz.

All Channels Gain: Selecting this option allows changing the gain on all the channels to 12 dB, 20 dB, or 32 dB.

I²C Log: This menu contains the I²C Log panel controls.

Enabled: When selected, this menu option shows the I²C Log panel. Deselecting hides the I²C Log panel.

Show I²C Reads: When selected, this menu option shows the value read from the device. An *R* indicates read values.

Show I²C Writes: When selected, this menu option shows the values sent to the device. A *W* indicates written values.

Show Comments: When selected, this menu option shows the comments. Deselecting hides the comments.

Clear: The menu item clears the log data. The data is lost.

I²C Polling: This menu contains the I²C Polling panel controls.

Enabled: When selected, the I²C actively samples the status registers specifically. With I²C Polling disabled, there is **no** assurance that the register readings are valid.

Rate: When selected, one can change the poll rate (in ms). The default setting is 250 ms.

Help:

About: This provides the revision level of the software.

3 TAS5412-Q1 EVM Schematics, Board Layouts, and Bill of Materials

3.1 TAS5412-Q1PHD EVM Schematic

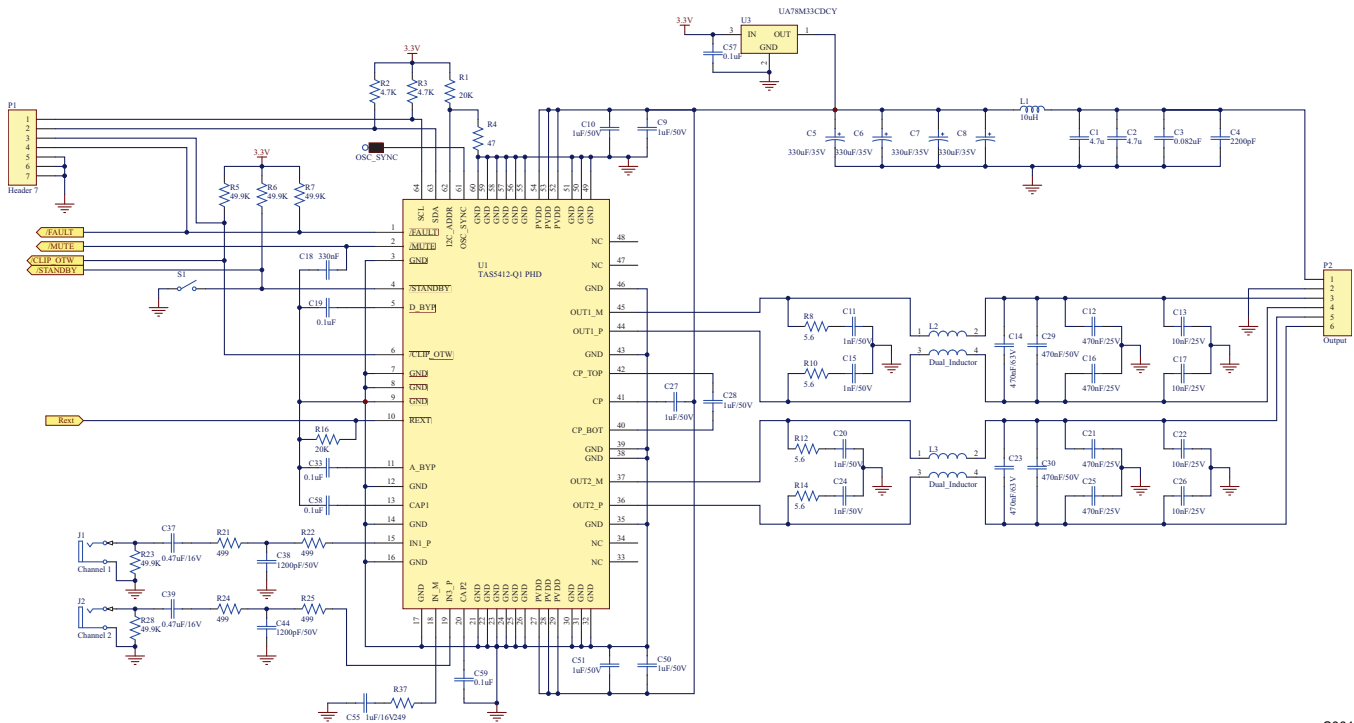

Figure 6. TAS5412-Q1 EVM Schematic (Sheet 1 of 2)

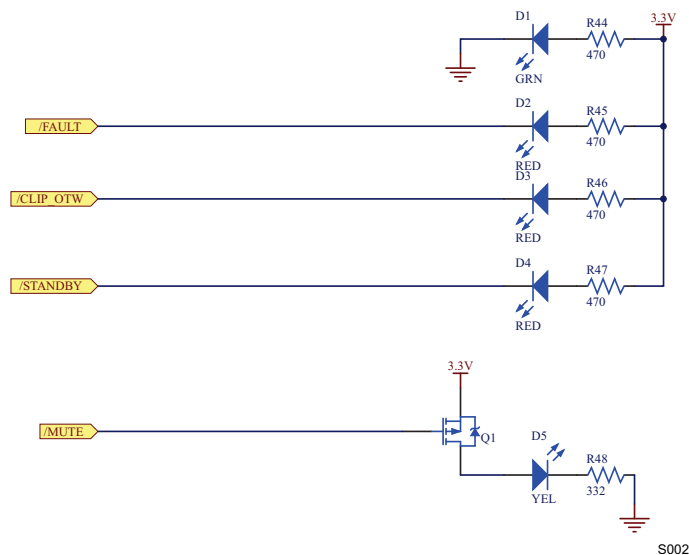

Figure 7. TAS5412-Q1 EVM Schematic (Sheet 2 of 2)

3.2 Board Layouts

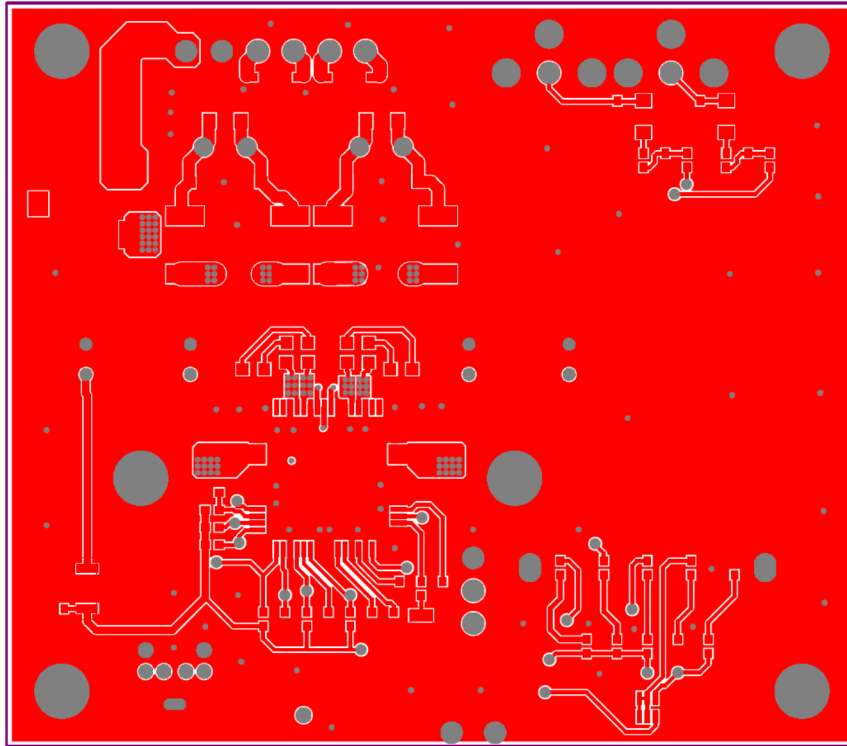

Figure 8. TAS5412-Q1PHD Top Layer

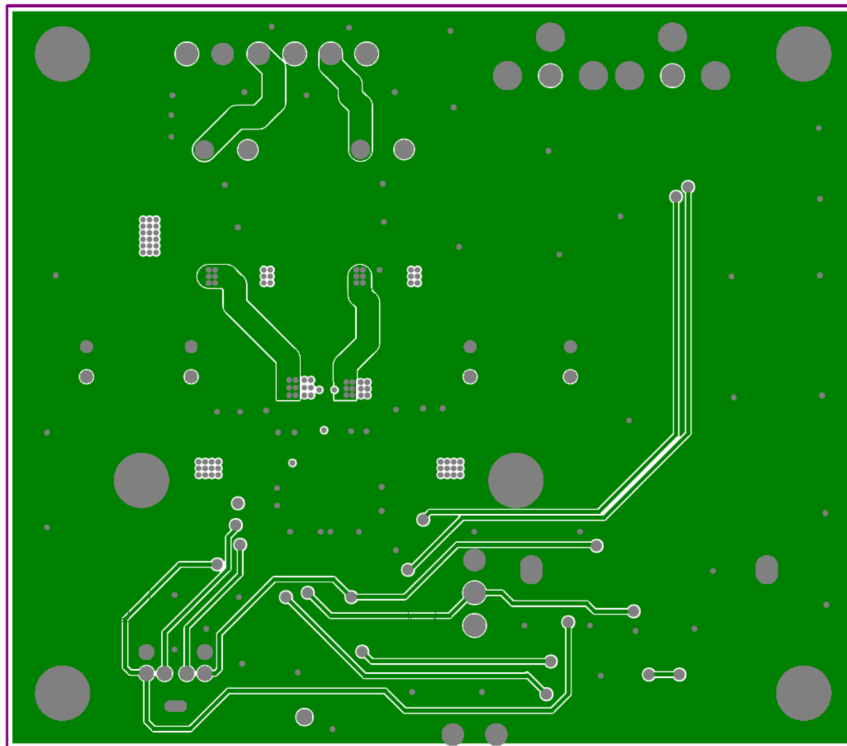

Figure 9. TAS5412-Q1PHD Mid Layer Level 1

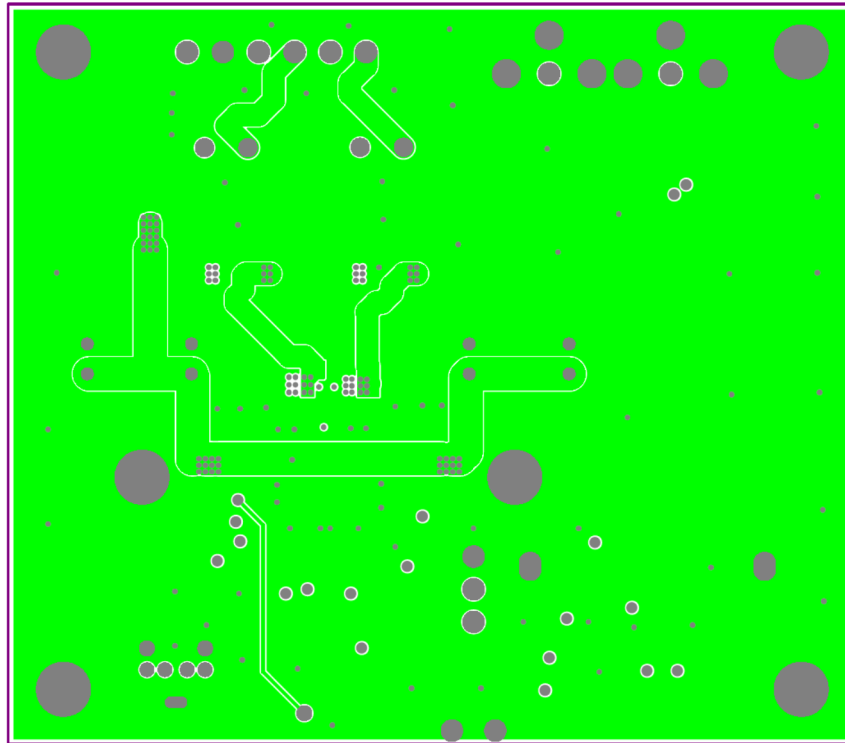

Figure 10. TAS5412-Q1PHD Mid Layer Level 2

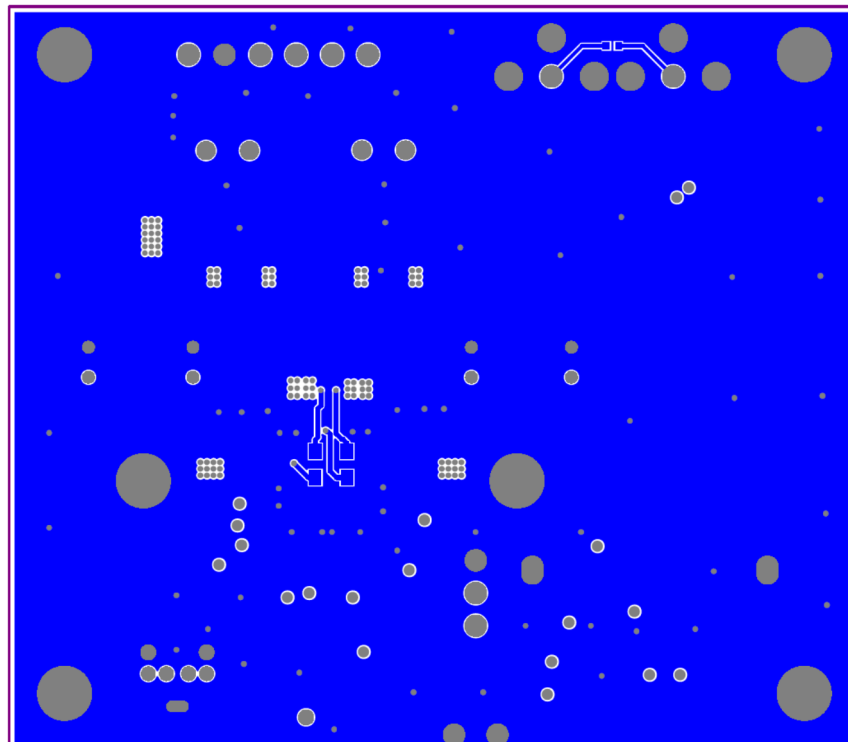

Figure 11. TAS5412-Q1PHD Bottom Layer

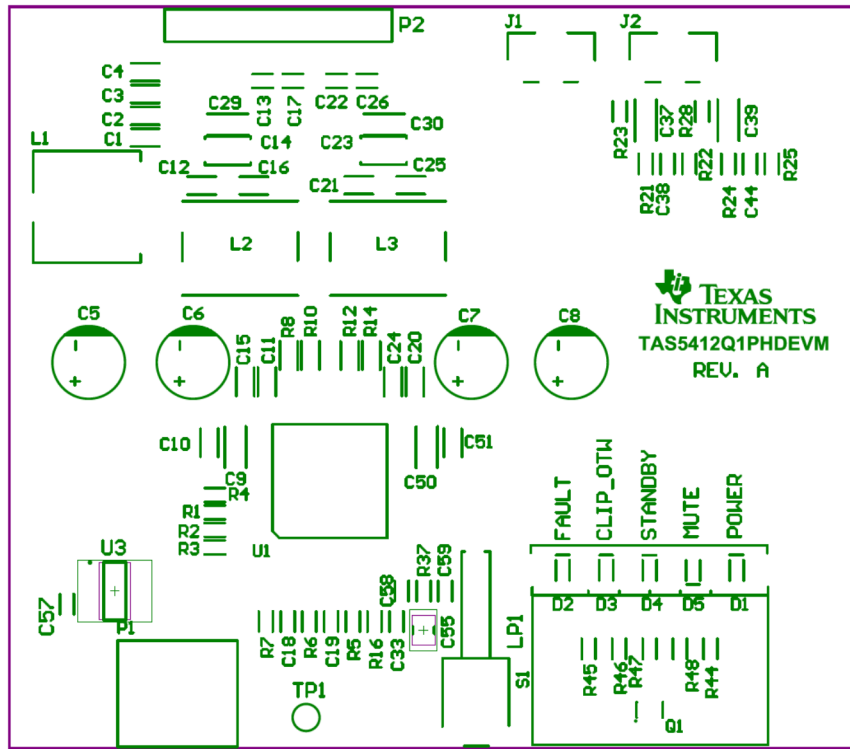

Figure 12. TAS5412-Q1PHD Top Silkscreen Overlay

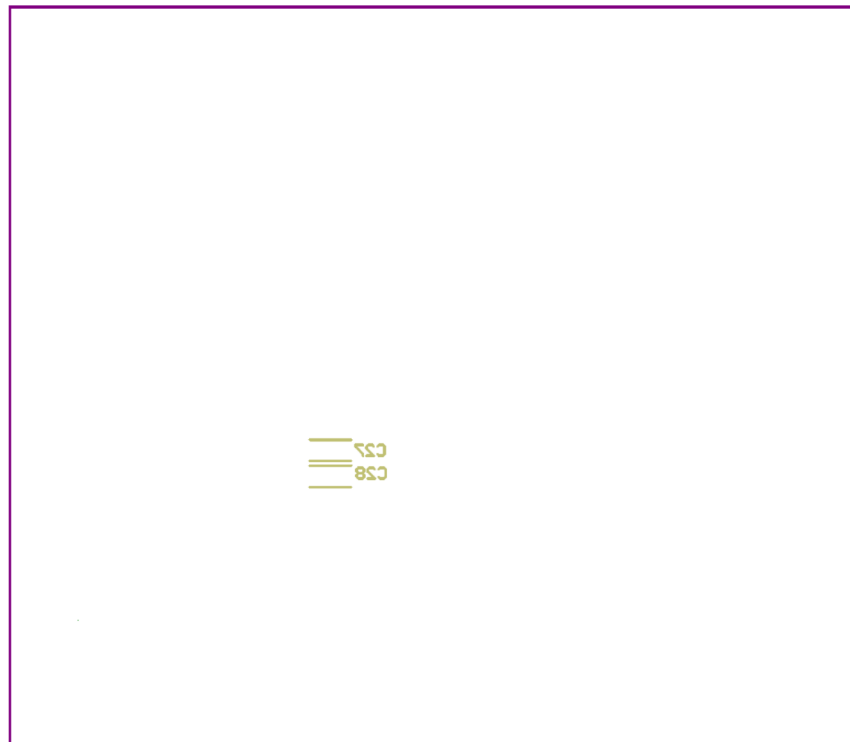

Figure 13. TAS5412-Q1PHD Bottom Silkscreen Overlay

3.3 Bill of Materials

Table 1. Bill of Materials for TAS5412-Q1 PHD EVM

Designator	Value	Description	Manufacturer, P/N	P/N (DIGIKEY)	QTY
C1, C2	4.7 μ F	Ceramic capacitor	TDK, C2012X5R1E475K	445-4116-1-ND	2
C3	0.082 μ F	Ceramic capacitor	Panasonic, ECJ-2YB1H823K	PCC1839CT-ND	1
C4	2200 pF	Ceramic capacitor	Panasonic, ECJ-2VB1H222K	PCC222BNCT-ND	1
C5, C6, C7, C8	330 μ F, 35 V	Electrolytic capacitor	Nichicon, UVR1V331MPD	493-1083-ND	4
C9, C10, C27, C28, C50, C51	1 μ F, 50 V	Ceramic capacitor	TDK,C3216X7R1H105K,	445-1423-1-ND	6
C11, C15, C20, C24	1nF, 50V	Ceramic capacitor	TDK, C3216X7R1H105K	445-1423-1-ND	4
C12, C16, C21, C25,	470 nF, 25 V	Ceramic capacitor	TDK,C2012X7R1E474K	445-1353-1-ND	4
C13, C17, C22, C26	10 nF, 25 V	Ceramic capacitor	Panasonic, ECJ-1VB1E103K	PCC1763CT-ND	4
C29, C30	470nF, 50V	Ceramic capacitor	TDK, CGA5L2X7R1H474K160AA	445-5700-1-ND	2
C14, C23	470 nF, 63 V	Film capacitor	EPCOS, B32529C474J, not populated	495-1110-ND	2
C18	220 nF	Ceramic capacitor	Kemet, C0603C224K4RACTU	399-5619-1-ND	1
C19, C33, C57	0.1 μ F	Ceramic capacitor	Panasonic, ECJ-1VB1C104K	PCC1762CT-ND	3
C20, C24, C29, C34	1 nF, 50 V	Ceramic capacitor	Panasonic, ECJ-2VB1H102K	PCC102BNCT-ND	4
C29, C30	470 nF, 50 V	Ceramic capacitor	TDK,CGA5L2X7R1H474K160AA	445-5700-1-ND	2
C37, C39	0.47 μ F, 16 V	Ceramic capacitor	Panasonic, ECP-U1C474MA5	PCF1130CT-ND	2
C38, C44	1200pF, 50 V	Ceramic capacitor	Panasonic, ECJ-1VB1H122K	PCC1773CT-ND	2
C55	1 μ F, 16 V	Film capacitor	Panasonic, ECP-U1C105MA5	PCF1132CT-ND	1
D1	GRN	Typical green GaAs LED	Lumex, SML-LX0603GW-TR	67-1549-1-ND	1
D2, D3, D4	RED	Typical red GaAs LED	Lumex, SML-LX0603SRW-TR	67-1551-1-ND	3
D5	YEL	Typical yellow GaAs LED	Lumex, SML-LX0603YW-TR	67-1550-1-ND	1
J1, J2	Input connector	RCA phono jack, right-angle, thru-hole, snap-in	CUI, RCJ-011	CP-1400-ND	2
L1	10 μ H	Inductor	Coilcraft, SER2918H-223KL		1
L2, L3	Dual_inductor	Dual inductor	Toko, HEAW		2
LP1	LIGHTPIPE 5 POS	Horizontal, LED Light pipe	Lumex, LPF-C051303S	67-1856-ND	1
P1	I ² C connector	Female Mini-DIN connector	CUI, MD-60S	CP-2460	1
P2	Output	6-Pin, Right Angle, connector	Samtech, IPBT-106-H1-T-S-RA		1
Q1	N MOS	N MOS FET	IR, IRLMS5703TRPBF	IRLMS5703PBFCT-ND	1
R1, R16	20 k Ω	RESISTOR	Panasonic, ERJ-3EKF2002V	P20.0KHCT-ND	2
R2, R3	4.7 k Ω	RESISTOR	Panasonic, ERJ-3EKF4701V	P4.70KHCT-ND	2
R4	47 Ω	RESISTOR	Panasonic, ERJ-3EKF47R0V	P47.0HCT-ND	1
R5, R6, R7, R28, R33	49.9 k Ω	RESISTOR	Panasonic,ERJ-3EKF4992V	P49.9KHCT-ND	5

Table 1. Bill of Materials for TAS5412-Q1 PHD EVM (continued)

Designator	Value	Description	Manufacturer, P/N	P/N (DIGIKEY)	QTY
R8, R10, R12, R14	5.6 Ω	RESISTOR	Susumu, RL1220S-5R6-F	RL12S5.6FCT-ND	4
R21, R22, R24, R25	499 Ω	RESISTOR	Panasonic, ERJ-3EKF4990V	P499HCT-ND	4
R37	249 Ω	RESISTOR	Panasonic, ERJ-3EKF2490V	P249HCT-ND	1
R44, R45, R46, R47	470 Ω	RESISTOR	Panasonic, ERJ-3GEYJ471V	P470GCT-ND	4
R48	332 Ω	RESISTOR	Panasonic, ERJ-3EKF3320V	P332HCT-ND	1
S1	S1	E-Switch, SPDT, right-angle	E-Switch, 100SP1T2B4M7RE	EG2364-ND	1
U1	TAS5412-Q1PHD	Amplifier, 2 channel	TI,, TAS5421TQ1PHDR		1
U3	UA78M33CDCY	Positive-Voltage Regulator	TI,, UA78M33CDCYR	296-13424-1-ND	1

IMPORTANT NOTICE

Texas Instruments Incorporated and its subsidiaries (TI) reserve the right to make corrections, enhancements, improvements and other changes to its semiconductor products and services per JESD46, latest issue, and to discontinue any product or service per JESD48, latest issue. Buyers should obtain the latest relevant information before placing orders and should verify that such information is current and complete. All semiconductor products (also referred to herein as "components") are sold subject to TI's terms and conditions of sale supplied at the time of order acknowledgment.

TI warrants performance of its components to the specifications applicable at the time of sale, in accordance with the warranty in TI's terms and conditions of sale of semiconductor products. Testing and other quality control techniques are used to the extent TI deems necessary to support this warranty. Except where mandated by applicable law, testing of all parameters of each component is not necessarily performed.

TI assumes no liability for applications assistance or the design of Buyers' products. Buyers are responsible for their products and applications using TI components. To minimize the risks associated with Buyers' products and applications, Buyers should provide adequate design and operating safeguards.

TI does not warrant or represent that any license, either express or implied, is granted under any patent right, copyright, mask work right, or other intellectual property right relating to any combination, machine, or process in which TI components or services are used. Information published by TI regarding third-party products or services does not constitute a license to use such products or services or a warranty or endorsement thereof. Use of such information may require a license from a third party under the patents or other intellectual property of the third party, or a license from TI under the patents or other intellectual property of TI.

Reproduction of significant portions of TI information in TI data books or data sheets is permissible only if reproduction is without alteration and is accompanied by all associated warranties, conditions, limitations, and notices. TI is not responsible or liable for such altered documentation. Information of third parties may be subject to additional restrictions.

Resale of TI components or services with statements different from or beyond the parameters stated by TI for that component or service voids all express and any implied warranties for the associated TI component or service and is an unfair and deceptive business practice. TI is not responsible or liable for any such statements.

Buyer acknowledges and agrees that it is solely responsible for compliance with all legal, regulatory and safety-related requirements concerning its products, and any use of TI components in its applications, notwithstanding any applications-related information or support that may be provided by TI. Buyer represents and agrees that it has all the necessary expertise to create and implement safeguards which anticipate dangerous consequences of failures, monitor failures and their consequences, lessen the likelihood of failures that might cause harm and take appropriate remedial actions. Buyer will fully indemnify TI and its representatives against any damages arising out of the use of any TI components in safety-critical applications.

In some cases, TI components may be promoted specifically to facilitate safety-related applications. With such components, TI's goal is to help enable customers to design and create their own end-product solutions that meet applicable functional safety standards and requirements. Nonetheless, such components are subject to these terms.

No TI components are authorized for use in FDA Class III (or similar life-critical medical equipment) unless authorized officers of the parties have executed a special agreement specifically governing such use.

Only those TI components which TI has specifically designated as military grade or "enhanced plastic" are designed and intended for use in military/aerospace applications or environments. Buyer acknowledges and agrees that any military or aerospace use of TI components which have **not** been so designated is solely at the Buyer's risk, and that Buyer is solely responsible for compliance with all legal and regulatory requirements in connection with such use.

TI has specifically designated certain components as meeting ISO/TS16949 requirements, mainly for automotive use. In any case of use of non-designated products, TI will not be responsible for any failure to meet ISO/TS16949.

Products

Audio	www.ti.com/audio
Amplifiers	amplifier.ti.com
Data Converters	dataconverter.ti.com
DLP® Products	www.dlp.com
DSP	dsp.ti.com
Clocks and Timers	www.ti.com/clocks
Interface	interface.ti.com
Logic	logic.ti.com
Power Mgmt	power.ti.com
Microcontrollers	microcontroller.ti.com
RFID	www.ti-rfid.com
OMAP Applications Processors	www.ti.com/omap
Wireless Connectivity	www.ti.com/wirelessconnectivity

Applications

Automotive and Transportation	www.ti.com/automotive
Communications and Telecom	www.ti.com/communications
Computers and Peripherals	www.ti.com/computers
Consumer Electronics	www.ti.com/consumer-apps
Energy and Lighting	www.ti.com/energy
Industrial	www.ti.com/industrial
Medical	www.ti.com/medical
Security	www.ti.com/security
Space, Avionics and Defense	www.ti.com/space-avionics-defense
Video and Imaging	www.ti.com/video

TI E2E Community

e2e.ti.com