

LMH5401EVM Evaluation Module (EVM)

The LMH5401EVM is an evaluation module for the single LMH5401 amplifier in a 14-lead high-performance RF package. This evaluation module is designed to quickly and easily demonstrate the functionality and versatility of the amplifier. The EVM is ready to connect to power, signal source, and test instruments through the use of onboard connectors. The EVM comes configured for easy connection with common 50-Ω laboratory equipment on its inputs and outputs. The amplifier is configured for single-ended input with gain of 12 dB (4 V/V). The board has differential outputs, one for each of the amplifier outputs. It can be easily configured for differential inputs, and single- or split-supply operation.

Contents

1	Features.....	2
2	EVM Specifications	2
3	Power Connections	3
	3.1 Split-Supply Operation	3
	3.2 Single-Supply Operation	3
4	Input and Output Connections	3
	4.1 CM (Output Common Mode Voltage) Input	3
	4.2 PD (Power Down) Input.....	3
	4.3 Single-Ended Inputs	3
	4.4 Differential Inputs	4
	4.5 Differential Outputs	4
	4.6 Single-Ended Outputs.....	4
5	LMH5401EVM Schematic, Layout, and Bill of Materials	5
	5.1 Schematic.....	5
	5.2 LMH5401EVM Layers	6
	5.3 Bill of Materials	9

List of Figures

1	LMH5401EVM Board.....	2
2	LMH5401EVM Schematic	5
3	LMH5401EVM Top Layer.....	6
4	Layer 2	6
5	Layer 3	7
6	Layer 4	7
7	Layer 5	8
8	Bottom Layer	8

List of Tables

1	LMH5401EVM Bill of Materials.....	9
---	-----------------------------------	---

1 Features

- Configured for split-supply operation and easily modified for single supply
- Single ended or differential input signals
- Fully differential output
- Designed for easy connection to standard 50-Ω input/output impedance test equipment
- Inputs and outputs include SMA connectors

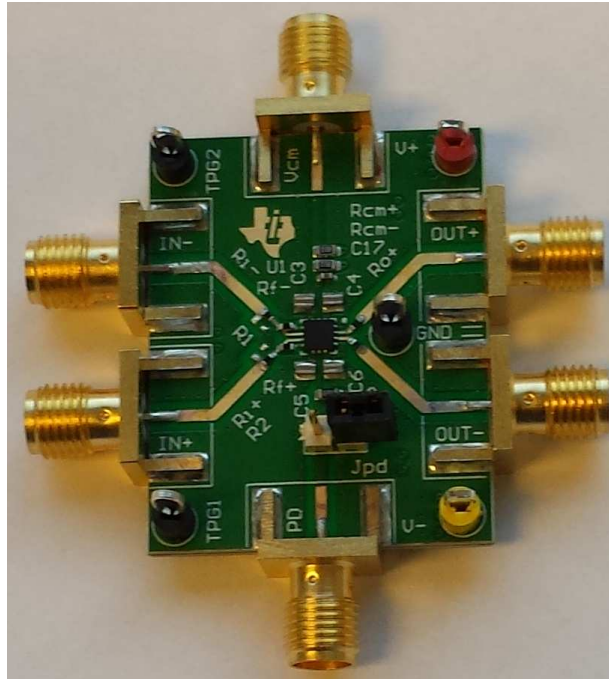

Figure 1. LMH5401EVM Board

2 EVM Specifications

PARAMETER		VALUE
V_S	Single-supply voltage range ($V_- = \text{ground}$)	3.15 V to 5.25 V
$V_{S\pm}$	Split-supply voltage range	$\pm 1.58 \text{ V}$ to $\pm 2.625 \text{ V}$
GND	Ground reference pins	($V_+ - 2 \text{ V}$) to V_-
PD	Power down (PD) input voltage	GND to V_{CC}
$I_{S\pm}$	Supply current	58 mA
I_{IN}	Input voltage	$V_{S\pm}, \text{Max}$
I_{OUT}	Output drive	$\pm 40 \text{ mA}$

3 Power Connections

The LMH5401EVM is equipped with test loops for easy connection of power. The positive supply input is red and is labeled V+. The negative supply input is yellow and is labeled V-. Ground is black and is labeled GND.

3.1 Split-Supply Operation

To operate as split supply, apply the positive supply voltage to V+, negative supply voltage to V-, and the ground reference from supply to GND. The supply voltages do not need to be symmetrical, provided that the total supply voltage is between 3.15 V and 5.25 V, any combination of positive and negative supply voltages is acceptable. This feature is often used when the output common mode voltage must be set to a particular value. For best performance, the power supply voltages should be symmetrical around the desired output common-mode voltage.

3.2 Single-Supply Operation

To operate as single supply, connect jumper V- to GND, and apply the positive supply voltage to V+. Inputs and outputs must be biased as in the LMH5401 datasheet ([SBOS710](#)) specifications for proper operation.

4 Input and Output Connections

The LMH5401EVM is equipped with SMA connectors for easy connection of signal generators and analysis equipment. As shipped, the EVM is configured for a gain of 12 dB, split supply, single-ended input and differential outputs each with 50-Ω termination. For best results, signals must be routed to and from the EVM with cables having 50-Ω characteristic impedance. The input connectors for single-ended input signals are IN+ and IN- which are symmetrical. The output connectors are OUT+ and OUT-. In addition to the signal cables a 50-Ω resistive termination is required for the unused input. See the LMH5401 datasheet for additional detail on configuring the device.

4.1 CM (Output Common Mode Voltage) Input

The LMH5401 device has an output common-mode control pin that sets the output common mode voltage. The evaluation board is configured with a resistive divider to set the output common mode voltage at the mid supply voltage. If a different output common-mode voltage is specified, the SMA connector can be used to connect an external voltage source. The valid voltage range for the CM pin is approximately $([V+] - 2\text{ V})$ to $([V-] + 2\text{ V})$. See the LMH5401 datasheet for performance curves that show how performance is impacted by an output common mode voltage that is not at the mid-supply voltage.

4.2 PD (Power Down) Input

The LMH5401 device has a power-down input pin that allows the amplifier to enter a low-power state when it does not need to be active. The LMH5401 PD pin is referenced to the GND pin. The threshold voltage is 1.1 V. Any voltage over 1.2 V above the ground reference pins will disable the amplifier. Any input below 0.9 V enables the amplifier. Because the PD pin is not referenced to either of the supply pins the same logic level can be used for the PD function regardless of the configuration of the supply voltages. The LMH5401EVM has a jumper (JPD) that allows the amplifier to be manually disabled. In order to facilitate driving the PD pin with a high-speed signal source, the resistor-capacitor combination (Rsd/C9) provides high frequency termination for signals from a 50-Ω pulse generator.

4.3 Single-Ended Inputs

The LMH5401 device was designed for use with 50-Ω single-ended inputs. Even though the board was designed for single-ended inputs, the board is fully symmetrical, so either input can be used. Connect a 50-Ω signal source to either IN+ or IN- and connect a 50-Ω SMA termination to the other input. This way both inputs have the same termination condition and the circuit is balanced. In the case where no SMA 50-Ω termination is available, soldering a 50-Ω resistor from the unused input signal trace to the ground plane is acceptable. A small section of the ground plane has no solder mask that can be used for this purpose.

4.4 Differential Inputs

Using the LMH5401 for differential inputs is possible, however the on chip resistors will need to be changed first. The LMH5401 device has an internal resistance of 25 Ω between the output and the FB connections. Once the desired value of the Rf resistors is determined reduce them by 25 Ohms. To impedance match a 100- Ω differential source, the R_{i-} and R₂ resistors both need to be 50 Ω . The desired gain will then determine the required value for R_{f+} and R_{f-}. The gain will be $A_v = (R_f + 25) / R_g$. As with other RF devices the final, system gain will depend on the source resistance and the load resistance.

4.5 Differential Outputs

The LMH5401EVM has two output SMA connectors that are designed to mate to 50- Ω test equipment. By connecting both outputs to 50- Ω test equipment, the output load is 100- Ω differential. With the on chip and on board matching resistors, the total load to the amplifier is 200 Ω . The matching resistors cause a 6-dB loss in voltage gain. The evaluation board has 40- Ω resistors on the board because there are 10- Ω output resistors on chip inside the device.

4.6 Single-Ended Outputs

Using an external balun to combine the two differential outputs creates a single-ended signal that can be interfaced to most 50- Ω test equipment. This is the method used by TI engineers to create the datasheet plots. To match the performance of the LMH5401 device, a very broadband balun must be selected. TI recommends the Marki B0100 or the PicoPulse Labs 5310A baluns.

5 LMH5401EVM Schematic, Layout, and Bill of Materials

This section contains the EVM schematic, PCB layouts, and the bill of materials (BOM).

5.1 Schematic

Figure 2 illustrates the LMH5401EVM schematic.

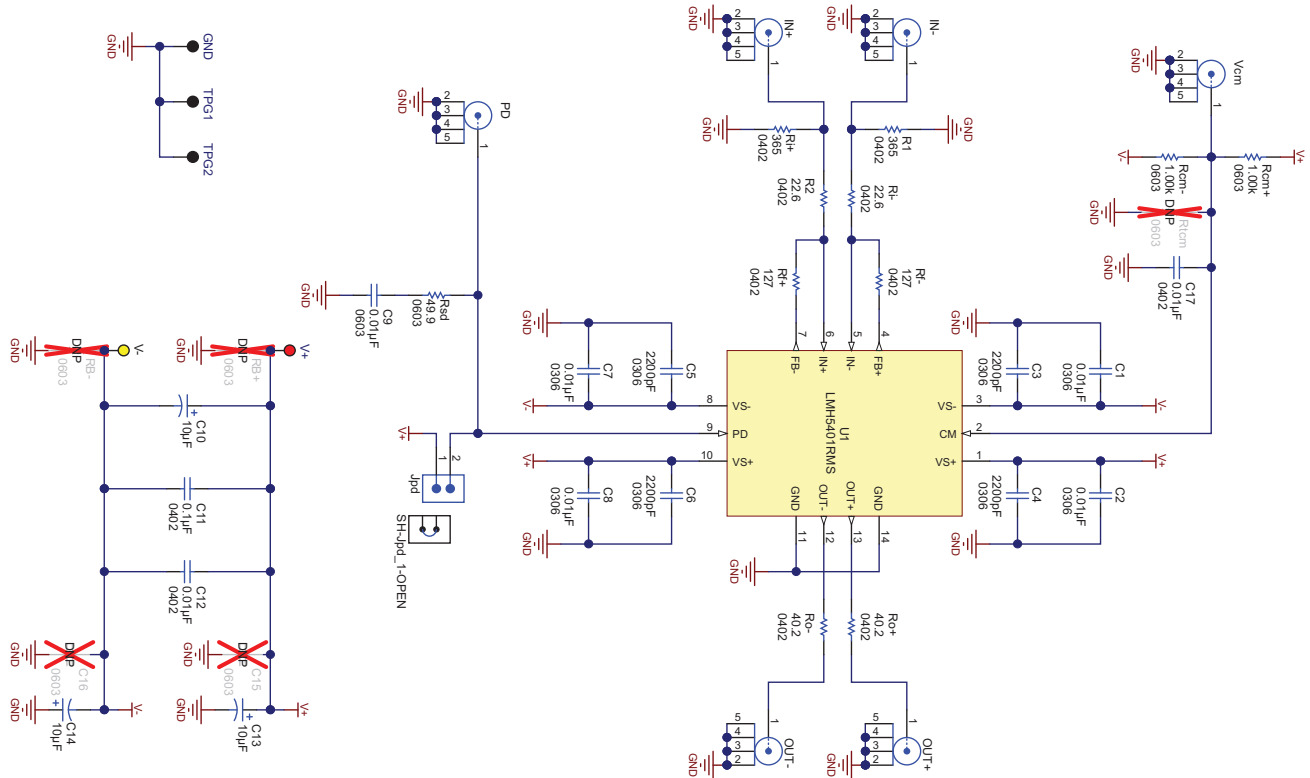

Figure 2. LMH5401EVM Schematic

5.2 LMH5401EVM Layers

Figure 3 through Figure 8 show the LMH5401EVM layers.

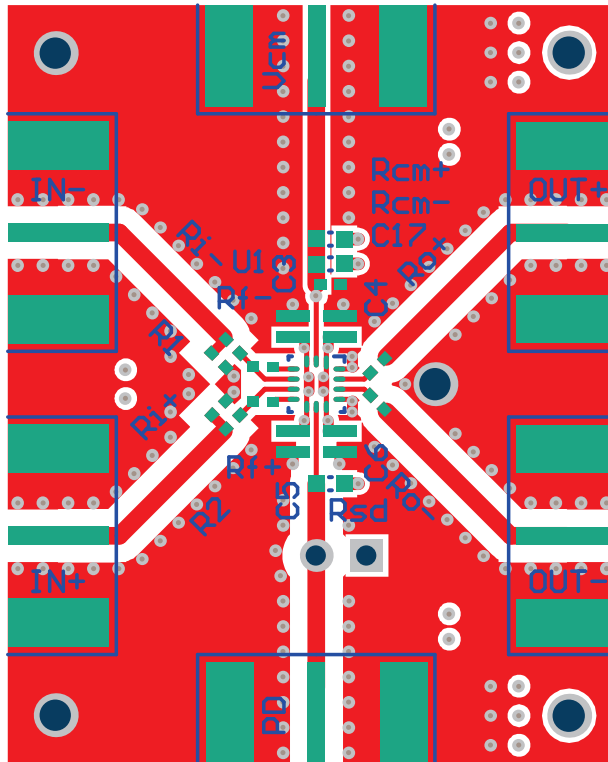

Figure 3. LMH5401EVM Top Layer

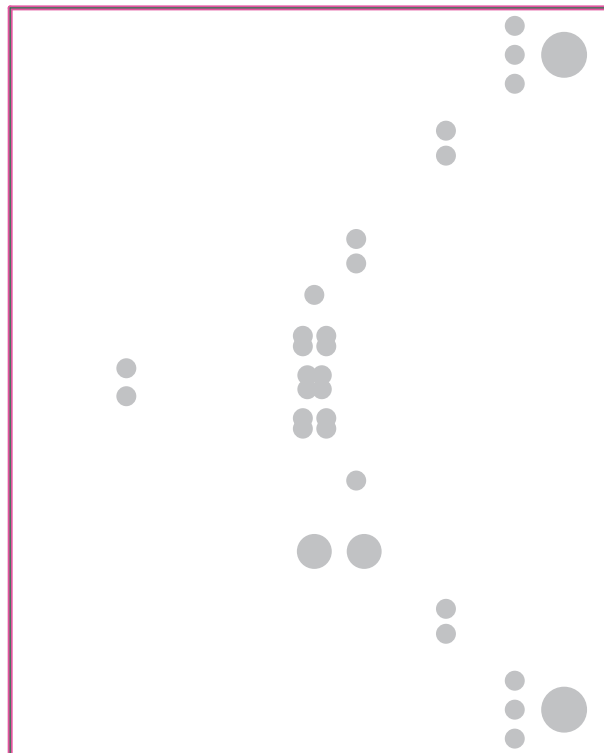

Figure 4. Layer 2

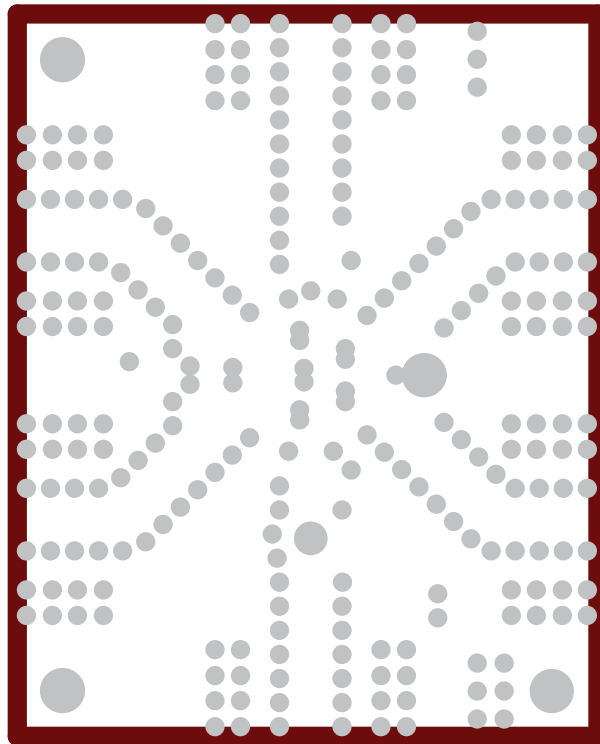

Figure 5. Layer 3

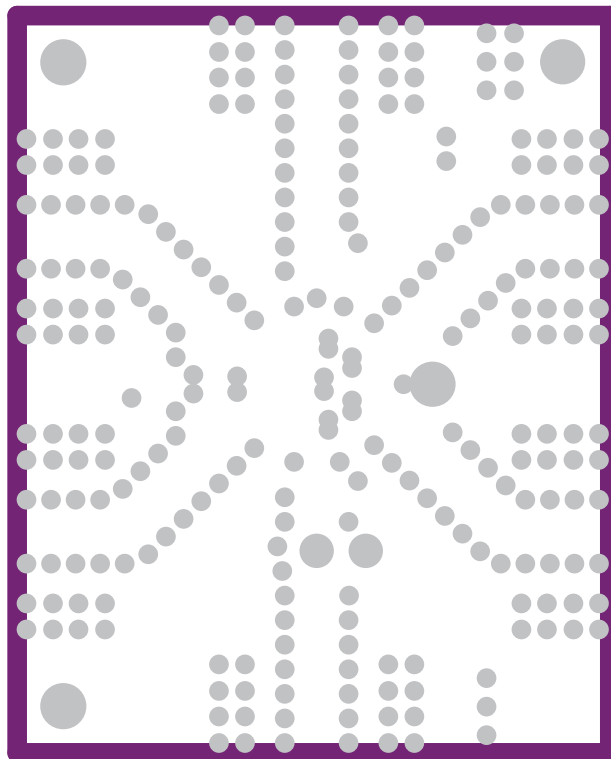

Figure 6. Layer 4

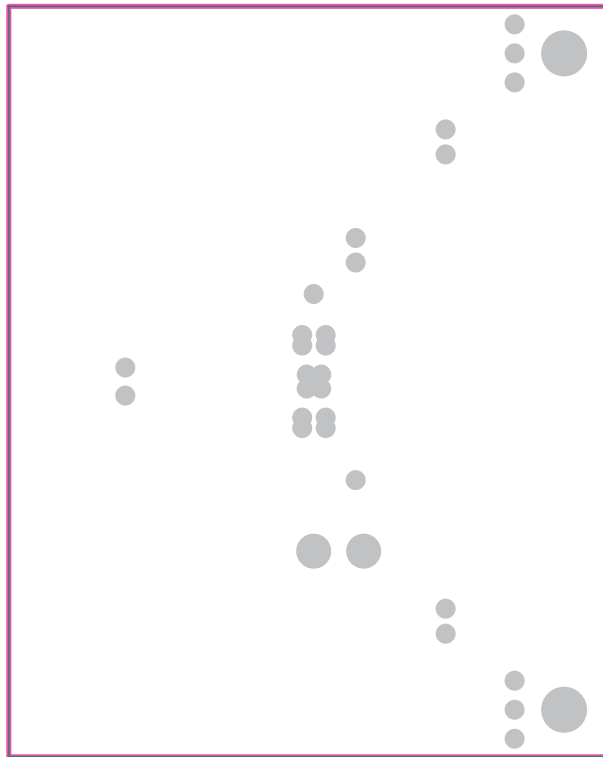

Figure 7. Layer 5

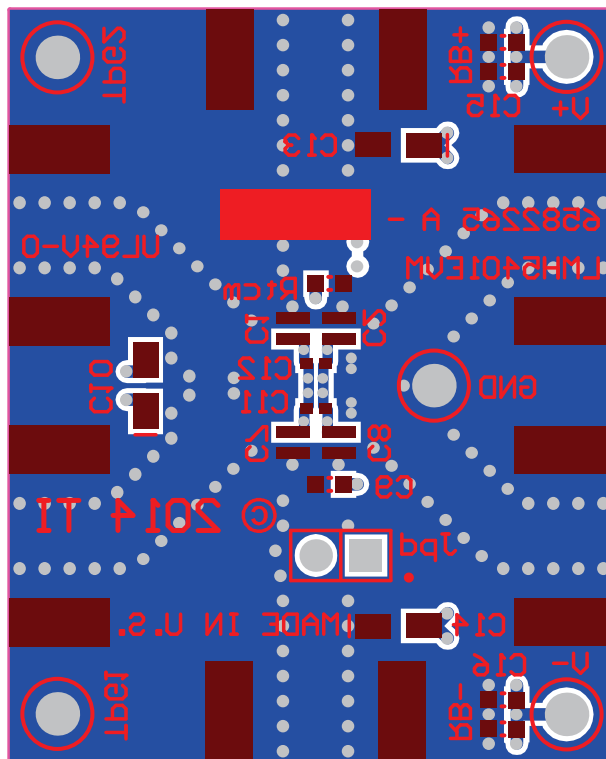

Figure 8. Bottom Layer

5.3 Bill of Materials

Table 1 lists the EVM BOM.

Table 1. LMH5401EVM Bill of Materials

Item	Designator	Value	Description	Package Reference	Manufacturer	Part Number	Quantity
1	!PCB		Printed Circuit Board		Any	6582265	1
2	C1, C2, C7, C8	0.01uF	CAP, CERM, 0.01uF, 25V, +/-20%, X7R, 0306	0306	MuRata	LLL185R71E103MA01L	4
3	C3, C4, C5, C6	2200pF	CAP, CERM, 2200pF, 50V, +/-20%, X7R, 0306	0306	MuRata	LLL185R71H222MA01L	4
4	C9	0.01uF	CAP, CERM, 0.01uF, 16V, +/-10%, X7R, 0603	0603	MuRata	GRM188R71C103KA01D	1
5	C10, C13, C14	10uF	CAP, TA, 10uF, 10V, +/-10%, 0.9 ohm, SMD	3216-18	AVX	TPSA106K010R0900	3
6	C11	0.1uF	CAP, CERM, 0.1uF, 10V, +/-10%, X5R, 0402	0402	TDK	C1005X5R1A104K	1
7	C12, C17	0.01uF	CAP, CERM, 0.01uF, 25V, +/-10%, X7R, 0402	0402	TDK	C1005X7R1E103K	2
8	GND, TPG1, TPG2	Black	Test Point, TH, Multipurpose, Black		Keystone Electronics	5011	3
9	IN+, IN-, OUT+, OUT-, PD, Vcm		Connector, SMT, End launch SMA 50 ohm	SMA End Launch	Emerson Network Power	142-0701-851	6
10	Jpd		Header, TH, 100mil, 2x1, Gold plated, 230 mil above insulator	TSW-102-07-G-S	Samtec, Inc.	TSW-102-07-G-S	1
11	R1, Ri+	365	RES, 365, 1%, 0.063 W, 0402	0402	Vishay-Dale	CRCW0402365RFKED	2
12	R2, Ri-	22.6	RES, 22.6, 1%, 0.063 W, 0402	0402	Vishay-Dale	CRCW040222R6FKED	2
13	Rcm+, Rcm-	1.00k	RES, 1.00k ohm, 1%, 0.1W, 0603	0603	Vishay-Dale	CRCW06031K00FKEA	2
14	Rf+, Rf-	127	RES, 127, 1%, 0.063 W, 0402	0402	Vishay-Dale	CRCW0402127RFKED	2
15	Ro+, Ro-	40.2	RES, 40.2 ohm, 1%, 0.063W, 0402	0402	Vishay-Dale	CRCW040240R2FKED	2
16	Rsd	49.9	RES, 49.9 ohm, 1%, 0.1W, 0603	0603	Vishay-Dale	CRCW060349R9FKEA	1
17	SH-Jpd_1-OPEN	1x2	Shunt, 100mil, Gold plated, Black		AMP	382811-6	1
18	U1		8GHz Ultra Wideband Fully Differential Amplifier, RMS0014A	RMS0014A	Texas Instruments	LMH5401RMS	1
19	V+	Red	Test Point, TH, Multipurpose, Red		Keystone Electronics	5010	1
20	V-	Yellow	Test Point, Multipurpose, Yellow, TH	Yellow Multipurpose Testpoint	Keystone	5014	1
21	C15, C16		CAP, CERM, xxxF, xxV, [TempCo], xx%, [PackageReference]	0603	Used in BOM report	Used in BOM report	0
22	RB+, RB-, Rtcn		RES, xxx ohm, x%, xW, [PackageReference]	0603	Used in BOM report	Used in BOM report	0

Revision History

Changes from Original (October 2014) to A Revision	Page
• Corrected <i>Value</i> column in Table 1 : moved all entries down by one row	9

NOTE: Page numbers for previous revisions may differ from page numbers in the current version.

STANDARD TERMS AND CONDITIONS FOR EVALUATION MODULES

1. *Delivery:* TI delivers TI evaluation boards, kits, or modules, including any accompanying demonstration software, components, or documentation (collectively, an "EVM" or "EVMs") to the User ("User") in accordance with the terms and conditions set forth herein. Acceptance of the EVM is expressly subject to the following terms and conditions.
 - 1.1 EVMs are intended solely for product or software developers for use in a research and development setting to facilitate feasibility evaluation, experimentation, or scientific analysis of TI semiconductors products. EVMs have no direct function and are not finished products. EVMs shall not be directly or indirectly assembled as a part or subassembly in any finished product. For clarification, any software or software tools provided with the EVM ("Software") shall not be subject to the terms and conditions set forth herein but rather shall be subject to the applicable terms and conditions that accompany such Software
 - 1.2 EVMs are not intended for consumer or household use. EVMs may not be sold, sublicensed, leased, rented, loaned, assigned, or otherwise distributed for commercial purposes by Users, in whole or in part, or used in any finished product or production system.
2. *Limited Warranty and Related Remedies/Disclaimers:*
 - 2.1 These terms and conditions do not apply to Software. The warranty, if any, for Software is covered in the applicable Software License Agreement.
 - 2.2 TI warrants that the TI EVM will conform to TI's published specifications for ninety (90) days after the date TI delivers such EVM to User. Notwithstanding the foregoing, TI shall not be liable for any defects that are caused by neglect, misuse or mistreatment by an entity other than TI, including improper installation or testing, or for any EVMs that have been altered or modified in any way by an entity other than TI. Moreover, TI shall not be liable for any defects that result from User's design, specifications or instructions for such EVMs. Testing and other quality control techniques are used to the extent TI deems necessary or as mandated by government requirements. TI does not test all parameters of each EVM.
 - 2.3 If any EVM fails to conform to the warranty set forth above, TI's sole liability shall be at its option to repair or replace such EVM, or credit User's account for such EVM. TI's liability under this warranty shall be limited to EVMs that are returned during the warranty period to the address designated by TI and that are determined by TI not to conform to such warranty. If TI elects to repair or replace such EVM, TI shall have a reasonable time to repair such EVM or provide replacements. Repaired EVMs shall be warranted for the remainder of the original warranty period. Replaced EVMs shall be warranted for a new full ninety (90) day warranty period.
3. *Regulatory Notices:*
 - 3.1 *United States*
 - 3.1.1 *Notice applicable to EVMs not FCC-Approved:*

This kit is designed to allow product developers to evaluate electronic components, circuitry, or software associated with the kit to determine whether to incorporate such items in a finished product and software developers to write software applications for use with the end product. This kit is not a finished product and when assembled may not be resold or otherwise marketed unless all required FCC equipment authorizations are first obtained. Operation is subject to the condition that this product not cause harmful interference to licensed radio stations and that this product accept harmful interference. Unless the assembled kit is designed to operate under part 15, part 18 or part 95 of this chapter, the operator of the kit must operate under the authority of an FCC license holder or must secure an experimental authorization under part 5 of this chapter.
 - 3.1.2 *For EVMs annotated as FCC – FEDERAL COMMUNICATIONS COMMISSION Part 15 Compliant:*

CAUTION

This device complies with part 15 of the FCC Rules. Operation is subject to the following two conditions: (1) This device may not cause harmful interference, and (2) this device must accept any interference received, including interference that may cause undesired operation.

Changes or modifications not expressly approved by the party responsible for compliance could void the user's authority to operate the equipment.

FCC Interference Statement for Class A EVM devices

NOTE: This equipment has been tested and found to comply with the limits for a Class A digital device, pursuant to part 15 of the FCC Rules. These limits are designed to provide reasonable protection against harmful interference when the equipment is operated in a commercial environment. This equipment generates, uses, and can radiate radio frequency energy and, if not installed and used in accordance with the instruction manual, may cause harmful interference to radio communications. Operation of this equipment in a residential area is likely to cause harmful interference in which case the user will be required to correct the interference at his own expense.

FCC Interference Statement for Class B EVM devices

NOTE: This equipment has been tested and found to comply with the limits for a Class B digital device, pursuant to part 15 of the FCC Rules. These limits are designed to provide reasonable protection against harmful interference in a residential installation. This equipment generates, uses and can radiate radio frequency energy and, if not installed and used in accordance with the instructions, may cause harmful interference to radio communications. However, there is no guarantee that interference will not occur in a particular installation. If this equipment does cause harmful interference to radio or television reception, which can be determined by turning the equipment off and on, the user is encouraged to try to correct the interference by one or more of the following measures:

- Reorient or relocate the receiving antenna.
- Increase the separation between the equipment and receiver.
- Connect the equipment into an outlet on a circuit different from that to which the receiver is connected.
- Consult the dealer or an experienced radio/TV technician for help.

3.2 Canada

3.2.1 For EVMs issued with an Industry Canada Certificate of Conformance to RSS-210

Concerning EVMs Including Radio Transmitters:

This device complies with Industry Canada license-exempt RSS standard(s). Operation is subject to the following two conditions: (1) this device may not cause interference, and (2) this device must accept any interference, including interference that may cause undesired operation of the device.

Concernant les EVMs avec appareils radio:

Le présent appareil est conforme aux CNR d'Industrie Canada applicables aux appareils radio exempts de licence. L'exploitation est autorisée aux deux conditions suivantes: (1) l'appareil ne doit pas produire de brouillage, et (2) l'utilisateur de l'appareil doit accepter tout brouillage radioélectrique subi, même si le brouillage est susceptible d'en compromettre le fonctionnement.

Concerning EVMs Including Detachable Antennas:

Under Industry Canada regulations, this radio transmitter may only operate using an antenna of a type and maximum (or lesser) gain approved for the transmitter by Industry Canada. To reduce potential radio interference to other users, the antenna type and its gain should be so chosen that the equivalent isotropically radiated power (e.i.r.p.) is not more than that necessary for successful communication. This radio transmitter has been approved by Industry Canada to operate with the antenna types listed in the user guide with the maximum permissible gain and required antenna impedance for each antenna type indicated. Antenna types not included in this list, having a gain greater than the maximum gain indicated for that type, are strictly prohibited for use with this device.

Concernant les EVMs avec antennes détachables

Conformément à la réglementation d'Industrie Canada, le présent émetteur radio peut fonctionner avec une antenne d'un type et d'un gain maximal (ou inférieur) approuvé pour l'émetteur par Industrie Canada. Dans le but de réduire les risques de brouillage radioélectrique à l'intention des autres utilisateurs, il faut choisir le type d'antenne et son gain de sorte que la puissance isotrope rayonnée équivalente (p.i.r.e.) ne dépasse pas l'intensité nécessaire à l'établissement d'une communication satisfaisante. Le présent émetteur radio a été approuvé par Industrie Canada pour fonctionner avec les types d'antenne énumérés dans le manuel d'usage et ayant un gain admissible maximal et l'impédance requise pour chaque type d'antenne. Les types d'antenne non inclus dans cette liste, ou dont le gain est supérieur au gain maximal indiqué, sont strictement interdits pour l'exploitation de l'émetteur.

3.3 Japan

3.3.1 *Notice for EVMs delivered in Japan:* Please see http://www.tij.co.jp/lstds/ti_ja/general/eStore/notice_01.page 日本国内に輸入される評価用キット、ボードについては、次のところをご覧ください。
http://www.tij.co.jp/lstds/ti_ja/general/eStore/notice_01.page

3.3.2 *Notice for Users of EVMs Considered "Radio Frequency Products" in Japan:* EVMs entering Japan may not be certified by TI as conforming to Technical Regulations of Radio Law of Japan.

If User uses EVMs in Japan, not certified to Technical Regulations of Radio Law of Japan, User is required by Radio Law of Japan to follow the instructions below with respect to EVMs:

1. Use EVMs in a shielded room or any other test facility as defined in the notification #173 issued by Ministry of Internal Affairs and Communications on March 28, 2006, based on Sub-section 1.1 of Article 6 of the Ministry's Rule for Enforcement of Radio Law of Japan,
2. Use EVMs only after User obtains the license of Test Radio Station as provided in Radio Law of Japan with respect to EVMs, or
3. Use of EVMs only after User obtains the Technical Regulations Conformity Certification as provided in Radio Law of Japan with respect to EVMs. Also, do not transfer EVMs, unless User gives the same notice above to the transferee. Please note that if User does not follow the instructions above, User will be subject to penalties of Radio Law of Japan.

【無線電波を送信する製品の開発キットをお使いになる際の注意事項】 開発キットの中には技術基準適合証明を受けていないものがあります。技術適合証明を受けていないものご使用に際しては、電波法遵守のため、以下のいずれかの措置を取っていただく必要がありますのでご注意ください。

1. 電波法施行規則第6条第1項第1号に基づく平成18年3月28日総務省告示第173号で定められた電波暗室等の試験設備でご使用いただく。
2. 実験局の免許を取得後ご使用いただく。
3. 技術基準適合証明を取得後ご使用いただく。

なお、本製品は、上記の「ご使用にあたっての注意」を譲渡先、移転先に通知しない限り、譲渡、移転できないものとします。

上記を遵守頂けない場合は、電波法の罰則が適用される可能性があることをご留意ください。日本テキサス・インスツルメンツ株式会社

東京都新宿区西新宿 6 丁目 2 4 番 1 号

西新宿三井ビル

3.3.3 *Notice for EVMs for Power Line Communication:* Please see http://www.tij.co.jp/llds/ti_ja/general/eStore/notice_02.page

電力線搬送波通信についての開発キットをお使いになる際の注意事項については、次のところをご覧ください。http://www.tij.co.jp/llds/ti_ja/general/eStore/notice_02.page

4 *EVM Use Restrictions and Warnings:*

4.1 EVMS ARE NOT FOR USE IN FUNCTIONAL SAFETY AND/OR SAFETY CRITICAL EVALUATIONS, INCLUDING BUT NOT LIMITED TO EVALUATIONS OF LIFE SUPPORT APPLICATIONS.

4.2 User must read and apply the user guide and other available documentation provided by TI regarding the EVM prior to handling or using the EVM, including without limitation any warning or restriction notices. The notices contain important safety information related to, for example, temperatures and voltages.

4.3 *Safety-Related Warnings and Restrictions:*

4.3.1 User shall operate the EVM within TI's recommended specifications and environmental considerations stated in the user guide, other available documentation provided by TI, and any other applicable requirements and employ reasonable and customary safeguards. Exceeding the specified performance ratings and specifications (including but not limited to input and output voltage, current, power, and environmental ranges) for the EVM may cause personal injury or death, or property damage. If there are questions concerning performance ratings and specifications, User should contact a TI field representative prior to connecting interface electronics including input power and intended loads. Any loads applied outside of the specified output range may also result in unintended and/or inaccurate operation and/or possible permanent damage to the EVM and/or interface electronics. Please consult the EVM user guide prior to connecting any load to the EVM output. If there is uncertainty as to the load specification, please contact a TI field representative. During normal operation, even with the inputs and outputs kept within the specified allowable ranges, some circuit components may have elevated case temperatures. These components include but are not limited to linear regulators, switching transistors, pass transistors, current sense resistors, and heat sinks, which can be identified using the information in the associated documentation. When working with the EVM, please be aware that the EVM may become very warm.

4.3.2 EVMs are intended solely for use by technically qualified, professional electronics experts who are familiar with the dangers and application risks associated with handling electrical mechanical components, systems, and subsystems. User assumes all responsibility and liability for proper and safe handling and use of the EVM by User or its employees, affiliates, contractors or designees. User assumes all responsibility and liability to ensure that any interfaces (electronic and/or mechanical) between the EVM and any human body are designed with suitable isolation and means to safely limit accessible leakage currents to minimize the risk of electrical shock hazard. User assumes all responsibility and liability for any improper or unsafe handling or use of the EVM by User or its employees, affiliates, contractors or designees.

4.4 User assumes all responsibility and liability to determine whether the EVM is subject to any applicable international, federal, state, or local laws and regulations related to User's handling and use of the EVM and, if applicable, User assumes all responsibility and liability for compliance in all respects with such laws and regulations. User assumes all responsibility and liability for proper disposal and recycling of the EVM consistent with all applicable international, federal, state, and local requirements.

5. *Accuracy of Information:* To the extent TI provides information on the availability and function of EVMs, TI attempts to be as accurate as possible. However, TI does not warrant the accuracy of EVM descriptions, EVM availability or other information on its websites as accurate, complete, reliable, current, or error-free.

6. *Disclaimers:*
- 6.1 EXCEPT AS SET FORTH ABOVE, EVMS AND ANY WRITTEN DESIGN MATERIALS PROVIDED WITH THE EVM (AND THE DESIGN OF THE EVM ITSELF) ARE PROVIDED "AS IS" AND "WITH ALL FAULTS." TI DISCLAIMS ALL OTHER WARRANTIES, EXPRESS OR IMPLIED, REGARDING SUCH ITEMS, INCLUDING BUT NOT LIMITED TO ANY IMPLIED WARRANTIES OF MERCHANTABILITY OR FITNESS FOR A PARTICULAR PURPOSE OR NON-INFRINGEMENT OF ANY THIRD PARTY PATENTS, COPYRIGHTS, TRADE SECRETS OR OTHER INTELLECTUAL PROPERTY RIGHTS.
- 6.2 EXCEPT FOR THE LIMITED RIGHT TO USE THE EVM SET FORTH HEREIN, NOTHING IN THESE TERMS AND CONDITIONS SHALL BE CONSTRUED AS GRANTING OR CONFERRING ANY RIGHTS BY LICENSE, PATENT, OR ANY OTHER INDUSTRIAL OR INTELLECTUAL PROPERTY RIGHT OF TI, ITS SUPPLIERS/LICENSORS OR ANY OTHER THIRD PARTY, TO USE THE EVM IN ANY FINISHED END-USER OR READY-TO-USE FINAL PRODUCT, OR FOR ANY INVENTION, DISCOVERY OR IMPROVEMENT MADE, CONCEIVED OR ACQUIRED PRIOR TO OR AFTER DELIVERY OF THE EVM.
7. *USER'S INDEMNITY OBLIGATIONS AND REPRESENTATIONS.* USER WILL DEFEND, INDEMNIFY AND HOLD TI, ITS LICENSORS AND THEIR REPRESENTATIVES HARMLESS FROM AND AGAINST ANY AND ALL CLAIMS, DAMAGES, LOSSES, EXPENSES, COSTS AND LIABILITIES (COLLECTIVELY, "CLAIMS") ARISING OUT OF OR IN CONNECTION WITH ANY HANDLING OR USE OF THE EVM THAT IS NOT IN ACCORDANCE WITH THESE TERMS AND CONDITIONS. THIS OBLIGATION SHALL APPLY WHETHER CLAIMS ARISE UNDER STATUTE, REGULATION, OR THE LAW OF TORT, CONTRACT OR ANY OTHER LEGAL THEORY, AND EVEN IF THE EVM FAILS TO PERFORM AS DESCRIBED OR EXPECTED.
8. *Limitations on Damages and Liability:*
- 8.1 *General Limitations.* IN NO EVENT SHALL TI BE LIABLE FOR ANY SPECIAL, COLLATERAL, INDIRECT, PUNITIVE, INCIDENTAL, CONSEQUENTIAL, OR EXEMPLARY DAMAGES IN CONNECTION WITH OR ARISING OUT OF THESE TERMS AND CONDITIONS OR THE USE OF THE EVMS PROVIDED HEREUNDER, REGARDLESS OF WHETHER TI HAS BEEN ADVISED OF THE POSSIBILITY OF SUCH DAMAGES. EXCLUDED DAMAGES INCLUDE, BUT ARE NOT LIMITED TO, COST OF REMOVAL OR REINSTALLATION, ANCILLARY COSTS TO THE PROCUREMENT OF SUBSTITUTE GOODS OR SERVICES, RETESTING, OUTSIDE COMPUTER TIME, LABOR COSTS, LOSS OF GOODWILL, LOSS OF PROFITS, LOSS OF SAVINGS, LOSS OF USE, LOSS OF DATA, OR BUSINESS INTERRUPTION. NO CLAIM, SUIT OR ACTION SHALL BE BROUGHT AGAINST TI MORE THAN ONE YEAR AFTER THE RELATED CAUSE OF ACTION HAS OCCURRED.
- 8.2 *Specific Limitations.* IN NO EVENT SHALL TI'S AGGREGATE LIABILITY FROM ANY WARRANTY OR OTHER OBLIGATION ARISING OUT OF OR IN CONNECTION WITH THESE TERMS AND CONDITIONS, OR ANY USE OF ANY TI EVM PROVIDED HEREUNDER, EXCEED THE TOTAL AMOUNT PAID TO TI FOR THE PARTICULAR UNITS SOLD UNDER THESE TERMS AND CONDITIONS WITH RESPECT TO WHICH LOSSES OR DAMAGES ARE CLAIMED. THE EXISTENCE OF MORE THAN ONE CLAIM AGAINST THE PARTICULAR UNITS SOLD TO USER UNDER THESE TERMS AND CONDITIONS SHALL NOT ENLARGE OR EXTEND THIS LIMIT.
9. *Return Policy.* Except as otherwise provided, TI does not offer any refunds, returns, or exchanges. Furthermore, no return of EVM(s) will be accepted if the package has been opened and no return of the EVM(s) will be accepted if they are damaged or otherwise not in a resalable condition. If User feels it has been incorrectly charged for the EVM(s) it ordered or that delivery violates the applicable order, User should contact TI. All refunds will be made in full within thirty (30) working days from the return of the components(s), excluding any postage or packaging costs.
10. *Governing Law:* These terms and conditions shall be governed by and interpreted in accordance with the laws of the State of Texas, without reference to conflict-of-laws principles. User agrees that non-exclusive jurisdiction for any dispute arising out of or relating to these terms and conditions lies within courts located in the State of Texas and consents to venue in Dallas County, Texas. Notwithstanding the foregoing, any judgment may be enforced in any United States or foreign court, and TI may seek injunctive relief in any United States or foreign court.

Mailing Address: Texas Instruments, Post Office Box 655303, Dallas, Texas 75265
Copyright © 2015, Texas Instruments Incorporated

IMPORTANT NOTICE

Texas Instruments Incorporated and its subsidiaries (TI) reserve the right to make corrections, enhancements, improvements and other changes to its semiconductor products and services per JESD46, latest issue, and to discontinue any product or service per JESD48, latest issue. Buyers should obtain the latest relevant information before placing orders and should verify that such information is current and complete. All semiconductor products (also referred to herein as "components") are sold subject to TI's terms and conditions of sale supplied at the time of order acknowledgment.

TI warrants performance of its components to the specifications applicable at the time of sale, in accordance with the warranty in TI's terms and conditions of sale of semiconductor products. Testing and other quality control techniques are used to the extent TI deems necessary to support this warranty. Except where mandated by applicable law, testing of all parameters of each component is not necessarily performed.

TI assumes no liability for applications assistance or the design of Buyers' products. Buyers are responsible for their products and applications using TI components. To minimize the risks associated with Buyers' products and applications, Buyers should provide adequate design and operating safeguards.

TI does not warrant or represent that any license, either express or implied, is granted under any patent right, copyright, mask work right, or other intellectual property right relating to any combination, machine, or process in which TI components or services are used. Information published by TI regarding third-party products or services does not constitute a license to use such products or services or a warranty or endorsement thereof. Use of such information may require a license from a third party under the patents or other intellectual property of the third party, or a license from TI under the patents or other intellectual property of TI.

Reproduction of significant portions of TI information in TI data books or data sheets is permissible only if reproduction is without alteration and is accompanied by all associated warranties, conditions, limitations, and notices. TI is not responsible or liable for such altered documentation. Information of third parties may be subject to additional restrictions.

Resale of TI components or services with statements different from or beyond the parameters stated by TI for that component or service voids all express and any implied warranties for the associated TI component or service and is an unfair and deceptive business practice. TI is not responsible or liable for any such statements.

Buyer acknowledges and agrees that it is solely responsible for compliance with all legal, regulatory and safety-related requirements concerning its products, and any use of TI components in its applications, notwithstanding any applications-related information or support that may be provided by TI. Buyer represents and agrees that it has all the necessary expertise to create and implement safeguards which anticipate dangerous consequences of failures, monitor failures and their consequences, lessen the likelihood of failures that might cause harm and take appropriate remedial actions. Buyer will fully indemnify TI and its representatives against any damages arising out of the use of any TI components in safety-critical applications.

In some cases, TI components may be promoted specifically to facilitate safety-related applications. With such components, TI's goal is to help enable customers to design and create their own end-product solutions that meet applicable functional safety standards and requirements. Nonetheless, such components are subject to these terms.

No TI components are authorized for use in FDA Class III (or similar life-critical medical equipment) unless authorized officers of the parties have executed a special agreement specifically governing such use.

Only those TI components which TI has specifically designated as military grade or "enhanced plastic" are designed and intended for use in military/aerospace applications or environments. Buyer acknowledges and agrees that any military or aerospace use of TI components which have **not** been so designated is solely at the Buyer's risk, and that Buyer is solely responsible for compliance with all legal and regulatory requirements in connection with such use.

TI has specifically designated certain components as meeting ISO/TS16949 requirements, mainly for automotive use. In any case of use of non-designated products, TI will not be responsible for any failure to meet ISO/TS16949.

Products

Audio	www.ti.com/audio
Amplifiers	amplifier.ti.com
Data Converters	dataconverter.ti.com
DLP® Products	www.dlp.com
DSP	dsp.ti.com
Clocks and Timers	www.ti.com/clocks
Interface	interface.ti.com
Logic	logic.ti.com
Power Mgmt	power.ti.com
Microcontrollers	microcontroller.ti.com
RFID	www.ti-rfid.com
OMAP Applications Processors	www.ti.com/omap
Wireless Connectivity	www.ti.com/wirelessconnectivity

Applications

Automotive and Transportation	www.ti.com/automotive
Communications and Telecom	www.ti.com/communications
Computers and Peripherals	www.ti.com/computers
Consumer Electronics	www.ti.com/consumer-apps
Energy and Lighting	www.ti.com/energy
Industrial	www.ti.com/industrial
Medical	www.ti.com/medical
Security	www.ti.com/security
Space, Avionics and Defense	www.ti.com/space-avionics-defense
Video and Imaging	www.ti.com/video

TI E2E Community

e2e.ti.com