

LM4923

LM4923 1.1 Watt Fully Differential Audio Power Amplifier With Shutdown

Select



Literature Number: SNAS211D

1.1 Watt Fully Differential Audio Power Amplifier With Shutdown Select

General Description

The LM4923 is a fully differential audio power amplifier primarily designed for demanding applications in mobile phones and other portable communication device applications. It is capable of delivering 1.1 watt of continuous average power to an 8Ω BTL load with less than 1% distortion (THD+N) from a 5V_{DC} power supply.

Boomer audio power amplifiers were designed specifically to provide high quality output power with a minimal amount of external components. The LM4923 does not require output coupling capacitors or bootstrap capacitors, and therefore is ideally suited for mobile phone and other low voltage applications where minimal power consumption is a primary requirement.

The LM4923 features a low-power consumption shutdown mode. To facilitate this, Shutdown may be enabled by logic low. Additionally, the LM4923 features an internal thermal shutdown protection mechanism.

The LM4923 contains advanced pop & click circuitry which eliminates noises which would otherwise occur during turn-on and turn-off transitions.

Key Specifications

■ Improved PSRR at 217Hz	85dB(typ)
■ Power Output at 5.0V @ 1% THD+N	1.1W(typ)
■ Power Output at 3.3V @ 1% THD+N	400mW(typ)
■ Shutdown Current	0.1μA(typ)

Features

- Fully differential amplification
- Available in space-saving LLP package
- Ultra low current shutdown mode
- Can drive capacitive loads up to 100pF
- Improved pop & click circuitry eliminates noises during turn-on and turn-off transitions
- 2.4 - 5.5V operation
- No output coupling capacitors, snubber networks or bootstrap capacitors required

Applications

- Mobile phones
- PDAs
- Portable electronic devices

Connection Diagrams

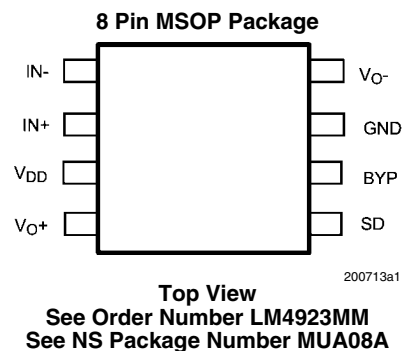
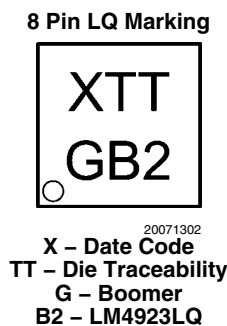
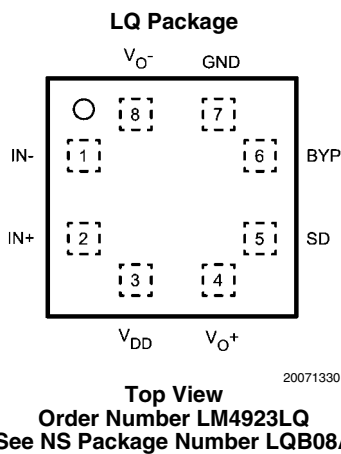

Typical Application

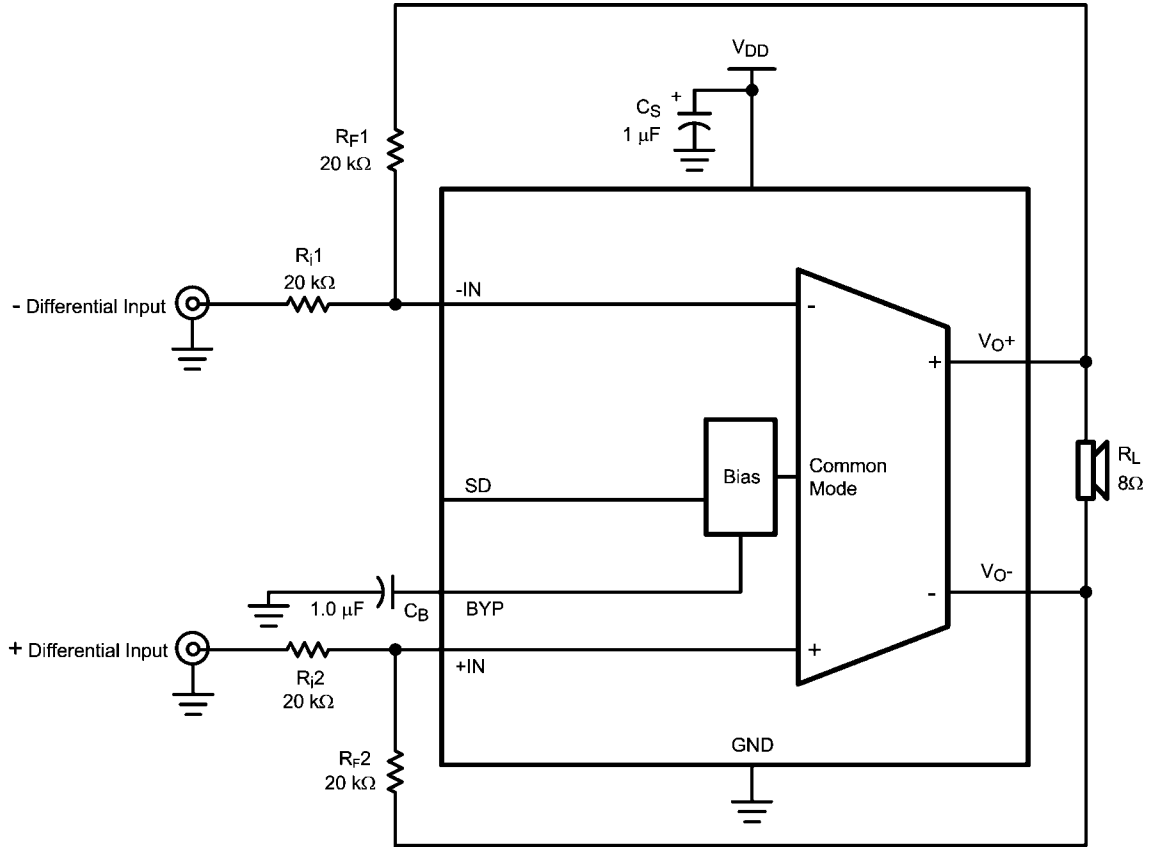

20071313

FIGURE 1. Typical Audio Amplifier Application Circuit

Absolute Maximum Ratings (Note 2)

If Military/Aerospace specified devices are required, please contact the National Semiconductor Sales Office/Distributors for availability and specifications.

Supply Voltage	6.0V
Storage Temperature	-65°C to +150°C
Input Voltage	-0.3V to $V_{DD} + 0.3V$
Power Dissipation (Note 3)	Internally Limited
ESD Susceptibility (Note 4)	2000V
ESD Susceptibility (Note 5)	200V
Junction Temperature	150°C
Thermal Resistance	

θ_{JA} (LLP)	140°C/W
θ_{JA} (MM)	210°C/W
θ_{JC} (MM)	56°C/W

Soldering Information
See AN-1187

Operating Ratings

Temperature Range	
$T_{MIN} \leq T_A \leq T_{MAX}$	-40°C \leq T_A \leq 85°C
Supply Voltage	2.4V \leq V_{DD} \leq 5.5V

Electrical Characteristics $V_{DD} = 5V$ (Notes 1, 2)

The following specifications apply for $V_{DD} = 5V$, $A_V = 1$, and 8Ω load unless otherwise specified. Limits apply for $T_A = 25^\circ\text{C}$.

Symbol	Parameter	Conditions	LM4923		Units (Limits)
			Typical	Limit	
			(Note 6)	(Note 7)	
I_{DD}	Quiescent Power Supply Current	$V_{IN} = 0V$, no load	4	9	mA (max)
		$V_{IN} = 0V$, $R_L = 8\Omega$	4	9	
I_{SD}	Shutdown Current	$V_{SHUTDOWN} = GND$	0.1	1	μA (max)
P_o	Output Power	THD = 1% (max); $f = 1\text{ kHz}$			
		LM4923, $R_L = 8\Omega$	1.1	1	
THD+N	Total Harmonic Distortion+Noise	$P_o = 0.4\text{ Wrms}$; $f = 1\text{ kHz}$	0.02		%
PSRR	Power Supply Rejection Ratio	$V_{ripple} = 200\text{mV sine p-p}$			
		$f = 217\text{Hz}$ (Note 8)	85	73	
		$f = 1\text{kHz}$ (Note 8)	85	73	
CMRR	Common_Mode Rejection Ratio	$f = 217\text{Hz}$, $V_{CM} = 200\text{mV}_{pp}$	50		dB
V_{OS}	Output Offset	$V_{IN} = 0V$	4		mV
V_{SDIH}	Shutdown Voltage Input High		0.9		V
V_{SDIL}	Shutdown Voltage Input Low		0.7		V

Electrical Characteristics $V_{DD} = 3V$ (Notes 1, 2)

The following specifications apply for $V_{DD} = 3V$, $A_V = 1$, and 8Ω load unless otherwise specified. Limits apply for $T_A = 25^\circ\text{C}$.

Symbol	Parameter	Conditions	LM4923		Units (Limits)
			Typical	Limit	
			(Note 6)	(Note 7)	
I_{DD}	Quiescent Power Supply Current	$V_{IN} = 0V$, no load	3	5.5	mA (max)
		$V_{IN} = 0V$, $R_L = 8\Omega$	3	5.5	
I_{SD}	Shutdown Current	$V_{SHUTDOWN} = GND$	0.1	1	μA (max)
P_o	Output Power	THD = 1% (max); $f = 1\text{ kHz}$			W
		LM4923, $R_L = 8\Omega$	0.375		
THD+N	Total Harmonic Distortion+Noise	$P_o = 0.25\text{ Wrms}$; $f = 1\text{ kHz}$	0.02		%
PSRR	Power Supply Rejection Ratio	$V_{ripple} = 200\text{mV sine p-p}$			
		$f = 217\text{Hz}$ (Note 8)	85		
		$f = 1\text{kHz}$ (Note 8)	85	73	
CMRR	Common-Mode Rejection Ratio	$f = 217\text{Hz}$, $V_{CM} = 200\text{mV}_{pp}$	50		dB
V_{OS}	Output Offset	$V_{IN} = 0V$	4		mV

Symbol	Parameter	Conditions	LM4923		Units (Limits)
			Typical	Limit	
			(Note 6)	(Note 7)	
V_{SDIH}	Shutdown Voltage Input High		0.8		V
V_{SDIL}	Shutdown Voltage Input Low		0.6		V

Note 1: All voltages are measured with respect to the ground pin, unless otherwise specified.

Note 2: *Absolute Maximum Ratings* indicate limits beyond which damage to the device may occur. *Operating Ratings* indicate conditions for which the device is functional, but do not guarantee specific performance limits. *Electrical Characteristics* state DC and AC electrical specifications under particular test conditions which guarantee specific performance limits. This assumes that the device is within the Operating Ratings. Specifications are not guaranteed for parameters where no limit is given, however, the typical value is a good indication of device performance.

Note 3: The maximum power dissipation must be derated at elevated temperatures and is dictated by T_{JMAX} , θ_{JA} , and the ambient temperature T_A . The maximum allowable power dissipation is $P_{DMAX} = (T_{JMAX} - T_A) / \theta_{JA}$ or the number given in Absolute Maximum Ratings, whichever is lower. For the LM4923, see power derating curve for additional information.

Note 4: Human body model, 100pF discharged through a 1.5k Ω resistor.

Note 5: Machine Model, 220pF – 240pF discharged through all pins.

Note 6: Typicals are measured at 25°C and represent the parametric norm.

Note 7: Datasheet min/max specification limits are guaranteed by design, test, or statistical analysis.

Note 8: 10 Ω terminated input.

External Components Description

(Figure 1)

Components		Functional Description
1.	R_i	Inverting input resistance which sets the closed-loop gain in conjunction with R_f .
2.	R_f	Feedback resistance which sets the closed-loop gain in conjunction with R_i .
3.	C_S	Supply bypass capacitor which provides power supply filtering. Refer to the Power Supply Bypassing section for information concerning proper placement and selection of the supply bypass capacitor.
4.	C_B	Bypass pin capacitor which provides half-supply filtering. Refer to the section, Proper Selection of External Components , for information concerning proper placement and selection of C_B .

Typical Performance Characteristics

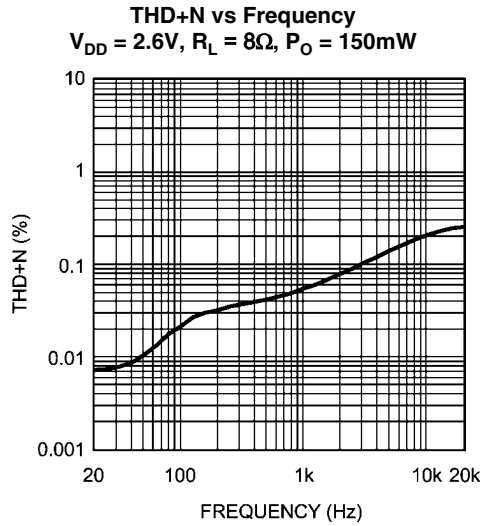

20071306

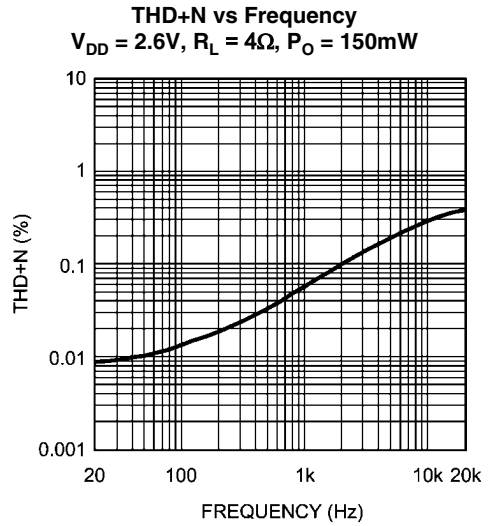

20071305

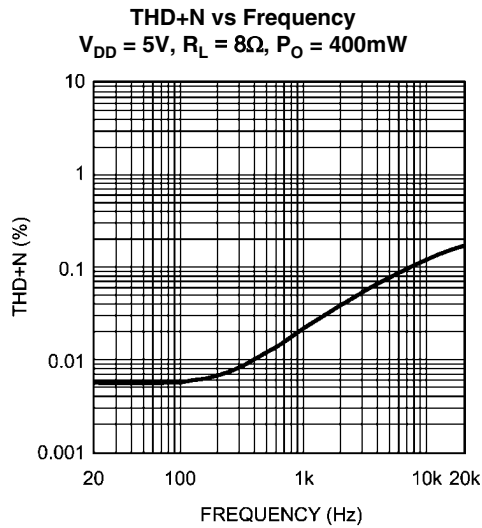

20071309

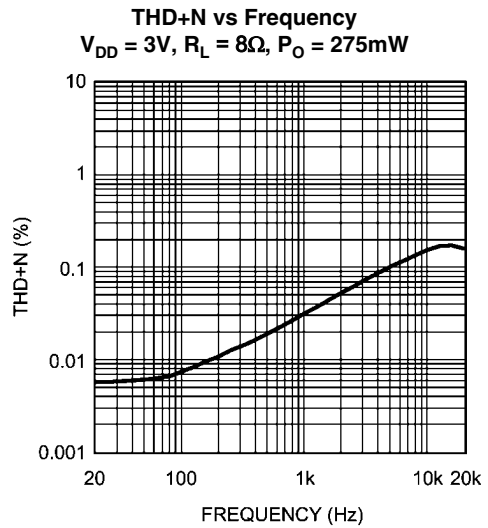

20071308

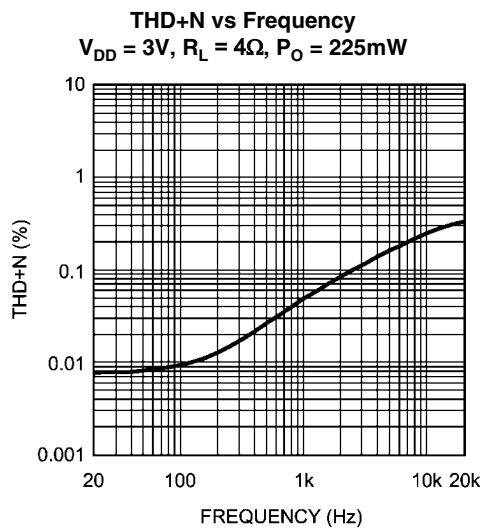

20071307

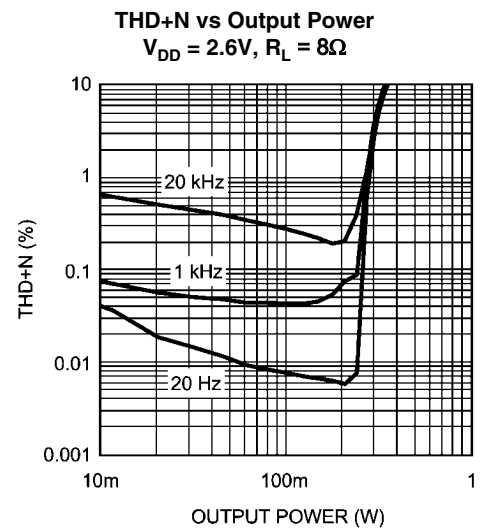

20071311

THD+N vs Output Power
 $V_{DD} = 2.6V, R_L = 4\Omega$

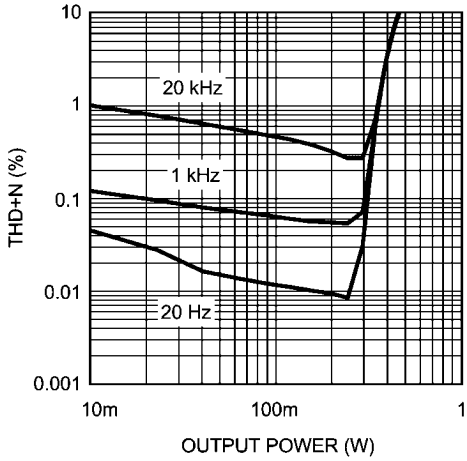

20071310

THD+N vs Output Power
 $V_{DD} = 5V, R_L = 8\Omega$

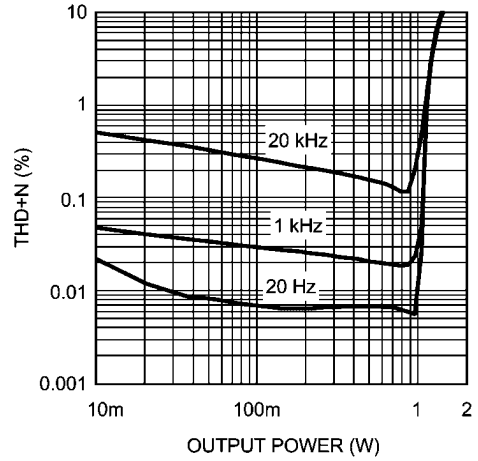

20071315

THD+N vs Output Power
 $V_{DD} = 3V, R_L = 8\Omega$

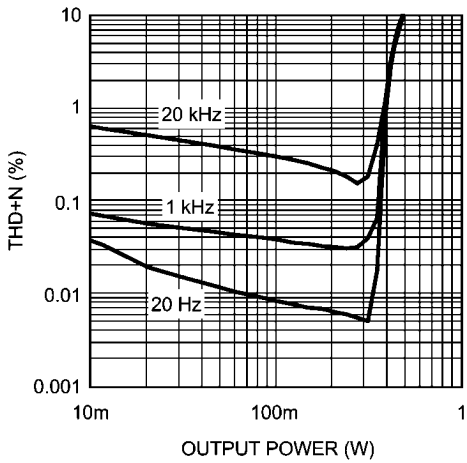

20071314

THD+N vs Output Power
 $V_{DD} = 3V, R_L = 4\Omega$

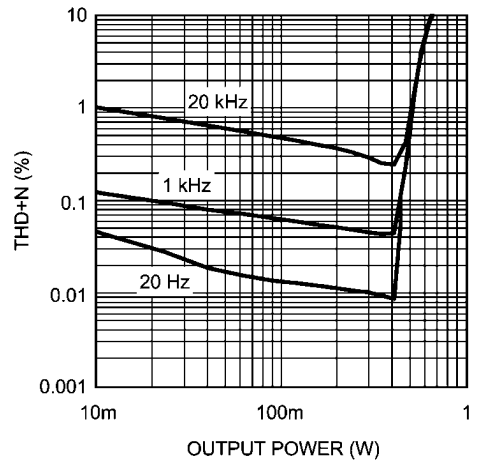

20071312

PSRR vs Frequency
 $V_{DD} = 5V, R_L = 8\Omega, \text{Input terminated}$

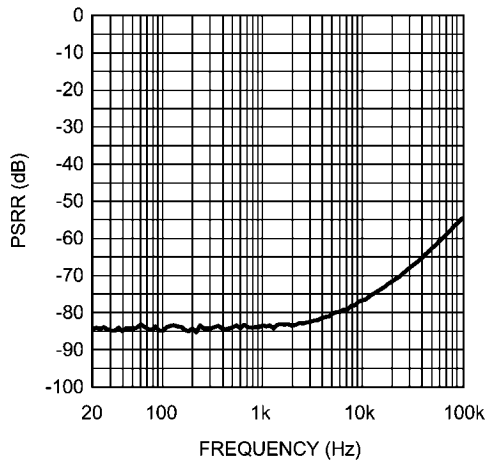

20071304

PSRR vs Frequency
 $V_{DD} = 3V, R_L = 8\Omega, \text{Input terminated}$

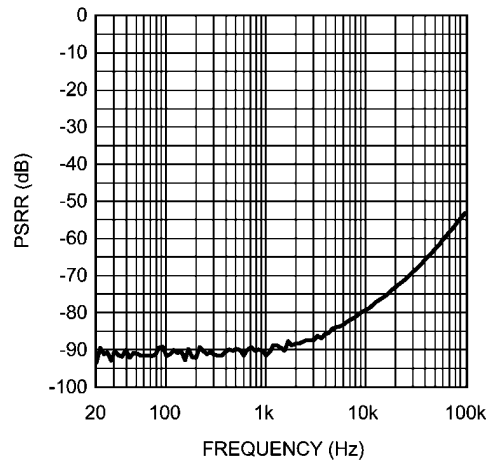

20071303

Output Power vs Supply Voltage
 $R_L = 8\Omega$

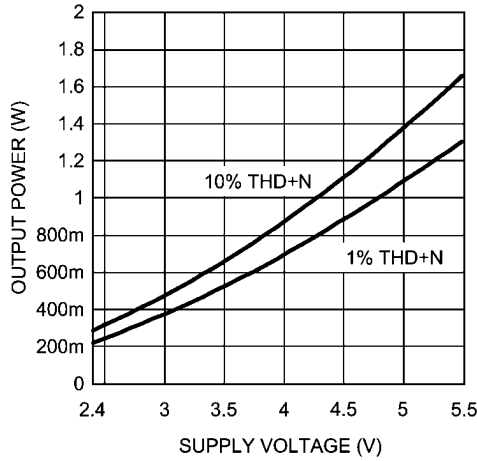

20071301

CMRR vs Frequency
 $V_{DD} = 5V, R_L = 8\Omega$

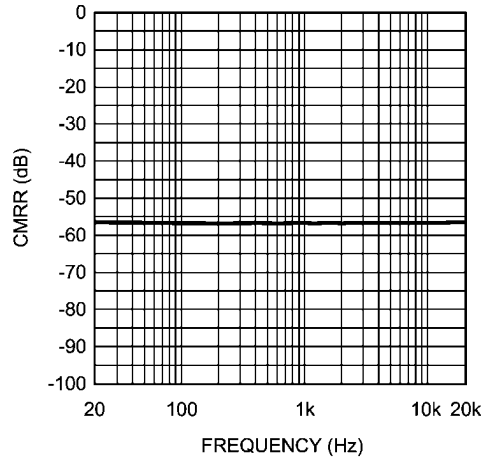

20071317

CMRR vs Frequency
 $V_{DD} = 3V, R_L = 8\Omega$

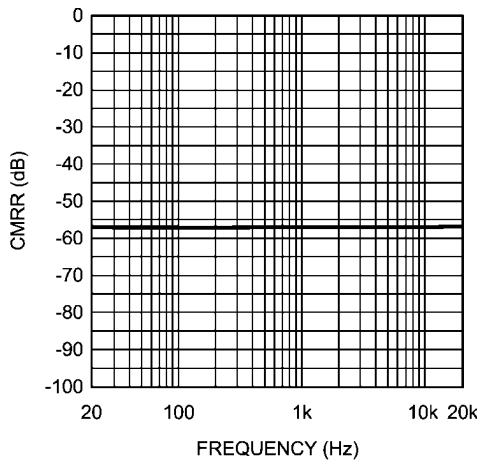

20071326

PSRR vs Common Mode Voltage
 $V_{DD} = 3V, R_L = 8\Omega, f = 217Hz$

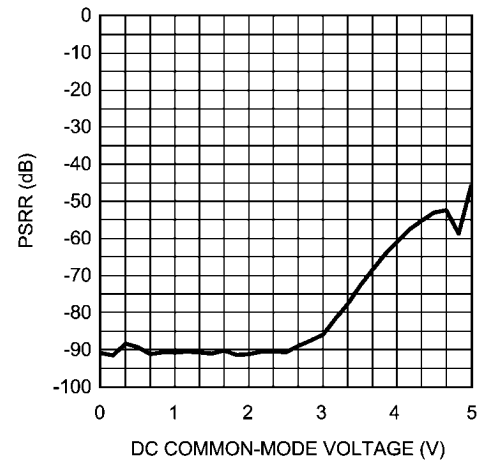

20071322

PSRR vs Common Mode Voltage
 $V_{DD} = 5V, R_L = 8\Omega, f = 217Hz$

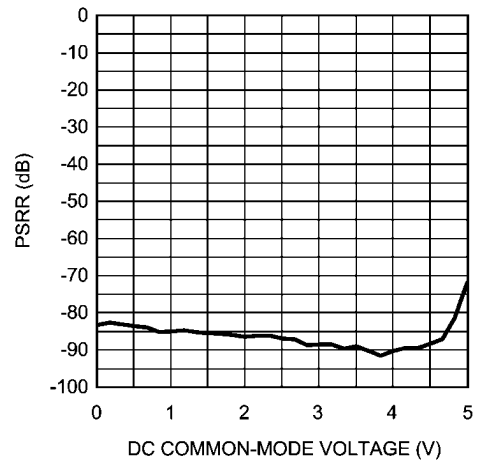

20071316

Power Dissipation vs Output Power
 $V_{DD} = 2.6V, R_L = 8\Omega \text{ and } 4\Omega$

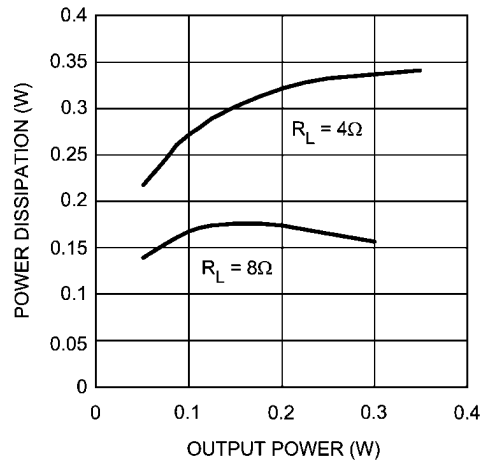

20071321

Power Dissipation vs Output Power
 $V_{DD} = 5V, R_L = 8\Omega$

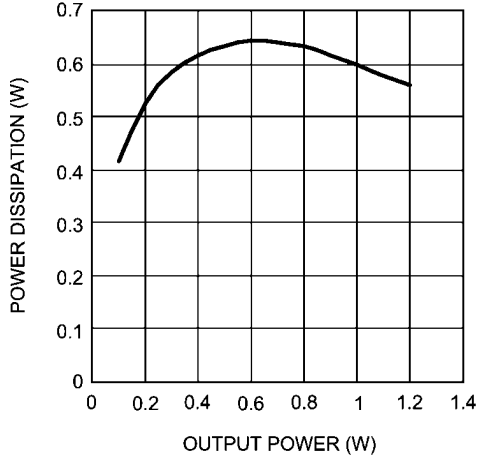

20071319

Power Dissipation vs Output Power
 $V_{DD} = 3V, R_L = 8\Omega$

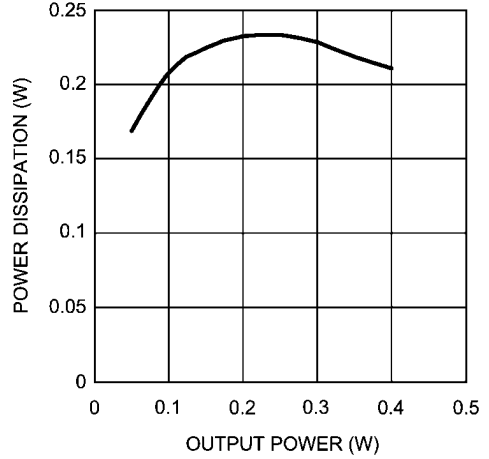

20071325

Power Derating Curve

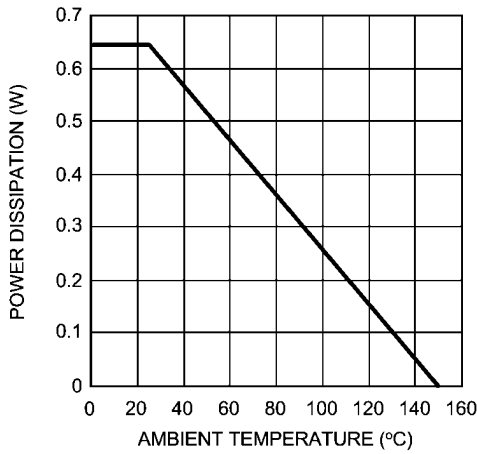

20071318

Noise Floor
 $V_{DD} = 5V$

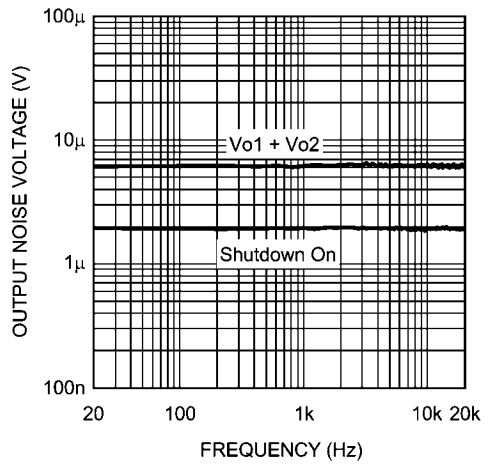

20071324

Noise Floor
 $V_{DD} = 3V$

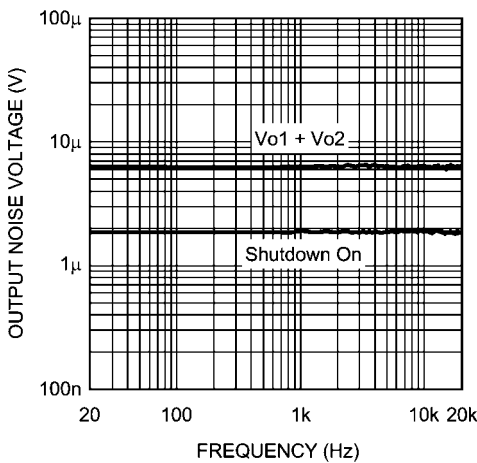

20071320

Clipping Voltage vs Supply Voltage

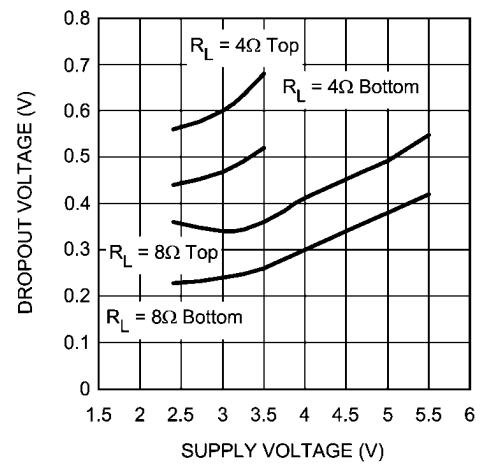

20071323

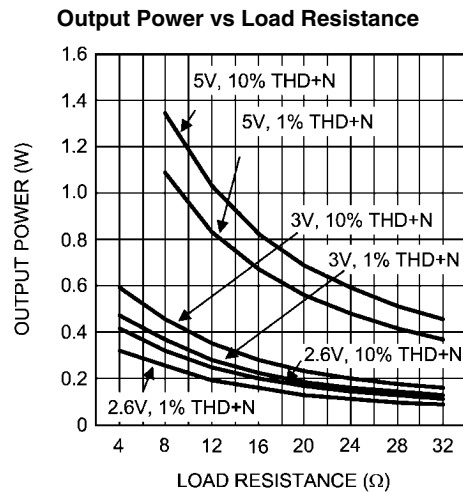

20071327

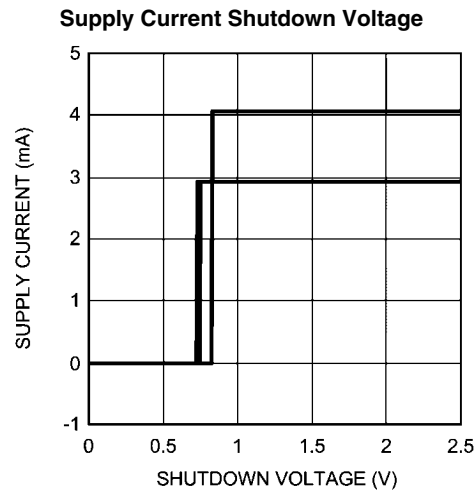

20071328

Application Information

DIFFERENTIAL AMPLIFIER EXPLANATION

The LM4923 is a fully differential audio amplifier that features differential input and output stages. Internally this is accomplished by two circuits: a differential amplifier and a common mode feedback amplifier that adjusts the output voltages so that the average value remains $V_{DD} / 2$. When setting the differential gain, the amplifier can be considered to have "halves". Each half uses an input and feedback resistor (R_{i1} and R_{F1}) to set its respective closed-loop gain (see Figure 1). With $R_{i1} = R_{i2}$ and $R_{F1} = R_{F2}$, the gain is set at $-R_F / R_i$ for each half. This results in a differential gain of

$$A_{VD} = -R_F / R_i \quad (1)$$

It is extremely important to match the input resistors to each other, as well as the feedback resistors to each other for best amplifier performance. See the **Proper Selection of External Components** section for more information. A differential amplifier works in a manner where the difference between the two input signals is amplified. In most applications, this would require input signals that are 180° out of phase with each other. The LM4923 can be used, however, as a single ended input amplifier while still retaining its fully differential benefits. In fact, completely unrelated signals may be placed on the input pins. The LM4923 simply amplifies the difference between them.

All of these applications provide what is known as a "bridged mode" output (bridge-tied-load, BTL). This results in output signals at V_{o1} and V_{o2} that are 180° out of phase with respect to each other. Bridged mode operation is different from the single-ended amplifier configuration that connects the load between the amplifier output and ground. A bridged amplifier design has distinct advantages over the single-ended configuration: it provides differential drive to the load, thus doubling maximum possible output swing for a specific supply voltage. Four times the output power is possible compared with a single-ended amplifier under the same conditions. This increase in attainable output power assumes that the amplifier is not current limited or clipped. In order to choose an amplifier's closed-loop gain without causing excess clipping, please refer to the **Audio Power Amplifier Design** section.

A bridged configuration, such as the one used in the LM4923, also creates a second advantage over single-ended ampli-

fiers. Since the differential outputs, V_{o1} and V_{o2} , are biased at half-supply, no net DC voltage exists across the load. This assumes that the input resistor pair and the feedback resistor pair are properly matched (see **Proper Selection of External Components**). BTL configuration eliminates the output coupling capacitor required in single-supply, single-ended amplifier configurations. If an output coupling capacitor is not used in a single-ended output configuration, the half-supply bias across the load would result in both increased internal IC power dissipation as well as permanent loudspeaker damage. Further advantages of bridged mode operation specific to fully differential amplifiers like the LM4923 include increased power supply rejection ratio, common-mode noise reduction, and click and pop reduction.

EXPOSED-DAP PACKAGE PCB MOUNTING CONSIDERATIONS

The LM4923's exposed-DAP (die attach paddle) package (LLP) provide a low thermal resistance between the die and the PCB to which the part is mounted and soldered. This allows rapid heat transfer from the die to the surrounding PCB copper traces, ground plane and, finally, surrounding air. Failing to optimize thermal design may compromise the LM4923's high power performance and activate unwanted, though necessary, thermal shutdown protection. The LLP package must have its DAP soldered to a copper pad on the PCB. The DAP's PCB copper pad is connected to a large plane of continuous unbroken copper. This plane forms a thermal mass and heat sink and radiation area. Place the heat sink area on either outside plane in the case of a two-sided PCB, or on an inner layer of a board with more than two layers. Connect the DAP copper pad to the inner layer or backside copper heat sink area with a thermal via. The via diameter should be 0.012in - 0.013in. Ensure efficient thermal conductivity by plating-through and solder-filling the vias.

Best thermal performance is achieved with the largest practical copper heat sink area. In all circumstances and conditions, the junction temperature must be held below 150°C to prevent activating the LM4923's thermal shutdown protection. The LM4923's power de-rating curve in the Typical Performance Characteristics shows the maximum power dissipation versus temperature. Example PCB layouts are shown in the Demonstration Board Layout section. Further detailed and specific information concerning PCB layout, fabrication, and mounting an LLP package is available from National

Semiconductor's package Engineering Group under application note AN1187.

PCB LAYOUT AND SUPPLY REGULATION CONSIDERATIONS FOR DRIVING 4Ω LOADS

Power dissipated by a load is a function of the voltage swing across the load and the load's impedance. As load impedance decreases, load dissipation becomes increasingly dependent on the interconnect (PCB trace and wire) resistance between the amplifier output pins and the load's connections. Residual trace resistance causes a voltage drop, which results in power dissipated in the trace and not in the load as desired. This problem of decreased load dissipation is exacerbated as load impedance decreases. Therefore, to maintain the highest load dissipation and widest output voltage swing, PCB traces that connect the output pins to a load must be as wide as possible.

Poor power supply regulation adversely affects maximum output power. A poorly regulated supply's output voltage decreases with increasing load current. Reduced supply voltage causes decreased headroom, output signal clipping, and reduced output power. Even with tightly regulated supplies, trace resistance creates the same effects as poor supply regulation. Therefore, making the power supply traces as wide as possible helps maintain full output voltage swing.

POWER DISSIPATION

Power dissipation is a major concern when designing a successful amplifier, whether the amplifier is bridged or single-ended. Equation 2 states the maximum power dissipation point for a single-ended amplifier operating at a given supply voltage and driving a specified output load.

$$P_{\text{DMAX}} = (V_{\text{DD}})^2 / (2\pi^2 R_L) \text{ Single-Ended} \quad (2)$$

However, a direct consequence of the increased power delivered to the load by a bridge amplifier is an increase in internal power dissipation versus a single-ended amplifier operating at the same conditions.

$$P_{\text{DMAX}} = 4 * (V_{\text{DD}})^2 / (2\pi^2 R_L) \text{ Bridge Mode} \quad (3)$$

Since the LM4923 has bridged outputs, the maximum internal power dissipation is 4 times that of a single-ended amplifier. Even with this substantial increase in power dissipation, the LM4923 does not require additional heatsinking under most operating conditions and output loading. From Equation 3, assuming a 5V power supply and an 8Ω load, the maximum power dissipation point is 625mW. The maximum power dissipation point obtained from Equation 3 must not be greater than the power dissipation results from Equation 4:

$$P_{\text{DMAX}} = (T_{\text{JMAX}} - T_{\text{A}}) / \theta_{\text{JA}} \quad (4)$$

The LM4923's θ_{JA} in an LQB08A package is 140°C/W. Depending on the ambient temperature, T_{A} , of the system surroundings, Equation 4 can be used to find the maximum internal power dissipation supported by the IC packaging. If the result of Equation 3 is greater than that of Equation 4, then either the supply voltage must be decreased, the load impedance increased, the ambient temperature reduced, or the θ_{JA} reduced with heatsinking. In many cases, larger traces near the output, V_{DD} , and GND pins can be used to lower the θ_{JA} . The larger areas of copper provide a form of heatsinking

allowing higher power dissipation. For the typical application of a 5V power supply, with an 8Ω load, the maximum ambient temperature possible without violating the maximum junction temperature is approximately 62°C provided that device operation is around the maximum power dissipation point. Recall that internal power dissipation is a function of output power. If typical operation is not around the maximum power dissipation point, the LM4923 can operate at higher ambient temperatures. Refer to the **Typical Performance Characteristics** curves for power dissipation information.

POWER SUPPLY BYPASSING

As with any power amplifier, proper supply bypassing is critical for low noise performance and high power supply rejection ratio (PSRR). The capacitor location on both the bypass and power supply pins should be as close to the device as possible. A larger half-supply bypass capacitor improves PSRR because it increases half-supply stability. Typical applications employ a 5V regulator with 10μF and 0.1μF bypass capacitors that increase supply stability. This, however, does not eliminate the need for bypassing the supply nodes of the LM4923. The LM4923 will operate without the bypass capacitor C_{B} , although the PSRR may decrease. A 1μF capacitor is recommended for C_{B} . This value maximizes PSRR performance. Lesser values may be used, but PSRR decreases at frequencies below 1kHz. The issue of C_{B} selection is thus dependant upon desired PSRR and click and pop performance as explained in the section **Proper Selection of External Components**.

SHUTDOWN FUNCTION

In order to reduce power consumption while not in use, the LM4923 contains shutdown circuitry that is used to turn off the amplifier's bias circuitry. The device may then be placed into shutdown mode by toggling the Shutdown Select pin to logic low. The trigger point for shutdown is shown as a typical value in the Supply Current vs Shutdown Voltage graphs in the **Typical Performance Characteristics** section. It is best to switch between ground and supply for maximum performance. While the device may be disabled with shutdown voltages in between ground and supply, the idle current may be greater than the typical value of 0.1μA. In either case, the shutdown pin should be tied to a definite voltage to avoid unwanted state changes.

In many applications, a microcontroller or microprocessor output is used to control the shutdown circuitry, which provides a quick, smooth transition to shutdown. Another solution is to use a single-throw switch in conjunction with an external pull-up resistor. This scheme guarantees that the shutdown pin will not float, thus preventing unwanted state changes.

PROPER SELECTION OF EXTERNAL COMPONENTS

Proper selection of external components in applications using integrated power amplifiers is critical when optimizing device and system performance. Although the LM4923 is tolerant to a variety of external component combinations, consideration of component values must be made when maximizing overall system quality.

The LM4923 is unity-gain stable, giving the designer maximum system flexibility. The LM4923 should be used in low closed-loop gain configurations to minimize THD+N values and maximize signal to noise ratio. Low gain configurations require large input signals to obtain a given output power. Input signals equal to or greater than 1V_{rms} are available from sources such as audio codecs. Please refer to the Audio Power Amplifier Design section for a more complete expla-

nation of proper gain selection. When used in its typical application as a fully differential power amplifier the LM4923 does not require input coupling capacitors for input sources with DC common-mode voltages of less than V_{DD} . Exact allowable input common-mode voltage levels are actually a function of V_{DD} , R_i , and R_f and may be determined by Equation 5:

$$V_{CMi} < (V_{DD}-1.2) * ((R_f + (R_i)/(R_i)) - V_{DD} * (R_i / 2R_f)) \quad (5)$$

$$-R_f / R_i = A_{VD} \quad (6)$$

Special care must be taken to match the values of the feedback resistors (R_{F1} and R_{F2}) to each other as well as matching the input resistors (R_{i1} and R_{i2}) to each other (see Figure 1) more in front. Because of the balanced nature of differential amplifiers, resistor matching differences can result in net DC currents across the load. This DC current can increase power consumption, internal IC power dissipation, reduce PSRR, and possibly damaging the loudspeaker. The chart below demonstrates this problem by showing the effects of differing values between the feedback resistors while assuming that the input resistors are perfectly matched. The results below apply to the application circuit shown in Figure 1, and assumes that $V_{DD} = 5V$, $R_L = 8\Omega$, and the system has DC coupled inputs tied to ground.

Tolerance	R_{F1}	R_{F2}	$V_{O2} - V_{O1}$	I_{LOAD}
20%	0.8R	1.2R	-0.500V	62.5mA
10%	0.9R	1.1R	-0.250V	31.25mA
5%	0.95R	1.05R	-0.125V	15.63mA
1%	0.99R	1.01R	-0.025V	3.125mA
0%	R	R	0	0

Similar results would occur if the input resistors were not carefully matched. Adding input coupling capacitors in between the signal source and the input resistors will eliminate this problem, however, to achieve best performance with minimum component count it is highly recommended that both the feedback and input resistors matched to 1% tolerance or better.

AUDIO POWER AMPLIFIER DESIGN

Design a 1W/8Ω Audio Amplifier

Given:

Power Output	1Wrms
Load Impedance	8Ω
Input Level	1Vrms
Input Impedance	20kΩ
Bandwidth	100Hz–20kHz ± 0.25dB

A designer must first determine the minimum supply rail to obtain the specified output power. The supply rail can easily be found by extrapolating from the Output Power vs Supply Voltage graphs in the **Typical Performance Characteristics** section. A second way to determine the minimum supply rail is to calculate the required V_{OPEAK} using Equation 7 and add the dropout voltages. Using this method, the minimum supply voltage is ($V_{Opeak} + (V_{DO TOP} + (V_{DO BOT}))$), where $V_{DO BOT}$ and $V_{DO TOP}$ are extrapolated from the Dropout Voltage vs Supply Voltage curve in the **Typical Performance Characteristics** section.

$$V_{Opeak} = \sqrt{(2R_L P_O)} \quad (7)$$

Using the Output Power vs Supply Voltage graph for an 8Ω load, the minimum supply rail just about 5V. Extra supply voltage creates headroom that allows the LM4923 to reproduce peaks in excess of 1W without producing audible distortion. At this time, the designer must make sure that the power supply choice along with the output impedance does not violate the conditions explained in the **Power Dissipation** section. Once the power dissipation equations have been addressed, the required differential gain can be determined from Equation 8.

$$A_{VD} \geq \sqrt{(P_O R_L)} / (V_{IN}) = V_{Orms} / V_{Inrms} \quad (8)$$

$$R_f / R_i = A_{VD}$$

From Equation 7, the minimum A_{VD} is 2.83. Since the desired input impedance was 20kΩ, a ratio of 2.83:1 of R_f to R_i results in an allocation of $R_i = 20k\Omega$ for both input resistors and $R_f = 60k\Omega$ for both feedback resistors. The final design step is to address the bandwidth requirement which must be stated as a single -3dB frequency point. Five times away from a -3dB point is 0.17dB down from passband response which is better than the required ±0.25dB specified.

$$f_H = 20kHz * 5 = 100kHz$$

The high frequency pole is determined by the product of the desired frequency pole, f_H , and the differential gain, A_{VD} . With a $A_{VD} = 2.83$ and $f_H = 100kHz$, the resulting GBWP = 150kHz which is much smaller than the LM4923 GBWP of 10MHz. This figure displays that if a designer has a need to design an amplifier with a higher differential gain, the LM4923 can still be used without running into bandwidth limitations.

Revision History

Rev	Date	Description
1.0	09/28/07	Added the MSOP package, then released.
1.01	12/17/07	Updated the mktg outline LQB08A into the rev B.
1.02	02/19/09	Fixed typo labels on the typical circuit diagram.

Physical Dimensions inches (millimeters) unless otherwise noted

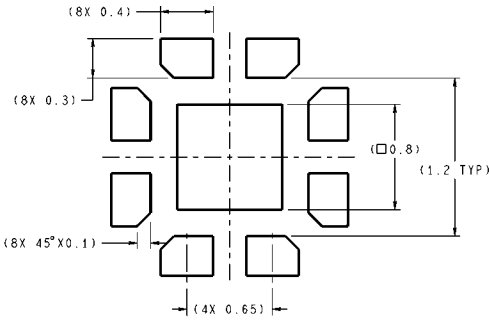

DIMENSIONS ARE IN MILLIMETERS

RECOMMENDED LAND PATTERN
1:1 RATIO WITH PKG SOLDER PADS

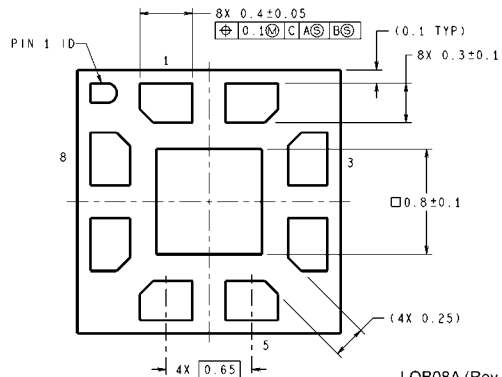
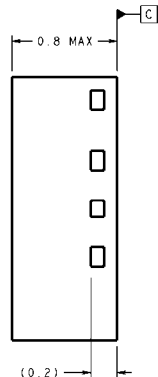
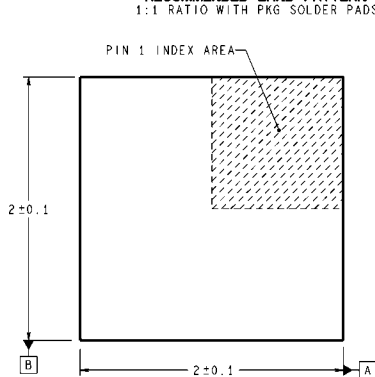

LQB08A (Rev B)

LQ Package
Order Number LM4923LQ
NS Package Number LQB08A

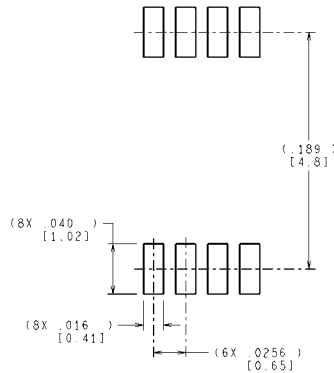
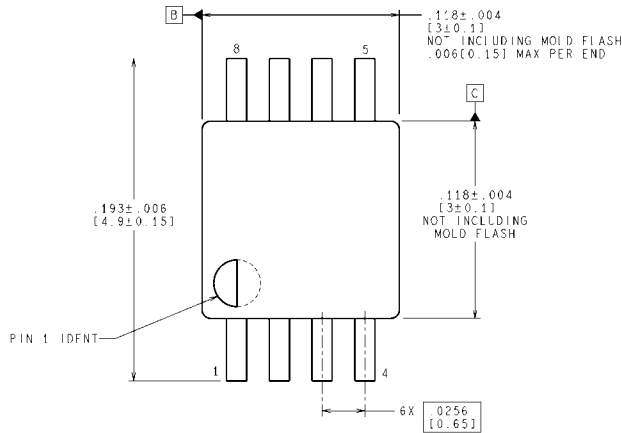

RECOMMENDED LAND PATTERN

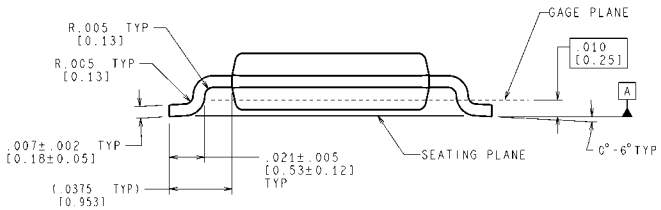
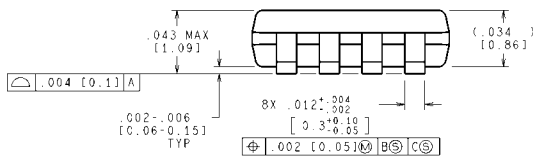

CONTROLLING DIMENSION IS INCH
VALUES IN [] ARE MILLIMETERS

MUA08A (Rev F)

MSOP Package
Order Number LM4923MM
NS Package Number MUA08A

Notes

For more National Semiconductor product information and proven design tools, visit the following Web sites at:

Products		Design Support	
Amplifiers	www.national.com/amplifiers	WEBENCH® Tools	www.national.com/webench
Audio	www.national.com/audio	App Notes	www.national.com/appnotes
Clock and Timing	www.national.com/timing	Reference Designs	www.national.com/refdesigns
Data Converters	www.national.com/adc	Samples	www.national.com/samples
Interface	www.national.com/interface	Eval Boards	www.national.com/evalboards
LVDS	www.national.com/lvds	Packaging	www.national.com/packaging
Power Management	www.national.com/power	Green Compliance	www.national.com/quality/green
Switching Regulators	www.national.com/switchers	Distributors	www.national.com/contacts
LDOs	www.national.com/ldo	Quality and Reliability	www.national.com/quality
LED Lighting	www.national.com/led	Feedback/Support	www.national.com/feedback
Voltage Reference	www.national.com/vref	Design Made Easy	www.national.com/easy
PowerWise® Solutions	www.national.com/powerwise	Solutions	www.national.com/solutions
Serial Digital Interface (SDI)	www.national.com/sdi	Mil/Aero	www.national.com/milaero
Temperature Sensors	www.national.com/tempsensors	SolarMagic™	www.national.com/solarmagic
Wireless (PLL/VCO)	www.national.com/wireless	Analog University®	www.national.com/AU

THE CONTENTS OF THIS DOCUMENT ARE PROVIDED IN CONNECTION WITH NATIONAL SEMICONDUCTOR CORPORATION ("NATIONAL") PRODUCTS. NATIONAL MAKES NO REPRESENTATIONS OR WARRANTIES WITH RESPECT TO THE ACCURACY OR COMPLETENESS OF THE CONTENTS OF THIS PUBLICATION AND RESERVES THE RIGHT TO MAKE CHANGES TO SPECIFICATIONS AND PRODUCT DESCRIPTIONS AT ANY TIME WITHOUT NOTICE. NO LICENSE, WHETHER EXPRESS, IMPLIED, ARISING BY ESTOPPEL OR OTHERWISE, TO ANY INTELLECTUAL PROPERTY RIGHTS IS GRANTED BY THIS DOCUMENT.

TESTING AND OTHER QUALITY CONTROLS ARE USED TO THE EXTENT NATIONAL DEEMS NECESSARY TO SUPPORT NATIONAL'S PRODUCT WARRANTY. EXCEPT WHERE MANDATED BY GOVERNMENT REQUIREMENTS, TESTING OF ALL PARAMETERS OF EACH PRODUCT IS NOT NECESSARILY PERFORMED. NATIONAL ASSUMES NO LIABILITY FOR APPLICATIONS ASSISTANCE OR BUYER PRODUCT DESIGN. BUYERS ARE RESPONSIBLE FOR THEIR PRODUCTS AND APPLICATIONS USING NATIONAL COMPONENTS. PRIOR TO USING OR DISTRIBUTING ANY PRODUCTS THAT INCLUDE NATIONAL COMPONENTS, BUYERS SHOULD PROVIDE ADEQUATE DESIGN, TESTING AND OPERATING SAFEGUARDS.

EXCEPT AS PROVIDED IN NATIONAL'S TERMS AND CONDITIONS OF SALE FOR SUCH PRODUCTS, NATIONAL ASSUMES NO LIABILITY WHATSOEVER, AND NATIONAL DISCLAIMS ANY EXPRESS OR IMPLIED WARRANTY RELATING TO THE SALE AND/OR USE OF NATIONAL PRODUCTS INCLUDING LIABILITY OR WARRANTIES RELATING TO FITNESS FOR A PARTICULAR PURPOSE, MERCHANTABILITY, OR INFRINGEMENT OF ANY PATENT, COPYRIGHT OR OTHER INTELLECTUAL PROPERTY RIGHT.

LIFE SUPPORT POLICY

NATIONAL'S PRODUCTS ARE NOT AUTHORIZED FOR USE AS CRITICAL COMPONENTS IN LIFE SUPPORT DEVICES OR SYSTEMS WITHOUT THE EXPRESS PRIOR WRITTEN APPROVAL OF THE CHIEF EXECUTIVE OFFICER AND GENERAL COUNSEL OF NATIONAL SEMICONDUCTOR CORPORATION. As used herein:

Life support devices or systems are devices which (a) are intended for surgical implant into the body, or (b) support or sustain life and whose failure to perform when properly used in accordance with instructions for use provided in the labeling can be reasonably expected to result in a significant injury to the user. A critical component is any component in a life support device or system whose failure to perform can be reasonably expected to cause the failure of the life support device or system or to affect its safety or effectiveness.

National Semiconductor and the National Semiconductor logo are registered trademarks of National Semiconductor Corporation. All other brand or product names may be trademarks or registered trademarks of their respective holders.

Copyright© 2009 National Semiconductor Corporation

For the most current product information visit us at www.national.com



**National Semiconductor
Americas Technical
Support Center**
Email: support@nsc.com
Tel: 1-800-272-9959

**National Semiconductor Europe
Technical Support Center**
Email: europe.support@nsc.com

**National Semiconductor Asia
Pacific Technical Support Center**
Email: ap.support@nsc.com

**National Semiconductor Japan
Technical Support Center**
Email: jpn.feedback@nsc.com

IMPORTANT NOTICE

Texas Instruments Incorporated and its subsidiaries (TI) reserve the right to make corrections, modifications, enhancements, improvements, and other changes to its products and services at any time and to discontinue any product or service without notice. Customers should obtain the latest relevant information before placing orders and should verify that such information is current and complete. All products are sold subject to TI's terms and conditions of sale supplied at the time of order acknowledgment.

TI warrants performance of its hardware products to the specifications applicable at the time of sale in accordance with TI's standard warranty. Testing and other quality control techniques are used to the extent TI deems necessary to support this warranty. Except where mandated by government requirements, testing of all parameters of each product is not necessarily performed.

TI assumes no liability for applications assistance or customer product design. Customers are responsible for their products and applications using TI components. To minimize the risks associated with customer products and applications, customers should provide adequate design and operating safeguards.

TI does not warrant or represent that any license, either express or implied, is granted under any TI patent right, copyright, mask work right, or other TI intellectual property right relating to any combination, machine, or process in which TI products or services are used. Information published by TI regarding third-party products or services does not constitute a license from TI to use such products or services or a warranty or endorsement thereof. Use of such information may require a license from a third party under the patents or other intellectual property of the third party, or a license from TI under the patents or other intellectual property of TI.

Reproduction of TI information in TI data books or data sheets is permissible only if reproduction is without alteration and is accompanied by all associated warranties, conditions, limitations, and notices. Reproduction of this information with alteration is an unfair and deceptive business practice. TI is not responsible or liable for such altered documentation. Information of third parties may be subject to additional restrictions.

Resale of TI products or services with statements different from or beyond the parameters stated by TI for that product or service voids all express and any implied warranties for the associated TI product or service and is an unfair and deceptive business practice. TI is not responsible or liable for any such statements.

TI products are not authorized for use in safety-critical applications (such as life support) where a failure of the TI product would reasonably be expected to cause severe personal injury or death, unless officers of the parties have executed an agreement specifically governing such use. Buyers represent that they have all necessary expertise in the safety and regulatory ramifications of their applications, and acknowledge and agree that they are solely responsible for all legal, regulatory and safety-related requirements concerning their products and any use of TI products in such safety-critical applications, notwithstanding any applications-related information or support that may be provided by TI. Further, Buyers must fully indemnify TI and its representatives against any damages arising out of the use of TI products in such safety-critical applications.

TI products are neither designed nor intended for use in military/aerospace applications or environments unless the TI products are specifically designated by TI as military-grade or "enhanced plastic." Only products designated by TI as military-grade meet military specifications. Buyers acknowledge and agree that any such use of TI products which TI has not designated as military-grade is solely at the Buyer's risk, and that they are solely responsible for compliance with all legal and regulatory requirements in connection with such use.

TI products are neither designed nor intended for use in automotive applications or environments unless the specific TI products are designated by TI as compliant with ISO/TS 16949 requirements. Buyers acknowledge and agree that, if they use any non-designated products in automotive applications, TI will not be responsible for any failure to meet such requirements.

Following are URLs where you can obtain information on other Texas Instruments products and application solutions:

Products

Audio	www.ti.com/audio
Amplifiers	amplifier.ti.com
Data Converters	dataconverter.ti.com
DLP® Products	www.dlp.com
DSP	dsp.ti.com
Clocks and Timers	www.ti.com/clocks
Interface	interface.ti.com
Logic	logic.ti.com
Power Mgmt	power.ti.com
Microcontrollers	microcontroller.ti.com
RFID	www.ti-rfid.com
OMAP Mobile Processors	www.ti.com/omap
Wireless Connectivity	www.ti.com/wirelessconnectivity

Applications

Communications and Telecom	www.ti.com/communications
Computers and Peripherals	www.ti.com/computers
Consumer Electronics	www.ti.com/consumer-apps
Energy and Lighting	www.ti.com/energy
Industrial	www.ti.com/industrial
Medical	www.ti.com/medical
Security	www.ti.com/security
Space, Avionics and Defense	www.ti.com/space-avionics-defense
Transportation and Automotive	www.ti.com/automotive
Video and Imaging	www.ti.com/video

TI E2E Community Home Page

e2e.ti.com

Mailing Address: Texas Instruments, Post Office Box 655303, Dallas, Texas 75265
Copyright © 2011, Texas Instruments Incorporated