

## LM48555 Boomer® Audio Power Amplifier Series Ceramic Speaker Driver

Check for Samples: [LM48555](#)

### FEATURES

- Fully Differential Amplifier
- Externally Configurable Gain
- Soft Start Function
- Low Power Shutdown Mode
- Under Voltage Lockout

### APPLICATIONS

- Mobile Phones
- PDA's
- Digital Cameras

### KEY SPECIFICATIONS

- **IDDQ (Boost Converter + Amplifier) at VDD = 5V: 7.5mA (typ)**
- **Output Voltage Swing VDD = 3.2V, THD ≤ 1%: 15.7V<sub>P-P</sub> (typ)**
- **Power Supply Rejection Ratio f = 217Hz 80dB (typ)**

### DESCRIPTION

The LM48555 is an audio power amplifier designed to drive ceramic speakers in applications such as cell phones, smart phones, PDAs and other portable devices. The LM48555 produces 15.7V<sub>P-P</sub> with less than 1% THD+N while operating from a 3.2V power supply. The LM48555 features a low power shutdown mode, and differential inputs for improved noise rejection.

The LM48555 includes advanced click and pop suppression that eliminates audible turn-on and turn-off transients. Additionally, the integrated boost regulator features a soft start function that minimizes transient current during power-up.

Boomer audio power amplifiers were designed specifically to provide high quality output power with a minimal number of external components. The LM48555 does not require bootstrap capacitors, or snubber circuits.

The LM48555 is unity-gain stable and uses external gain-setting resistors.



Please be aware that an important notice concerning availability, standard warranty, and use in critical applications of Texas Instruments semiconductor products and disclaimers thereto appears at the end of this data sheet.

All trademarks are the property of their respective owners.

Typical Application

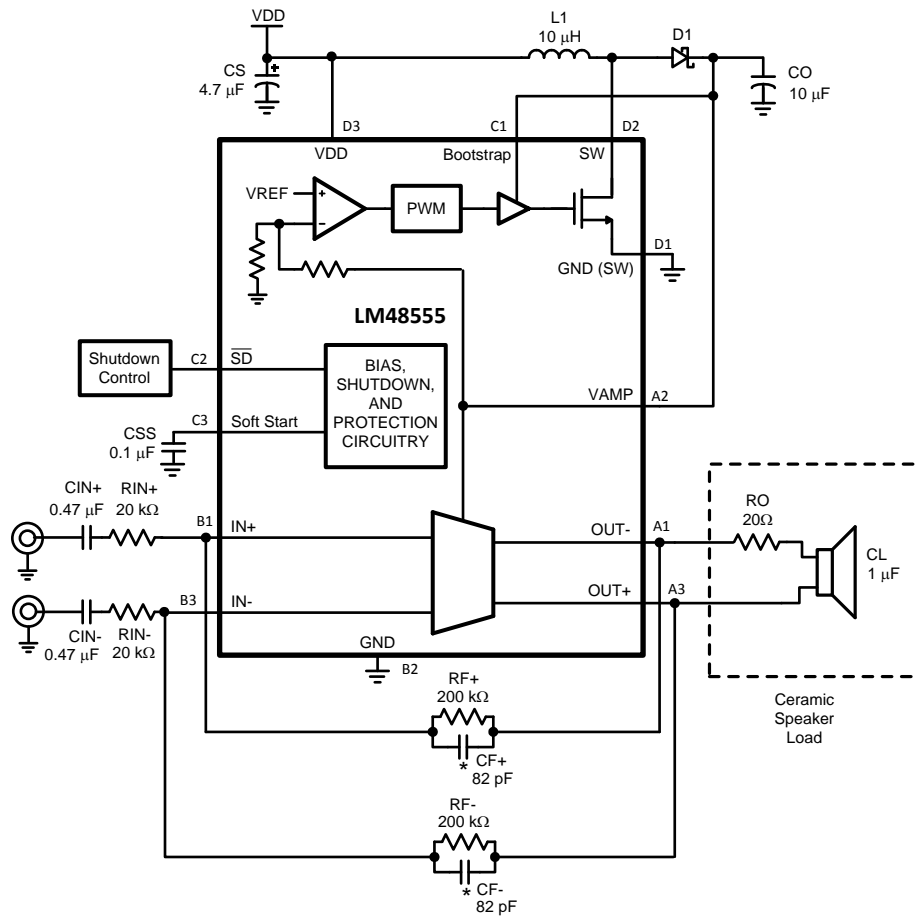

\* CF+ and CF- are optional. Refer to “SELECTING INPUT AND FEEDBACK CAPACITORS AND RESISTOR FOR AUDIO AMPLIFIER” section.

Figure 1. Typical Audio Amplifier Application Circuit

## Connection Diagram

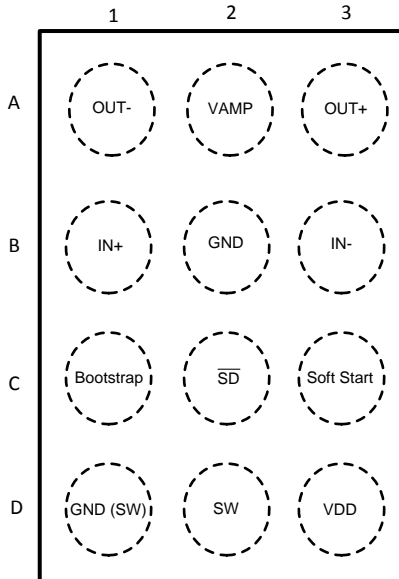

**Figure 2. Top View  
LM48555TL Bumps Down View  
Package Number YZR0012Z1A**

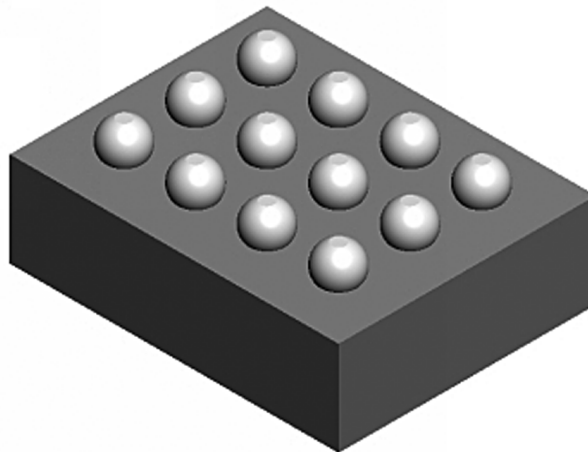

**Figure 3. YZR0012 Package View (Bumps Up)**



These devices have limited built-in ESD protection. The leads should be shorted together or the device placed in conductive foam during storage or handling to prevent electrostatic damage to the MOS gates.

### Absolute Maximum Ratings<sup>(1)(2)(3)</sup>

|                                   |                              |                          |
|-----------------------------------|------------------------------|--------------------------|
| Supply Voltage ( $V_{DD}$ )       |                              | 9.5V                     |
| Storage Temperature               |                              | -65°C to +150°C          |
| Input Voltage                     |                              | -0.3V to $V_{DD} + 0.3V$ |
| Power Dissipation <sup>(4)</sup>  |                              | Internally limited       |
| ESD Susceptibility <sup>(5)</sup> |                              | 2000V                    |
| ESD Susceptibility <sup>(6)</sup> |                              | 200V                     |
| Junction Temperature              |                              | 150°C                    |
| Thermal Resistance                | $\theta_{JA}$ <sup>(7)</sup> | 114°C/W                  |

- (1) All voltages are measured with respect to the GND pin, unless otherwise specified.
- (2) *Absolute Maximum Ratings* indicate limits beyond which damage to the device may occur. *Operating Ratings* indicate conditions for which the device is functional, but do not ensure specific performance limits. *Electrical Characteristics* state DC and AC electrical specifications under particular test conditions which ensure specific performance limits. This assumes that the device is within the Operating Ratings. Specifications are not ensured for parameters where no limit is given, however, the typical value is a good indication of device performance.
- (3) If Military/Aerospace specified devices are required, please contact the Texas Instruments Sales Office/ Distributors for availability and specifications.
- (4) The maximum power dissipation must be derated at elevated temperatures and is dictated by  $T_{JMAX}$ ,  $\theta_{JA}$ , and the ambient temperature,  $T_A$ . The maximum allowable power dissipation is  $P_{DMAX} = (T_{JMAX} - T_A) / \theta_{JA}$  or the given in Absolute Maximum Ratings, whichever is lower.
- (5) Human body model, 100pF discharged through a 1.5k $\Omega$  resistor.
- (6) Machine Model, 220pF–240pF discharged through all pins.
- (7) The value for  $\theta_{JA}$  is measured with the LM48555 mounted on a 3" x 1.5" (76.2mm x 3.81mm) four layer board. The copper thickness for all four layers is 0.5oz (roughly 0.18mm).

### Operating Ratings

|                             |  |                              |
|-----------------------------|--|------------------------------|
| Temperature Range           | $T_{MIN} \leq T_A \leq T_{MAX}$ <sup>(1)</sup> | -40°C $\leq T_A \leq$ +85°C  |
| Supply Voltage ( $V_{DD}$ ) |  | 2.7V $\leq V_{DD} \leq$ 6.5V |

- (1) The value for  $\theta_{JA}$  is measured with the LM48555 mounted on a 3" x 1.5" (76.2mm x 3.81mm) four layer board. The copper thickness for all four layers is 0.5oz (roughly 0.18mm).

### Electrical Characteristics<sup>(1)(2)</sup>

The following specifications apply for  $V_{DD} = 3.2V$  and the conditions shown in "Typical Audio Amplifier Application Circuit" (see [Figure 1](#)), unless otherwise specified. Limits apply for  $T_A = 25^\circ C$ .

| Symbol         | Parameter   | Conditions                           | LM48555                |                          | Units (Limits)   |
|----------------|---|--------------------------------------|------------------------|--------------------------|------------------|
|                |   |                                      | Typical <sup>(3)</sup> | Limit <sup>(4) (5)</sup> |                  |
| $I_{DD}$       | Quiescent Power Supply Current in Boosted Ringer Mode | $V_{IN} = 0V$ , No Load              |                        |                          |                  |
|                |   | $V_{DD} = 5.0V$                      | 7.5                    |                          | mA               |
|                |   | $V_{DD} = 3.6V$                      | 10                     |                          | mA               |
|                |   | $V_{DD} = 3.2V$                      | 12                     | 15                       | mA (max)         |
| $I_{SD}$       | Shutdown Current                                      | $\overline{SD} = GND$ <sup>(6)</sup> | 0.1                    | 1                        | $\mu A$ (max)    |
| $V_{LH}$       | Logic High Threshold Voltage                          |                                      |                        | 1.2                      | V (min)          |
| $V_{LL}$       | Logic Low Threshold Voltage                           |                                      |                        | 0.4                      | V (max)          |
| $R_{PULLDOWN}$ | Pulldown Resistor on $\overline{SD}$ pin              |                                      | 80                     | 53                       | k $\Omega$ (min) |
| $T_{WU}$       | Wake-up Time  | $CSS = 0.1\mu F$                     | 100                    |                          | ms               |
| $V_{AMP}$      | Boost Converter Output Voltage                        | Voltage on $V_{AMP}$ Pin             | 8                      | 8.5                      | V (max)          |
|                |   |                                      |                        | 7.5                      | V (min)          |

- (1) All voltages are measured with respect to the GND pin, unless otherwise specified.
- (2) *Absolute Maximum Ratings* indicate limits beyond which damage to the device may occur. *Operating Ratings* indicate conditions for which the device is functional, but do not ensure specific performance limits. *Electrical Characteristics* state DC and AC electrical specifications under particular test conditions which ensure specific performance limits. This assumes that the device is within the Operating Ratings. Specifications are not ensured for parameters where no limit is given, however, the typical value is a good indication of device performance.
- (3) Typical values are measured at 25°C and represent the parametric norm.
- (4) Limits are specified to AOQL (Average Outgoing Quality Level).
- (5) Datasheet min/max specification limits are specified by design, test, or statistical analysis.
- (6) Shutdown current is measured in a normal room environment. The SD pin should be driven as close as possible to GND for minimum shutdown current.

**Electrical Characteristics<sup>(1)(2)</sup> (continued)**

The following specifications apply for  $V_{DD} = 3.2V$  and the conditions shown in “*Typical Audio Amplifier Application Circuit*” (see [Figure 1](#)), unless otherwise specified. Limits apply for  $T_A = 25^\circ C$ .

| Symbol          | Parameter                         | Conditions   | LM48555                |                          | Units (Limits)  |
|-----------------|-----------------------------------|--|------------------------|--------------------------|-----------------|
|                 |                                   |  | Typical <sup>(3)</sup> | Limit <sup>(4) (5)</sup> |                 |
| $V_{OUT}$       | Output Voltage Swing              | THD = 1% (max); f = 1kHz                             | 15.7                   | 15                       | $V_{P-P}$ (min) |
| THD+N           | Total Harmonic Distortion + Noise | $V_{OUT} = 14V_{P-P}$ , f = 1kHz                     | 0.05                   | 0.5                      | % (max)         |
| $\epsilon_{OS}$ | Output Noise                      | A-Weighted Filter, $V_{IN} = 0V$                     | 70                     |                          | $\mu V$         |
| PSRR            | Power Supply Rejection Ratio      | $V_{RIPPLE} = 200mV_{P-P}$ , f = 217Hz, $A_V = 20dB$ | 80                     | 72                       | dB (min)        |
| $I_{SW}$        | Switch Current Limit              |  | 2                      |                          | A               |
| $V_{OS}$        | Output Offset Voltage             |  | 0.5                    | 4.5                      | mV (max)        |
| CMRR            | Common Mode Rejection Ratio       | Input referred                                       | 70                     | 65                       | dB (min)        |
| UVLO            | Under-Voltage Lock Out            |  | 2.5                    | 2.6                      | V (max)         |
| $R_{DS(ON)}$    | Switch ON resistance              |  | 0.3                    |                          | $\Omega$        |

### Typical Performance Characteristics

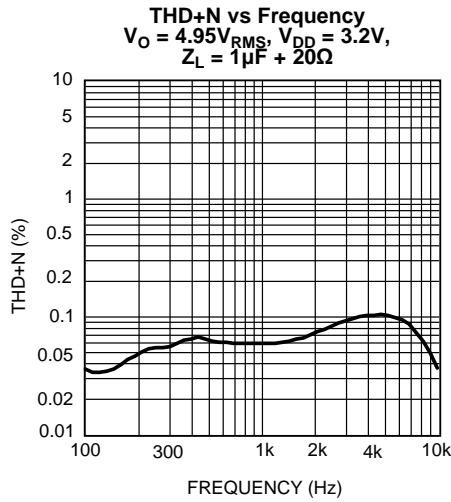

Figure 4.

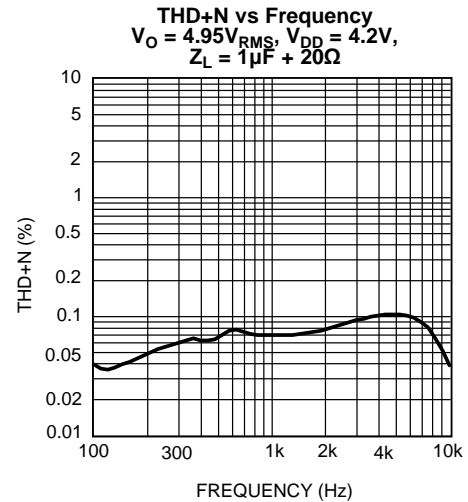

Figure 5.

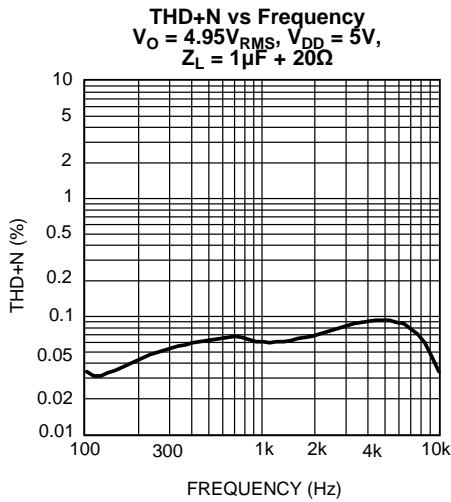

Figure 6.

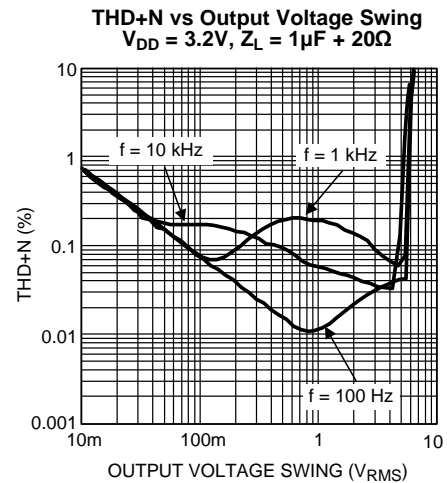

Figure 7.

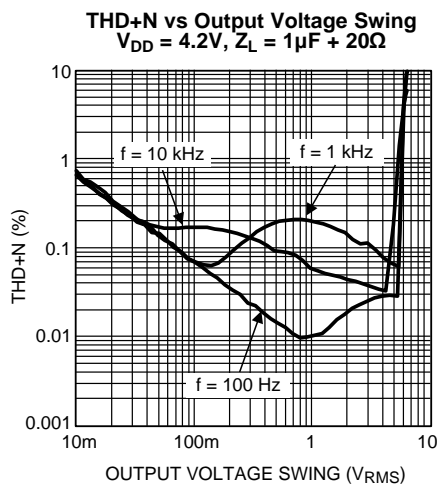

Figure 8.

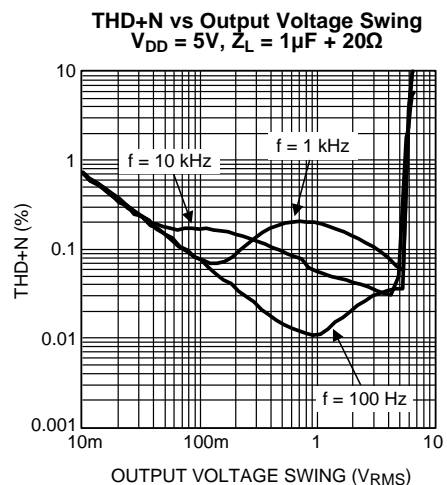

Figure 9.

Typical Performance Characteristics (continued)

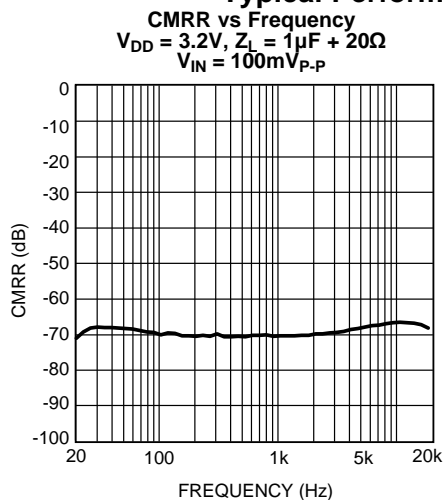

Figure 10.

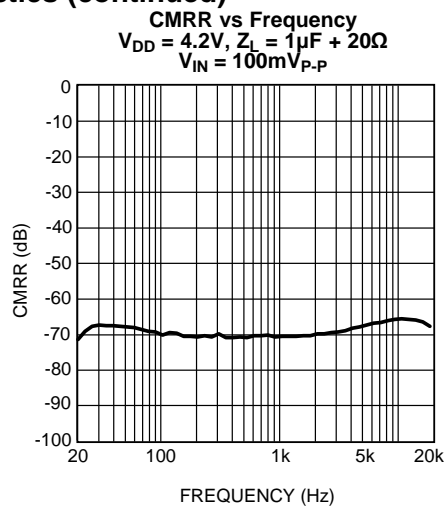

Figure 11.

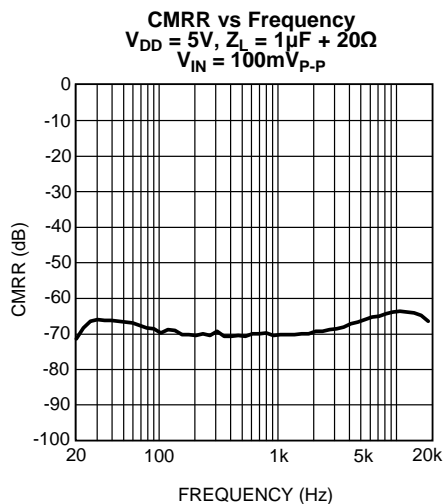

Figure 12.

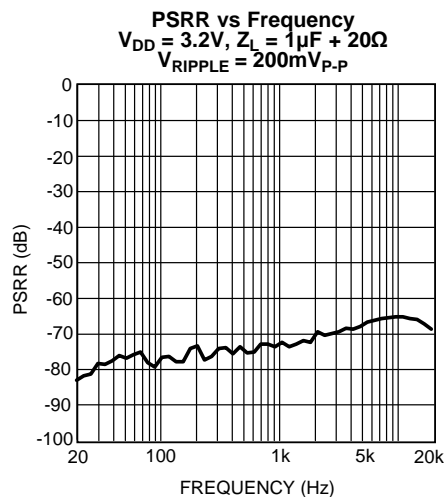

Figure 13.

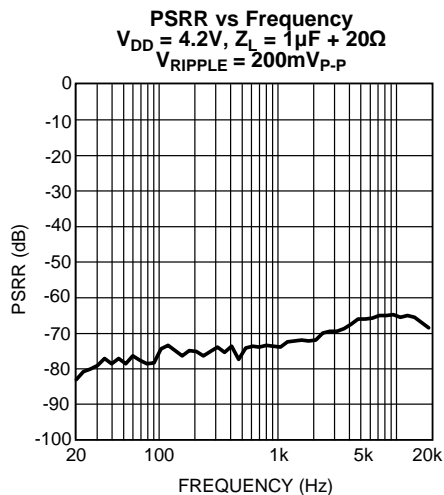

Figure 14.

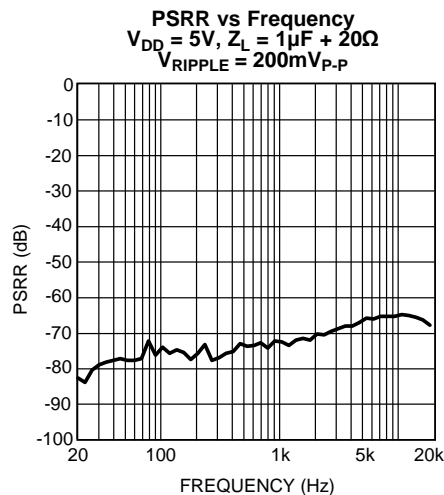

Figure 15.

**Typical Performance Characteristics (continued)**

**Inductor Current vs Output Voltage Swing**  
 $Z_L = 1\mu F + 20\Omega$ ,  $f = 1\text{kHz}$ ,  
 $V_{DD} = 3\text{V}, 4.2\text{V}, 5\text{V}$

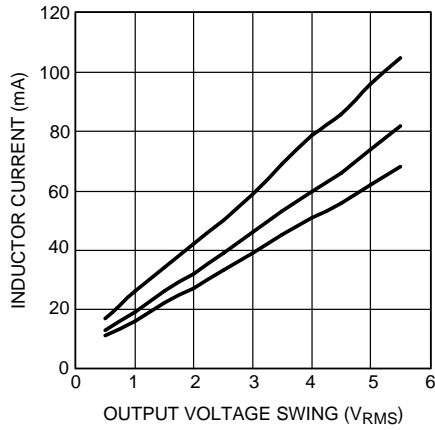

Figure 16.

**Supply Current vs Supply Voltage**

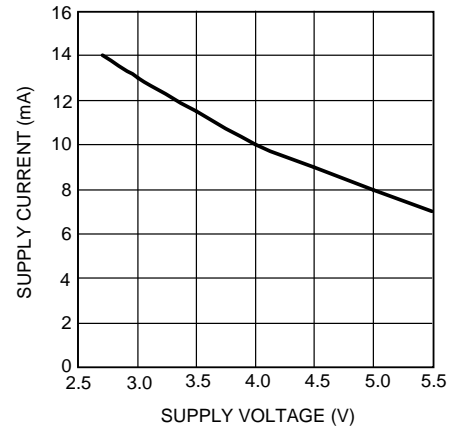

Figure 17.



## APPLICATION INFORMATION

### CHARACTERISTICS OF CERAMIC SPEAKERS

Because of their ultra-thin profile piezoelectric ceramic speakers are ideal for portable applications. Piezoelectric materials have high dielectric constants and their component electrical property is like a capacitor. Therefore, piezoelectric ceramic speakers essentially represent capacitive loads over frequency. Because these speakers are capacitive rather than resistive, they require less current than traditional moving coil speakers. However, ceramic speakers require high driving voltages (approximately 15V<sub>P-P</sub>). To achieve these high output voltages in battery operated applications, the LM48555 integrates a boost converter with an audio amplifier. High quality piezoelectric ceramic speakers are manufactured by TayioYuden ([www.t-yuden.com](http://www.t-yuden.com)). Tayio Yuden's MLS-A Series Ceramic Speaker series is recommended.

### DIFFERENTIAL AMPLIFIER EXPLANATION

The LM48555 includes a fully differential audio amplifier that features differential input and output stages. Internally this is accomplished by two circuits: a differential amplifier and a common mode feedback amplifier that adjusts the output voltages so that the average value remains  $V_{DD}/2$ . When setting the differential gain, the amplifier can be considered to have "halves". Each half uses an input and feedback resistor (RIN<sub>-</sub> and RF<sub>-</sub>) to set its respective closed-loop gain (see [Figure 1](#)). With RIN<sub>+</sub> = RIN<sub>-</sub> and RF<sub>+</sub> = RF<sub>-</sub>, the gain is set at -RF/RIN for each half. This results in a differential gain of

$$A_{VD} = -RF/RIN \quad (1)$$

It is extremely important to match the input resistors, as well as the feedback resistors to each other for best amplifier performance. A differential amplifier works in a manner where the difference between the two input signals is amplified. In most applications, this would require input signals that are 180° out of phase with each other. The LM48555 can be used, however, as a single-ended input amplifier while still retaining its fully differential benefits. In fact, completely unrelated signals may be placed at the input pins. The LM48555 simply amplifies the difference between them.

The LM48555 provides what is known as a "bridged mode" output (bridge-tied-load, BTL). This results in output signals at OUT<sub>+</sub> and OUT<sub>-</sub> that are 180° out of phase with respect to each other. Bridged mode operation is different from the traditional single-ended amplifier configuration that connects the load between the amplifier output and ground. A bridged amplifier design has advantages over the single-ended configuration: it provides differential drive to the load, thus doubling maximum possible output swing for a specific supply voltage. Up to four times the output power is possible compared with a single-ended amplifier under the same conditions.

A bridged configuration, such as the one used in the LM48555, also creates a second advantage over single-ended amplifiers. Since the differential outputs, OUT<sub>+</sub> and OUT<sub>-</sub>, are biased at half-supply, no net DC voltage exists across the load. This assumes that the input resistor pair and the feedback resistor pair are properly matched. BTL configuration eliminates the output coupling capacitor required in single supply, single-ended amplifier configurations. If an output coupling capacitor is not used in a single-ended output configuration, the half-supply bias across the load would result in both increased internal IC power dissipation as well as permanent loudspeaker damage.

### BOOST CONVERTER POWER DISSIPATION

At higher duty cycles, the increased ON-time of the switch FET means the maximum output current will be determined by power dissipation within the LM48555 FET switch. The switch power dissipation from ON-time conduction is calculated by [Equation 2](#).

$$P_{D(SWITCH)} = DC \times (I_{INDUCTOR(AVE)})^2 \times R_{DS(ON)} \text{ (W)}$$

where

- DC is the duty cycle (2)

There will be some switching losses in addition to the power loss calculated in [Equation 2](#), so some derating needs to be applied when calculating IC power dissipation. See "[MAXIMUM TOTAL POWER DISSIPATION](#)" section.

## MAXIMUM AMPLIFIER POWER DISSIPATION

Power dissipation is a major concern when designing a successful amplifier, whether the amplifier is bridged or single-ended. A direct consequence of the increased power delivered to the load by a bridge amplifier is an increase in internal power dissipation. Since the amplifier portion of the LM48555 has two operational amplifiers, the maximum internal power dissipation is 4 times that of a single-ended amplifier. The maximum power dissipation for a given BTL application can be derived from [Equation 3](#).

$$P_{\text{DMAX(AMP)}} = (2V_{\text{DD}}^2) / (\pi^2 \text{RO}) \text{ (W)} \quad (3)$$

## MAXIMUM TOTAL POWER DISSIPATION

The total power dissipation for the LM48555 can be calculated by adding [Equation 2](#) and [Equation 3](#) together to establish [Equation 4](#):

$$P_{\text{DMAX(TOTAL)}} = (2V_{\text{DD}}^2) / (\pi^2 \text{EFF}^2 \text{RO}) \text{ (W)}$$

where

- EFF = Efficiency of boost converter (4)

The result from [Equation 4](#) must not be greater than the power dissipation that results from [Equation 5](#):

$$P_{\text{DMAX}} = (T_{\text{JMAX}} - T_{\text{A}}) / \theta_{\text{JA}} \text{ (W)} \quad (5)$$

For the YZR0012Z1A,  $\theta_{\text{JA}} = 114^\circ\text{C/W}$ .  $T_{\text{JMAX}} = 150^\circ\text{C}$  for the LM48555. Depending on the ambient temperature,  $T_{\text{A}}$ , of the system surroundings, [Equation 5](#) can be used to find the maximum internal power dissipation supported by the IC packaging. If the result of [Equation 4](#) is greater than that of [Equation 5](#), then either the supply voltage must be decreased, the load impedance increased or  $T_{\text{A}}$  reduced. For typical applications, power dissipation is not an issue. Power dissipation is a function of output power and thus, if typical operation is not around the maximum power dissipation point, the ambient temperature may be increased accordingly.

## STARTUP SEQUENCE

Correct startup sequencing is important for optimal device performance. Using the correct startup sequence will improve click and pop performance as well as avoid transients that could reduce battery life. The device should be in Shutdown mode when the supply voltage is applied. Once the supply voltage has been supplied the device can be released from Shutdown mode.

## SHUTDOWN FUNCTION

In many applications, a microcontroller or microprocessor output is used to control the shutdown circuitry to provide a quick, smooth transition into shutdown. Another solution is to use a single-pole, single-throw switch connected between  $V_{\text{DD}}$  and Shutdown pins.

## BOOTSTRAP PIN

The bootstrap pin provides a voltage supply for the internal switch driver. Connecting the bootstrap pin to VAMP (See [Figure 1](#)) allows for a higher voltage to drive the gate of the switch thereby reducing the  $R_{\text{DS(ON)}}$ . This configuration is necessary in applications with heavier loads. The bootstrap pin can be connected to  $V_{\text{DD}}$  when driving lighter loads to improve device performance ( $I_{\text{DD}}$ , THD+N, Noise, etc.).

## PROPER SELECTION OF EXTERNAL COMPONENTS

Proper selection of external components in applications using integrated power amplifiers, and switching DC-DC converters, is critical for optimizing device and system performance. Consideration to component values must be used to maximize overall system quality. The best capacitors for use with the switching converter portion of the LM48555 are multi-layer ceramic capacitors. They have the lowest ESR (equivalent series resistance) and highest resonance frequency, which makes them optimum for high frequency switching converters. When selecting a ceramic capacitor, only X5R and X7R dielectric types should be used. Other types such as Z5U and Y5F have such severe loss of capacitance due to effects of temperature variation and applied voltage, they may provide as little as 20% of rated capacitance in many typical applications. Always consult capacitor manufacturer's data curves before selecting a capacitor. High-quality ceramic capacitors can be obtained from Taiyo-Yuden and Murata.

## POWER SUPPLY BYPASSING

As with any amplifier, proper supply bypassing is critical for low noise performance and high power supply rejection. The capacitor location on both V1 and V<sub>DD</sub> pins should be as close to the device as possible.

## SELECTING INPUT AND FEEDBACK CAPACITORS AND RESISTOR FOR AUDIO AMPLIFIER

Special care must be taken to match the values of the feedback resistors (RF+ and RF-) to each other as well as matching the input resistors (RIN+ and RIN-) to each other (see [Typical Application](#)). Because of the balanced nature of differential amplifiers, resistor matching differences can result in net DC currents across the load. This DC current can increase power consumption, internal IC power dissipation, reduce PSRR, and possibly damage the loudspeaker. To achieve best performance with minimum component count, it is highly recommended that both the feedback and input resistors match to 1% tolerance or better.

The input coupling capacitors, CIN, forms a first order high pass filter which limits low frequency response. This value should be chosen based on needed frequency response. High value input capacitors are both expensive and space hungry in portable designs. A certain value capacitor is needed to couple in low frequencies without severe attenuation. Ceramic speakers used in portable systems, whether internal or external, have little ability to reproduce signals below 100Hz to 150Hz. Thus, using a high value input capacitor may not increase actual system performance. In addition to system cost and size, click and pop performance is affected by the value of the input coupling capacitor, CIN. A high value input coupling capacitor requires more charge to reach its quiescent DC voltage (nominally 1/2 V<sub>DD</sub>). This charge comes from the output via the feedback and is apt to create pops upon device enable. Thus, by minimizing the capacitor value based on desired low frequency response, turn-on pops can be minimized.

The LM48555 is unity-gain stable which gives the designer maximum system flexibility. However, to drive ceramic speakers, a typical application requires a closed-loop differential gain of 10V/V. In this case, feedback capacitors (CF+, CF-) may be needed as shown in [Figure 1](#) to bandwidth limit the amplifier. If the available input signal is bandwidth limited, then capacitors CF+ and CF- can be eliminated. These feedback capacitors create a low pass filter that eliminates possible high frequency noise. Care should be taken when calculating the -3dB frequency (from [Equation 6](#)) because an incorrect combination of RF and CF will cause rolloff before the desired frequency.

$$f_{-3dB} = 1 / 2\pi RF * CF \quad (6)$$

## SELECTING OUTPUT CAPACITOR (CO) FOR BOOST CONVERTER

A single 4.7µF to 10µF ceramic capacitor will provide sufficient output capacitance for most applications. If larger amounts of capacitance are desired for improved line support and transient response, tantalum capacitors can be used. Aluminum electrolytics with ultra low ESR such as Sanyo Oscon can be used. Typical electrolytic capacitors are not suitable for switching frequencies above 500 kHz because of significant ringing and temperature rise due to self-heating from ripple current. An output capacitor with excessive ESR can also reduce phase margin and cause instability. In general, if electrolytics are used, it is recommended that they be paralleled with ceramic capacitors to reduce ringing, switching losses, and output voltage ripple.

## SELECTING A POWER SUPPLY BYPASS CAPACITOR

A supply bypass capacitor is required to serve as an energy reservoir for the current which must flow into the coil each time the switch turns on. This capacitor must have extremely low ESR, so ceramic capacitors are the best choice. A nominal value of 4.7µF is recommended, but larger values can be used. Since this capacitor reduces the amount of voltage ripple seen at the input pin, it also reduces the amount of EMI passed back along that line to other circuitry.

## SELECTING A SOFT-START CAPACITOR (CSS)

The soft-start function charges the boost converter reference voltage slowly. This allows the output of the boost converter to ramp up slowly thus limiting the transient current at startup. Selecting a soft-start capacitor (CSS) value presents a trade off between the wake-up time and the startup transient current. Using a larger capacitor value will increase wake-up time and decrease startup transient current while the apposite effect happens with a smaller capacitor value. A general guideline is to use a capacitor value 1000 times smaller than the output capacitance of the boost converter (CO). A 0.1µF soft-start capacitor is recommended for a typical application.

## SELECTING DIODES

The external diode used in [Figure 1](#) should be a Schottky diode. A 20V diode such as the MBR0520 from Fairchild Semiconductor or ON Semiconductor is recommended. The MBR05XX series of diodes are designed to handle a maximum average current of 0.5A. For applications exceeding 0.5A average but less than 1A, a Microsemi UPS5817 can be used.

## OUTPUT VOLTAGE OF BOOST CONVERTER

The output voltage is set using two internal resistors. The output voltage of the boost converter is set to 8V (typ).

## DUTY CYCLE

The maximum duty cycle of the boost converter determines the maximum boost ratio of output-to-input voltage that the converter can attain in continuous mode of operation. The duty cycle for a given boost application is defined by [Equation 7](#):

$$\text{Duty Cycle} = (V_{\text{AMP}} + V_{\text{DIODE}} - V_{\text{DD}}) / (V_{\text{AMP}} + V_{\text{DIODE}} - V_{\text{SW}}) \quad (7)$$

This applies for continuous mode operation.

## INDUCTANCE VALUE

Inductor value involves trade-offs in performance. Larger inductors reduce inductor ripple current, which typically means less output voltage ripple (for a given size of output capacitor). Larger inductors also mean more load power can be delivered because the energy stored during each switching cycle is:

$$E = L/2 \times I_p^2$$

where

- “ $I_p$ ” is the peak inductor current (8)

The LM48555 will limit its switch current based on peak current. With  $I_p$  fixed, increasing L will increase the maximum amount of power available to the load. Conversely, using too little inductance may limit the amount of load current which can be drawn from the output. Best performance is usually obtained when the converter is operated in “continuous” mode at the load current range of interest, typically giving better load regulation and less output ripple. Continuous operation is defined as not allowing the inductor current to drop to zero during the cycle. Boost converters shift over to discontinuous operation if the load is reduced far enough, but a larger inductor stays continuous over a wider load current range.

## INDUCTOR SUPPLIERS

The recommended inductors for the LM48555 are the Taiyo-Yuden NR4012, NR3010, and CBC3225 series and Murata's LQH3NPN series. When selecting an inductor, the continuous current rating must be high enough to avoid saturation at peak currents. A suitable core type must be used to minimize core (switching) losses, and wire power losses must be considered when selecting the current rating.

## CALCULATING OUTPUT CURRENT OF BOOST CONVERTER ( $I_{\text{AMP}}$ )

The load current of the boost converter is related to the average inductor current by the relation:

$$I_{\text{AMP}} = I_{\text{INDUCTOR(AVE)}} \times (1 - \text{DC}) \quad (\text{A})$$

where

- “DC” is the duty cycle of the application (9)

The switch current can be found by:

$$I_{\text{SW}} = I_{\text{INDUCTOR(AVE)}} + 1/2 (I_{\text{RIPPLE}}) \quad (\text{A}) \quad (10)$$

Inductor ripple current is dependent on inductance, duty cycle, supply voltage and frequency:

$$I_{\text{RIPPLE}} = \text{DC} \times (V_{\text{DD}} - V_{\text{SW}}) / (f \times$$

where

- $f$  = switching frequency = 1MHzL) (A) (11)

combining all terms, we can develop an expression which allows the maximum available load current to be calculated:

$$I_{AMP(max)} = (1-DC) \times [I_{SW(max)} - DC(V-V_{SW})] / 2fL \text{ (A)} \quad (12)$$

The equation shown to calculate maximum load current takes into account the losses in the inductor or turn-off switching losses of the FET and diode.

### DESIGN PARAMETERS $V_{SW}$ AND $I_{SW}$

The value of the FET "ON" voltage (referred to as  $V_{SW}$  in [Equation 9](#) thru [Equation 12](#)) is dependent on load current. A good approximation can be obtained by multiplying the on resistance ( $R_{DS(ON)}$ ) of the FET times the average inductor current. The maximum peak switch current the device can deliver is dependent on duty cycle.

### EVALUATION BOARD AND PCB LAYOUT GUIDELINES

For information on the LM48555 demo board and PCB layout guidelines refer to Application Notes AN-1611 (Literature Number [SNAA041](#)).

### Revision History

| Rev  | Date       | Description  |
|------|------------|--|
| 1.0  | 03/15/07   | Initial Web Release.   |
| 1.01 | 07/27/12   | Deleted the Murata references on <a href="#">Application Information</a> . |
| B    | 05/02/2013 | Changed layout of National Data Sheet to TI format.                        |

**PACKAGING INFORMATION**

| Orderable Device | Status<br>(1) | Package Type | Package Drawing | Pins | Package Qty | Eco Plan<br>(2) | Lead/Ball Finish<br>(6) | MSL Peak Temp<br>(3) | Op Temp (°C) | Device Marking<br>(4/5) | Samples |
|------------------|---------------|--------------|-----------------|------|-------------|-----------------|-------------------------|----------------------|--------------|-------------------------|---------|
| LM48555TL/NOPB   | ACTIVE        | DSBGA        | YZR             | 12   |             | TBD             | Call TI                 | Call TI              | -40 to 85    | G<br>I4                 | Samples |

(1) The marketing status values are defined as follows:

**ACTIVE:** Product device recommended for new designs.

**LIFEBUY:** TI has announced that the device will be discontinued, and a lifetime-buy period is in effect.

**NRND:** Not recommended for new designs. Device is in production to support existing customers, but TI does not recommend using this part in a new design.

**PREVIEW:** Device has been announced but is not in production. Samples may or may not be available.

**OBSELETE:** TI has discontinued the production of the device.

(2) Eco Plan - The planned eco-friendly classification: Pb-Free (RoHS), Pb-Free (RoHS Exempt), or Green (RoHS & no Sb/Br) - please check <http://www.ti.com/productcontent> for the latest availability information and additional product content details.

**TBD:** The Pb-Free/Green conversion plan has not been defined.

**Pb-Free (RoHS):** TI's terms "Lead-Free" or "Pb-Free" mean semiconductor products that are compatible with the current RoHS requirements for all 6 substances, including the requirement that lead not exceed 0.1% by weight in homogeneous materials. Where designed to be soldered at high temperatures, TI Pb-Free products are suitable for use in specified lead-free processes.

**Pb-Free (RoHS Exempt):** This component has a RoHS exemption for either 1) lead-based flip-chip solder bumps used between the die and package, or 2) lead-based die adhesive used between the die and leadframe. The component is otherwise considered Pb-Free (RoHS compatible) as defined above.

**Green (RoHS & no Sb/Br):** TI defines "Green" to mean Pb-Free (RoHS compatible), and free of Bromine (Br) and Antimony (Sb) based flame retardants (Br or Sb do not exceed 0.1% by weight in homogeneous material)

(3) MSL, Peak Temp. - The Moisture Sensitivity Level rating according to the JEDEC industry standard classifications, and peak solder temperature.

(4) There may be additional marking, which relates to the logo, the lot trace code information, or the environmental category on the device.

(5) Multiple Device Markings will be inside parentheses. Only one Device Marking contained in parentheses and separated by a "~" will appear on a device. If a line is indented then it is a continuation of the previous line and the two combined represent the entire Device Marking for that device.

(6) Lead/Ball Finish - Orderable Devices may have multiple material finish options. Finish options are separated by a vertical ruled line. Lead/Ball Finish values may wrap to two lines if the finish value exceeds the maximum column width.

**Important Information and Disclaimer:**The information provided on this page represents TI's knowledge and belief as of the date that it is provided. TI bases its knowledge and belief on information provided by third parties, and makes no representation or warranty as to the accuracy of such information. Efforts are underway to better integrate information from third parties. TI has taken and continues to take reasonable steps to provide representative and accurate information but may not have conducted destructive testing or chemical analysis on incoming materials and chemicals. TI and TI suppliers consider certain information to be proprietary, and thus CAS numbers and other limited information may not be available for release.

In no event shall TI's liability arising out of such information exceed the total purchase price of the TI part(s) at issue in this document sold by TI to Customer on an annual basis.



YZR0012

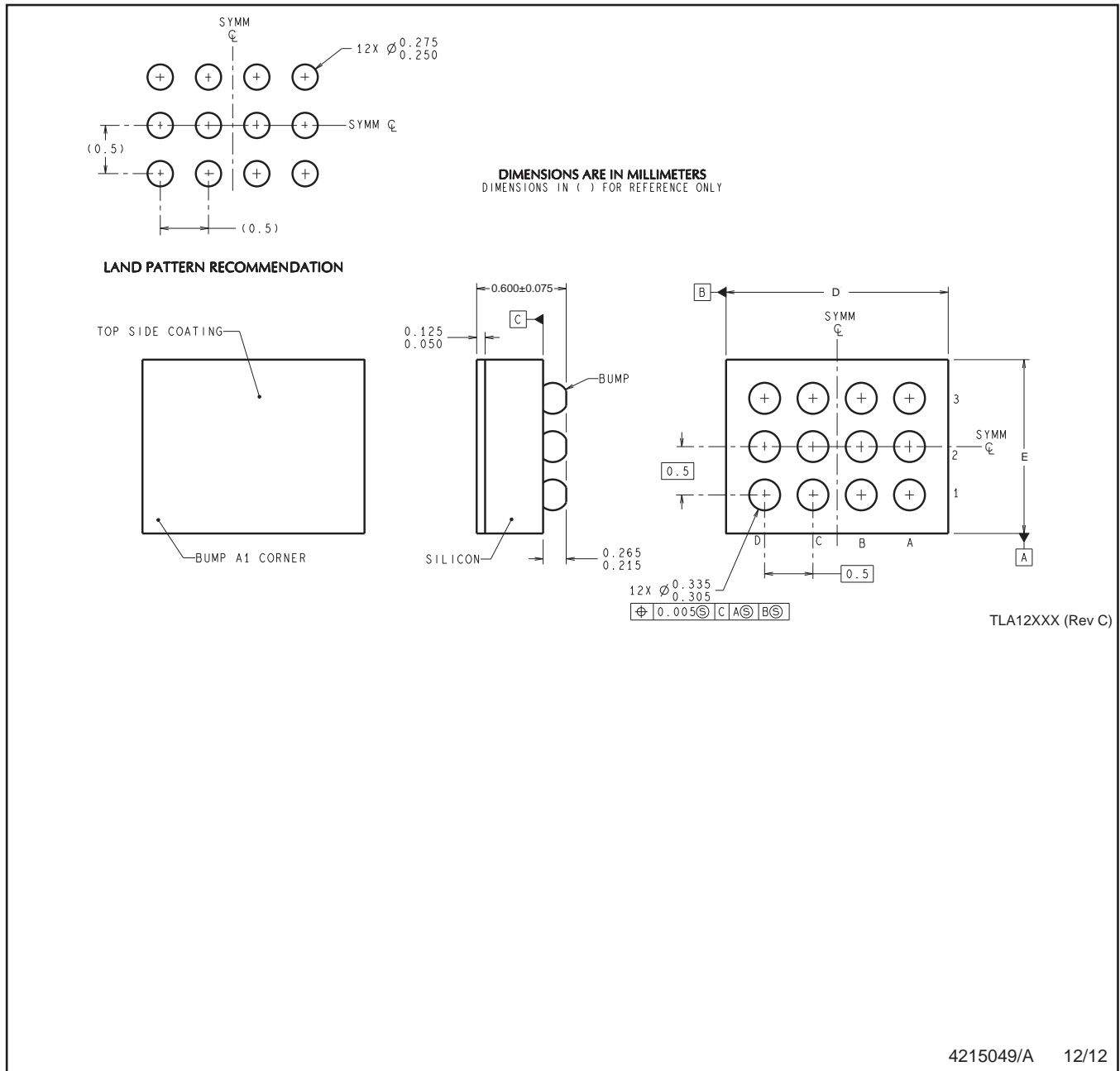

4215049/A 12/12

NOTES: A. All linear dimensions are in millimeters. Dimensioning and tolerancing per ASME Y14.5M-1994.  
 B. This drawing is subject to change without notice.



## IMPORTANT NOTICE

Texas Instruments Incorporated and its subsidiaries (TI) reserve the right to make corrections, enhancements, improvements and other changes to its semiconductor products and services per JESD46, latest issue, and to discontinue any product or service per JESD48, latest issue. Buyers should obtain the latest relevant information before placing orders and should verify that such information is current and complete. All semiconductor products (also referred to herein as "components") are sold subject to TI's terms and conditions of sale supplied at the time of order acknowledgment.

TI warrants performance of its components to the specifications applicable at the time of sale, in accordance with the warranty in TI's terms and conditions of sale of semiconductor products. Testing and other quality control techniques are used to the extent TI deems necessary to support this warranty. Except where mandated by applicable law, testing of all parameters of each component is not necessarily performed.

TI assumes no liability for applications assistance or the design of Buyers' products. Buyers are responsible for their products and applications using TI components. To minimize the risks associated with Buyers' products and applications, Buyers should provide adequate design and operating safeguards.

TI does not warrant or represent that any license, either express or implied, is granted under any patent right, copyright, mask work right, or other intellectual property right relating to any combination, machine, or process in which TI components or services are used. Information published by TI regarding third-party products or services does not constitute a license to use such products or services or a warranty or endorsement thereof. Use of such information may require a license from a third party under the patents or other intellectual property of the third party, or a license from TI under the patents or other intellectual property of TI.

Reproduction of significant portions of TI information in TI data books or data sheets is permissible only if reproduction is without alteration and is accompanied by all associated warranties, conditions, limitations, and notices. TI is not responsible or liable for such altered documentation. Information of third parties may be subject to additional restrictions.

Resale of TI components or services with statements different from or beyond the parameters stated by TI for that component or service voids all express and any implied warranties for the associated TI component or service and is an unfair and deceptive business practice. TI is not responsible or liable for any such statements.

Buyer acknowledges and agrees that it is solely responsible for compliance with all legal, regulatory and safety-related requirements concerning its products, and any use of TI components in its applications, notwithstanding any applications-related information or support that may be provided by TI. Buyer represents and agrees that it has all the necessary expertise to create and implement safeguards which anticipate dangerous consequences of failures, monitor failures and their consequences, lessen the likelihood of failures that might cause harm and take appropriate remedial actions. Buyer will fully indemnify TI and its representatives against any damages arising out of the use of any TI components in safety-critical applications.

In some cases, TI components may be promoted specifically to facilitate safety-related applications. With such components, TI's goal is to help enable customers to design and create their own end-product solutions that meet applicable functional safety standards and requirements. Nonetheless, such components are subject to these terms.

No TI components are authorized for use in FDA Class III (or similar life-critical medical equipment) unless authorized officers of the parties have executed a special agreement specifically governing such use.

Only those TI components which TI has specifically designated as military grade or "enhanced plastic" are designed and intended for use in military/aerospace applications or environments. Buyer acknowledges and agrees that any military or aerospace use of TI components which have **not** been so designated is solely at the Buyer's risk, and that Buyer is solely responsible for compliance with all legal and regulatory requirements in connection with such use.

TI has specifically designated certain components as meeting ISO/TS16949 requirements, mainly for automotive use. In any case of use of non-designated products, TI will not be responsible for any failure to meet ISO/TS16949.

### Products

|                              |  |
|------------------------------|--|
| Audio                        | <a href="http://www.ti.com/audio">www.ti.com/audio</a>                               |
| Amplifiers                   | <a href="http://amplifier.ti.com">amplifier.ti.com</a>                               |
| Data Converters              | <a href="http://dataconverter.ti.com">dataconverter.ti.com</a>                       |
| DLP® Products                | <a href="http://www.dlp.com">www.dlp.com</a>   |
| DSP                          | <a href="http://dsp.ti.com">dsp.ti.com</a>   |
| Clocks and Timers            | <a href="http://www.ti.com/clocks">www.ti.com/clocks</a>                             |
| Interface                    | <a href="http://interface.ti.com">interface.ti.com</a>                               |
| Logic                        | <a href="http://logic.ti.com">logic.ti.com</a>                                       |
| Power Mgmt                   | <a href="http://power.ti.com">power.ti.com</a>                                       |
| Microcontrollers             | <a href="http://microcontroller.ti.com">microcontroller.ti.com</a>                   |
| RFID                         | <a href="http://www.ti-rfid.com">www.ti-rfid.com</a>                                 |
| OMAP Applications Processors | <a href="http://www.ti.com/omap">www.ti.com/omap</a>                                 |
| Wireless Connectivity        | <a href="http://www.ti.com/wirelessconnectivity">www.ti.com/wirelessconnectivity</a> |

### Applications

|                               |  |
|-------------------------------|--|
| Automotive and Transportation | <a href="http://www.ti.com/automotive">www.ti.com/automotive</a>                         |
| Communications and Telecom    | <a href="http://www.ti.com/communications">www.ti.com/communications</a>                 |
| Computers and Peripherals     | <a href="http://www.ti.com/computers">www.ti.com/computers</a>                           |
| Consumer Electronics          | <a href="http://www.ti.com/consumer-apps">www.ti.com/consumer-apps</a>                   |
| Energy and Lighting           | <a href="http://www.ti.com/energy">www.ti.com/energy</a>                                 |
| Industrial                    | <a href="http://www.ti.com/industrial">www.ti.com/industrial</a>                         |
| Medical                       | <a href="http://www.ti.com/medical">www.ti.com/medical</a>                               |
| Security                      | <a href="http://www.ti.com/security">www.ti.com/security</a>                             |
| Space, Avionics and Defense   | <a href="http://www.ti.com/space-avionics-defense">www.ti.com/space-avionics-defense</a> |
| Video and Imaging             | <a href="http://www.ti.com/video">www.ti.com/video</a>                                   |

### TI E2E Community

[e2e.ti.com](http://e2e.ti.com)