

LM3046 Transistor Array

Check for Samples: [LM3046](#)

FEATURES

- Two Matched Pairs of Transistors
 - V_{BE} Matched ± 5 mV
 - Input Offset Current 2 μ A Max at $I_C = 1$ mA
- Five General Purpose Monolithic transistors
- Operation from DC to 120 MHz
- Wide Operating Current Range
- Low Noise Figure: 3.2 dB typ at 1 kHz

APPLICATIONS

- General Use in All Types of Signal Processing Systems Operating Anywhere in the Frequency Range from DC to VHF
- Custom Designed Differential Amplifiers
- Temperature Compensated Amplifiers

DESCRIPTION

The LM3046 consists of five general purpose silicon NPN transistors on a common monolithic substrate. Two of the transistors are internally connected to form a differentially-connected pair. The transistors are well suited to a wide variety of applications in low power system in the DC through VHF range. They may be used as discrete transistors in conventional circuits however, in addition, they provide the very significant inherent integrated circuit advantages of close electrical and thermal matching. The LM3046 is supplied in a 14-lead SOIC package.

Schematic and Connection Diagram

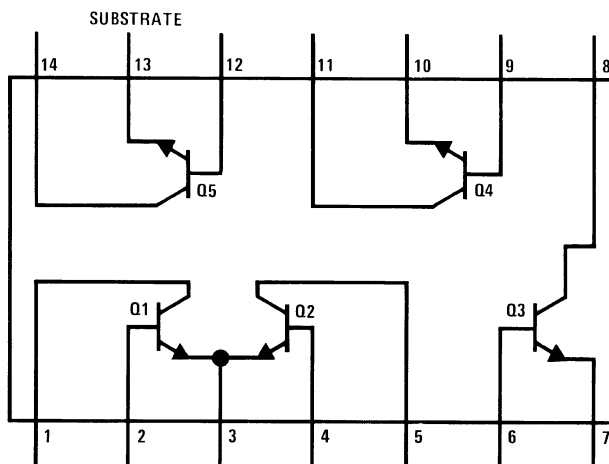

**Figure 1. SOIC Package
Top View
See Package Number D (R-PDSO-G14)**



These devices have limited built-in ESD protection. The leads should be shorted together or the device placed in conductive foam during storage or handling to prevent electrostatic damage to the MOS gates.



Please be aware that an important notice concerning availability, standard warranty, and use in critical applications of Texas Instruments semiconductor products and disclaimers thereto appears at the end of this data sheet.

All trademarks are the property of their respective owners.

Absolute Maximum Ratings⁽¹⁾⁽²⁾⁽³⁾

		Each Transistor	Total Package	Units
Power Dissipation	$T_A = 25^\circ\text{C}$	300	750	mW
	$T_A = 25^\circ\text{C}$ to 55°C	300	750	
	$T_A > 55^\circ\text{C}$	Derate at 6.67		mW/ $^\circ\text{C}$
	$T_A = 25^\circ\text{C}$ to 75°C			mW
	$T_A > 75^\circ\text{C}$			mW/ $^\circ\text{C}$
Collector to Emitter Voltage, V_{CEO}		15		V
Collector to Base Voltage, V_{CBO}		20		
Collector to Substrate Voltage, V_{CISO} ⁽⁴⁾		20		
Emitter to Base Voltage, V_{EBO}		5		
Collector Current, I_C		50		mA
Operating Temperature Range		-40 $^\circ\text{C}$ to +85 $^\circ\text{C}$		
Storage Temperature Range		-65 $^\circ\text{C}$ to +85 $^\circ\text{C}$		
Soldering Information	Dual-In-Line Package Soldering (10 Sec.)	260 $^\circ\text{C}$		
	SOIC Package			
	Vapor Phase (60 Seconds)	215 $^\circ\text{C}$		
	Infrared (15 Seconds)	220 $^\circ\text{C}$		

- (1) "Absolute Maximum Ratings" indicate limits beyond which damage to the device may occur. Operating Ratings indicate conditions for which the device is functional, but do not guarantee specific performance limits.
- (2) See AN-450 "Surface Mounting Methods and Their Effect on Product Reliability" for other methods of soldering surface mount devices.
- (3) If Military/Aerospace specified devices are required, please contact the Texas Instruments Sales Office/ Distributors for availability and specifications.
- (4) The collector of each transistor is isolated from the substrate by an integral diode. The substrate (terminal 13) must be connected to the most negative point in the external circuit to maintain isolation between transistors and to provide for normal transistor action.

Electrical Characteristics⁽¹⁾

Parameter	Conditions	Min	Typ	Max	Units
Collector to Base Breakdown Voltage ($V_{(BR)CBO}$)	$I_C = 10 \mu A, I_E = 0$	20	60		V
Collector to Emitter Breakdown Voltage ($V_{(BR)CEO}$)	$I_C = 1 mA, I_B = 0$	15	24		V
Collector to Substrate Breakdown Voltage ($V_{(BR)CIO}$)	$I_C = 10 \mu A, I_{CI} = 0$	20	60		V
Emitter to Base Breakdown Voltage ($V_{(BR)EBO}$)	$I_E = 10 \mu A, I_C = 0$	5	7		V
Collector Cutoff Current (I_{CBO})	$V_{CB} = 10V, I_E = 0$		0.002	40	nA
Collector Cutoff Current (I_{CEO})	$V_{CE} = 10V, I_B = 0$			0.5	μA
Static Forward Current Transfer Ratio (Static Beta) (h_{FE})	$V_{CE} = 3V, I_C = 10 mA$		100		
	$I_C = 1 mA$	40	100		
	$I_C = 10 \mu A$		54		
Input Offset Current for Matched Pair Q_1 and Q_2 $ I_{O1} - I_{O2} $	$V_{CE} = 3V, I_C = 1 mA$		0.3	2	μA
Base to Emitter Voltage (V_{BE})	$V_{CE} = 3V, I_E = 1 mA$		0.715		V
	$I_E = 10 mA$		0.800		
Magnitude of Input Offset Voltage for Differential Pair $ V_{BE1} - V_{BE2} $	$V_{CE} = 3V, I_C = 1 mA$		0.45	5	mV
Magnitude of Input Offset Voltage for Isolated Transistors $ V_{BE3} - V_{BE4} , V_{BE4} - V_{BE5} , V_{BE5} - V_{BE3} $	$V_{CE} = 3V, I_C = 1 mA$		0.45	5	mV
Temperature Coefficient of Base to Emitter Voltage $\left(\frac{\Delta V_{BE}}{\Delta T}\right)$ (1)	$V_{CE} = 3V, I_C = 1 mA$		-1.9		$mV/^{\circ}C$
Collector to Emitter Saturation Voltage ($V_{CE(SAT)}$)	$I_B = 1 mA, I_C = 10 mA$		0.23		V
Temperature Coefficient of Input Offset Voltage $\left(\frac{\Delta V_{10}}{\Delta T}\right)$ (2)	$V_{CE} = 3V, I_C = 1 mA$		1.1		$\mu V/^{\circ}C$
Low Frequency Noise Figure (NF)	$f = 1 kHz, V_{CE} = 3V, I_C = 100 \mu A, R_S = 1 k\Omega$		3.25		dB
LOW FREQUENCY, SMALL SIGNAL EQUIVALENT CIRCUIT CHARACTERISTICS					
Forward Current Transfer Ratio (h_{fe})	$f = 1 kHz, V_{CE} = 3V, I_C = 1 mA$		110		
Short Circuit Input Impedance (h_{ie})			3.5		$k\Omega$
Open Circuit Output Impedance (h_{oe})			15.6		μmho
Open Circuit Reverse Voltage Transfer Ratio (h_{re})			1.8×10^{-4}		
ADMITTANCE CHARACTERISTICS					
Forward Transfer Admittance (Y_{fe})	$f = 1 MHz, V_{CE} = 3V, I_C = 1 mA$		$31 - j 1.5$		
Input Admittance (Y_{ie})			$0.3 + j 0.04$		
Output Admittance (Y_{oe})			$0.001 + j 0.03$		
Reverse Transfer Admittance (Y_{re})			See Figure 16		
Gain Bandwidth Product (f_T)	$V_{CE} = 3V, I_C = 3 mA$	300	550		
Emitter to Base Capacitance (C_{EB})	$V_{EB} = 3V, I_E = 0$		0.6		pF
Collector to Base Capacitance (C_{CB})	$V_{CB} = 3V, I_C = 0$		0.58		pF
Collector to Substrate Capacitance (C_{CI})	$V_{CS} = 3V, I_C = 0$		2.8		pF

(1) ($T_A = 25^{\circ}C$ unless otherwise specified)

Typical Performance Characteristics

Typical Collector To Base Cutoff Current vs Ambient Temperature for Each Transistor

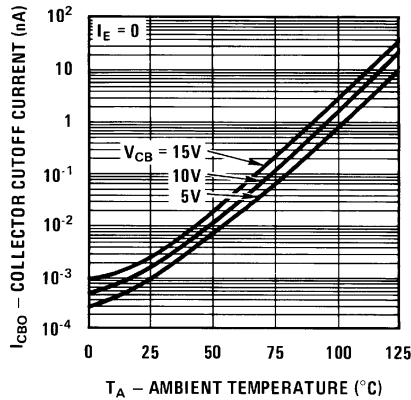

Figure 2.

Typical Collector To Emitter Cutoff Current vs Ambient Temperature for Each Transistor

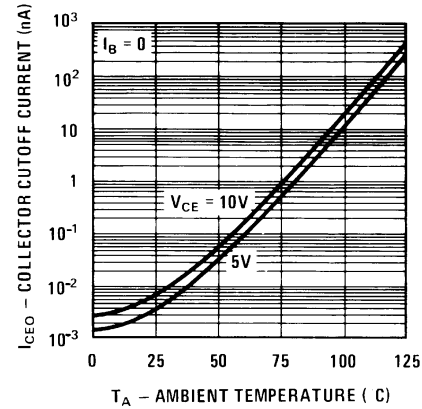

Figure 3.

Typical Static Forward Current-Transfer Ratio and Beta Ratio for Transistors Q₁ and Q₂ vs Emitter Current

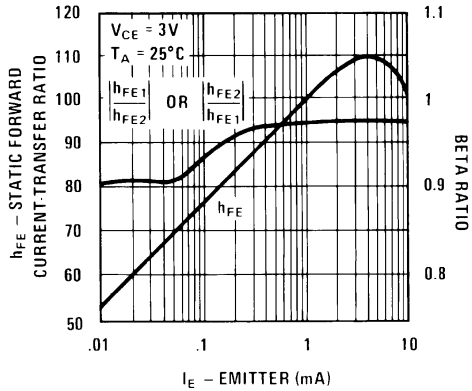

Figure 4.

Typical Input Offset Current for Matched Transistor Pair Q₁ Q₂ vs Collector Current

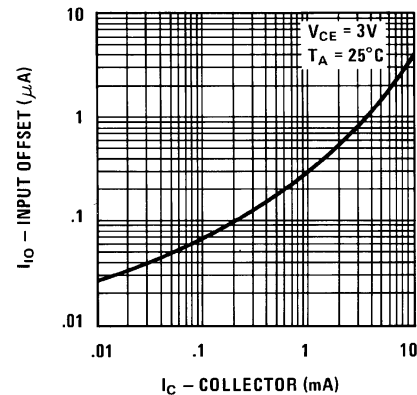

Figure 5.

Typical Static Base To Emitter Voltage Characteristic and Input Offset Voltage for Differential Pair and Paired Isolated Transistors vs Emitter Current

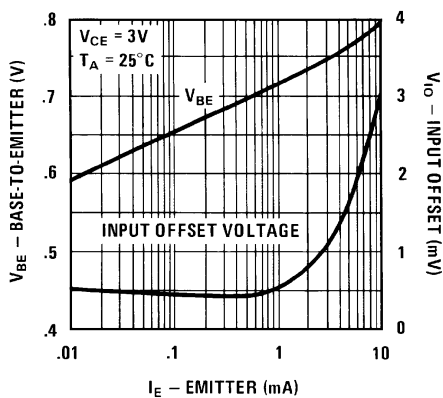

Figure 6.

Typical Base To Emitter Voltage Characteristic for Each Transistor vs Ambient Temperature

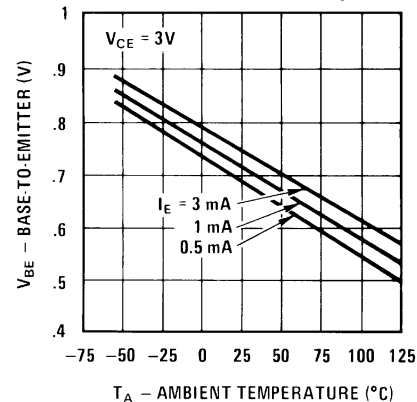

Figure 7.

Typical Performance Characteristics (continued)

Typical Input Offset Voltage Characteristics for Differential Pair and Paired Isolated Transistors vs Ambient Temperature

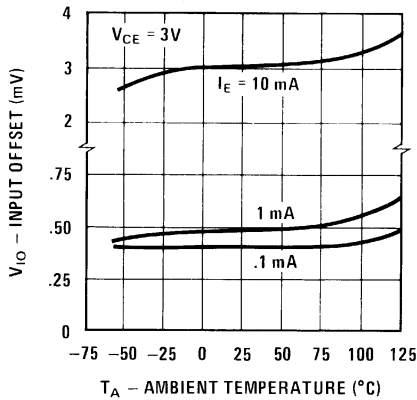

Figure 8.

Typical Noise Figure vs Collector Current

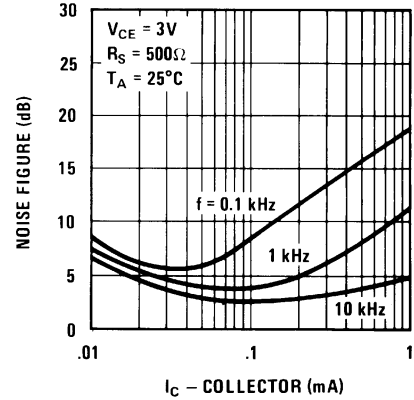

Figure 9.

Typical Noise Figure vs Collector Current

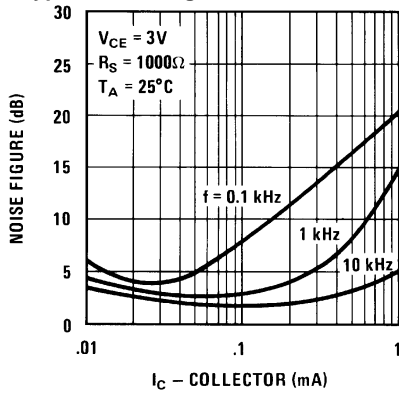

Figure 10.

Typical Noise Figure vs Collector Current

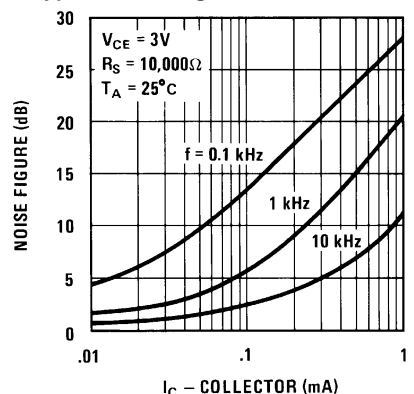

Figure 11.

Typical Normalized Forward Current Transfer Ratio, Short Circuit Input Impedance, Open Circuit Output Impedance, and Open Circuit Reverse Transfer Ratio vs Collector Current

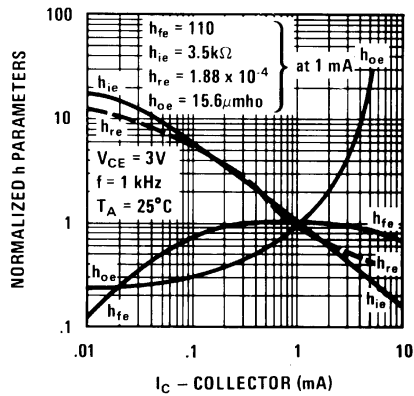

Figure 12.

Typical Forward Transfer Admittance vs Frequency

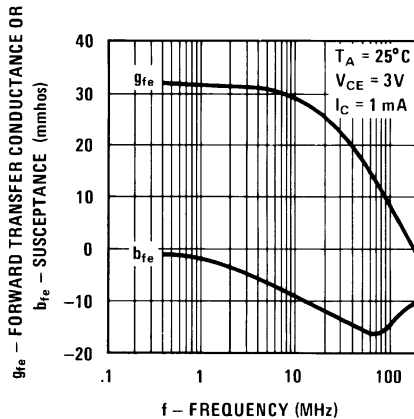

Figure 13.

Typical Performance Characteristics (continued)

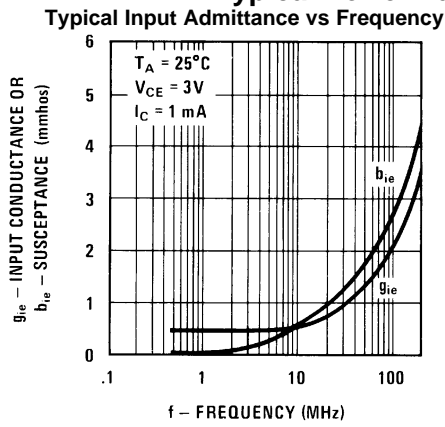

Figure 14.

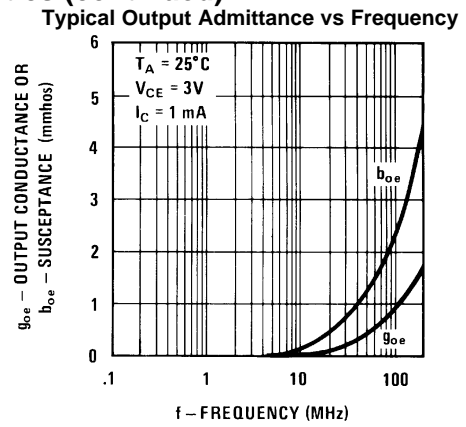

Figure 15.

Typical Reverse Transfer Admittance vs Frequency

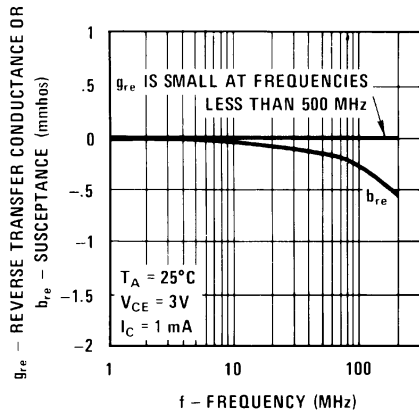

Figure 16.

Typical Gain-Bandwidth Product vs Collector Current

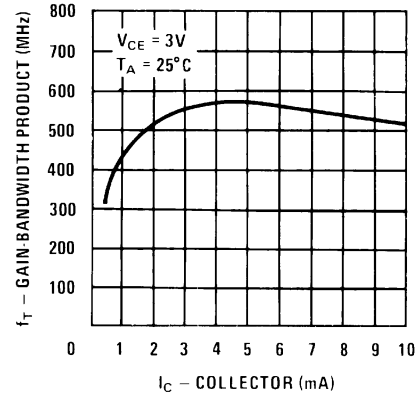

Figure 17.

REVISION HISTORY

Changes from Revision A (March 2013) to Revision B	Page
• Changed layout of National Data Sheet to TI format	4

PACKAGING INFORMATION

Orderable Device	Status (1)	Package Type	Package Drawing	Pins	Package Qty	Eco Plan (2)	Lead/Ball Finish (6)	MSL Peak Temp (3)	Op Temp (°C)	Device Marking (4/5)	Samples
LM3046M	LIFEBUY	SOIC	D	14	55	TBD	Call TI	Call TI	-40 to 85	LM3046M	
LM3046M/NOPB	LIFEBUY	SOIC	D	14	55	Green (RoHS & no Sb/Br)	CU SN	Level-1-260C-UNLIM	-40 to 85	LM3046M	
LM3046MX/NOPB	LIFEBUY	SOIC	D	14	2500	Green (RoHS & no Sb/Br)	CU SN	Level-1-260C-UNLIM	-40 to 85	LM3046M	

(1) The marketing status values are defined as follows:

ACTIVE: Product device recommended for new designs.

LIFEBUY: TI has announced that the device will be discontinued, and a lifetime-buy period is in effect.

NRND: Not recommended for new designs. Device is in production to support existing customers, but TI does not recommend using this part in a new design.

PREVIEW: Device has been announced but is not in production. Samples may or may not be available.

OBSOLETE: TI has discontinued the production of the device.

(2) **RoHS:** TI defines "RoHS" to mean semiconductor products that are compliant with the current EU RoHS requirements for all 10 RoHS substances, including the requirement that RoHS substance do not exceed 0.1% by weight in homogeneous materials. Where designed to be soldered at high temperatures, "RoHS" products are suitable for use in specified lead-free processes. TI may reference these types of products as "Pb-Free".

RoHS Exempt: TI defines "RoHS Exempt" to mean products that contain lead but are compliant with EU RoHS pursuant to a specific EU RoHS exemption.

Green: TI defines "Green" to mean the content of Chlorine (Cl) and Bromine (Br) based flame retardants meet JS709B low halogen requirements of <=1000ppm threshold. Antimony trioxide based flame retardants must also meet the <=1000ppm threshold requirement.

(3) MSL, Peak Temp. - The Moisture Sensitivity Level rating according to the JEDEC industry standard classifications, and peak solder temperature.

(4) There may be additional marking, which relates to the logo, the lot trace code information, or the environmental category on the device.

(5) Multiple Device Markings will be inside parentheses. Only one Device Marking contained in parentheses and separated by a "~" will appear on a device. If a line is indented then it is a continuation of the previous line and the two combined represent the entire Device Marking for that device.

(6) Lead/Ball Finish - Orderable Devices may have multiple material finish options. Finish options are separated by a vertical ruled line. Lead/Ball Finish values may wrap to two lines if the finish value exceeds the maximum column width.

Important Information and Disclaimer:The information provided on this page represents TI's knowledge and belief as of the date that it is provided. TI bases its knowledge and belief on information provided by third parties, and makes no representation or warranty as to the accuracy of such information. Efforts are underway to better integrate information from third parties. TI has taken and continues to take reasonable steps to provide representative and accurate information but may not have conducted destructive testing or chemical analysis on incoming materials and chemicals. TI and TI suppliers consider certain information to be proprietary, and thus CAS numbers and other limited information may not be available for release.

In no event shall TI's liability arising out of such information exceed the total purchase price of the TI part(s) at issue in this document sold by TI to Customer on an annual basis.

TAPE AND REEL INFORMATION



QUADRANT ASSIGNMENTS FOR PIN 1 ORIENTATION IN TAPE



*All dimensions are nominal

Device	Package Type	Package Drawing	Pins	SPQ	Reel Diameter (mm)	Reel Width W1 (mm)	A0 (mm)	B0 (mm)	K0 (mm)	P1 (mm)	W (mm)	Pin1 Quadrant
LM3046MX/NOPB	SOIC	D	14	2500	330.0	16.4	6.5	9.35	2.3	8.0	16.0	Q1

TAPE AND REEL BOX DIMENSIONS



*All dimensions are nominal

Device	Package Type	Package Drawing	Pins	SPQ	Length (mm)	Width (mm)	Height (mm)
LM3046MX/NOPB	SOIC	D	14	2500	367.0	367.0	35.0

D (R-PDSO-G14)

PLASTIC SMALL OUTLINE

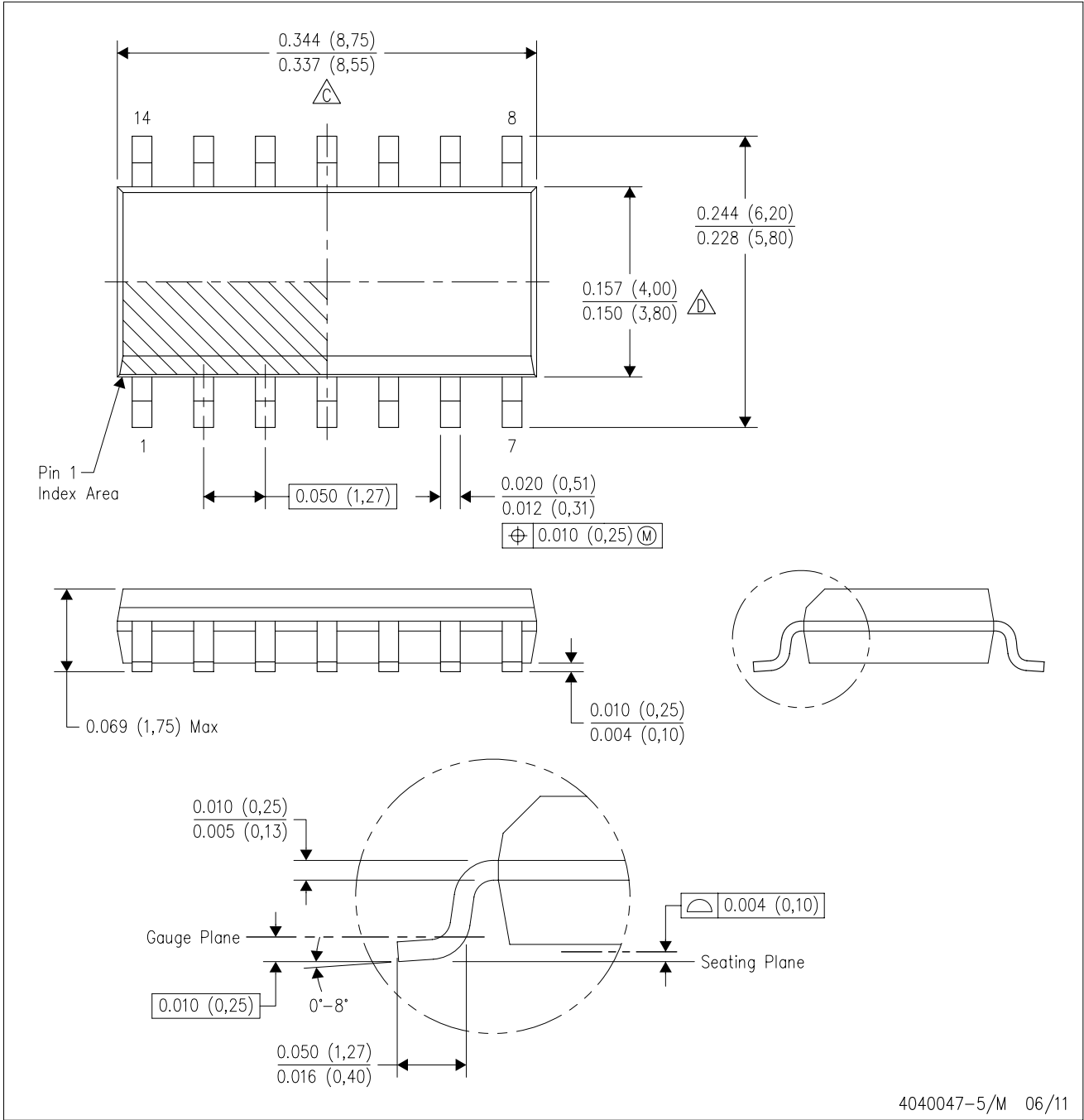

- NOTES:
- A. All linear dimensions are in inches (millimeters).
 - B. This drawing is subject to change without notice.
 - $\triangle C$ Body length does not include mold flash, protrusions, or gate burrs. Mold flash, protrusions, or gate burrs shall not exceed 0.006 (0,15) each side.
 - $\triangle D$ Body width does not include interlead flash. Interlead flash shall not exceed 0.017 (0,43) each side.
 - E. Reference JEDEC MS-012 variation AB.

IMPORTANT NOTICE

Texas Instruments Incorporated (TI) reserves the right to make corrections, enhancements, improvements and other changes to its semiconductor products and services per JESD46, latest issue, and to discontinue any product or service per JESD48, latest issue. Buyers should obtain the latest relevant information before placing orders and should verify that such information is current and complete.

TI's published terms of sale for semiconductor products (<http://www.ti.com/sc/docs/stdterms.htm>) apply to the sale of packaged integrated circuit products that TI has qualified and released to market. Additional terms may apply to the use or sale of other types of TI products and services.

Reproduction of significant portions of TI information in TI data sheets is permissible only if reproduction is without alteration and is accompanied by all associated warranties, conditions, limitations, and notices. TI is not responsible or liable for such reproduced documentation. Information of third parties may be subject to additional restrictions. Resale of TI products or services with statements different from or beyond the parameters stated by TI for that product or service voids all express and any implied warranties for the associated TI product or service and is an unfair and deceptive business practice. TI is not responsible or liable for any such statements.

Buyers and others who are developing systems that incorporate TI products (collectively, "Designers") understand and agree that Designers remain responsible for using their independent analysis, evaluation and judgment in designing their applications and that Designers have full and exclusive responsibility to assure the safety of Designers' applications and compliance of their applications (and of all TI products used in or for Designers' applications) with all applicable regulations, laws and other applicable requirements. Designer represents that, with respect to their applications, Designer has all the necessary expertise to create and implement safeguards that (1) anticipate dangerous consequences of failures, (2) monitor failures and their consequences, and (3) lessen the likelihood of failures that might cause harm and take appropriate actions. Designer agrees that prior to using or distributing any applications that include TI products, Designer will thoroughly test such applications and the functionality of such TI products as used in such applications.

TI's provision of technical, application or other design advice, quality characterization, reliability data or other services or information, including, but not limited to, reference designs and materials relating to evaluation modules, (collectively, "TI Resources") are intended to assist designers who are developing applications that incorporate TI products; by downloading, accessing or using TI Resources in any way, Designer (individually or, if Designer is acting on behalf of a company, Designer's company) agrees to use any particular TI Resource solely for this purpose and subject to the terms of this Notice.

TI's provision of TI Resources does not expand or otherwise alter TI's applicable published warranties or warranty disclaimers for TI products, and no additional obligations or liabilities arise from TI providing such TI Resources. TI reserves the right to make corrections, enhancements, improvements and other changes to its TI Resources. TI has not conducted any testing other than that specifically described in the published documentation for a particular TI Resource.

Designer is authorized to use, copy and modify any individual TI Resource only in connection with the development of applications that include the TI product(s) identified in such TI Resource. NO OTHER LICENSE, EXPRESS OR IMPLIED, BY ESTOPPEL OR OTHERWISE TO ANY OTHER TI INTELLECTUAL PROPERTY RIGHT, AND NO LICENSE TO ANY TECHNOLOGY OR INTELLECTUAL PROPERTY RIGHT OF TI OR ANY THIRD PARTY IS GRANTED HEREIN, including but not limited to any patent right, copyright, mask work right, or other intellectual property right relating to any combination, machine, or process in which TI products or services are used. Information regarding or referencing third-party products or services does not constitute a license to use such products or services, or a warranty or endorsement thereof. Use of TI Resources may require a license from a third party under the patents or other intellectual property of the third party, or a license from TI under the patents or other intellectual property of TI.

TI RESOURCES ARE PROVIDED "AS IS" AND WITH ALL FAULTS. TI DISCLAIMS ALL OTHER WARRANTIES OR REPRESENTATIONS, EXPRESS OR IMPLIED, REGARDING RESOURCES OR USE THEREOF, INCLUDING BUT NOT LIMITED TO ACCURACY OR COMPLETENESS, TITLE, ANY EPIDEMIC FAILURE WARRANTY AND ANY IMPLIED WARRANTIES OF MERCHANTABILITY, FITNESS FOR A PARTICULAR PURPOSE, AND NON-INFRINGEMENT OF ANY THIRD PARTY INTELLECTUAL PROPERTY RIGHTS. TI SHALL NOT BE LIABLE FOR AND SHALL NOT DEFEND OR INDEMNIFY DESIGNER AGAINST ANY CLAIM, INCLUDING BUT NOT LIMITED TO ANY INFRINGEMENT CLAIM THAT RELATES TO OR IS BASED ON ANY COMBINATION OF PRODUCTS EVEN IF DESCRIBED IN TI RESOURCES OR OTHERWISE. IN NO EVENT SHALL TI BE LIABLE FOR ANY ACTUAL, DIRECT, SPECIAL, COLLATERAL, INDIRECT, PUNITIVE, INCIDENTAL, CONSEQUENTIAL OR EXEMPLARY DAMAGES IN CONNECTION WITH OR ARISING OUT OF TI RESOURCES OR USE THEREOF, AND REGARDLESS OF WHETHER TI HAS BEEN ADVISED OF THE POSSIBILITY OF SUCH DAMAGES.

Unless TI has explicitly designated an individual product as meeting the requirements of a particular industry standard (e.g., ISO/TS 16949 and ISO 26262), TI is not responsible for any failure to meet such industry standard requirements.

Where TI specifically promotes products as facilitating functional safety or as compliant with industry functional safety standards, such products are intended to help enable customers to design and create their own applications that meet applicable functional safety standards and requirements. Using products in an application does not by itself establish any safety features in the application. Designers must ensure compliance with safety-related requirements and standards applicable to their applications. Designer may not use any TI products in life-critical medical equipment unless authorized officers of the parties have executed a special contract specifically governing such use. Life-critical medical equipment is medical equipment where failure of such equipment would cause serious bodily injury or death (e.g., life support, pacemakers, defibrillators, heart pumps, neurostimulators, and implantables). Such equipment includes, without limitation, all medical devices identified by the U.S. Food and Drug Administration as Class III devices and equivalent classifications outside the U.S.

TI may expressly designate certain products as completing a particular qualification (e.g., Q100, Military Grade, or Enhanced Product). Designers agree that it has the necessary expertise to select the product with the appropriate qualification designation for their applications and that proper product selection is at Designers' own risk. Designers are solely responsible for compliance with all legal and regulatory requirements in connection with such selection.

Designer will fully indemnify TI and its representatives against any damages, costs, losses, and/or liabilities arising out of Designer's non-compliance with the terms and provisions of this Notice.