

ADS42LBx9EVM

The ADS42LB49 and ADS42LB69 are dual-channel, 250-MSPS, analog-to-digital converters that are 14-bit and 16-bit resolutions, respectively. The ADS42LB49EVM and ADS42LB69EVM (ADS42LBx9EVM) are specifically suited for interfacing with TI's TSW1400EVM to capture and display waveforms from the ADC. The EVM schematic, BOM, and layout files are found in the design package in the ADS42LBx9EVM product folder on www.ti.com.

Contents

1	Introduction	2
1.1	Overview	2
1.2	Block Diagram	2
2	Software Control	3
2.1	Installation Instructions	3
2.2	Software Operation	4
3	Basic Test Setup	8
3.1	Test Block Diagram	8
3.2	TSW1400EVM Setup	8
3.3	ADS42LBx9EVM Quick-Start Procedure	9

List of Figures

1	Block Diagram of the ADS42LBx9EVM	2
2	Top-Level Block Diagram Window of the ADS42LBx9 GUI	4
3	ADC Controls Window of the ADS42LBx9 GUI	5
4	Digital Block Controls Window of the ADS42LBx9 GUI	6
5	LVDS Controls Window of the ADS42LBx9 GUI	7
6	Quick Start Test Setup for the ADS42LBx9EVM	8
7	ADS42LB69 Sample Capture using the TSW1400	10

List of Tables

1	Input and Output Connectors and Jumper Descriptions of the ADS42LBx9EVM	3
2	ADC Controls Window Descriptions	5
3	Digital Block Controls Window Descriptions	6
4	LVDS Controls Window Descriptions	7

1 Introduction

1.1 Overview

The ADS42LB49EVM and ADS42LB69EVM (ADS42LBx9EVM) are evaluation modules (EVMs) that allow for the evaluation of TI's ADS42LB49 and ADS42LB69. The ADS42LB49 and ADS42LB69 (ADS42LBx9) are dual-channel, low-power, 250-MSPS analog-to-digital converters (ADC) with 14-bit and 16-bit resolutions, respectively and buffered analog inputs and LVDS outputs. The EVM has transformer coupled analog and clock inputs to accommodate a wide range of signal sources and frequencies. The ADS42LBx9 is programmable through an easy-to-use software GUI enabling quick configuration for a variety of uses.

The ADS42LBx9EVM is designed to mate with the TSW1400EVM which is a full-function data-capture card. The High Speed Data Converter Pro (HSDCPro) software GUI can then process the data from the TSW1400EVM to quickly assess the performance of the ADS42LBx9. It is also compatible with Altera and Xilinx FPGA development platforms which have FMC or HSMC connectors, via the appropriate interposer card.

1.2 Block Diagram

The block diagram for the ADS42LBx9EVM is shown in [Figure 1](#). The various inputs, outputs, and jumpers of the ADS42LBx9EVM are described in [Table 1](#).

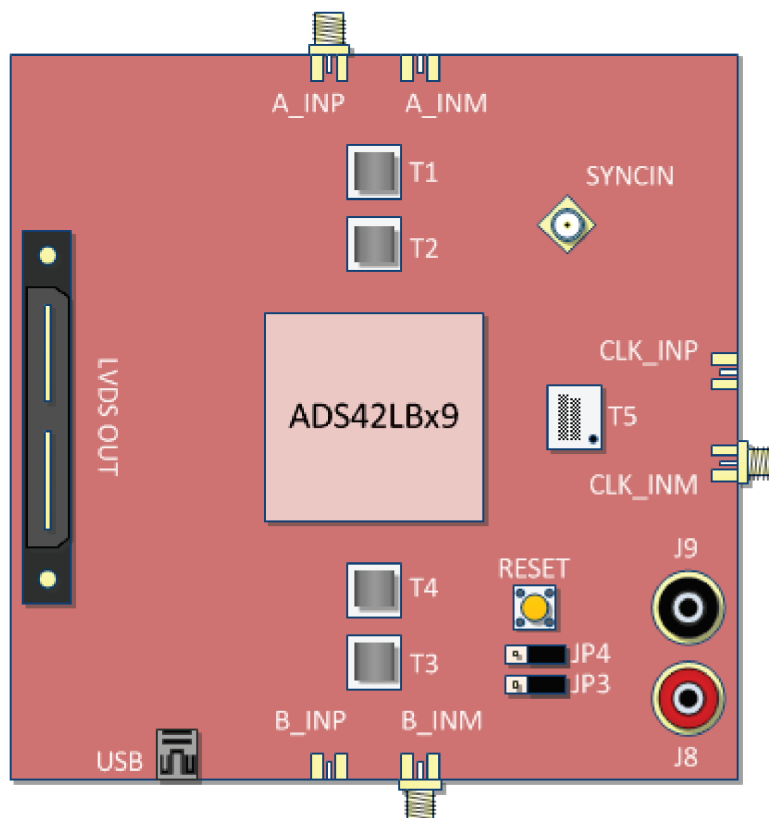

Figure 1. Block Diagram of the ADS42LBx9EVM

Table 1. Input and Output Connectors and Jumper Descriptions of the ADS42LBx9EVM

Component	Description
A_INP	Single-ended analog input for channel A
B_INM	Single-ended analog input for channel B
CLK_INM	Single-ended ADC clock input
J8	Positive power connection (3.3 V)
J9	Negative power connection (GND)
USB	USB connection
LVDS OUT	LVDS connector to connect to the TSW1400
SYNCIN	ADC sync input
RESET	Switch to reset the ADC using the RESET pin
JP4	ADC CNTRL1 pin, controls power down modes (default: short 2-3)
JP3	ADC CNTRL2 pin, controls power down modes (default: short 2-3)

2 Software Control

This section provides installation instructions for the ADS42LBx9 GUI and descriptions of the various controls.

2.1 Installation Instructions

1. The software can be downloaded from the ADS42LB69EVM product page on www.ti.com. Find the page by searching for *ADS42LB69EVM*.
2. Extract the files from the zip file named *ADS42LBx9 GUI vXpY installer.zip* where XpY represents the version number.
3. Run *setup.exe* and follow the installation prompts.
4. Start the GUI by going to **Start Menu** → **All Programs** → **Texas Instruments ADCs** → **ADS42LBx9 GUI**.
5. When plugging the board into the computer for the first time through the USB cable, you are prompted to install the USB drivers.
 - Windows® XP: If Windows XP does not automatically install the drivers, follow the prompts on the screen to do so. Do not let Windows XP search Microsoft Update for the drivers, but do let Windows XP install the drivers automatically.
 - Windows 7: After installing the GUI, Windows 7 should automatically be able to install the drivers for the ADS42LBx9EVM with no input from the user.

2.2 Software Operation

The software GUI allows full programming control of the ADS42LBx9 device. [Figure 2](#) shows the GUI front panel which contains a block diagram of the ADS42LBx9. Clicking on the various blocks of the ADS42LBx9 allows configuration of the settings for that block. Detailed descriptions for each screen of the GUI are given in this section. Please refer to the ADS42LBx9 datasheet ([SLAS904](#)) for more detailed explanations of the register fields.

2.2.1 Top Level

[Figure 2](#) shows the top-level view of the GUI which contains the block diagram of the ADS42LBx9. The blue blocks can be clicked on to see the controls for that block. Along the top of the GUI are **SEND**, **READ**, **SAVE**, and **LOAD** buttons. The **SEND** and **READ** buttons write or read all of the registers of the ADS42LBx9. The **SAVE** and **LOAD** buttons can be used to save or load a text file of the registers. The flashing **RESET** button can be clicked to reset the USB port connection. It reads **CONNECTED** when the GUI is successfully connected to the EVM. On the right side is a white text box that shows the registers as they are written to the device, it also shows the results of a read command.

The ADS42LBx9 reset and powerdown controls are available in the top-left corner, for easy access. The reset control automatically clears in the device, so only a single mouse click is needed. The **DEVICE ON** button displays **DEVICE OFF** when clicked and the device has been powered down. Monitoring the power supply current when toggling the power down mode is a simple way to verify that the GUI is communicating with the device. Finally, the *Divide by 1,2,4* block is a control that sets the internal clock divider. The clock divider value is shown above the block. Note that clicking on this block does not take the user away from the top-level screen.

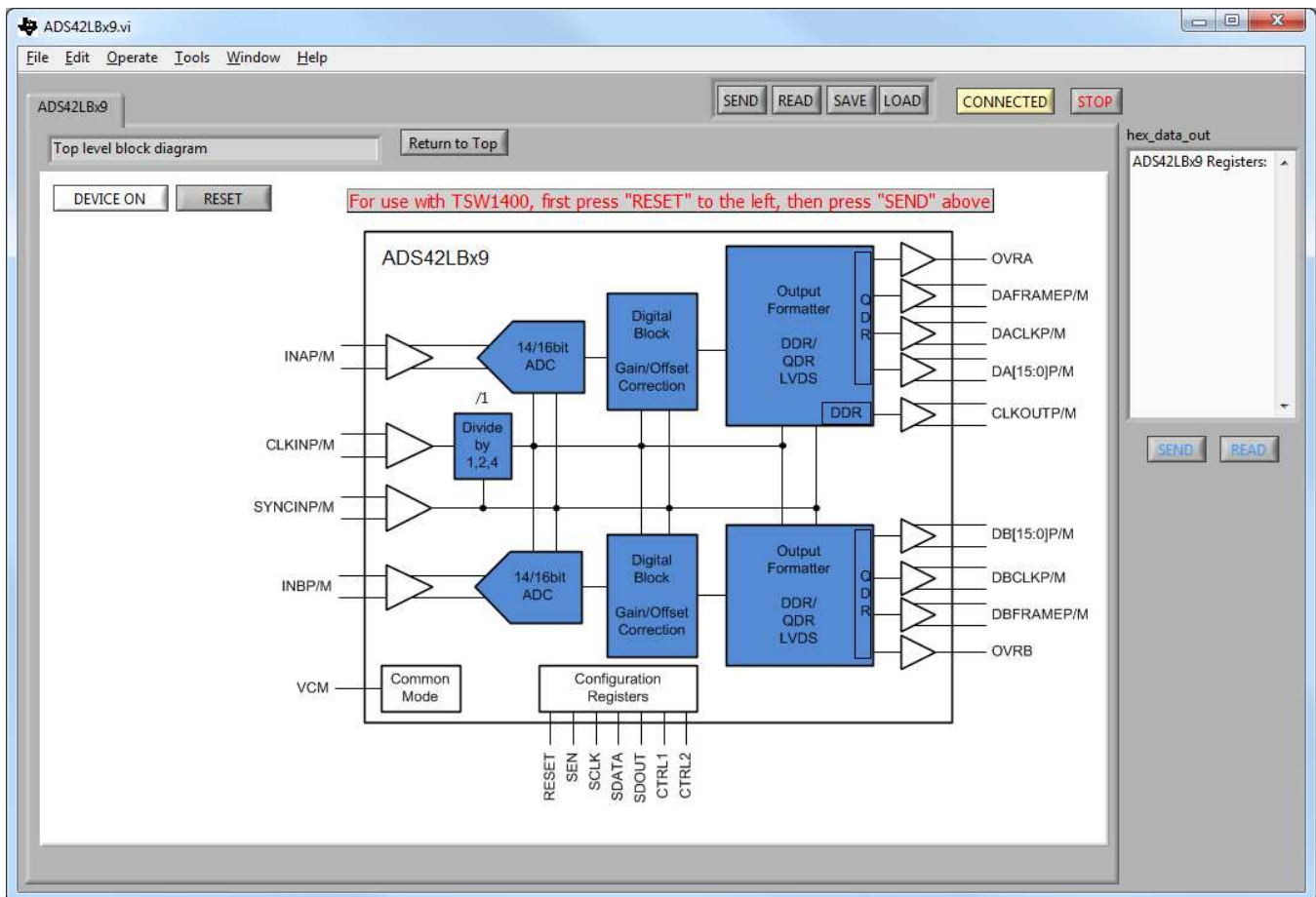

Figure 2. Top-Level Block Diagram Window of the ADS42LBx9 GUI

2.2.2 ADC Controls

Clicking on either *14 or 16bit ADC* block takes the user to the *ADC Controls* window, shown in [Figure 3](#). The *ADC Controls* window controls various ADC functions such as the data format, overrange detection, and test patterns. [Table 2](#) describes the controls seen in this window. Select the **Return to Top** button to return to the top-level block diagram.

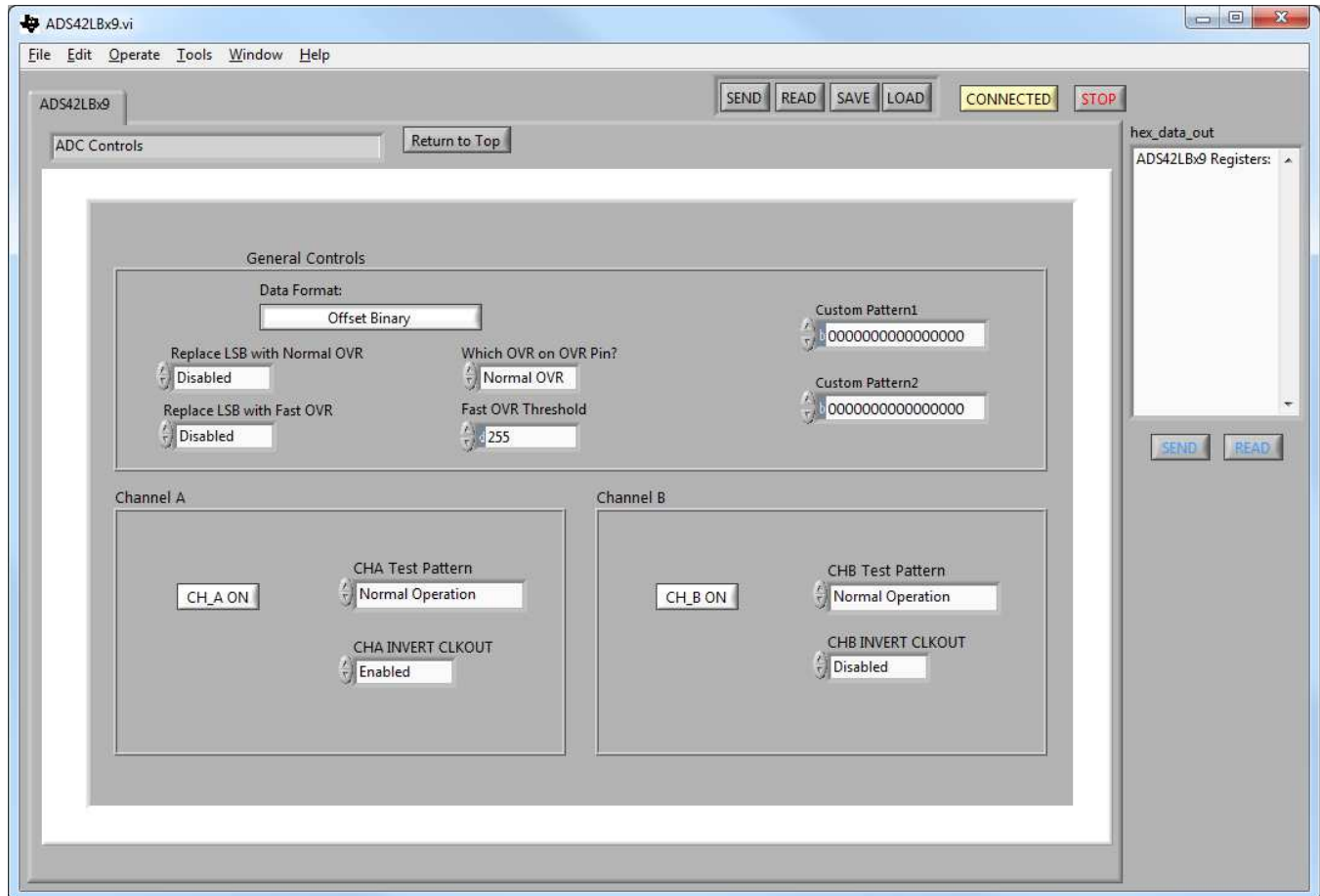

Figure 3. ADC Controls Window of the ADS42LBx9 GUI

Table 2. ADC Controls Window Descriptions

Control	Description
Data Format	Set the output data format as offset binary or 2's compliment
Replace LSB with Normal OVR	Use the LSB as the normal OVR output
Replace LSB with Fast OVR	Use the LSB as the fast OVR output
Which OVR on OVR Pin?	Select which OVR signal should be output on the OVR pin
Fast OVR Threshold	Set the threshold for the fast OVR function
Custom Pattern1	Write a custom test pattern here
Custom Pattern2	Write a custom test pattern here
CH_A ON	Turn on and off channel A
CHA Test Pattern	Select various test pattern modes for channel A
CHA INVERT CLKOUT	Invert the channel A output clock when in 2xDDR mode
CH_B ON	Turn on and off channel B
CHB Test Pattern	Select various test pattern modes for channel B
CHB INVERT CLKOUT	Invert the channel B output clock when in 2xDDR mode

2.2.3 Digital Block Controls

Clicking on either *Digital Block* region brings up the *Digital Block Controls* window, shown in [Figure 4](#). Descriptions for the various controls are given in [Table 3](#).

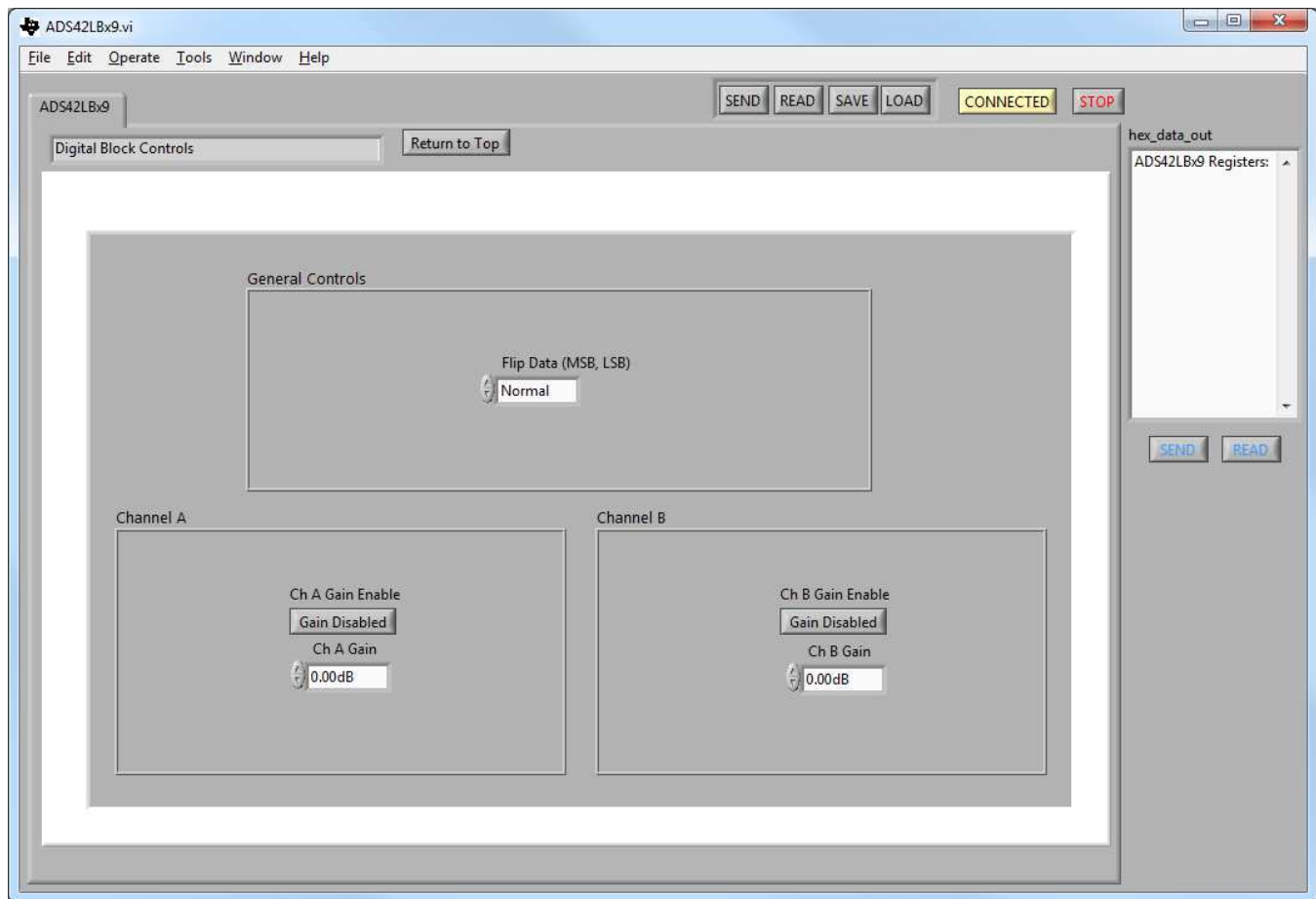

Figure 4. Digital Block Controls Window of the ADS42LBx9 GUI

Table 3. Digital Block Controls Window Descriptions

Control	Description
Flip Data (MSB, LSB)	Reverse the order of the digital output bits, such that the MSB changes to the LSB pin
Ch A Gain Enable	Enable or disable the gain feature of channel A
Ch A Gain	Set the gain of channel A
Ch B Gain Enable	Enable or disable the gain feature of channel B
Ch B Gain	Set the gain of channel B

2.2.4 LVDS Controls

Clicking on either *Output Formatter* block opens the *LVDS Controls* window, shown in [Figure 5](#). Descriptions for the various controls are given in [Table 4](#).

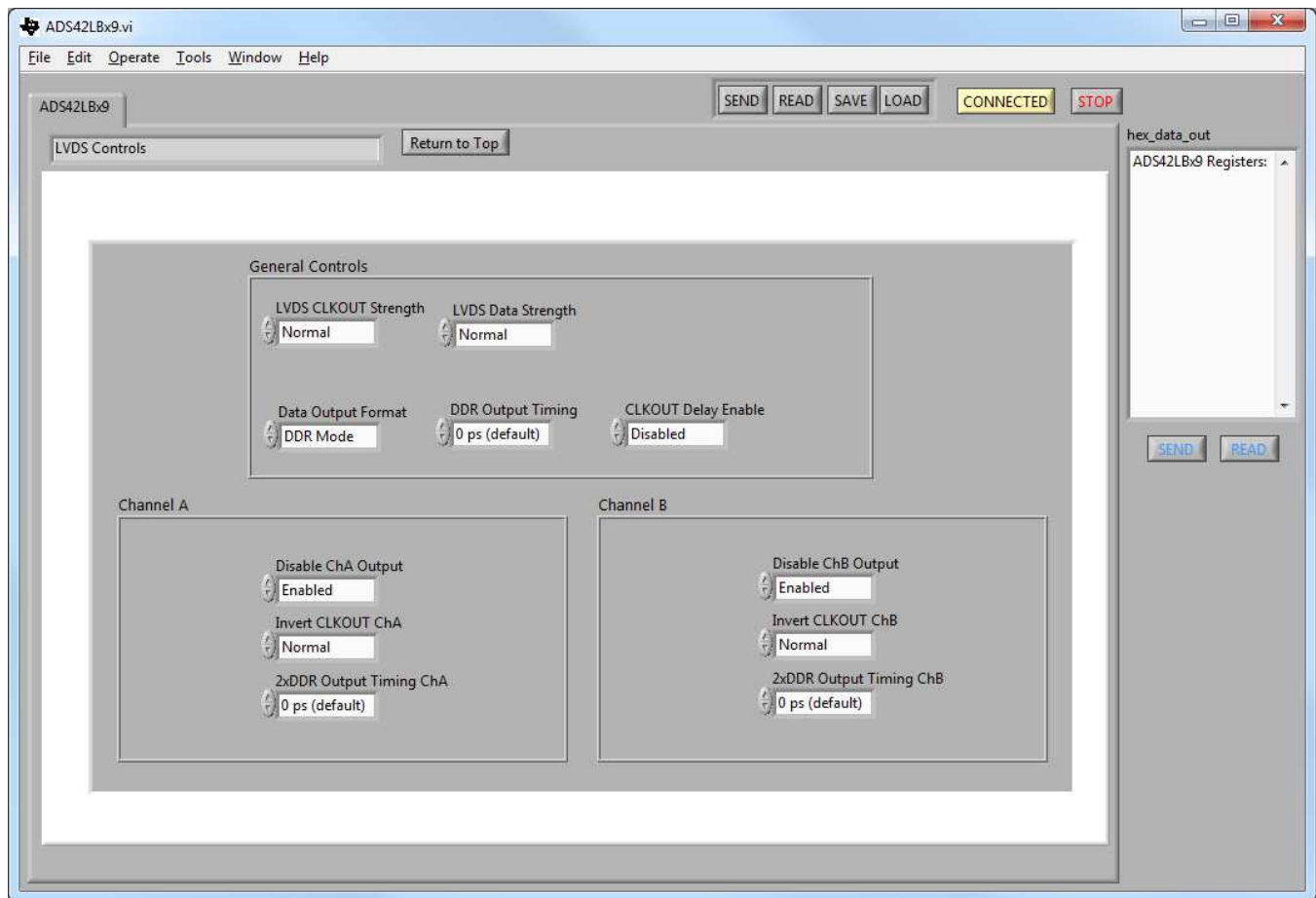

Figure 5. LVDS Controls Window of the ADS42LBx9 GUI

Table 4. LVDS Controls Window Descriptions

Control	Description
LVDS CLKOUT Strength	Set the strength of the LVDS data output clock
LVDS Data Strength	Set the strength of the LVDS data outputs
Data Output Format	Set the data output format as DDR mode or 2xDDR mode
DDR Output Timing	Shift the clock edge relative to the data edge
CLKOUT Delay Enable	Enable or disable the DDR output timing adjustment
Disable ChA Output	Disable the output buffer of channel A
Invert CLKOUT ChA	Invert the clock output of channel A in 2xDDR mode
2xDDR Output Timing ChA	Shift the channel A clkout to data timing in 2xDDR mode
Disable ChB Output	Disable the output buffer of channel B
Invert CLKOUT ChB	Invert the clock output of channel B in 2xDDR mode
2xDDR Output Timing ChB	Shift the channel B clkout to data timing in 2xDDR mode

3 Basic Test Setup

This section outlines basic testing of the ADS42LBx9EVM.

3.1 Test Block Diagram

The test setup for the ADS42LBx9EVM is shown in Figure 6. The TSW1400EVM is used to capture data from the ADS42LBx9, which is then transferred to the computer for analysis in the HSDCPro software tool. The analog signal source shown is an HP8644B signal generator, however any analog signal source can be used. The clock source is also an HP8644B, but other clock sources can be used, such as a TI clock-chip EVM. Note that there are filters on both the analog and clock sources, which is necessary to achieve the best performance.

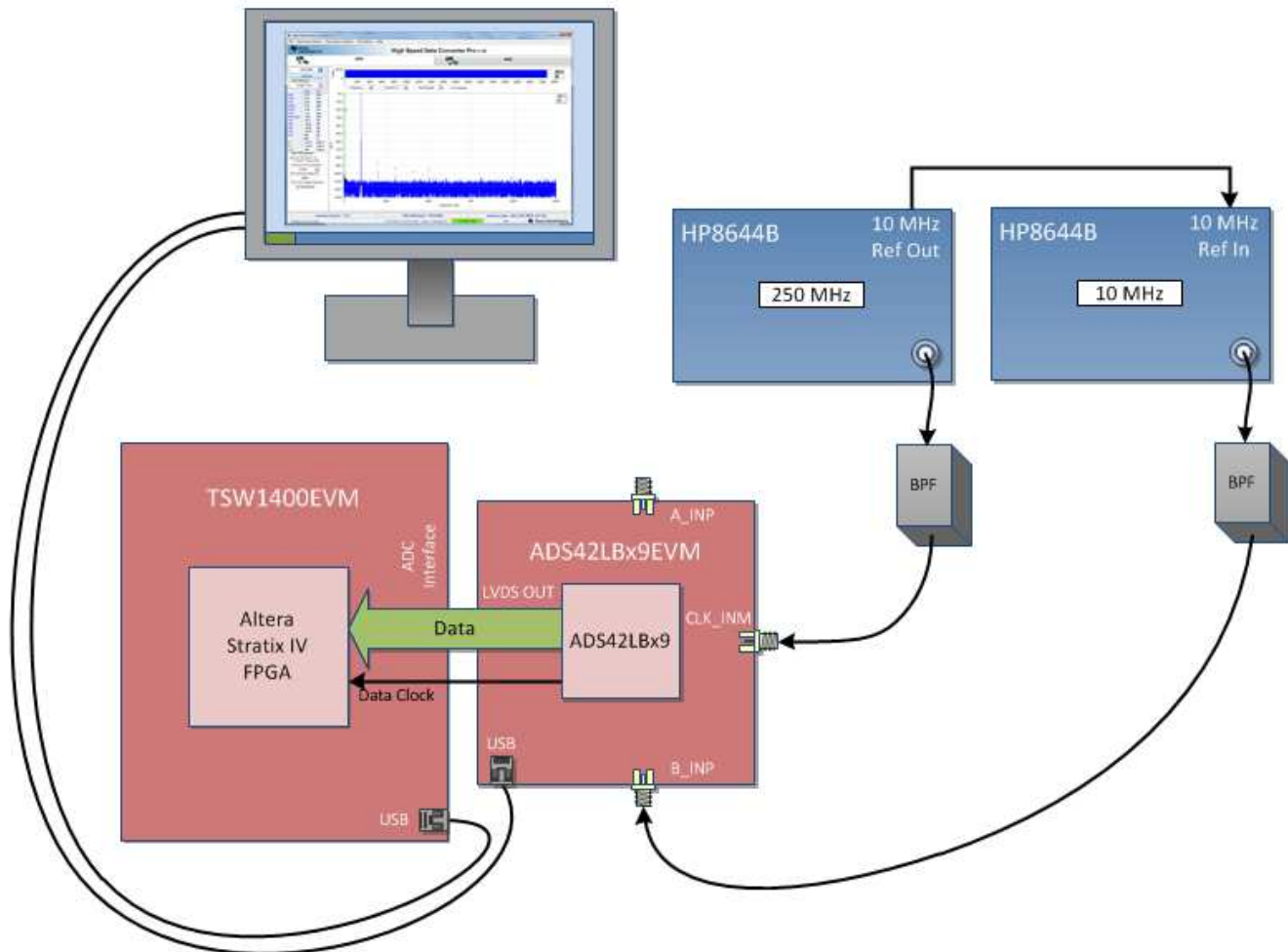

Figure 6. Quick Start Test Setup for the ADS42LBx9EVM

3.2 TSW1400EVM Setup

See the TSW1400EVM User's Guide ([SLWU079](http://www.ti.com/lit/ug/slwu079)) for a more detailed explanation of the TSW1400 setup and its features. This document assumes that the HSDCPro software and the TSW1400 pattern capture and generation board are both installed and functioning properly. This information can be found at <http://www.ti.com/tool/tsw1400evm>.

3.3 ADS42LBx9EVM Quick-Start Procedure

3.3.1 TSW1400 Data Capture Card

1. Connect a 5-V power supply to connector *J12* of the TSW1400EVM.
2. Flip switch *SW7* to the *ON* position.
3. Insert a USB cable into the USB port on the TSW1400. Connect the other end to the PC.

3.3.2 ADS42LBx9EVM

1. Connect a 3.3-V power supply to the banana jacks, *J8* and *J9*. Connect the positive end to *J8* and the negative end to *J9*.
2. Connect a USB cable to the USB port on the ADS42LBx9EVM and connect the other end to the PC.
3. Connect a clock to the SMA connector labeled *CLK_INM*. The maximum clock frequency is 250 MHz and the clock should be around 1 Vpp. A smaller voltage may reduce the SNR performance. A bandpass filter should be placed on the clock in order to achieve the best SNR performance.
4. Connect a signal source to either analog input SMA connector, *A_INP* or *B_INM*. For single-tone testing, a bandpass filter should be used to achieve the best SNR and harmonic performance.
5. Connect the ADS42LBx9EVM to the TSW1400 by connecting *J7* on the ADS42LBx9EVM to the ADC Interface connector on the bottom of the TSW1400.
6. Press the *RESET* switch, *SW1*.

3.3.3 ADS42LBx9 GUI

1. Start the ADS42LBx9 GUI by selecting **Start Menu** → **Program Files** → **Texas Instruments ADCs** → **ADS42LBx9 GUI**.
2. In the upper right-hand corner is either a flashing red and yellow button showing *RESET* or a yellow button that says *CONNECTED*. If it says *RESET*, then click the button until it reads *CONNECTED* and stops flashing. This indicates that the ADS42LBx9EVM is connected to the computer.
3. By default, the GUI controls are setup for use with the TSW1400. In order to program it in the correct mode, first press the **RESET** button to the top-left of the block diagram ([Figure 2](#)).
4. Pressing the **SEND** button at the top of the GUI, sends all the registers. By default, this puts the ADC into the DDR output format and into offset binary mode.

3.3.4 High Speed Data Converter Pro (HSDCPro)

1. Start the HSDCPro software tool by selecting **Start Menu** → **All Programs** → **Texas Instruments ADCs** → **High Speed Data Converter Pro**.
2. When prompted for the serial number of the board, select the serial number that represents the TSW1400 that has been connected to the ADS42LBx9. This number is on a sticker on the TSW1400 board.
3. In the *Select ADC* drop-down box select either *ADS42LB49* or *ADS42LB69*, depending on which EVM is being used. If it asks to download the firmware, select *Yes*. Multiple LEDs light up on the TSW1400, once the firmware has finished downloading.
4. Select *Single Tone* from the *Test Selection* drop-down menu.
5. At the bottom-left corner, enter *250M* in the *ADC Sampling Rate (Fs)* box, or another value if a clock other than 250 MHz is used. Enter the input frequency into the *ADC Input Target Frequency* box. Press the Enter key.
6. If a windowing function is desired, then *Blackman* should be selected above the plot window. If the signals are synchronized and coherent, select *Rectangular*.
7. All boards and software are now setup. Click the *Capture* button. A sample capture is shown in [Figure 7](#) for the ADS42LB69 with a 250-MHz clock and 10-MHz input frequency.

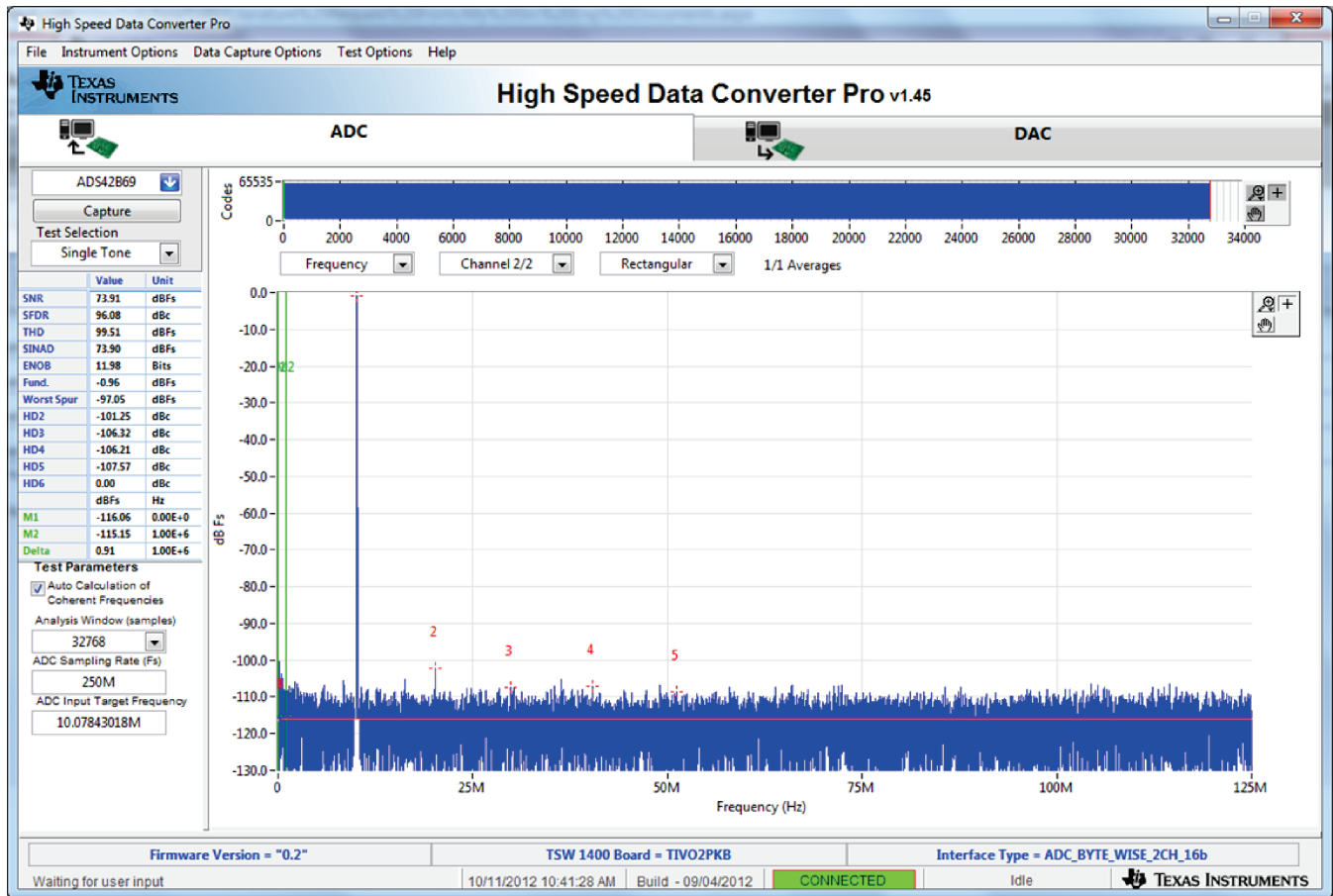

Figure 7. ADS42LB69 Sample Capture using the TSW1400

EVALUATION BOARD/KIT/MODULE (EVM) ADDITIONAL TERMS

Texas Instruments (TI) provides the enclosed Evaluation Board/Kit/Module (EVM) under the following conditions:

The user assumes all responsibility and liability for proper and safe handling of the goods. Further, the user indemnifies TI from all claims arising from the handling or use of the goods.

Should this evaluation board/kit not meet the specifications indicated in the User's Guide, the board/kit may be returned within 30 days from the date of delivery for a full refund. THE FOREGOING LIMITED WARRANTY IS THE EXCLUSIVE WARRANTY MADE BY SELLER TO BUYER AND IS IN LIEU OF ALL OTHER WARRANTIES, EXPRESSED, IMPLIED, OR STATUTORY, INCLUDING ANY WARRANTY OF MERCHANTABILITY OR FITNESS FOR ANY PARTICULAR PURPOSE. EXCEPT TO THE EXTENT OF THE INDEMNITY SET FORTH ABOVE, NEITHER PARTY SHALL BE LIABLE TO THE OTHER FOR ANY INDIRECT, SPECIAL, INCIDENTAL, OR CONSEQUENTIAL DAMAGES.

Please read the User's Guide and, specifically, the Warnings and Restrictions notice in the User's Guide prior to handling the product. This notice contains important safety information about temperatures and voltages. For additional information on TI's environmental and/or safety programs, please visit www.ti.com/esh or contact TI.

No license is granted under any patent right or other intellectual property right of TI covering or relating to any machine, process, or combination in which such TI products or services might be or are used. TI currently deals with a variety of customers for products, and therefore our arrangement with the user is not exclusive. TI assumes no liability for applications assistance, customer product design, software performance, or infringement of patents or services described herein.

REGULATORY COMPLIANCE INFORMATION

As noted in the EVM User's Guide and/or EVM itself, this EVM and/or accompanying hardware may or may not be subject to the Federal Communications Commission (FCC) and Industry Canada (IC) rules.

For EVMs **not** subject to the above rules, this evaluation board/kit/module is intended for use for ENGINEERING DEVELOPMENT, DEMONSTRATION OR EVALUATION PURPOSES ONLY and is not considered by TI to be a finished end product fit for general consumer use. It generates, uses, and can radiate radio frequency energy and has not been tested for compliance with the limits of computing devices pursuant to part 15 of FCC or ICES-003 rules, which are designed to provide reasonable protection against radio frequency interference. Operation of the equipment may cause interference with radio communications, in which case the user at his own expense will be required to take whatever measures may be required to correct this interference.

General Statement for EVMs including a radio

User Power/Frequency Use Obligations: This radio is intended for development/professional use only in legally allocated frequency and power limits. Any use of radio frequencies and/or power availability of this EVM and its development application(s) must comply with local laws governing radio spectrum allocation and power limits for this evaluation module. It is the user's sole responsibility to only operate this radio in legally acceptable frequency space and within legally mandated power limitations. Any exceptions to this are strictly prohibited and unauthorized by Texas Instruments unless user has obtained appropriate experimental/development licenses from local regulatory authorities, which is responsibility of user including its acceptable authorization.

For EVMs annotated as FCC – FEDERAL COMMUNICATIONS COMMISSION Part 15 Compliant

Caution

This device complies with part 15 of the FCC Rules. Operation is subject to the following two conditions: (1) This device may not cause harmful interference, and (2) this device must accept any interference received, including interference that may cause undesired operation.

Changes or modifications not expressly approved by the party responsible for compliance could void the user's authority to operate the equipment.

FCC Interference Statement for Class A EVM devices

This equipment has been tested and found to comply with the limits for a Class A digital device, pursuant to part 15 of the FCC Rules. These limits are designed to provide reasonable protection against harmful interference when the equipment is operated in a commercial environment. This equipment generates, uses, and can radiate radio frequency energy and, if not installed and used in accordance with the instruction manual, may cause harmful interference to radio communications. Operation of this equipment in a residential area is likely to cause harmful interference in which case the user will be required to correct the interference at his own expense.

FCC Interference Statement for Class B EVM devices

This equipment has been tested and found to comply with the limits for a Class B digital device, pursuant to part 15 of the FCC Rules. These limits are designed to provide reasonable protection against harmful interference in a residential installation. This equipment generates, uses and can radiate radio frequency energy and, if not installed and used in accordance with the instructions, may cause harmful interference to radio communications. However, there is no guarantee that interference will not occur in a particular installation. If this equipment does cause harmful interference to radio or television reception, which can be determined by turning the equipment off and on, the user is encouraged to try to correct the interference by one or more of the following measures:

- Reorient or relocate the receiving antenna.
- Increase the separation between the equipment and receiver.
- Connect the equipment into an outlet on a circuit different from that to which the receiver is connected.
- Consult the dealer or an experienced radio/TV technician for help.

For EVMs annotated as IC – INDUSTRY CANADA Compliant

This Class A or B digital apparatus complies with Canadian ICES-003.

Changes or modifications not expressly approved by the party responsible for compliance could void the user's authority to operate the equipment.

Concerning EVMs including radio transmitters

This device complies with Industry Canada licence-exempt RSS standard(s). Operation is subject to the following two conditions: (1) this device may not cause interference, and (2) this device must accept any interference, including interference that may cause undesired operation of the device.

Concerning EVMs including detachable antennas

Under Industry Canada regulations, this radio transmitter may only operate using an antenna of a type and maximum (or lesser) gain approved for the transmitter by Industry Canada. To reduce potential radio interference to other users, the antenna type and its gain should be so chosen that the equivalent isotropically radiated power (e.i.r.p.) is not more than that necessary for successful communication.

This radio transmitter has been approved by Industry Canada to operate with the antenna types listed in the user guide with the maximum permissible gain and required antenna impedance for each antenna type indicated. Antenna types not included in this list, having a gain greater than the maximum gain indicated for that type, are strictly prohibited for use with this device.

Cet appareil numérique de la classe A ou B est conforme à la norme NMB-003 du Canada.

Les changements ou les modifications pas expressément approuvés par la partie responsable de la conformité ont pu vider l'autorité de l'utilisateur pour actionner l'équipement.

Concernant les EVMs avec appareils radio

Le présent appareil est conforme aux CNR d'Industrie Canada applicables aux appareils radio exempts de licence. L'exploitation est autorisée aux deux conditions suivantes : (1) l'appareil ne doit pas produire de brouillage, et (2) l'utilisateur de l'appareil doit accepter tout brouillage radioélectrique subi, même si le brouillage est susceptible d'en compromettre le fonctionnement.

Concernant les EVMs avec antennes détachables

Conformément à la réglementation d'Industrie Canada, le présent émetteur radio peut fonctionner avec une antenne d'un type et d'un gain maximal (ou inférieur) approuvé pour l'émetteur par Industrie Canada. Dans le but de réduire les risques de brouillage radioélectrique à l'intention des autres utilisateurs, il faut choisir le type d'antenne et son gain de sorte que la puissance isotrope rayonnée équivalente (p.i.r.e.) ne dépasse pas l'intensité nécessaire à l'établissement d'une communication satisfaisante.

Le présent émetteur radio a été approuvé par Industrie Canada pour fonctionner avec les types d'antenne énumérés dans le manuel d'usage et ayant un gain admissible maximal et l'impédance requise pour chaque type d'antenne. Les types d'antenne non inclus dans cette liste, ou dont le gain est supérieur au gain maximal indiqué, sont strictement interdits pour l'exploitation de l'émetteur.

【Important Notice for Users of this Product in Japan】

This development kit is NOT certified as Confirming to Technical Regulations of Radio Law of Japan

If you use this product in Japan, you are required by Radio Law of Japan to follow the instructions below with respect to this product:

1. Use this product in a shielded room or any other test facility as defined in the notification #173 issued by Ministry of Internal Affairs and Communications on March 28, 2006, based on Sub-section 1.1 of Article 6 of the Ministry's Rule for Enforcement of Radio Law of Japan,
2. Use this product only after you obtained the license of Test Radio Station as provided in Radio Law of Japan with respect to this product, or
3. Use of this product only after you obtained the Technical Regulations Conformity Certification as provided in Radio Law of Japan with respect to this product. Also, please do not transfer this product, unless you give the same notice above to the transferee. Please note that if you could not follow the instructions above, you will be subject to penalties of Radio Law of Japan.

Texas Instruments Japan Limited
(address) 24-1, Nishi-Shinjuku 6 chome, Shinjuku-ku, Tokyo, Japan

<http://www.tij.co.jp>

【ご使用にあたっての注】

本開発キットは技術基準適合証明を受けておりません。

本製品のご使用に際しては、電波法遵守のため、以下のいずれかの措置を取っていただく必要がありますのでご注意ください。

1. 電波法施行規則第6条第1項第1号に基づく平成18年3月28日総務省告示第173号で定められた電波暗室等の試験設備でご使用いただく。
2. 実験局の免許を取得後ご使用いただく。
3. 技術基準適合証明を取得後ご使用いただく。

なお、本製品は、上記の「ご使用にあたっての注意」を譲渡先、移転先に通知しない限り、譲渡、移転できないものとします。

上記を遵守頂けない場合は、電波法の罰則が適用される可能性があることをご留意ください。

日本テキサス・インスツルメンツ株式会社
東京都新宿区西新宿6丁目24番1号
西新宿三井ビル

<http://www.tij.co.jp>

EVALUATION BOARD/KIT/MODULE (EVM) WARNINGS, RESTRICTIONS AND DISCLAIMERS

For Feasibility Evaluation Only, in Laboratory/Development Environments. Unless otherwise indicated, this EVM is not a finished electrical equipment and not intended for consumer use. It is intended solely for use for preliminary feasibility evaluation in laboratory/development environments by technically qualified electronics experts who are familiar with the dangers and application risks associated with handling electrical mechanical components, systems and subsystems. It should not be used as all or part of a finished end product.

Your Sole Responsibility and Risk. You acknowledge, represent and agree that:

1. You have unique knowledge concerning Federal, State and local regulatory requirements (including but not limited to Food and Drug Administration regulations, if applicable) which relate to your products and which relate to your use (and/or that of your employees, affiliates, contractors or designees) of the EVM for evaluation, testing and other purposes.
2. You have full and exclusive responsibility to assure the safety and compliance of your products with all such laws and other applicable regulatory requirements, and also to assure the safety of any activities to be conducted by you and/or your employees, affiliates, contractors or designees, using the EVM. Further, you are responsible to assure that any interfaces (electronic and/or mechanical) between the EVM and any human body are designed with suitable isolation and means to safely limit accessible leakage currents to minimize the risk of electrical shock hazard.
3. You will employ reasonable safeguards to ensure that your use of the EVM will not result in any property damage, injury or death, even if the EVM should fail to perform as described or expected.
4. You will take care of proper disposal and recycling of the EVM's electronic components and packing materials.

Certain Instructions. It is important to operate this EVM within TI's recommended specifications and environmental considerations per the user guidelines. Exceeding the specified EVM ratings (including but not limited to input and output voltage, current, power, and environmental ranges) may cause property damage, personal injury or death. If there are questions concerning these ratings please contact a TI field representative prior to connecting interface electronics including input power and intended loads. Any loads applied outside of the specified output range may result in unintended and/or inaccurate operation and/or possible permanent damage to the EVM and/or interface electronics. Please consult the EVM User's Guide prior to connecting any load to the EVM output. If there is uncertainty as to the load specification, please contact a TI field representative. During normal operation, some circuit components may have case temperatures greater than 60°C as long as the input and output are maintained at a normal ambient operating temperature. These components include but are not limited to linear regulators, switching transistors, pass transistors, and current sense resistors which can be identified using the EVM schematic located in the EVM User's Guide. When placing measurement probes near these devices during normal operation, please be aware that these devices may be very warm to the touch. As with all electronic evaluation tools, only qualified personnel knowledgeable in electronic measurement and diagnostics normally found in development environments should use these EVMs.

Agreement to Defend, Indemnify and Hold Harmless. You agree to defend, indemnify and hold TI, its licensors and their representatives harmless from and against any and all claims, damages, losses, expenses, costs and liabilities (collectively, "Claims") arising out of or in connection with any use of the EVM that is not in accordance with the terms of the agreement. This obligation shall apply whether Claims arise under law of tort or contract or any other legal theory, and even if the EVM fails to perform as described or expected.

Safety-Critical or Life-Critical Applications. If you intend to evaluate the components for possible use in safety critical applications (such as life support) where a failure of the TI product would reasonably be expected to cause severe personal injury or death, such as devices which are classified as FDA Class III or similar classification, then you must specifically notify TI of such intent and enter into a separate Assurance and Indemnity Agreement.

Mailing Address: Texas Instruments, Post Office Box 655303, Dallas, Texas 75265
Copyright © 2012, Texas Instruments Incorporated

IMPORTANT NOTICE

Texas Instruments Incorporated and its subsidiaries (TI) reserve the right to make corrections, enhancements, improvements and other changes to its semiconductor products and services per JESD46, latest issue, and to discontinue any product or service per JESD48, latest issue. Buyers should obtain the latest relevant information before placing orders and should verify that such information is current and complete. All semiconductor products (also referred to herein as "components") are sold subject to TI's terms and conditions of sale supplied at the time of order acknowledgment.

TI warrants performance of its components to the specifications applicable at the time of sale, in accordance with the warranty in TI's terms and conditions of sale of semiconductor products. Testing and other quality control techniques are used to the extent TI deems necessary to support this warranty. Except where mandated by applicable law, testing of all parameters of each component is not necessarily performed.

TI assumes no liability for applications assistance or the design of Buyers' products. Buyers are responsible for their products and applications using TI components. To minimize the risks associated with Buyers' products and applications, Buyers should provide adequate design and operating safeguards.

TI does not warrant or represent that any license, either express or implied, is granted under any patent right, copyright, mask work right, or other intellectual property right relating to any combination, machine, or process in which TI components or services are used. Information published by TI regarding third-party products or services does not constitute a license to use such products or services or a warranty or endorsement thereof. Use of such information may require a license from a third party under the patents or other intellectual property of the third party, or a license from TI under the patents or other intellectual property of TI.

Reproduction of significant portions of TI information in TI data books or data sheets is permissible only if reproduction is without alteration and is accompanied by all associated warranties, conditions, limitations, and notices. TI is not responsible or liable for such altered documentation. Information of third parties may be subject to additional restrictions.

Resale of TI components or services with statements different from or beyond the parameters stated by TI for that component or service voids all express and any implied warranties for the associated TI component or service and is an unfair and deceptive business practice. TI is not responsible or liable for any such statements.

Buyer acknowledges and agrees that it is solely responsible for compliance with all legal, regulatory and safety-related requirements concerning its products, and any use of TI components in its applications, notwithstanding any applications-related information or support that may be provided by TI. Buyer represents and agrees that it has all the necessary expertise to create and implement safeguards which anticipate dangerous consequences of failures, monitor failures and their consequences, lessen the likelihood of failures that might cause harm and take appropriate remedial actions. Buyer will fully indemnify TI and its representatives against any damages arising out of the use of any TI components in safety-critical applications.

In some cases, TI components may be promoted specifically to facilitate safety-related applications. With such components, TI's goal is to help enable customers to design and create their own end-product solutions that meet applicable functional safety standards and requirements. Nonetheless, such components are subject to these terms.

No TI components are authorized for use in FDA Class III (or similar life-critical medical equipment) unless authorized officers of the parties have executed a special agreement specifically governing such use.

Only those TI components which TI has specifically designated as military grade or "enhanced plastic" are designed and intended for use in military/aerospace applications or environments. Buyer acknowledges and agrees that any military or aerospace use of TI components which have **not** been so designated is solely at the Buyer's risk, and that Buyer is solely responsible for compliance with all legal and regulatory requirements in connection with such use.

TI has specifically designated certain components which meet ISO/TS16949 requirements, mainly for automotive use. Components which have not been so designated are neither designed nor intended for automotive use; and TI will not be responsible for any failure of such components to meet such requirements.

Products

Audio	www.ti.com/audio
Amplifiers	amplifier.ti.com
Data Converters	dataconverter.ti.com
DLP® Products	www.dlp.com
DSP	dsp.ti.com
Clocks and Timers	www.ti.com/clocks
Interface	interface.ti.com
Logic	logic.ti.com
Power Mgmt	power.ti.com
Microcontrollers	microcontroller.ti.com
RFID	www.ti-rfid.com
OMAP Applications Processors	www.ti.com/omap
Wireless Connectivity	www.ti.com/wirelessconnectivity

Applications

Automotive and Transportation	www.ti.com/automotive
Communications and Telecom	www.ti.com/communications
Computers and Peripherals	www.ti.com/computers
Consumer Electronics	www.ti.com/consumer-apps
Energy and Lighting	www.ti.com/energy
Industrial	www.ti.com/industrial
Medical	www.ti.com/medical
Security	www.ti.com/security
Space, Avionics and Defense	www.ti.com/space-avionics-defense
Video and Imaging	www.ti.com/video

TI E2E Community

e2e.ti.com