

## ADS1256EVM and ADS1256EVM-PDK

---

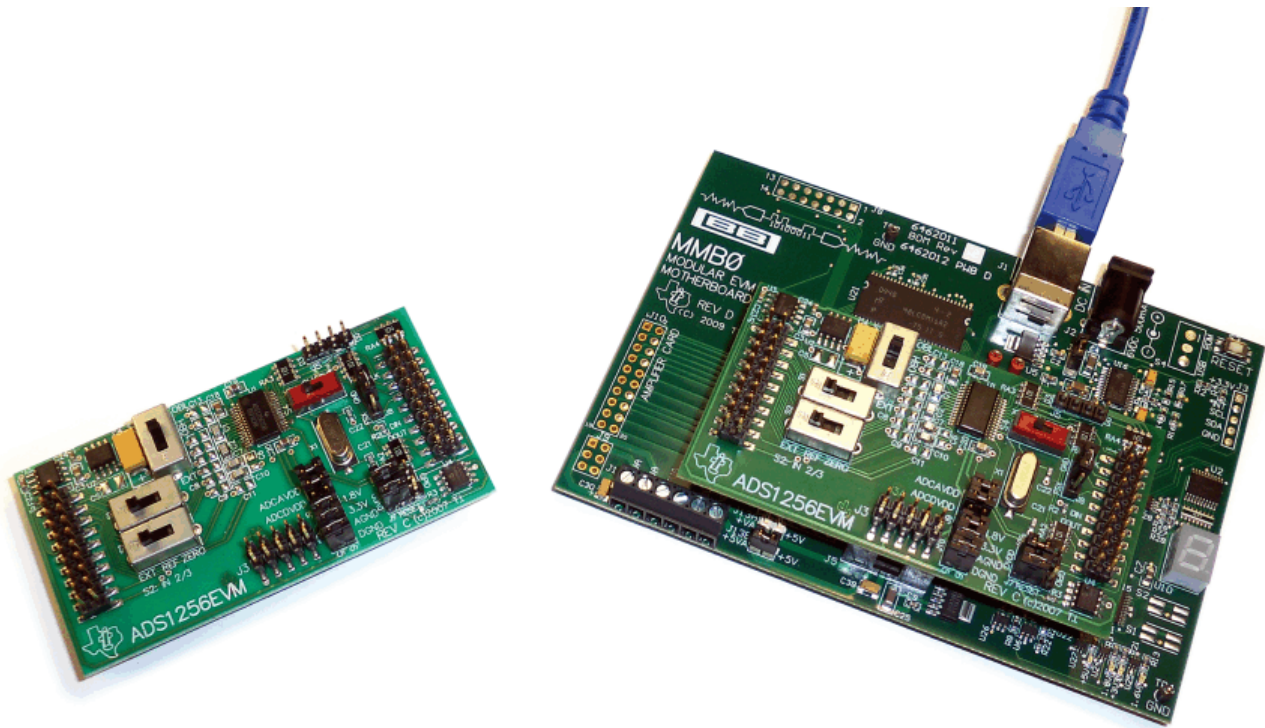

---



This user's guide describes the characteristics, operation, and use of the ADS1256EVM, both by itself and as part of the ADS1256EVM-PDK. This EVM is an evaluation fixture for the [ADS1256](#) 24-bit delta-sigma ( $\Delta\Sigma$ ) analog-to-digital converter (ADC). It also serves as an evaluation platform for the [ADS1255](#), which is a proper subset of the ADS1256. It allows evaluation of all aspects of the ADS1256 device. A complete circuit description, schematic diagram, and bill of materials are included.

The following related documents are available through the Texas Instruments web site at [www.ti.com](http://www.ti.com).

Device	Literature Number
<a href="#">ADS1256</a>	<a href="#">SBAS288</a>
<a href="#">REF5025</a>	<a href="#">SBOS410</a>
<a href="#">OPA350</a>	<a href="#">SBOS099</a>

## Contents

1	EVM Overview .....	3
2	Analog Interface.....	6
3	Digital Interface .....	7
4	Power Supplies .....	8
5	Voltage Reference .....	10
6	Clock Source.....	11
7	EVM Operation .....	12
8	ADS1256EVM-PDK Kit Operation .....	15
9	Evaluating Performance with the ADCPro Software.....	30
10	Schematics and Layout.....	38

## List of Figures

1	ADS1256EVM.....	5
2	GPIO Pins .....	8
3	Jumper Block.....	9
4	Switch S3.....	10
5	Switch S4.....	11
6	Switches S1 and S2 .....	12
7	ADS1256EVM Default Jumper and Switch Locations.....	14
8	ADS1256EVM-PDK Setup Wizard.....	16
9	ADS1256EVM-PDK License Agreement.....	16
10	ADS1256EVM-PDK Installation in Progress.....	17
11	ADS1256EVM-PDK Installation Complete .....	17
12	MMB0 Initial Configuration .....	18
13	Connecting the ADS1256EVM to the MMB0 .....	19
14	MMB0 Powered From AC Adapter.....	20
15	MMB0 Configured for Lab Power Supply .....	21
16	NI-VISA Driver Installation Wizard, Screen 1.....	22
17	NI-VISA Driver Installation Wizard, Screen 2.....	23
18	NI-VISA Driver Installation Wizard, Screen 3.....	23
19	NI-VISA Driver Installation Wizard, Screen 4.....	24
20	NI-VISA Driver Verification Using Device Manager.....	25
21	ADCPro Software Start-up Display Window .....	25
22	ADS1256EVM-PDK Plug-In Display Window .....	26
23	Install New Driver Wizard Screen 1.....	27
24	Install New Driver Wizard Screen 2.....	27
25	Install New Driver Wizard Screen 3.....	28
26	Install New Driver Wizard Screen 4.....	28
27	Install New Driver Wizard Screen 5.....	29
28	USBStyx Driver Verification Using Device Manager.....	29
29	ADS1256EVM-PDK Plug-In Averages, PGA Gain, and Effective Data Rate Controls .....	30
30	MUX Tab .....	31
31	Clocks Tab .....	32
32	GPIO Tab .....	33
33	Power & Ref Tab .....	34
34	Cal Tab .....	35
35	EVM Software About Tab .....	36
36	Software Progress Indicator .....	37

37	ADS1256EVM PCB: Top-Side Image .....	39
38	ADS1256EVM PCB: Layer 1 .....	39
39	ADS1256EVM PCB: Layer 2 .....	39
40	ADS1256EVM PCB: Bottom-Side Image .....	39
41	Schematic .....	40

### List of Tables

1	J1: Analog Interface Pinout.....	6
2	J2: Serial Interface Pins.....	7
3	J5: GPIO Header Pins .....	8
4	J5 Configuration: Power-Supply Input .....	8
5	J4, J9, and J10 Configuration: Power Options .....	10
6	Reference Input Select Switch .....	11
7	System Clock Select Switch .....	11
8	AIN0-1 Input Select Switch (S1).....	12
9	AIN2-3 Input Select Switch (S2).....	13
10	Default Jumper Positions.....	14
11	Default Switch Positions.....	15
12	ADS1256EVM Bill of Materials .....	38

## Trademarks

ADCPro is a trademark of Texas Instruments.  
 Microsoft, Windows are registered trademarks of Microsoft Corporation.  
 I<sup>2</sup>C is a trademark of NXP Semiconductors.  
 NI-VISA is a trademark of National Instruments.  
 All other trademarks are the property of their respective owners.

## 1 EVM Overview

The ADS1256EVM is an evaluation fixture for the ADS1256 24-bit delta-sigma ADC.

### 1.1 Features

#### ADS1256EVM Features:

- Contains all support circuitry needed for the ADS1256
- Voltage reference options: off-board reference, or buffered REF5025 with high or low common-mode voltage
- Compatible with the TI Modular EVM System

#### ADS1256EVM-PDK Features:

- Easy-to-use evaluation software for Microsoft® Windows®
- Data collection to ASCII text files
- Built-in analysis tools including scope, FFT, and histogram displays
- Complete control of board settings
- Easily expandable with new analysis plug-in tools from Texas Instruments

For use with a computer, the ADS1256EVM-PDK is available. This kit combines the ADS1256EVM board with the DSP-based MMB0 motherboard, and includes ADCPro™ software for evaluation.

The MMB0 motherboard allows the ADS1256EVM to be connected to the computer via an available USB port. This manual shows how to use the MMB0 as part of the ADS1256EVM-PDK, but does not provide technical details on the MMB0 itself.

ADCPro is a program for collecting, recording, and analyzing data from ADC evaluation boards. It is based on a number of plug-in programs, so it can be expanded easily with new test and data collection plug-ins. The ADS1256EVM-PDK is controlled by a plug-in that runs in ADCPro. For more information about ADCPro, see the [ADCPro™ Analog-to-Digital Converter Evaluation Software User's Guide](#) (literature number [SBAU128](#)), available for download from the TI website.

This manual covers the operation of both the ADS1256EVM and the ADS1256EVM-PDK. Throughout this document, the abbreviation *EVM* and the term *evaluation module* are synonymous with the ADS1256EVM.

## 1.2 Introduction

The ADS1256EVM, shown in [Figure 1](#), is an evaluation module built to the TI Modular EVM System specification. It can be connected to any Modular EVM System interface card.

The ADS1256EVM is available as a stand-alone printed circuit board (PCB) or as part of the ADS1256EVM-PDK, which includes an MMB0 motherboard and software. As a stand-alone PCB, the ADS1256EVM is useful for prototyping designs and firmware.

Note that the ADS1256EVM has no microprocessor and cannot run software. To connect it to a computer, some type of interface is required.

If you intend to use the ADS1255 in your application, use the ADS1256EVM for evaluation and test purposes. The ADS1255 is in a smaller package, and lacks inputs AIN2 through AIN7; otherwise, it is identical to the ADS1256.

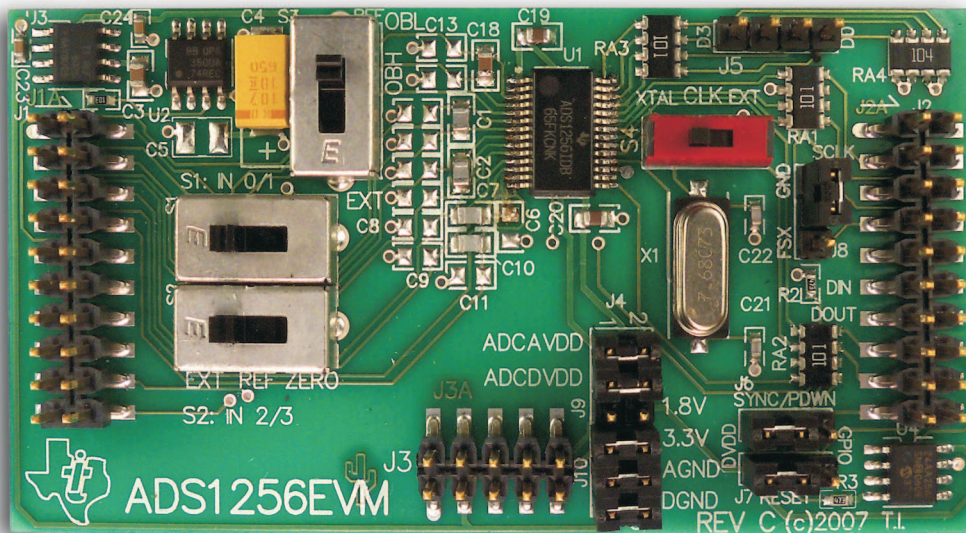

**Figure 1. ADS1256EVM**

## 1.3 Built-In Accessories

The ADS1256EVM includes a system clock crystal and a low-noise voltage reference. Both are optional; you can select an external system clock and an external reference using slide switches.

The +2.5V reference circuit is based on a [REF5025](#) buffered by an [OPA350](#) and filtered by a large tantalum electrolytic capacitor. While its noise performance is not sufficiently low to allow the ADS1256 to perform at its lowest noise level at all data rates, the circuit can closely approach this limit, and is representative of the kind of reference circuit used in many applications.

## 1.4 Connectors

The ADS1256 device on the ADS1256EVM is connected through four headers: the analog connector, the serial connector, the power connector, and the GPIO header. This section describes the respective pinouts and locations for the connectors and header.

The analog connector (J1) carries analog I/O. The ADS1256 has a nine-input multiplexer connected through pins 1 through 8 and 10. An optional external differential reference can be connected to pins 18 and 20.

The serial connector (J2) carries the ADS1256 serial digital interface, an optional external system clock signal, and an I<sup>2</sup>C™ connection to the onboard serial EEPROM.



The power connector (J3) carries the power supplies. The ADS1256EVM requires a +5V analog supply and a +1.8V to +3.3V digital supply. The board is designed using a single ground net connected to DGND. An AGND pin is also provided. Power options are routed through J4, J9, and J10.

The GPIO header (J5) provides a connection to the four GPIO pins on the EVM.

The ADS1256 uses separate supplies for its analog and digital sections. A jumper is inserted in each supply line. These jumpers allow the current of each supply to be measured independently.

## 1.5 Controls

The ADS1256EVM is configured using four slide switches and a jumper.

Switches S1 and S2 select the input signal provided to the first four multiplexer inputs on the ADS1256. Normally you will use the external input, but you can also use the switches to short the inputs together and to connect the reference voltage to the inputs. Additionally, the latter two positions are useful for conducting noise and functional tests.

Switch S3 selects the reference input. One position selects the external reference input pins on the analog connector (J1). The other two positions connect the onboard +2.5V reference in one of two ways: between ground and the reference, or between the reference and the analog supply.

Switch S4 selects the system clock source for the ADS1256. You can select between the onboard 7.68MHz crystal or an external clock.

All switches and their settings are additionally described in later sections of this user guide.

## 2 Analog Interface

For maximum flexibility, the ADS1256EVM is designed for easy interfacing to multiple analog sources. Samtec part numbers SSW-110-22-F-D-VS-K and TSM-110-01-T-DV-P provide a convenient 10-pin, dual-row, header/socket combination at J1. This header/socket provides access to the analog input pins of the ADS1256. Consult Samtec at [www.samtec.com](http://www.samtec.com) or call 1-800-SAMTEC-9 for a variety of mating connector options.

Most of the pins on J1 are directly connected, with minimal filtering or protection. Use appropriate caution when handling these pins. [Table 1](#) summarizes the pinout for analog interface J1.

**Table 1. J1: Analog Interface Pinout**

Pin Number	Pin Name	Standard Name	Direction	Function
J1.1	AIN0	AN0-	Input	Analog input 1 (switched by S1)
J1.2	AIN1	AN0+	Input	Analog input 0 (switched by S1)
J1.3	AIN2	AN1-	Input	Analog input 3 (switched by S1)
J1.4	AIN3	AN1+	Input	Analog input 2 (switched by S1)
J1.5	AIN4	AN2-	Input	Analog input 4
J1.6	AIN5	AN2+	Input	Analog input 5
J1.7	AIN6	AN3-	Input	Analog input 6
J1.8	AIN7	AN3+	Input	Analog input 7
J1.10	AINCOM	AN4+	Input	Analog input common
J1.18	SYSREFN	REF-	Input	Inverting external reference input
J1.20	SYSREFP	REF+	Input	Noninverting external reference input
J1.9-J1.19 odd	GND	AGND	Input	Signal ground

## 3 Digital Interface

### 3.1 Serial Data Interface

The ADS1256EVM is designed to easily interface with multiple control platforms. Samtec part numbers SSW-110-22-F-D-VS-K and TSM-110-01-T-DV-P provide a convenient 10-pin, dual-row, header/socket combination at J2. This header/socket provides access to the digital control and serial data pins of the TSC. Consult Samtec at [www.samtec.com](http://www.samtec.com) or call 1-800-SAMTEC-9 for a variety of mating connector options.

All logic levels on J2 are 3.3V CMOS, except for the I<sup>2</sup>C pins, which conform to 3.3V I<sup>2</sup>C rules.

Some pins on J2 have weak pullup resistors. These resistors provide default settings for many of the control pins. Most pins on J2 correspond directly to ADS1256 pins. See the [ADS1256 product data sheet](#) for complete details on these pins. [Table 2](#) describes the J2 serial interface pins.

**Table 2. J2: Serial Interface Pins**

Pin Number	Pin Name	Standard Name	Direction	Pulldown	Function
J2.1	—	CNTL	—	None	Unused
J2.2	—	GPIO0	—	None	Unused
J2.3	SCLK	CLKX	Input	None	Serial clock input
J2.4	DGND	DGND	I/O	Power	Digital ground
J2.5	—	CLKR	—	None	Unused
J2.6	—	GPIO1	—	None	Unused
J2.7	$\overline{CS}$	FSX	Input	None	Chip select (via J8)
J2.8	—	GPIO2	—	None	Unused
J2.9	—	FSR	—	None	Unused
J2.10	DGND	DGND	I/O	Power	Digital ground
J2.11	DIN	DX	Input	None	Serial data input
J2.12	—	GPIO3	—	None	Unused
J2.13	DOUT	DR	Input	None	Serial data output
J2.14	RESET	GPIO4	Input	Yes	Reset input (via J7)
J2.15	$\overline{DRDY}$	INT	Output	None	Data ready signal
J2.16	SCL	SCL	I/O	None	I <sup>2</sup> C clock line
J2.17	EXTCLK	TOUT	Input	None	External system clock input
J2.18	DGND	DGND	I/O	Power	Digital ground
J2.19	$\overline{SYNC/PDW}$ $\overline{N}$	GPIO5	Input	Yes	Synchronization and power down control pin (via J6)
J2.20	SDA	SDA	I/O	None	I <sup>2</sup> C data line

### 3.2 GPIO

The ADS1256 has four general-purpose I/O (GPIO) pins. One of these pins can also be configured as a buffered system clock output. This output is typically used to clock additional ADS1255/ADS1256 devices, but can be used for other purposes as well. The GPIO pins for the ADS1256 are shown in [Figure 2](#). These pins (from left to right) are D3 to D0.



**Figure 2. GPIO Pins**

Each pin is connected to the GPIO header through a 100Ω resistor. 100kΩ pull-downs on each pin protect the GPIOs when they are configured as inputs, which is the default setting. The GPIO header, J5, carries the GPIO pins for the ADS1256.

The GPIO header pinout is described in [Table 3](#).

**Table 3. J5: GPIO Header Pins**

Pin Number	Pin Name	Function
1	D0	GPIO or buffered system clock output
2	D1	GPIO
3	D2	GPIO
4	D3	GPIO

## 4 Power Supplies

J5 is the power-supply input connector. It is used as the primary supply source for the entire EVM. [Table 4](#) lists the configuration details for J2.

**Table 4. J5 Configuration: Power-Supply Input**

Pin No.	Pin Name	Function	Required
J5.1	+VA	Positive analog supply, +5V to +18V	No
J5.2	-VA	Negative analog supply, -5V to -18V	No
J5.3	+5VA	Positive analog supply, +5V	Always
J5.4	-5VA	Negative analog supply, -5V	No
J5.5	DGND	Digital ground	Optional connection to AGND through J10
J5.6	AGND	Analog ground	Ground
J5.7	+1.8VD	Positive digital supply, +1.8V	Digital supply; select using J9
J5.8	VD1	Positive digital supply	No
J5.9	+3.3VD	Positive digital supply, +3.3V	Digital supply; select using J10
J5.10	+5VD	Positive digital supply, +5V	No



## 4.1 Power Options

There are six jumpers on the ADS1256EVM, arranged in a single jumper block of seven rows, each of which can be shorted. (In the schematic, J4, J9, and J10 are all combined to make this single block). The pinout of this jumper block is shown in [Figure 3](#).

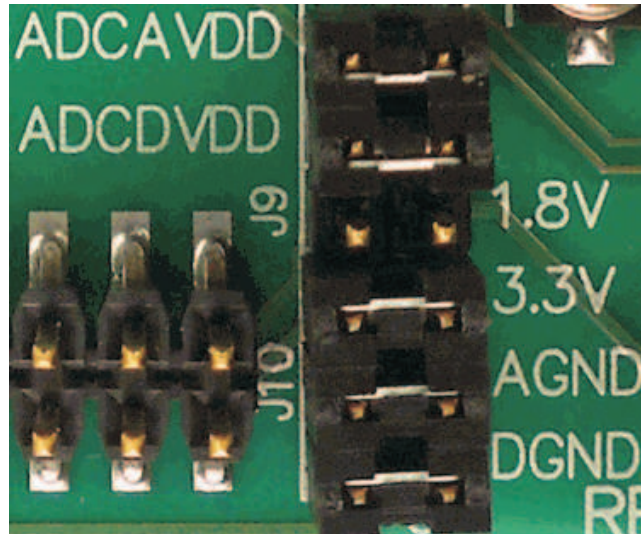

**Figure 3. Jumper Block**

J4 connects AVDD from the +5V from the power-supply header, J3. J4 also connects the DVDD supply to the ADS1256 device. DVDD can be set to 1.8V with J9, or to 3.3V with pins 1 and 2 of J10. Pins 3 and 4, 5 and 6, are used to set the ground of the EVM.

Pinouts and connections can all viewed in the schematic and the layout plots at the end of this user guide.

### 4.1.1 J4 Pins 1-2: ADS1256 Analog Power Supply

This jumper is used to measure the current of the ADS1256 analog power supply. For normal operation, this jumper should be shorted.

### 4.1.2 J4 Pins 3-4: ADS1256 Digital Power Supply

Use this jumper to measure the current of the ADS1256 digital power supply. For normal operation, this jumper should be shorted. The voltage of the digital supply is chosen by the jumper on pins 5-6 (1.8V) or 7-8 (3.3V).

### 4.1.3 J9 Pins 1-2: Select 1.8V Digital Supply Voltage

These pins select 1.8V for the digital supply voltage. If this selection is used, do not populate pins 7-8.

### 4.1.4 J10 Pins 1-2: Select 3.3V Digital Supply Voltage

These pins select 3.3V for the digital supply voltage. If this selection is used, do not populate pins 5-6.

### 4.1.5 J10 Pins 3-4: DGND Select

Shorting this jumper connects the ADS1256EVM ground net to DGND.

#### 4.1.6 J10 Pins 5-6: AGND Select

Shorting this jumper connects the ADS1256EVM ground net to AGND. For normal operation, J4.1-2, J4.3-4, and J4.9-10 must be connected (either directly or through an ammeter); either J4.5-6 or J4.7-8 must be connected, and either (or both) of J4.11-12 and J4.13-14 must be connected, as well. Otherwise, the board will not function. Refer to [Table 5](#) for details.

**Table 5. J4, J9, and J10 Configuration: Power Options**

Row	Name	Function
1-2	ADC AVDD	AVDD supply current measurement point for the ADC. Must be connected for operation.
3-4	ADC AVSS	AVSS supply current measurement point for the ADC. Must be connected for operation.
5-6	1.8V select	When shorted, DVDD is sourced from the 1.8V power-supply input pin. Should not be connected at the same time as 7-8.
7-8	3.3V select	When shorted, DVDD is sourced from the 3.3V power-supply input pin. Should not be connected at the same time as 5-6.
9-10	ADC DVDD	DVDD supply current measurement point for the ADC. Must be connected for operation.
11-12	DGND	Connects DGND to board ground.
13-14	AGND	Connects AGND to board ground.

## 5 Voltage Reference

The ADS1256EVM has several reference options that can be selected by switch S3. First, there are connections to apply an external reference voltage to the analog input header. The user can apply a reference voltage to J1.18 and J1.20 in order to set the reference.

The ADS1256 also has a buffered REF5025 on board. This 2.5V reference can also be selected by switch S3. VRN to VRP can be set from AGND to 2.5V or from 2.5V to AVDD. [Figure 4](#) illustrates how switch S3 appears on the board. A description of switch S3 is provided in [Table 6](#).



**Figure 4. Switch S3**

**Table 6. Reference Input Select Switch**

Board Marking	Switch Position	Input Source	VRP Connection	VRN Connection
EST	Down	External	J1.20	J1.18
OBH	Middle	Onboard, high common-mode	AVDD	+2.5V
OBL	Up	Onboard, low common-mode	+2.5V	AGND

In the EXT position, J1 pins 18 and 20 are connected to the ADS1256 reference input.

In the OBH position, the analog power supply is connected to the positive reference input, and the negative reference input is connected to the output of the onboard reference.

In the OBL position, the onboard reference output is connected to the ADS1256 positive reference input pin, and the negative reference input pin is grounded.

Both OBH and OBL provide a +2.5V reference to the ADS1256. The OBL position corresponds to the standard method to connect a reference to the ADS1256, and should be used for most measurements. The OBH position is useful for testing the reference input common-mode sensitivity, which can be important for ratiometric connections.

## 6 Clock Source

As shown in [Figure 5](#), switch S4 selects which of the two available clock sources on the ADS1256EVM will be provided to the ADS1256. [Table 7](#) summarizes the positions of the switch.

**Figure 5. Switch S4**
**Table 7. System Clock Select Switch**

Board Marking	Switch Position	Clock Source
XTAL	Left	Onboard 7.68MHz crystal
EXT	Right	External (J2 pin 17)

## 7 EVM Operation

This section provides information on the analog input, digital control, and general operating conditions of the ADS1256EVM.

### 7.1 Analog Input

The analog input sources can be applied directly to J1 (top or bottom side). Additionally, switches S1 and S2 must be set to route the input signals from J1. Otherwise, the inputs are used to measure the reference or inputs shorted to the reference. Switches S1 and S2 are shown in [Figure 6](#).

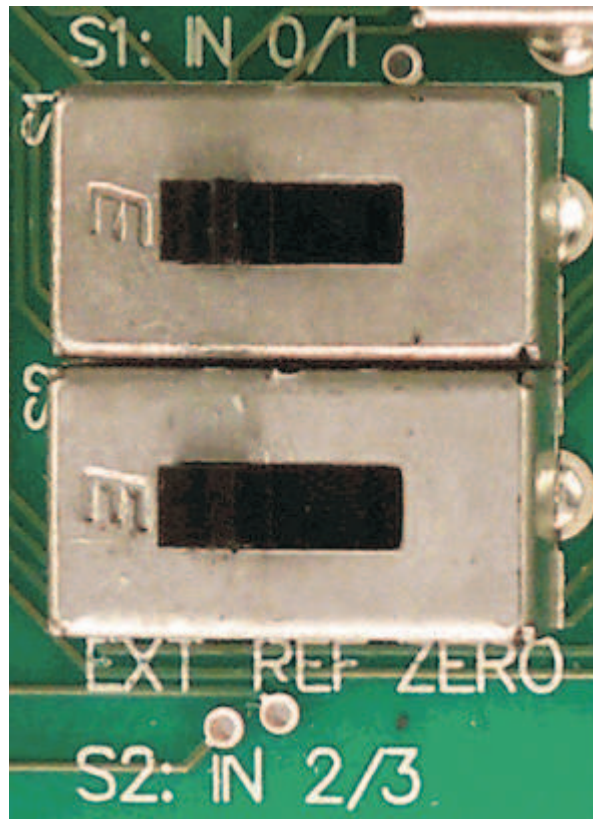

Figure 6. Switches S1 and S2

#### 7.1.1 S1: AIN0-1 Input Select

These switches control which lines are routed to the ADS1256 AIN0-AIN1 inputs. [Table 8](#) shows the positions of these switches.

Table 8. AIN0-1 Input Select Switch (S1)

Board Marking	Switch Position	Input Source	AIN0 Connection	AIN1 Connection
EXT	Left	External	J1.2	J1.1
REF	Middle	Reference voltage	+2.5V	AGND
ZERO	Right	Zero (shorted to reference)	+2.5V	+2.5V

In the EXT position, J1 pins 1 and 2 are connected to the ADS1256 AIN1 and AIN0 pins, respectively. In the REF position, the reference is connected across the ADS1256 AIN0 and AIN1 pins. In the ZERO position, both AIN0 and AIN1 are connected to the reference. This configuration gives a zero-scale reading across AIN0 and AIN1.

The REF and ZERO positions are useful for noise tests.

### 7.1.2 S2: AIN2-3 Input Select

These switches control which lines are routed to the ADS1256 AIN2 through AIN3 inputs. The positions of the switches are described in [Table 9](#).

**Table 9. AIN2-3 Input Select Switch (S2)**

Board Marking	Switch Position	Input Source	AIN0 Connection	AIN1 Connection
EXT	Left	External	J1.4	J1.3
REF	Middle	Reference voltage	+2.5V	AGND
ZERO	Right	Zero (shorted to reference)	+2.5V	+2.5V

In the EXT position, J1 pins 3 and 4 are connected to the ADS1256 AIN3 and AIN2 pins, respectively. In the REF position, the reference is connected across the ADS1256 AIN2 and AIN3 pins. In the ZERO position, both AIN2 and AIN3 are connected to the reference. This configuration gives a zero-scale reading across AIN2 and AIN3.

The REF and ZERO positions are useful for noise tests.

### 7.1.3 Input Filtering Capacitors

The ADS1256EVM has pads for filtering capacitors on every input pair and for the reference input. Each input pair has pads for two common-mode capacitors and one differential capacitor.

The ADS1256 has a flexible input multiplexer, so these capacitors do not always function as common-mode and differential signal filters. For example, when measuring a single-ended input, the common-mode capacitors act to filter the signal.

The ADS1256EVM is shipped with only some of the capacitor pads populated. This configuration allows the board to be immediately used to measure both differential and single-ended inputs. As shipped, inputs AIN0 through AIN7 have 10nF differential mode capacitors installed. A differential 1 $\mu$ F capacitor is connected to the reference near the reference pins.

The input filtering capacitors are in relatively large 1210-size packages, in contrast to most of the other passives on the board. These capacitors were designed to be large so that you can easily remove them or replace them with other values. By exercising appropriate care, you can even solder leaded devices to these large pads.

## 7.2 Digital Control

The digital control signals can be applied directly to J6 (top or bottom side). The modular ADS1256EVM can also be connected directly to a DSP or microcontroller interface board, such as the [5-6K Interface](#) or [HPA-MCU Interface](#) boards available from Texas Instruments, or the MMB0 if purchased as part of the ADS1256EVM-PDK. For a list of compatible interface and/or accessory boards for the EVM or the ADS1256, see the relevant product folder on the [TI web site](#).

## 7.3 ADS1256EVM-PDK Power Supply

The analog portion of the ADS1256EVM can either be powered by a 5V source generated via ac adapter, or by applying the +5VA to the connector on the MMB0 board. The MMB0 board will provide the digital 5V and 3.3V to the ADS1256EVM. To provide +5VA to the ADS1256EVM from the MMB0 board, make sure the jumper at J13 (on the MMB0) is closed from +5V to +5VA.

### 7.4 Default Jumper Settings and Switch Positions

Figure 7 shows the jumpers and switches found on the EVM and the respective factory default conditions for each.

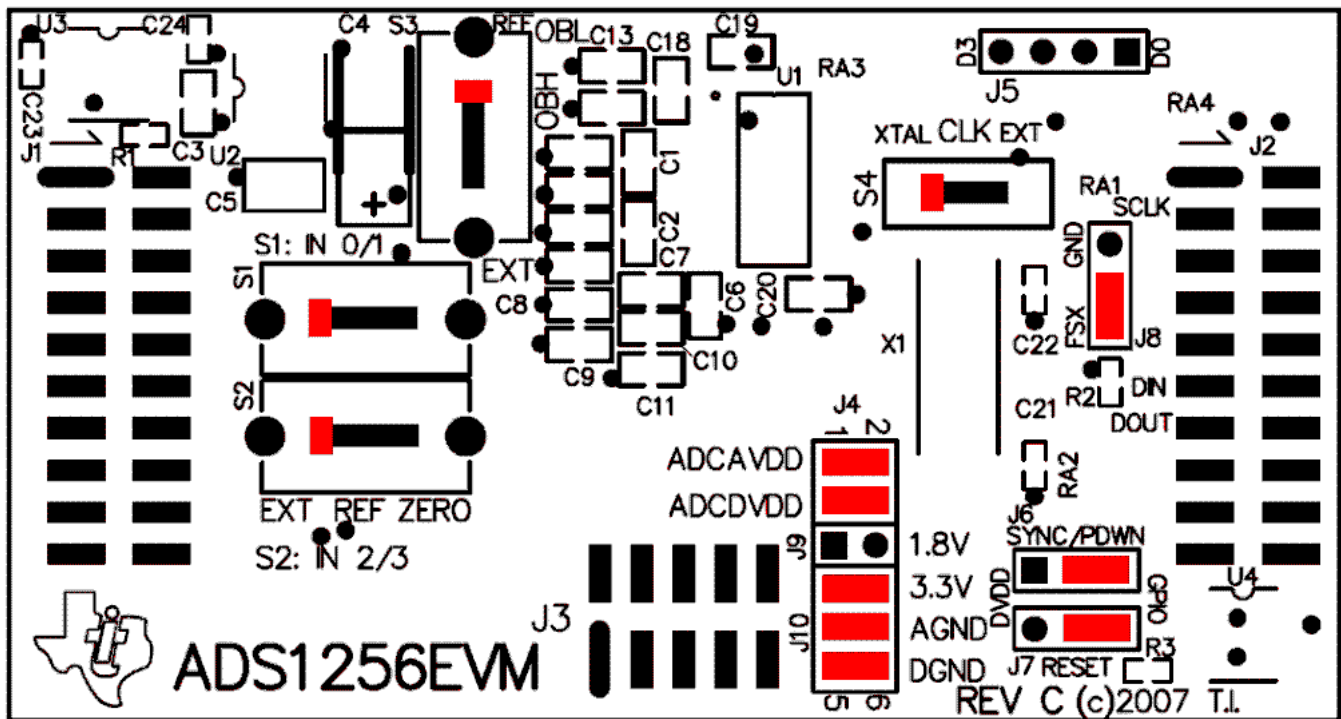

Figure 7. ADS1256EVM Default Jumper and Switch Locations

The jumpers on J4 provide a convenient way to measure the current for any of the power-supply currents AVDD (analog +V power), DVDD (digital power), AVSS (analog -V power), or the ground connections VGND and DGND. Simply remove the jumper for the appropriate power supply and use a current meter between the jumper pins. The supply voltage for the digital supply (DVDD) can also be selected to be either 1.8V or 3.3V; refer to Table 5.

Table 10 and Table 11 provide a list of jumpers and switches found on the EVM and the respective factory default conditions for each.

Table 10. Default Jumper Positions

Jumper	Default Jumpers	Jumper Description
J4	1-2 and 3-4	AVDD and DVDD current measurement connection
J6	2-3	SYNC/PDWN header connection
J7	1-2	RESET header connection
J8	1-2	CS header connection
J9	none	+1.8VD connection
J10	1-2, 3-4, and 4-5	+3.3VD, AGND, and DGND Connection



**Table 11. Default Switch Positions**

Switch	Default Position	Switch Description
S1	Left	AIN0-1 Input Select Switch
S2	Left	AIN2-3 Input Select Switch
S3	Up	Reference Input Select
S4	Left	System Clock Select Switch

## 8 ADS1256EVM-PDK Kit Operation

This section provides information on using the ADS1256EVM-PDK, including setup, program installation, and program usage. To prepare to evaluate the ADS1256 with the ADS1256EVM-PDK, complete the following steps:

- Step 1. Install the ADCPro software (if not already installed).
- Step 2. Install the ADS1256EVM-PDK EVM plug-in software.
- Step 3. Set up the ADS1256EVM-PDK.
- Step 4. Connect a proper power supply or ac adapter.
- Step 5. Complete the NI-VISA™ USB driver installation process.
- Step 6. Run the ADCPro software.
- Step 7. Complete the Microsoft Windows USB driver installation process.

Each task is described in the subsequent sections of this document.

### 8.1 Installing the ADCPro Software

#### CAUTION

Do not connect the ADS1256EVM-PDK before installing the software. Failure to observe this may cause Microsoft Windows to not recognize the ADS1256EVM-PDK.

The latest software is available from Texas Instruments' website at <http://www.ti.com/tool/ADS1256EVM-PDK>. Download the ADCPro Installer from the [ADCPro product information page](#) on the TI website. Refer to the [ADCPro User Guide](#) for instructions on installing and using ADCPro.

To install the ADS1256EVM-PDK plug-in, download and run the file: **ADS1256evm-pdk-plug-in-1.0.0.exe** from the [ADS1256EVM-PDK product folder](#) (1.0.0 is the version number, and increments with software version releases). Double-click the file to run it; then follow the instructions shown.

Installation for the ADS1256EVM plug-in should be relatively straightforward. The plug-in comes as an executable file. Once started, the program leads the user through the screens shown in [Figure 8](#) through [Figure 11](#).

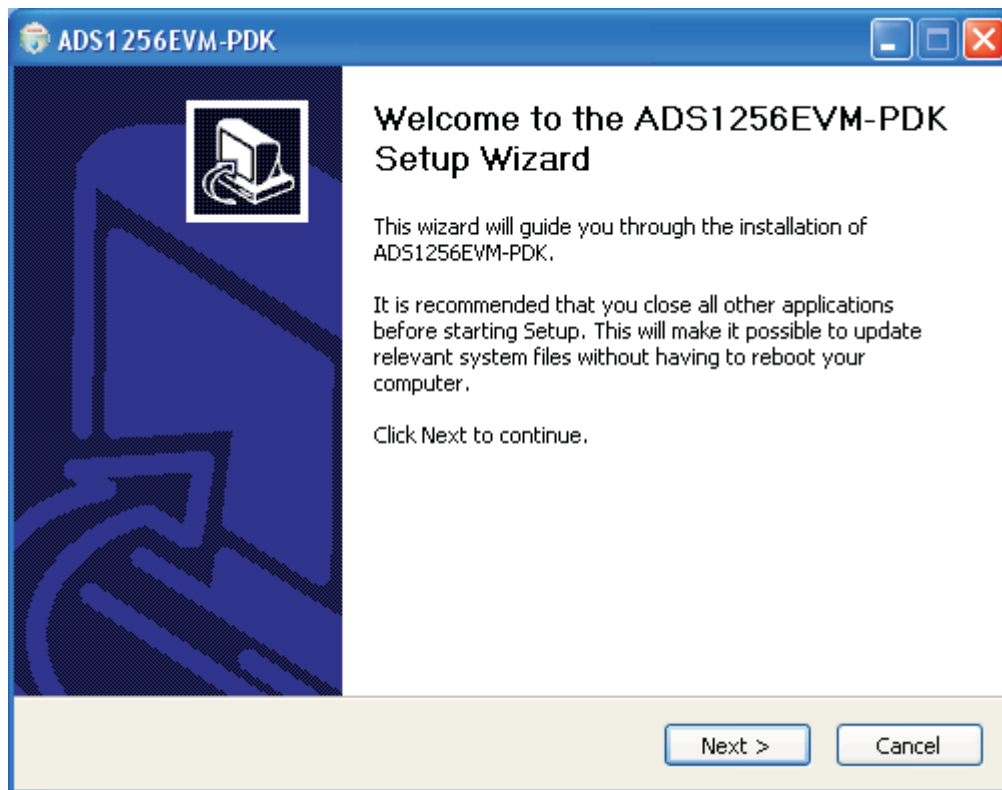

**Figure 8. ADS1256EVM-PDK Setup Wizard**

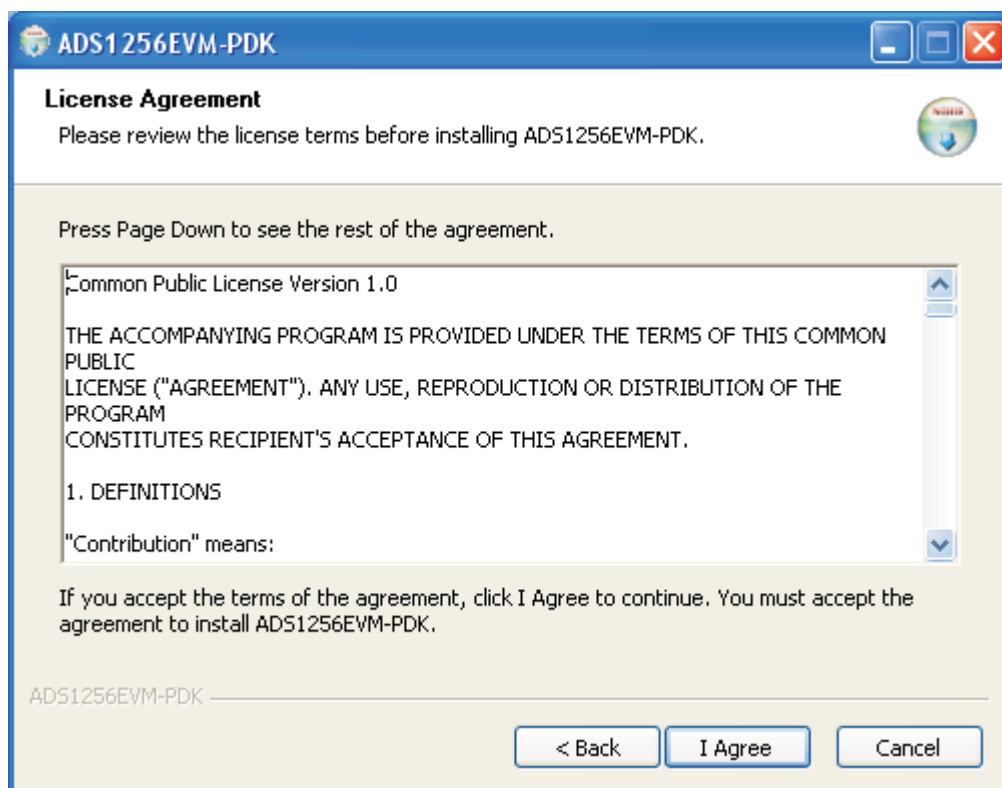

**Figure 9. ADS1256EVM-PDK License Agreement**

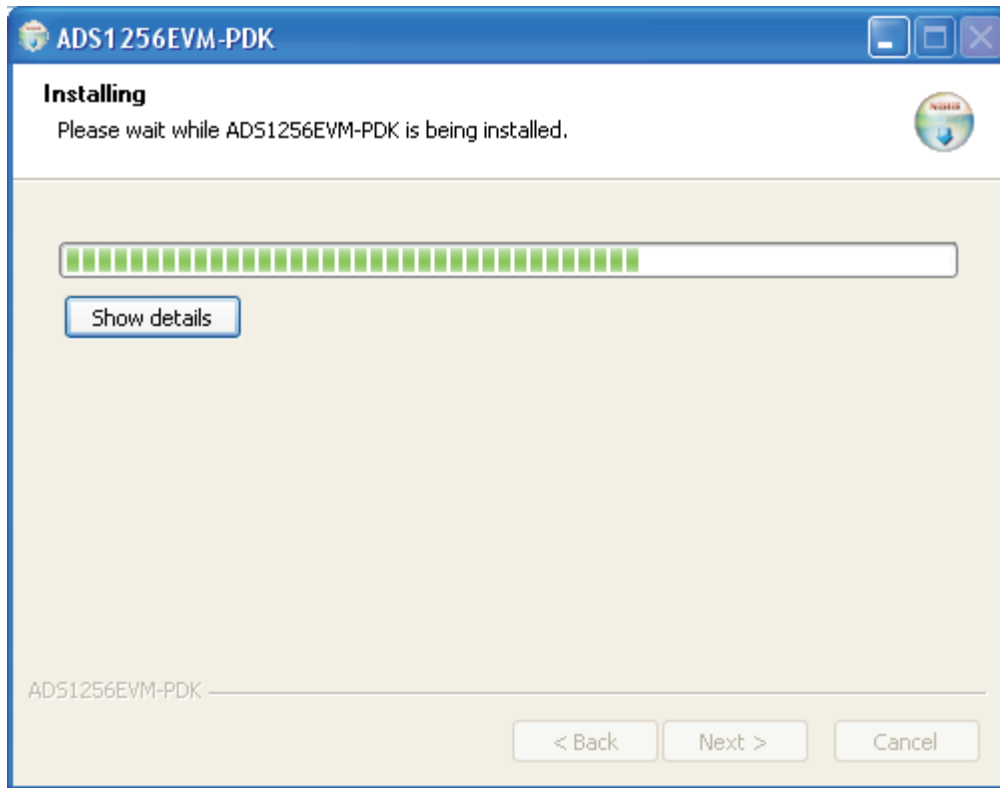

Figure 10. ADS1256EVM-PDK Installation in Progress

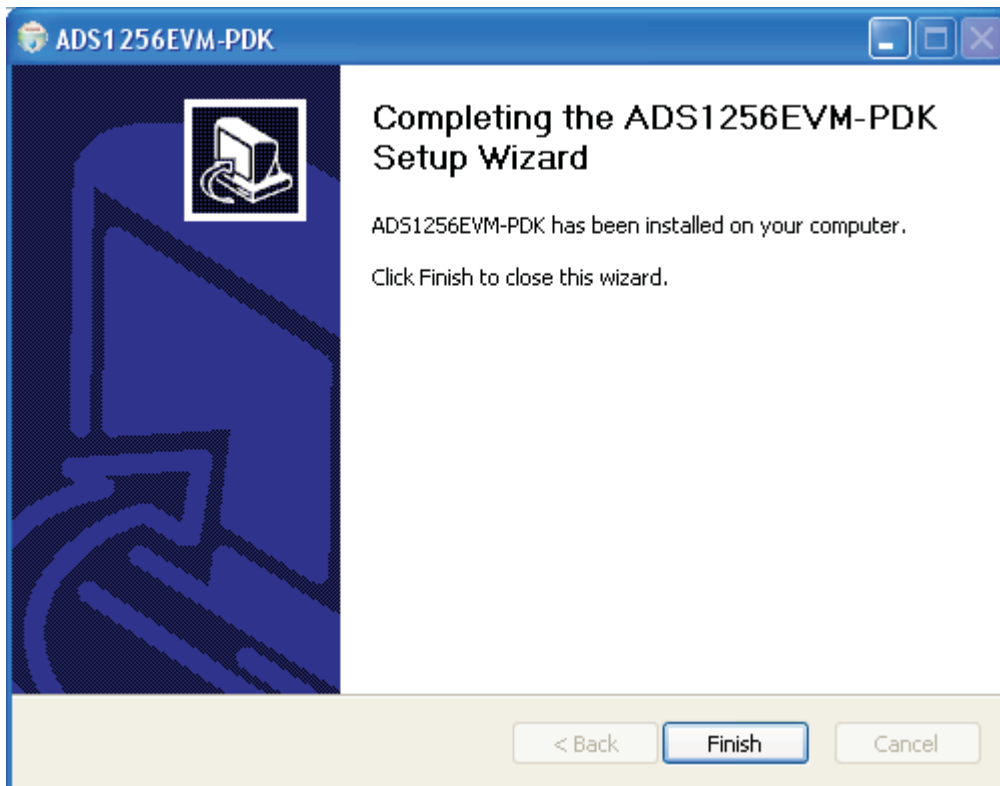

Figure 11. ADS1256EVM-PDK Installation Complete

The software should now be installed, but the USB drivers may not yet have been loaded by the PC operating system. This step completes when the ADCPro software is executed; see [Section 8.4, Running the Software and Completing Driver Installation](#).

## 8.2 Setting Up the ADS1256EVM-PDK

The ADS1256EVM-PDK contains both the ADS1256EVM and the MMB0 motherboard; however, these devices are shipped unconnected. Follow these steps to set up the ADS1256EVM-PDK:

- Step 1. Unpack the ADS1256EVM-PDK kit.
- Step 2. Set the jumpers and switches on the MMB0 as shown in [Figure 12](#).
  - Connect +5V and +5VA on jumper block J13 (if +5V is supplied from J14 +5VA).
  - Leave +5V and +VA disconnected on jumper block J13.
  - If the PDK will be powered from an ac adapter, and used in unipolar mode, connect J12. If the PDK will be powered through the terminal block or will be used in bipolar mode, disconnect J12. (See [Section 8.3](#) for details on connecting the power supply.)

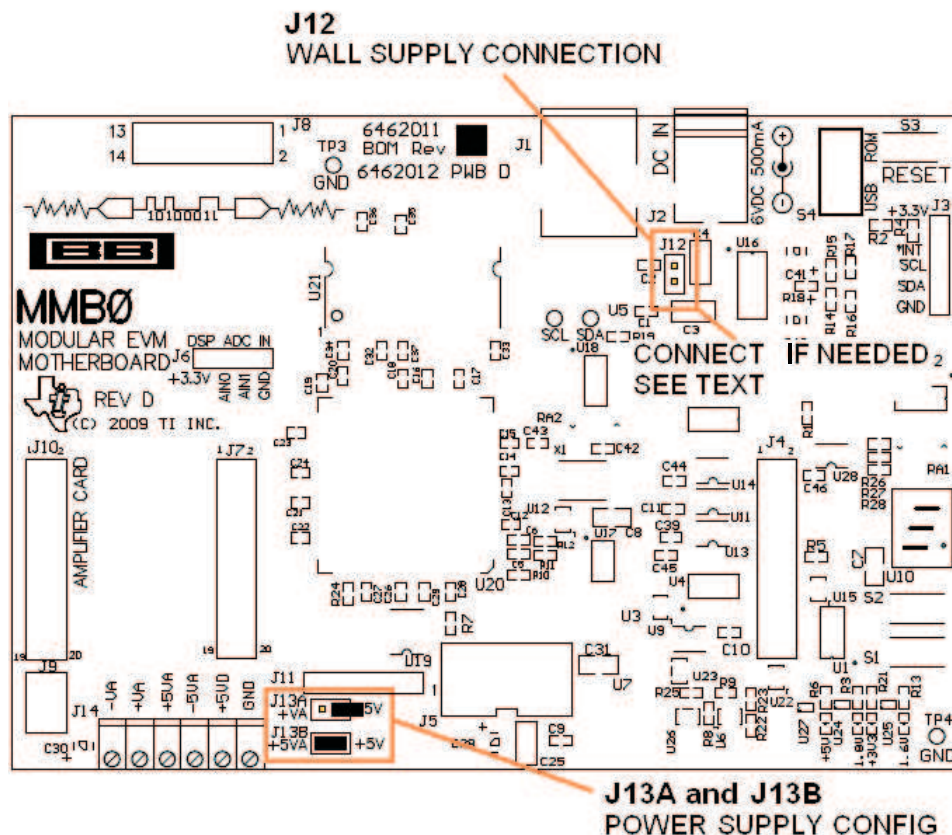

**Figure 12. MMB0 Initial Configuration**

Step 3. Plug the ADS1256EVM into the MMB0.

**CAUTION**

Do not misalign the pins when plugging the ADS1256EVM into the MMB0. Check the pin alignment carefully before applying power to the PDK.

Step 4. Set the jumpers and switches on the ADS1256EVM as shown in [Figure 13](#) (note that these settings are the factory-configured settings for the EVM):

- Set jumper block J4 as shown in [Figure 7](#).
- Set the reference source select switches S1 and S2 to the center position.
- Set up jumper block J3 as shown; refer to [Figure 7](#).

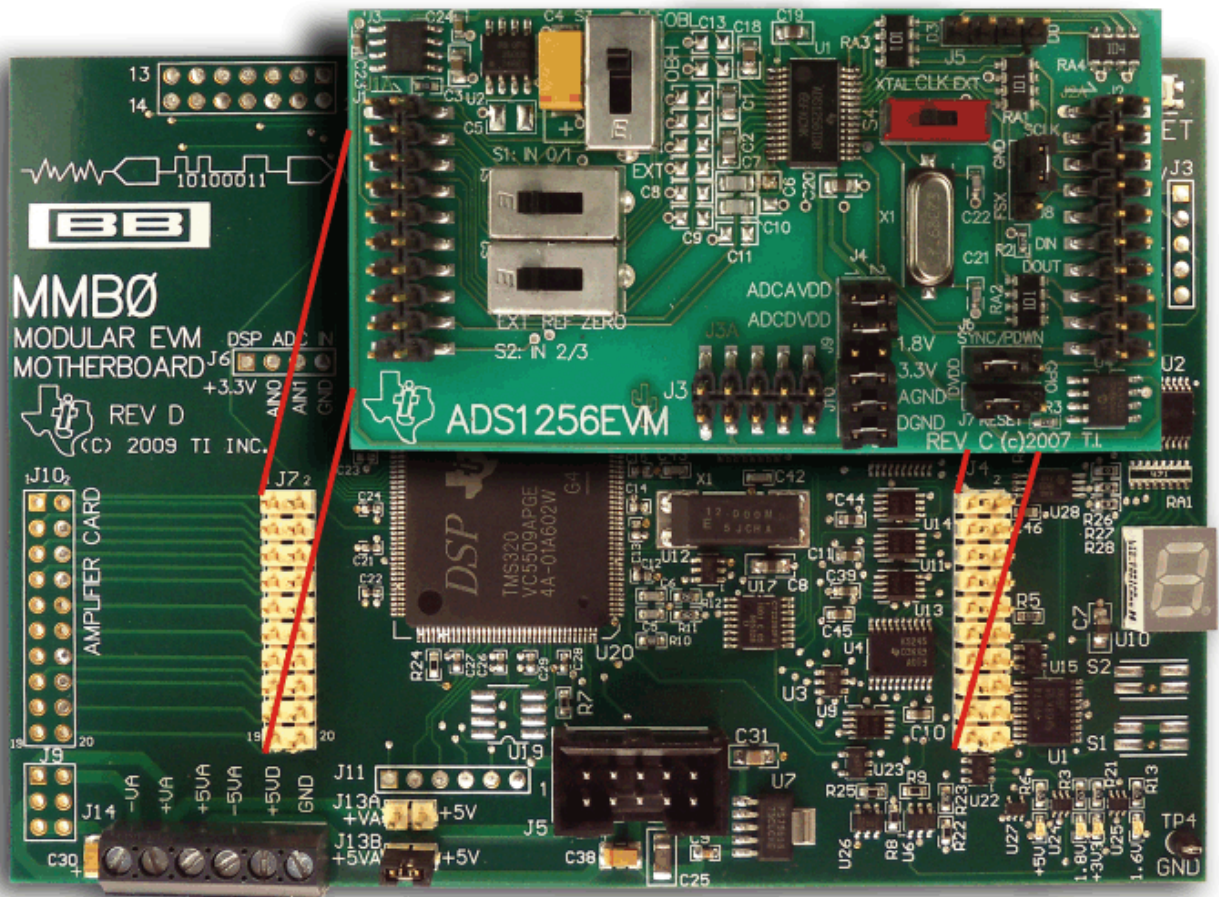

Figure 13. Connecting the ADS1256EVM to the MMB0



### 8.2.1 About the MMB0

The MMB0 is a Modular EVM System motherboard. It is designed around the [TMS320VC5507](#), a DSP from Texas Instruments that has an onboard USB interface. The MMB0 also has 16MB of SDRAM installed.

The MMB0 is not sold as a DSP development board, and it is not available separately. TI cannot offer support for the MMB0 except as part of an EVM kit. For schematics or other information about the MMB0, contact Texas Instruments.

### 8.3 Connecting the Power Supply

The ADS1256EVM-PDK can be operated with a unipolar +5V supply or a bipolar  $\pm 5V$  supply.

If the ADS1256EVM-PDK is to be operated in unipolar mode only, either an ac adapter or a lab power supply can be used. If the ADS1256EVM-PDK is to be operated in bipolar mode, a  $\pm 5V$  power supply must be connected; an ac adapter cannot be used.

When the MMB0 DSP is powered properly, LED D2 glows green. The green light indicates that the 3.3V supply for the MMB0 is operating properly. (It does **not** indicate that the EVM power supplies are operating properly.)

#### 8.3.1 Connecting an AC Adapter

An ac adapter can be connected to barrel jack J2 on the MMB0. J2 is located next to the USB connector. Refer to the [External Wall-Adapter Power-Supply Requirements](#) section.

When an ac adapter is used, the ADS1256EVM cannot be used in bipolar mode.

Jumper J12 on the MMB0 connects a wall-mounted power supply to the board. To use the wall-mount supply, J12 must be shorted, refer to [Figure 14](#).

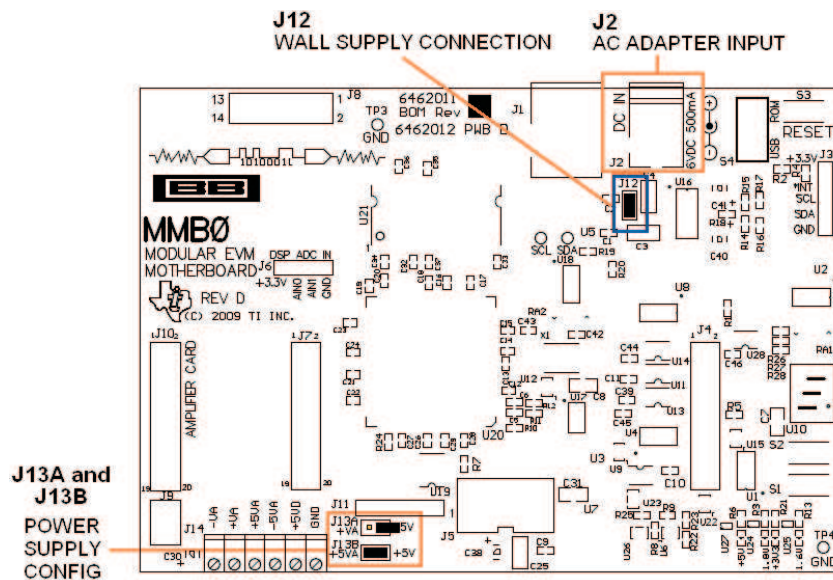

Figure 14. MMB0 Powered From AC Adapter



### 8.3.1.1 External Wall-Adapter Power-Supply Requirements

The external wall-adapter power-supply requirements are as follows:

- Output voltage: 6 VDC to 9 VDC
- Maximum output current:  $\geq 500$  mA
- Output connector: barrel plug (positive center), 2.0-mm I.D.  $\times$  5.5-mm O.D. (9-mm insertion depth)

**NOTE:** Use an external power supply that complies with applicable regional safety standards; for example, UL, CSA, VDE, CCC, PSE, and so forth.

### 8.3.2 Connecting a Laboratory Power Supply

A laboratory power supply can be connected through terminal block J14 on the MMB0, as shown in Figure 15. Both unipolar and bipolar configurations are supported.

To use a unipolar lab power supply configuration:

- Disconnect J12 on the MMB0.
- Connect a +5V dc supply to the +5VD terminal on J14.
- Connect ground of the dc supply to the GND terminal on J14.

For bipolar mode, also connect a -5V dc supply to the -5VA terminal on J14. It is not necessary to connect a +5V dc supply voltage to the +5VA terminal on J14 if the +5V/+5VA position on J13 is shorted.

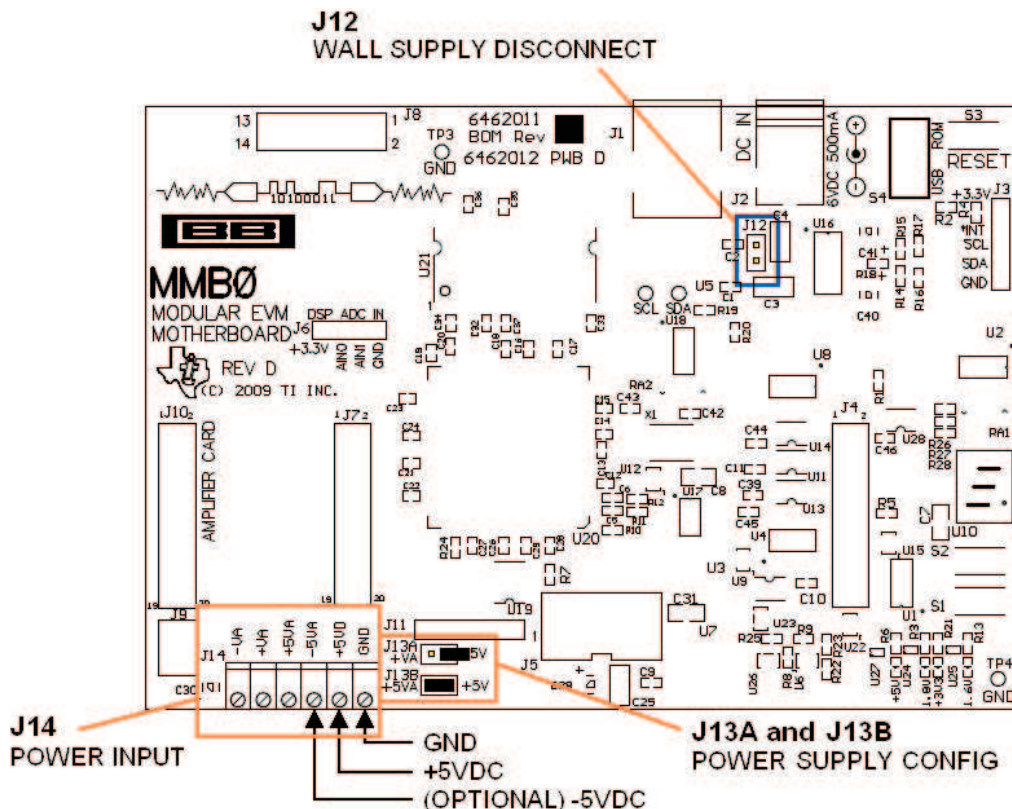

Figure 15. MMB0 Configured for Lab Power Supply

## 8.4 Running the Software and Completing Driver Installation

**NOTE:** The software is continually under development. These instructions and screen images are current at the time of this writing, but may not exactly match future releases.

The program for evaluating the ADS1256EVM-PDK is called *ADCPro*. This program uses plug-ins to communicate with the EVM. The ADS1256EVM-PDK plug-in is included in the ADS1256EVM-PDK package.

The program currently runs only on Microsoft Windows platforms of Windows XP; Windows Vista and Windows 7 are **NOT** supported.

If this is the first time installing ADCPro and plug-ins, follow these procedures to run ADCPro and complete the necessary driver installation. Make sure the ADCPro software and device plug-in software are installed from the CD-ROM as described in [Installing the ADCPro Software](#).

### 8.4.1 NI-VISA USB Device Driver Installation

1. After the ADCPro software is installed, apply power to the PDK and connect the board to an available PC USB port.
2. The computer should recognize new hardware and begin installing the drivers for the hardware. [Figure 16](#) through [Figure 19](#) are provided for reference to show the installation steps.
  - For the first screen ([Figure 16](#)), it is not necessary to search for the software; it has already been installed to your PC.
  - For the remaining steps, accept the default settings.



Figure 16. NI-VISA Driver Installation Wizard, Screen 1

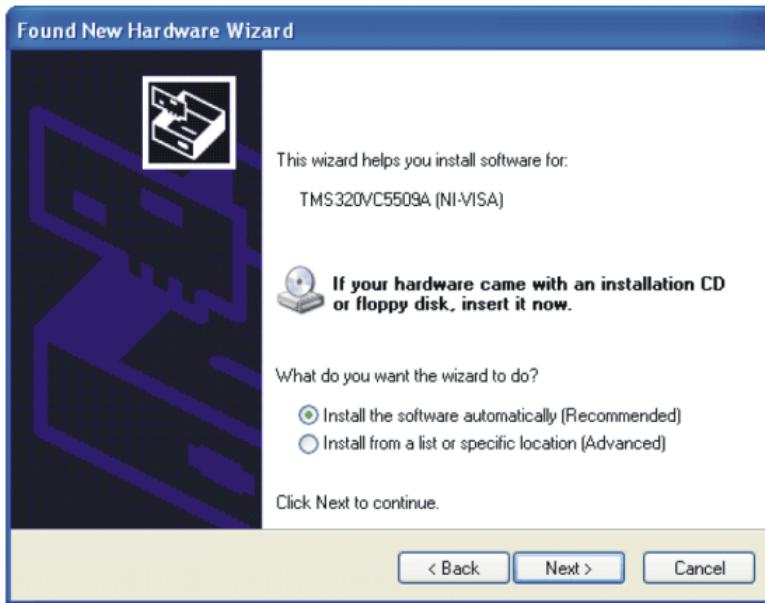

Figure 17. NI-VISA Driver Installation Wizard, Screen 2

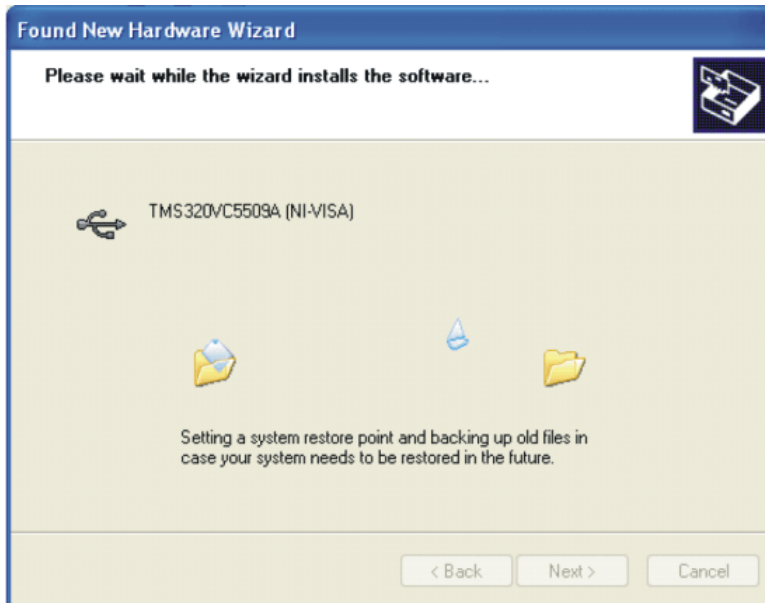
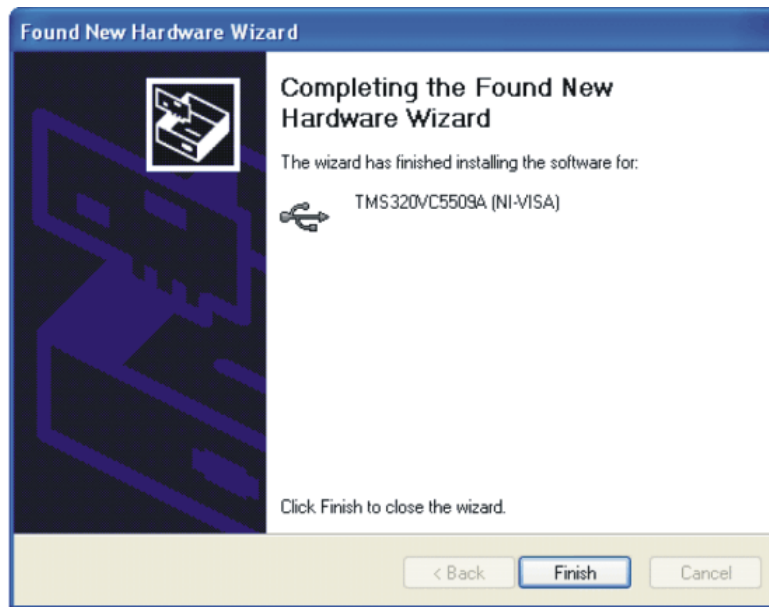

Figure 18. NI-VISA Driver Installation Wizard, Screen 3



**Figure 19. NI-VISA Driver Installation Wizard, Screen 4**

This should complete the installation of the NI-VISA drivers. You can verify proper installation by opening the Device Manager and locating the drivers as shown in [Figure 20](#).



**Figure 20. NI-VISA Driver Verification Using Device Manager**

### 8.4.2 USBStyx Driver Installation

1. Start the software by selecting *ADCPro* from the Windows Start menu. The screen shown in [Figure 21](#) appears.

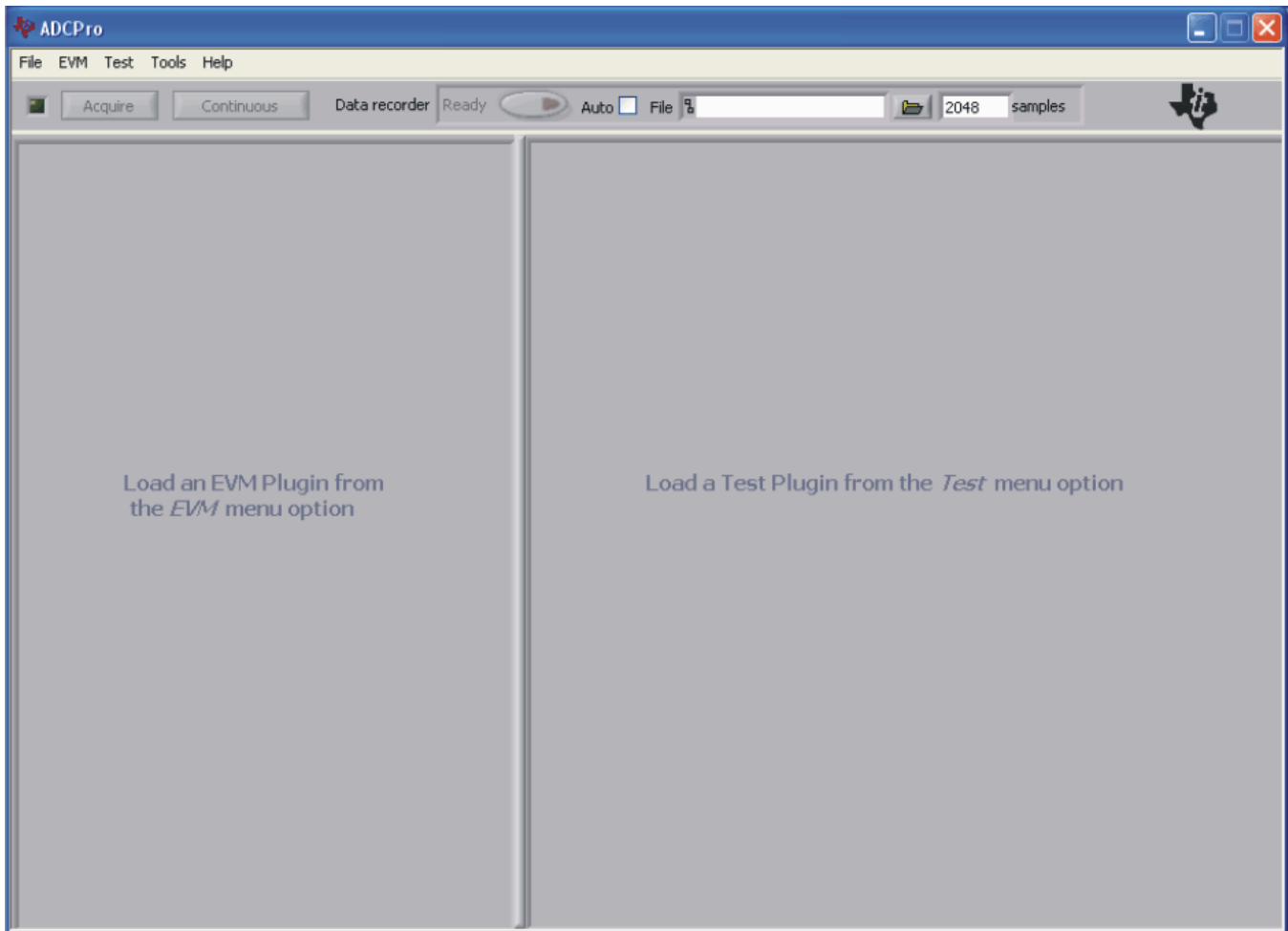

**Figure 21. ADCPro Software Start-up Display Window**

2. Select *ADS1256EVM* from the EVM drop-down menu. The ADS1256EVM-PDK plug-in appears in the left pane, as [Figure 22](#) shows.

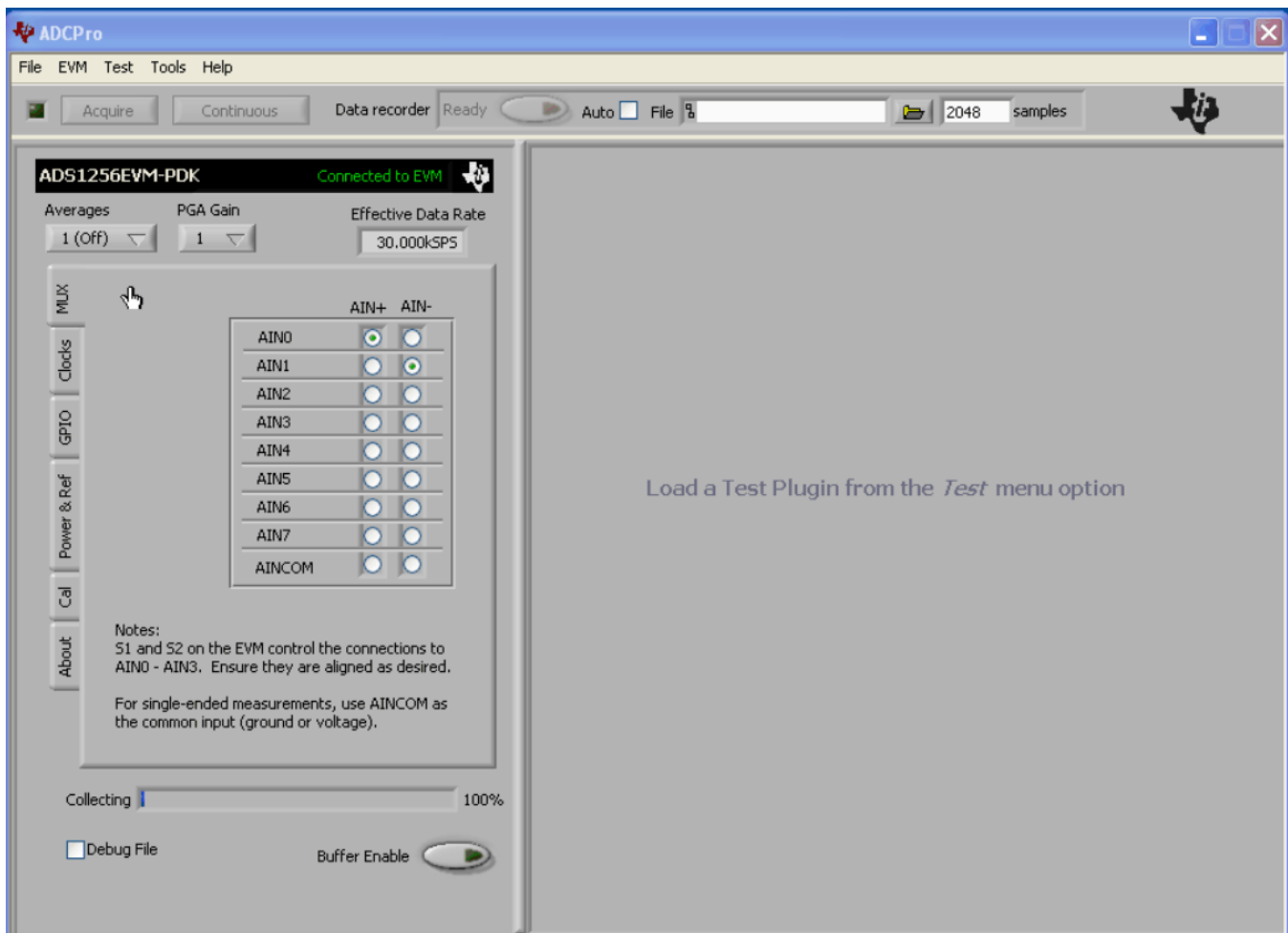

**Figure 22. ADS1256EVM-PDK Plug-In Display Window**

3. The ADS1256EVM-PDK plug-in window has a status area at the top of the screen. When the plug-in is first loaded, the plug-in searches for the board. You will see a series of messages in the status area indicating this action.
4. If you have not yet loaded the operating system drivers, Windows will display the Windows *Install New Driver Wizard* sequence (illustrated in [Figure 23](#) through [Figure 27](#)). Accept the default settings.

---

**NOTE:** During the driver installation, a message may appear indicating the firmware load has TIMED OUT. Click OK and continue driver installation. The plug-in will attempt to download the firmware again once the driver installation completes.

---



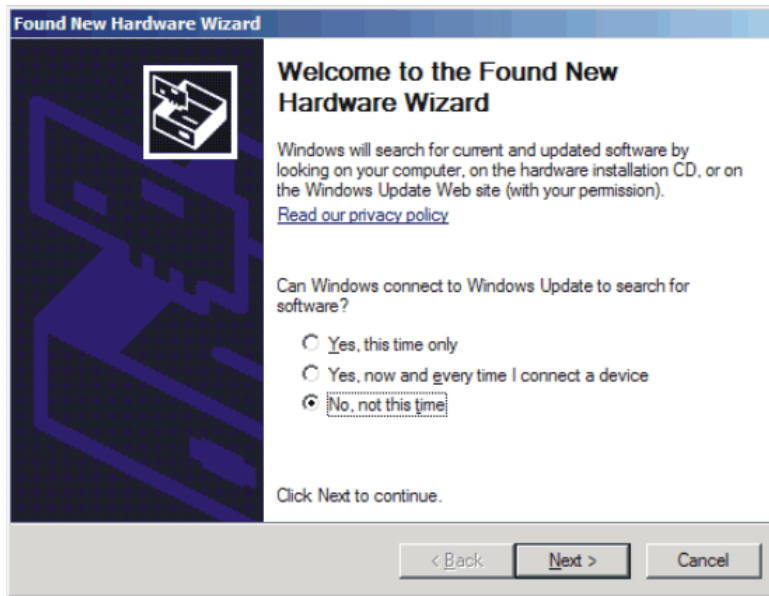

Figure 23. Install New Driver Wizard Screen 1

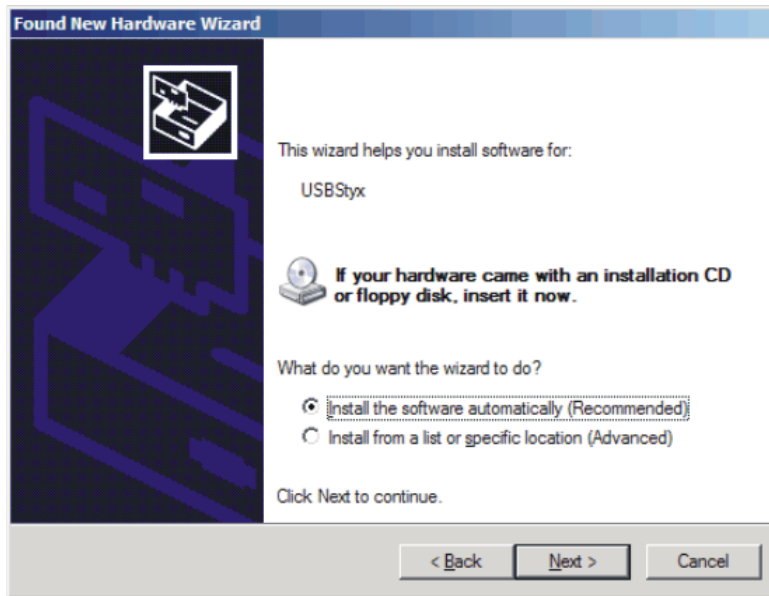
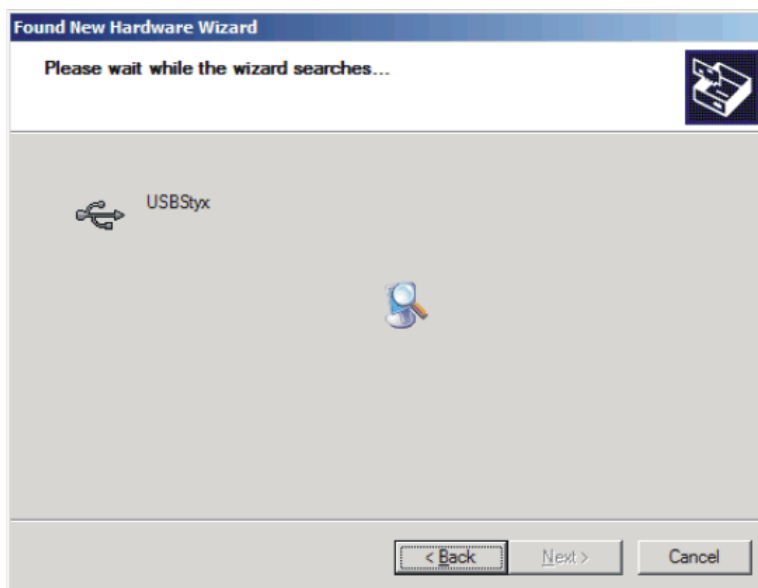
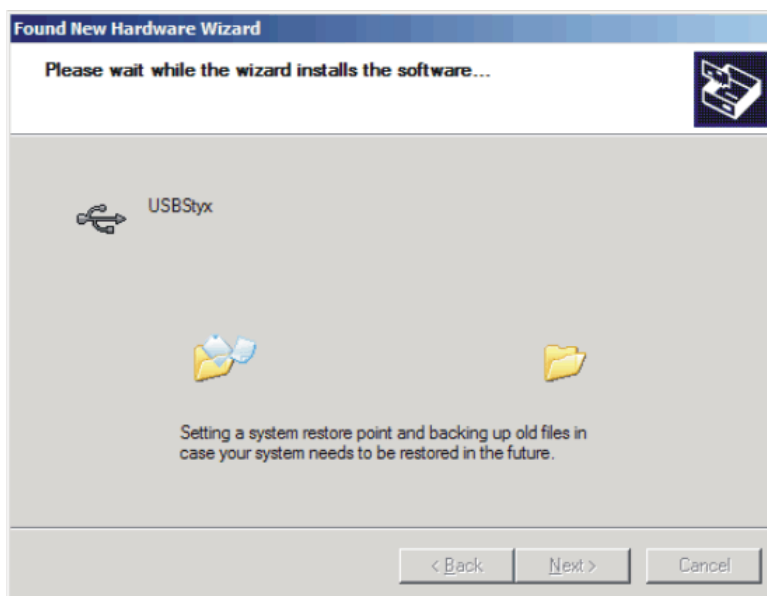

Figure 24. Install New Driver Wizard Screen 2



**Figure 25. Install New Driver Wizard Screen 3**



**Figure 26. Install New Driver Wizard Screen 4**

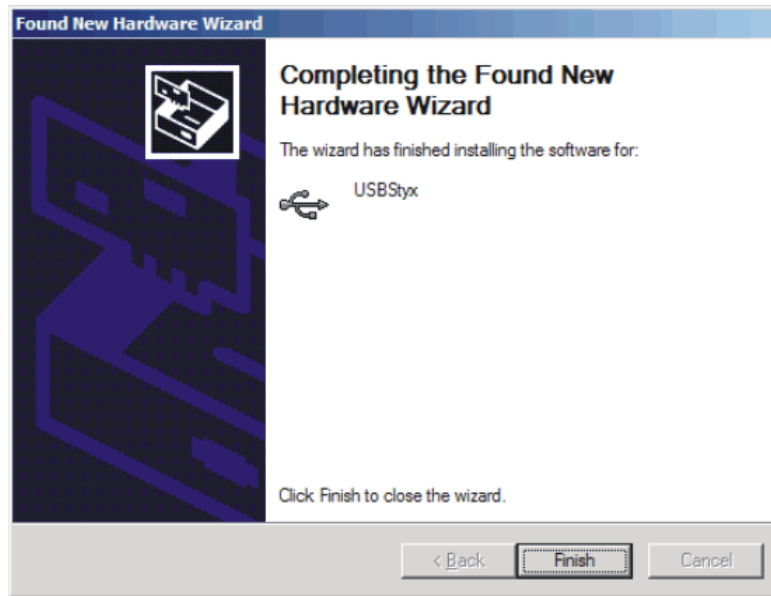

**Figure 27. Install New Driver Wizard Screen 5**

5. Once Windows finishes installing the software driver, the plug-in downloads the firmware to the MMB0. The status area will display *Connected to EVM* when the device is connected and ready to use. If the firmware does not load properly, you can try resetting the MMB0 by pressing *Reset* and then reloading the plug-in.

Verify the proper installation of the USBStyx driver using the Device Manager. Note that the first driver item, NI-VISA USB Devices, disappears and a new item, LibUSB-Win32 Devices appears, as [Figure 28](#) shows.

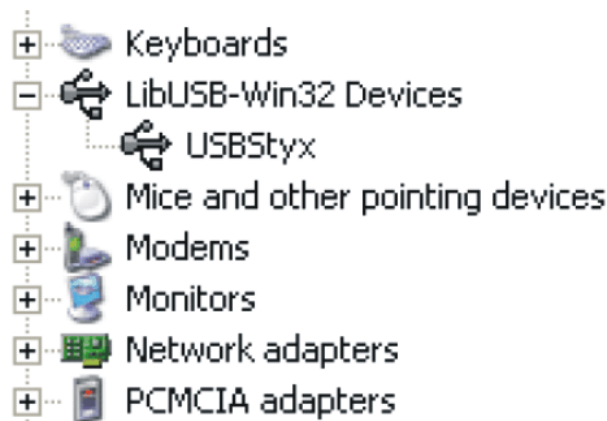

**Figure 28. USBStyx Driver Verification Using Device Manager**

The driver installation wizard sequence should not appear again, unless you connect the board to a different USB port

## 9 Evaluating Performance with the ADCPro Software

The evaluation software is based on ADCPro, a program that operates using a variety of plug-ins. (The ADS1256EVM plug-in is installed as described in the installation section, [Section 8](#).)

To use ADCPro, load an EVM plug-in and a test plug-in. To load an EVM plug-in, select it from the *EVM* menu. To load a test plug-in, select it from the *Test* menu. To unload a plug-in, select the *Unload* option from the corresponding menu.

Only one of each kind of plug-in can be loaded at a time. If you select a different plug-in, the previous plug-in is unloaded.

### 9.1 Using the ADS1256EVM-PDK Plug-in

The ADS1256EVM-PDK plug-in for ADCPro provides complete control over all settings of the ADS1256. It consists of a tabbed interface (see [Figure 22](#)), with different functions available on different tabs. These controls are described in this section.

You can adjust the ADS1256EVM settings when you are not acquiring data. During acquisition, all controls are disabled and settings may not be changed. When you change a setting on the ADS1256EVM plug-in, the setting is immediately updated on the board.

If you unload and reload the plug-in, the software attempts to load settings from the board.

Settings on the ADS1256EVM correspond to settings described in the ADS1256 product data sheet; see the [ADS1256 data sheet](#) (available for download at [www.ti.com](http://www.ti.com)) for details.

In the upper left corner, the **Averages** control sets the ADS1256 averaging mode. This control may be set to 1, 4, 16, or 64. Note that this is a setting for the ADS1256 device itself; no software averaging is done in the ADS1256EVM-PDK plug-in.

The **PGA** pull-down menu controls the PGA gain in the ADS1256.

Because the effective data rate of the ADS1256 depends upon the settings of the multiplexer mode, clocks, switch time delay, chopping, and averages, the **Effective Data Rate** indicator in the upper right corner of the plug-in interface is always visible and updates whenever a setting that affects the data rate changes.

The previous controls are all found at the top of the ADS1256EVM plug-in and shown in [Figure 29](#).

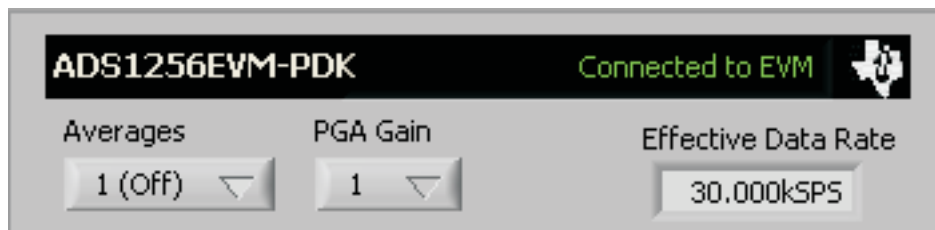

**Figure 29. ADS1256EVM-PDK Plug-In Averages, PGA Gain, and Effective Data Rate Controls**

### 9.1.1 MUX Tab

The first tab of the ADS1256EVM plug-in is the MUX tab. In the tab, two columns of push buttons are used to select the positive and negative inputs for ADS1256. This selection, combined with switches S1 and S2, selects the measurement for the inputs applied to the analog interface J1. The MUX tab is shown in [Figure 30](#).

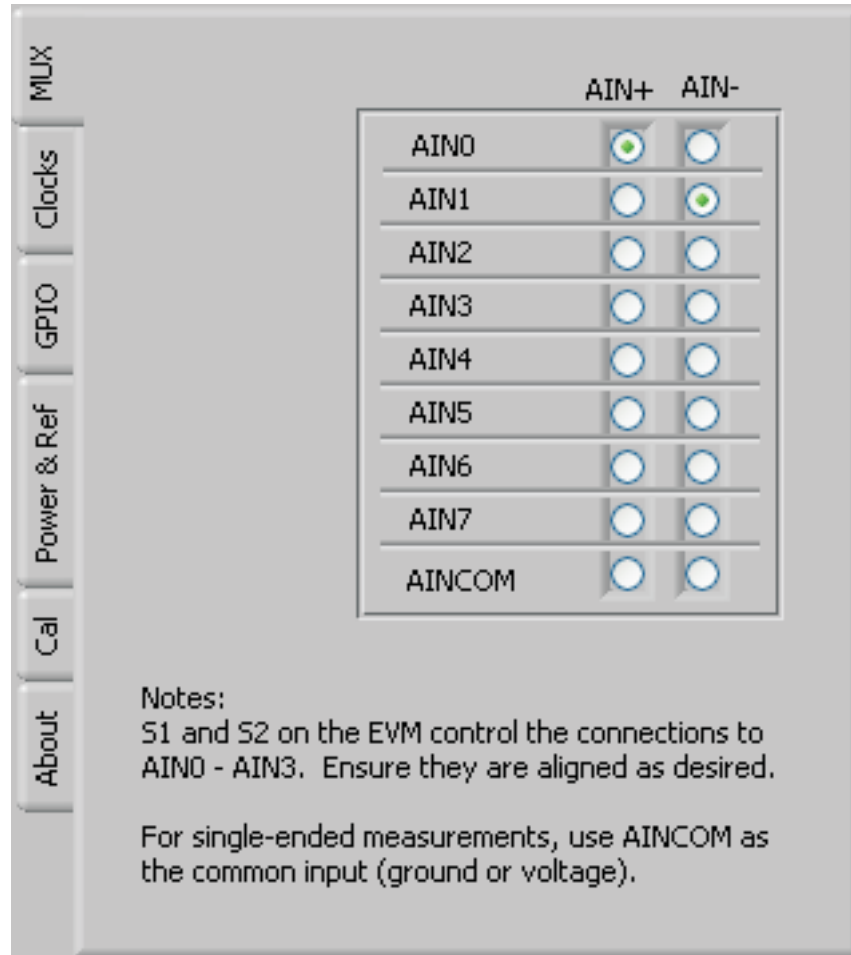
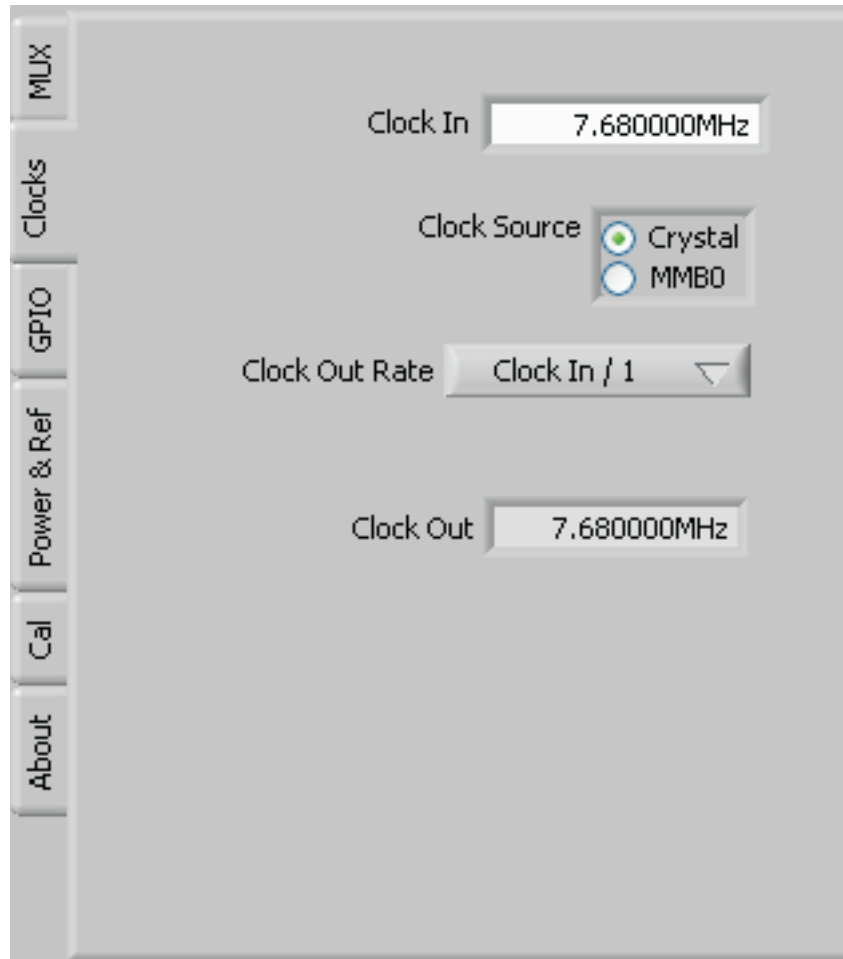

Figure 30. MUX Tab

### 9.1.2 Clocks Tab

The next tab is the Clocks tab, as shown in [Figure 31](#). This tab controls the master clock of the ADS1256EVM. Enter the master clock frequency in the *Clock In* window. The clock source can be selected from between the EVM onboard crystal and the MMB0. The DO/CLKOUT rate can be set by the *Clock Out Rate* pull-down menu. There are options to set CLKOUT to  $f_{CLKIN}$ ,  $f_{CLKIN}/2$ ,  $f_{CLKIN}/4$ , or to turn it off.



**Figure 31. Clocks Tab**



### 9.1.3 GPIO Tab

The GPIO tab is used to control the GPIO pins (D0 through D3) on the ADS1256. Four switches are used to select the GPIO mode (input or output). If the pin is selected as an output, a push button is used to set the output to be either high or low. If the pin is selected as an input, the **Read Inputs** button read the inputs and an indicator light shows if the input is high or low. [Figure 32](#) illustrates the GPIO tab.

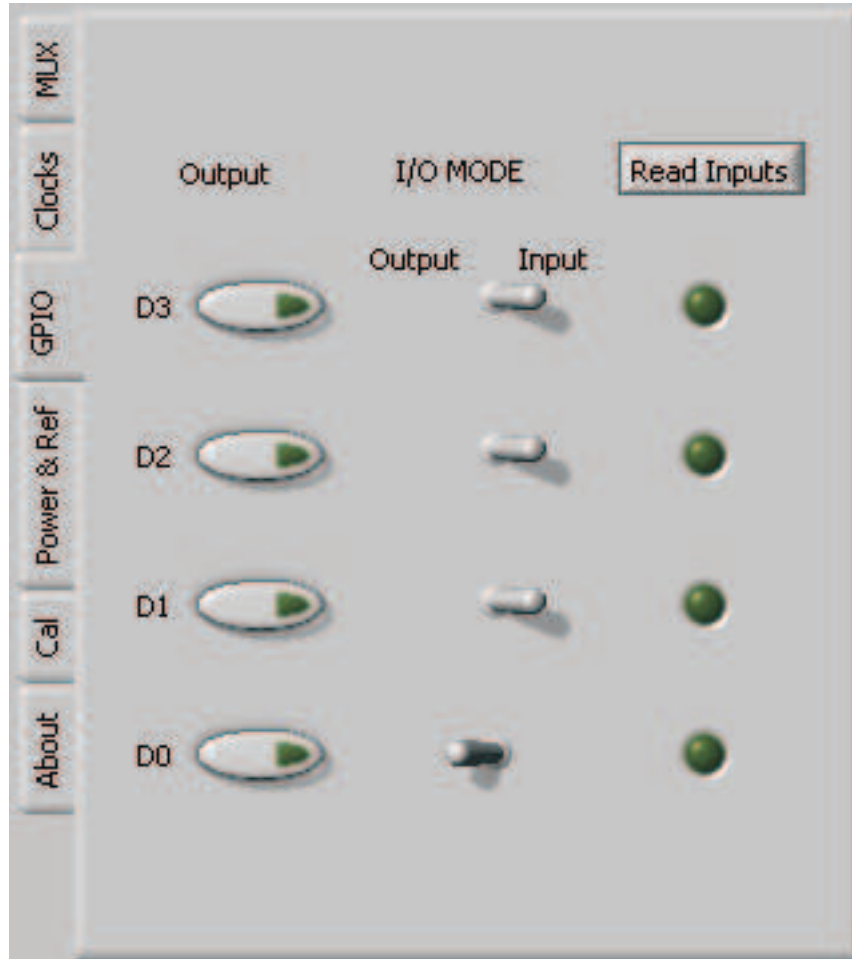

Figure 32. GPIO Tab

### 9.1.4 Power and Reference Tab

The Power & Ref tab selects the reference input, the sensor detect magnitude, and the standby condition. The *VREF Source* window has three pushbuttons that select the reference source and should correspond with the reference setting for switch S3. OBL sets the reference input from AGND to VREF, while OBH sets the reference input from VREF to AVDD. External sets the input from VREF– to VREF+ on the analog input header. If the user applies an external reference, the *Vref* window can be set to calculate the voltage when using the Multichannel Scope test plug-in.

The ADS1256 has sensor detect current sources that can be used to detect a burned out sensor. These current sources are applied to the inputs internal to the ADC. The sensor detect current sources can be set to 0.5mA, 2mA, 10mA, or turned off through using a series of pushbuttons.

To reduce the operating current when the device is not in use, the ADS1256 can be put into standby mode with a pushbutton labeled **Standby**. Pressing the **Wakeup** button releases the ADS1256 from this mode.

The Power & Ref tab is illustrated in [Figure 33](#).

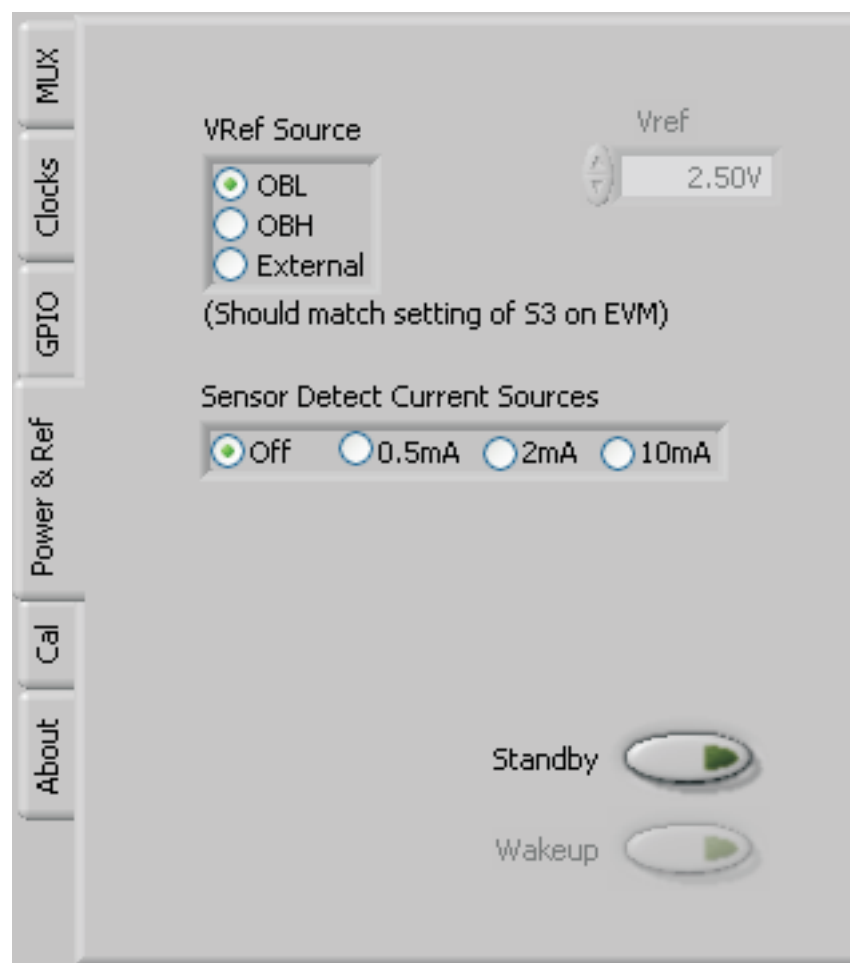

**Figure 33. Power & Ref Tab**

### 9.1.5 Calibration Tab

The Cal tab (as Figure 34 illustrates) controls the calibration of the offset and gain error of the ADS1256. Pressing a pushbutton at the top of the tab runs a self-calibration of the device. Four buttons allow four other calibration options: Self Offset Calibration, System Offset Calibration, Self Gain Calibration, and System Gain Calibration.

At the bottom of the tab, there are four windows that allow for manually entering and reading back calibration values for the offset calibration register and the gain calibration register. The **Set** button enters the value in the window into the calibration register, while the **Read** button reads the current calibration register value.

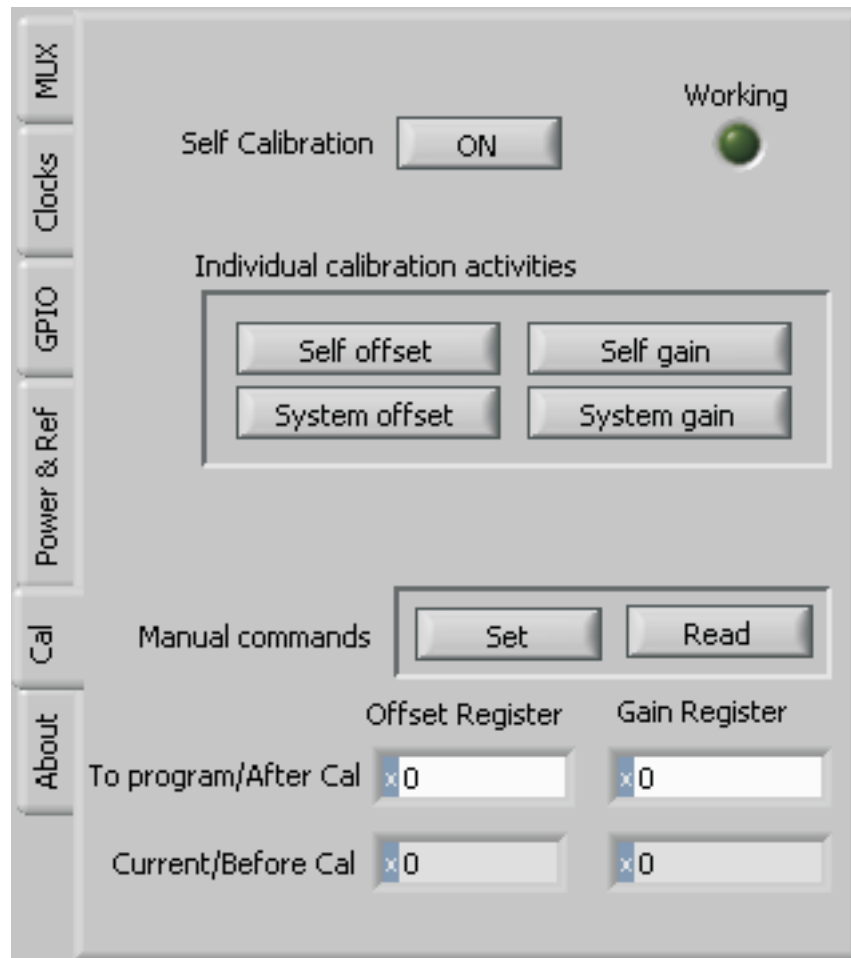
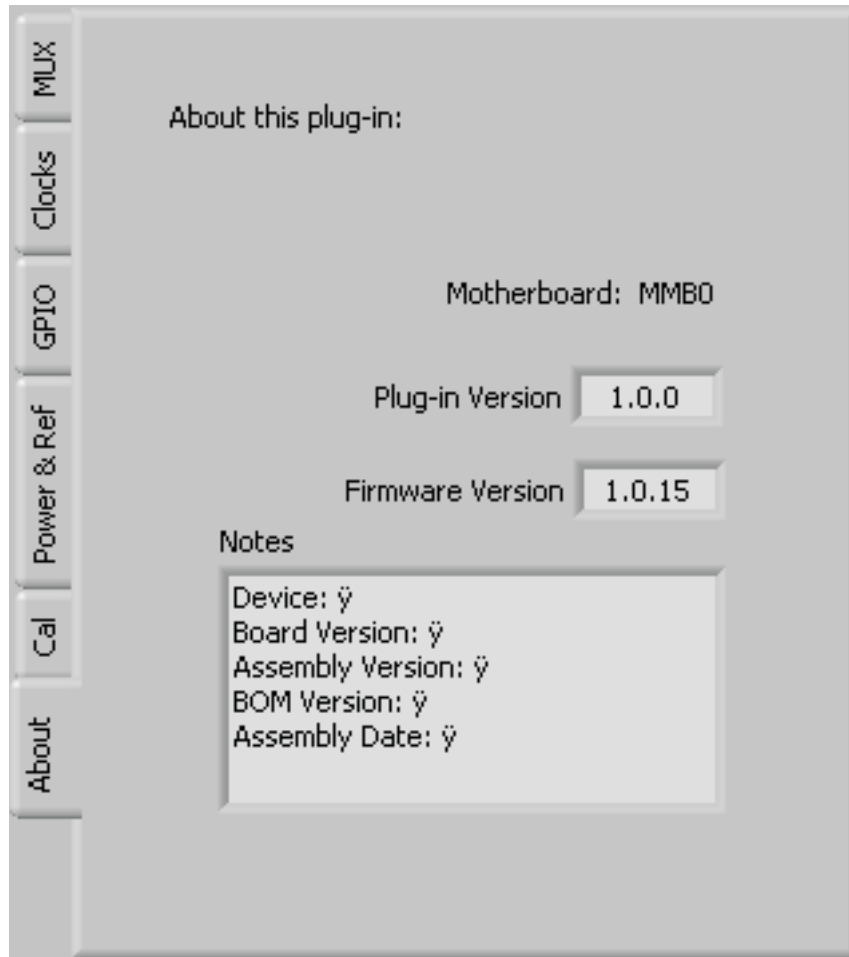

Figure 34. Cal Tab

### 9.1.6 About Tab

The About tab displays information about the EVM and software, as [Figure 35](#) shows.

The Plugin Version and Firmware Version indicators show the version numbers of the plug-in and firmware code, respectively. The Notes indicator may show relevant notes about the plug-in or firmware code, if there are any.



**Figure 35. EVM Software About Tab**

### 9.1.7 Collecting Data

Once you have configured the ADS1256 for your test scenario, pressing the ADCPro **Acquire** button starts the collection of the number of datapoints specified in the Test plug-in *Block Size* control. The ADS1256EVM-PDK plug-in disables all the front panel controls while acquiring, and displays a progress bar as shown in [Figure 36](#).



**Figure 36. Software Progress Indicator**

For more information on testing analog-to-digital converters in general and using ADCPro and Test plug-ins, refer to the [ADCPro User Guide](#).

## 9.2 Troubleshooting

If ADCPro stops responding while the ADS1256EVM-PDK is connected, try unplugging the power supply from the PDK. Unload and reload the plug-in before reapplying power to the PDK.

## 10 Schematics and Layout

A schematic for the ADS1256EVM is appended to this user's guide. The bill of materials is provided in [Table 12](#). [Figure 37](#) through [Figure 40](#) illustrate the ADS1256EVM printed circuit board (PCB) layouts.

**Table 12. ADS1256EVM Bill of Materials**

Item No	Qty	Value	Ref Des	Description	Vendor	Part No
1	1	10kΩ	R1	1/10W 5% chip resistor	Panasonic	ERJ-3GEYJ103V
2	2	47kΩ	R2, R3	1/10W 5% chip resistor	Panasonic	ERJ-3GEYJ473V
3	3	100Ω	RA1, RA2, RA3	Resistor array, eight terminal, four resistor	CTS	744C083101JPTR
4	1	100kΩ	RA4	Resistor array, eight terminal, four resistor	CTS	744C083104JPTR
5	2	18pF	C21, C22	50V ceramic chip capacitor, ±5%, C0G	TDK	C1608C0G1H180JT
6	2	0.1μF	C23, C24	16V ceramic chip capacitor, ±10%, X7R	TDK	C1608X7R1C104KT
7	2	1μF	C3, C18	16V ceramic chip, ±10%, X7R	TDK	C2012X7R1C105KT
8	2	4.7μF	C19, C20	6.3V ceramic chip ±20%, X5R	TDK	C2012X5R0J475KT
9	1	100μF	C4	10V low ESR tantalum capacitor, ±20%	Kemet	T520D107M010ATE055
10	4	10nF	C1, C2, C7, C10	16V PPS chip capacitor, ±2%	Panasonic	ECH-U1C103GX5
11	1		U1	Analog to digital converter	Texas Instruments	ADS1256IDB
12	1		U2	Operational amplifier	Texas Instruments	OPA350UA
13	1		U3	+2.5V voltage reference	Texas Instruments	REF5025ID
14	1		U4	256K I <sup>2</sup> C EEPROM	Microchip	24AA256-I/SN
15	2		J1A, J2A	20 pin SMT plug	Samtec	TSM-110-01-L-DV-P
16	2		J1B, J2B	20 pin SMT socket	Samtec	SSW-110-22-F-D-VS-K
17	1		J3A	10 pin SMT plug	Samtec	TSM-105-01-L-DV-P
18	1		J3B	10 pin SMT socket	Samtec	SSW-105-22-F-D-VS-K
19	3		J6, J7, J8	Three-position header, 0.1 spacing	Samtec	TSW-103-07-L-S
20	1		J5	Four-position header, 0.1in spacing	Samtec	TSW-104-07-L-S
21	1		J4	2 x 2 position header, 0.1in spacing	Samtec	TSW-102-07-L-D
22	1		J10	2 x 3 position header, 0.1in spacing	Samtec	TSW-103-07-L-D
23	1		N/A	ADS1256EVM PWB	Texas Instruments	6450840
24	3		S1, S2, S3	DP3T Switch	E-Switch	EG2305A
25	1		S4	SPDT Switch	NKK	SS12SDP2
26	1		X1	Crystal, SMD	Citizen	HCM49-7.680MABJ-UT
27	8		N/A	Jumper top	Samtec	SNT-100-BK-T
Not Installed			C5, C6, C8, C9, C11, C12, C13, C14, C15, C16, C17			
Not Installed	1		J9	1x2 Position header, 0.1" spacing	Samtec	TSW-102-07-L-S



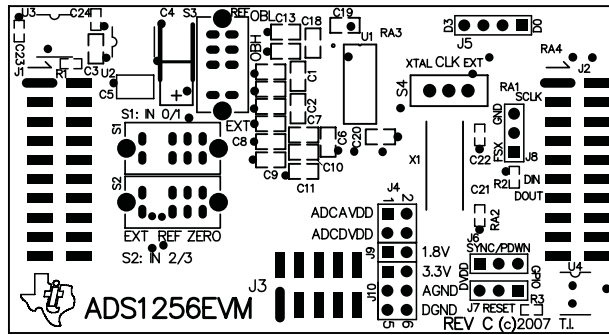

Figure 37. ADS1256EVM PCB: Top-Side Image

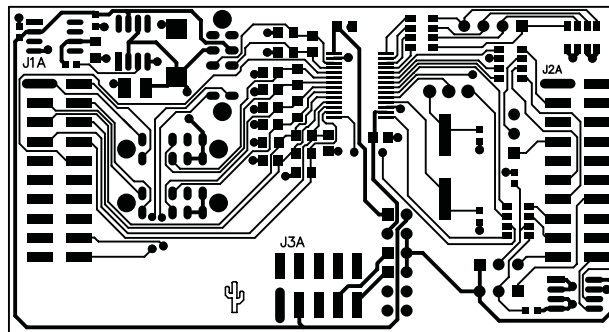

Figure 38. ADS1256EVM PCB: Layer 1

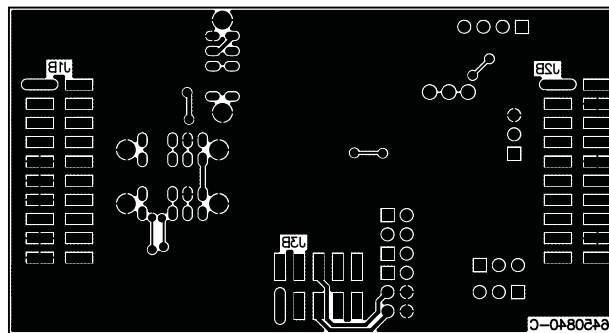

Figure 39. ADS1256EVM PCB: Layer 2

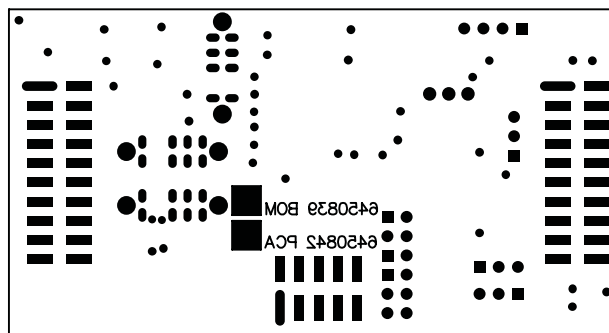

Figure 40. ADS1256EVM PCB: Bottom-Side Image

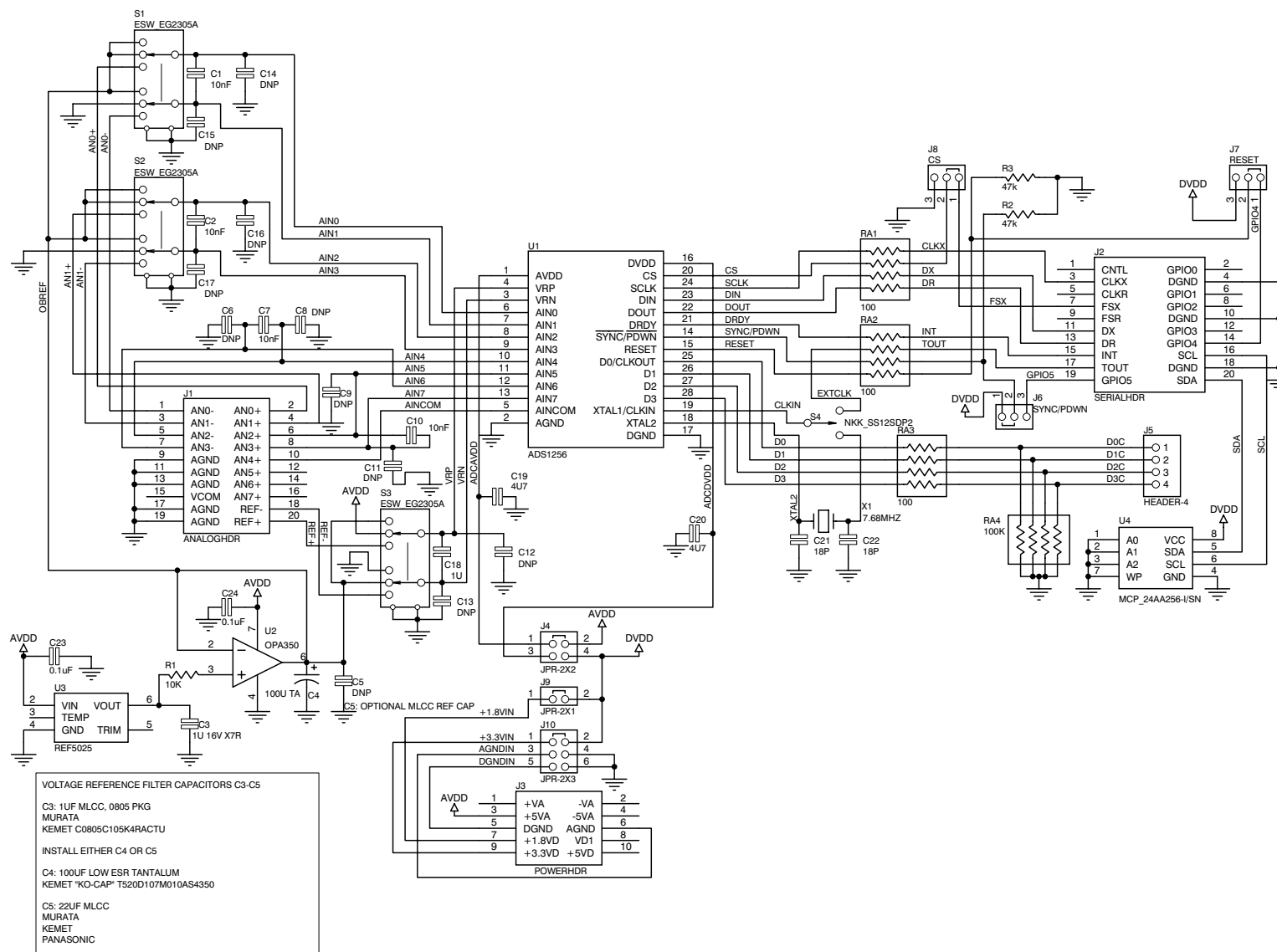

Figure 41. Schematic

---

## Revision History

NOTE: Page numbers for previous revisions may differ from page numbers in the current version.

---

### Changes from D Revision (May 2016) to E Revision Page

- Added *Schematic* image ..... 40
- 

### Changes from C Revision (July 2010) to D Revision Page

- Updated software download links in the *Installing the ADCPro Software* section. .... 15
  - Added *External Wall-Adapter Power-Supply Requirements* section. .... 21
-

## STANDARD TERMS FOR EVALUATION MODULES

1. *Delivery:* TI delivers TI evaluation boards, kits, or modules, including any accompanying demonstration software, components, and/or documentation which may be provided together or separately (collectively, an "EVM" or "EVMs") to the User ("User") in accordance with the terms set forth herein. User's acceptance of the EVM is expressly subject to the following terms.
  - 1.1 EVMs are intended solely for product or software developers for use in a research and development setting to facilitate feasibility evaluation, experimentation, or scientific analysis of TI semiconductor products. EVMs have no direct function and are not finished products. EVMs shall not be directly or indirectly assembled as a part or subassembly in any finished product. For clarification, any software or software tools provided with the EVM ("Software") shall not be subject to the terms and conditions set forth herein but rather shall be subject to the applicable terms that accompany such Software
  - 1.2 EVMs are not intended for consumer or household use. EVMs may not be sold, sublicensed, leased, rented, loaned, assigned, or otherwise distributed for commercial purposes by Users, in whole or in part, or used in any finished product or production system.
2. *Limited Warranty and Related Remedies/Disclaimers:*
  - 2.1 These terms do not apply to Software. The warranty, if any, for Software is covered in the applicable Software License Agreement.
  - 2.2 TI warrants that the TI EVM will conform to TI's published specifications for ninety (90) days after the date TI delivers such EVM to User. Notwithstanding the foregoing, TI shall not be liable for a nonconforming EVM if (a) the nonconformity was caused by neglect, misuse or mistreatment by an entity other than TI, including improper installation or testing, or for any EVMs that have been altered or modified in any way by an entity other than TI, (b) the nonconformity resulted from User's design, specifications or instructions for such EVMs or improper system design, or (c) User has not paid on time. Testing and other quality control techniques are used to the extent TI deems necessary. TI does not test all parameters of each EVM. User's claims against TI under this Section 2 are void if User fails to notify TI of any apparent defects in the EVMs within ten (10) business days after delivery, or of any hidden defects with ten (10) business days after the defect has been detected.
  - 2.3 TI's sole liability shall be at its option to repair or replace EVMs that fail to conform to the warranty set forth above, or credit User's account for such EVM. TI's liability under this warranty shall be limited to EVMs that are returned during the warranty period to the address designated by TI and that are determined by TI not to conform to such warranty. If TI elects to repair or replace such EVM, TI shall have a reasonable time to repair such EVM or provide replacements. Repaired EVMs shall be warranted for the remainder of the original warranty period. Replaced EVMs shall be warranted for a new full ninety (90) day warranty period.
3. *Regulatory Notices:*
  - 3.1 *United States*
    - 3.1.1 *Notice applicable to EVMs not FCC-Approved:*

**FCC NOTICE:** This kit is designed to allow product developers to evaluate electronic components, circuitry, or software associated with the kit to determine whether to incorporate such items in a finished product and software developers to write software applications for use with the end product. This kit is not a finished product and when assembled may not be resold or otherwise marketed unless all required FCC equipment authorizations are first obtained. Operation is subject to the condition that this product not cause harmful interference to licensed radio stations and that this product accept harmful interference. Unless the assembled kit is designed to operate under part 15, part 18 or part 95 of this chapter, the operator of the kit must operate under the authority of an FCC license holder or must secure an experimental authorization under part 5 of this chapter.
    - 3.1.2 *For EVMs annotated as FCC – FEDERAL COMMUNICATIONS COMMISSION Part 15 Compliant:*

### CAUTION

This device complies with part 15 of the FCC Rules. Operation is subject to the following two conditions: (1) This device may not cause harmful interference, and (2) this device must accept any interference received, including interference that may cause undesired operation.

Changes or modifications not expressly approved by the party responsible for compliance could void the user's authority to operate the equipment.

### FCC Interference Statement for Class A EVM devices

*NOTE: This equipment has been tested and found to comply with the limits for a Class A digital device, pursuant to part 15 of the FCC Rules. These limits are designed to provide reasonable protection against harmful interference when the equipment is operated in a commercial environment. This equipment generates, uses, and can radiate radio frequency energy and, if not installed and used in accordance with the instruction manual, may cause harmful interference to radio communications. Operation of this equipment in a residential area is likely to cause harmful interference in which case the user will be required to correct the interference at his own expense.*

## FCC Interference Statement for Class B EVM devices

*NOTE: This equipment has been tested and found to comply with the limits for a Class B digital device, pursuant to part 15 of the FCC Rules. These limits are designed to provide reasonable protection against harmful interference in a residential installation. This equipment generates, uses and can radiate radio frequency energy and, if not installed and used in accordance with the instructions, may cause harmful interference to radio communications. However, there is no guarantee that interference will not occur in a particular installation. If this equipment does cause harmful interference to radio or television reception, which can be determined by turning the equipment off and on, the user is encouraged to try to correct the interference by one or more of the following measures:*

- Reorient or relocate the receiving antenna.
- Increase the separation between the equipment and receiver.
- Connect the equipment into an outlet on a circuit different from that to which the receiver is connected.
- Consult the dealer or an experienced radio/TV technician for help.

### 3.2 Canada

3.2.1 For EVMs issued with an Industry Canada Certificate of Conformance to RSS-210 or RSS-247

#### Concerning EVMs Including Radio Transmitters:

This device complies with Industry Canada license-exempt RSSs. Operation is subject to the following two conditions:

(1) this device may not cause interference, and (2) this device must accept any interference, including interference that may cause undesired operation of the device.

#### Concernant les EVMs avec appareils radio:

Le présent appareil est conforme aux CNR d'Industrie Canada applicables aux appareils radio exempts de licence. L'exploitation est autorisée aux deux conditions suivantes: (1) l'appareil ne doit pas produire de brouillage, et (2) l'utilisateur de l'appareil doit accepter tout brouillage radioélectrique subi, même si le brouillage est susceptible d'en compromettre le fonctionnement.

#### Concerning EVMs Including Detachable Antennas:

Under Industry Canada regulations, this radio transmitter may only operate using an antenna of a type and maximum (or lesser) gain approved for the transmitter by Industry Canada. To reduce potential radio interference to other users, the antenna type and its gain should be so chosen that the equivalent isotropically radiated power (e.i.r.p.) is not more than that necessary for successful communication. This radio transmitter has been approved by Industry Canada to operate with the antenna types listed in the user guide with the maximum permissible gain and required antenna impedance for each antenna type indicated. Antenna types not included in this list, having a gain greater than the maximum gain indicated for that type, are strictly prohibited for use with this device.

#### Concernant les EVMs avec antennes détachables

Conformément à la réglementation d'Industrie Canada, le présent émetteur radio peut fonctionner avec une antenne d'un type et d'un gain maximal (ou inférieur) approuvé pour l'émetteur par Industrie Canada. Dans le but de réduire les risques de brouillage radioélectrique à l'intention des autres utilisateurs, il faut choisir le type d'antenne et son gain de sorte que la puissance isotrope rayonnée équivalente (p.i.r.e.) ne dépasse pas l'intensité nécessaire à l'établissement d'une communication satisfaisante. Le présent émetteur radio a été approuvé par Industrie Canada pour fonctionner avec les types d'antenne énumérés dans le manuel d'usage et ayant un gain admissible maximal et l'impédance requise pour chaque type d'antenne. Les types d'antenne non inclus dans cette liste, ou dont le gain est supérieur au gain maximal indiqué, sont strictement interdits pour l'exploitation de l'émetteur.

### 3.3 Japan

3.3.1 *Notice for EVMs delivered in Japan:* Please see [http://www.tij.co.jp/lstds/ti\\_ja/general/eStore/notice\\_01.page](http://www.tij.co.jp/lstds/ti_ja/general/eStore/notice_01.page) 日本国内に輸入される評価用キット、ボードについては、次のところをご覧ください。  
[http://www.tij.co.jp/lstds/ti\\_ja/general/eStore/notice\\_01.page](http://www.tij.co.jp/lstds/ti_ja/general/eStore/notice_01.page)

3.3.2 *Notice for Users of EVMs Considered "Radio Frequency Products" in Japan:* EVMs entering Japan may not be certified by TI as conforming to Technical Regulations of Radio Law of Japan.

If User uses EVMs in Japan, not certified to Technical Regulations of Radio Law of Japan, User is required to follow the instructions set forth by Radio Law of Japan, which includes, but is not limited to, the instructions below with respect to EVMs (which for the avoidance of doubt are stated strictly for convenience and should be verified by User):

1. Use EVMs in a shielded room or any other test facility as defined in the notification #173 issued by Ministry of Internal Affairs and Communications on March 28, 2006, based on Sub-section 1.1 of Article 6 of the Ministry's Rule for Enforcement of Radio Law of Japan,
2. Use EVMs only after User obtains the license of Test Radio Station as provided in Radio Law of Japan with respect to EVMs, or
3. Use of EVMs only after User obtains the Technical Regulations Conformity Certification as provided in Radio Law of Japan with respect to EVMs. Also, do not transfer EVMs, unless User gives the same notice above to the transferee. Please note that if User does not follow the instructions above, User will be subject to penalties of Radio Law of Japan.

【無線電波を送信する製品の開発キットをお使いになる際の注意事項】 開発キットの中には技術基準適合証明を受けていないものがあります。技術適合証明を受けていないものご使用に際しては、電波法遵守のため、以下のいずれかの措置を取っていただく必要がありますのでご注意ください。

1. 電波法施行規則第6条第1項第1号に基づく平成18年3月28日総務省告示第173号で定められた電波暗室等の試験設備でご使用いただく。
2. 実験局の免許を取得後ご使用いただく。
3. 技術基準適合証明を取得後ご使用いただく。

なお、本製品は、上記の「ご使用にあたっての注意」を譲渡先、移転先に通知しない限り、譲渡、移転できないものとします。

上記を遵守頂けない場合は、電波法の罰則が適用される可能性があることをご留意ください。日本テキサス・インスツルメンツ株式会社  
東京都新宿区西新宿 6 丁目 2 4 番 1 号  
西新宿三井ビル

3.3.3 *Notice for EVMs for Power Line Communication:* Please see [http://www.tij.co.jp/lstds/ti\\_ja/general/eStore/notice\\_02.page](http://www.tij.co.jp/lstds/ti_ja/general/eStore/notice_02.page)  
電力線搬送波通信についての開発キットをお使いになる際の注意事項については、次のところをご覧ください。 [http://www.tij.co.jp/lstds/ti\\_ja/general/eStore/notice\\_02.page](http://www.tij.co.jp/lstds/ti_ja/general/eStore/notice_02.page)

#### 3.4 *European Union*

##### 3.4.1 *For EVMs subject to EU Directive 2014/30/EU (Electromagnetic Compatibility Directive):*

This is a class A product intended for use in environments other than domestic environments that are connected to a low-voltage power-supply network that supplies buildings used for domestic purposes. In a domestic environment this product may cause radio interference in which case the user may be required to take adequate measures.

#### 4 *EVM Use Restrictions and Warnings:*

4.1 EVMS ARE NOT FOR USE IN FUNCTIONAL SAFETY AND/OR SAFETY CRITICAL EVALUATIONS, INCLUDING BUT NOT LIMITED TO EVALUATIONS OF LIFE SUPPORT APPLICATIONS.

4.2 User must read and apply the user guide and other available documentation provided by TI regarding the EVM prior to handling or using the EVM, including without limitation any warning or restriction notices. The notices contain important safety information related to, for example, temperatures and voltages.

##### 4.3 *Safety-Related Warnings and Restrictions:*

4.3.1 User shall operate the EVM within TI's recommended specifications and environmental considerations stated in the user guide, other available documentation provided by TI, and any other applicable requirements and employ reasonable and customary safeguards. Exceeding the specified performance ratings and specifications (including but not limited to input and output voltage, current, power, and environmental ranges) for the EVM may cause personal injury or death, or property damage. If there are questions concerning performance ratings and specifications, User should contact a TI field representative prior to connecting interface electronics including input power and intended loads. Any loads applied outside of the specified output range may also result in unintended and/or inaccurate operation and/or possible permanent damage to the EVM and/or interface electronics. Please consult the EVM user guide prior to connecting any load to the EVM output. If there is uncertainty as to the load specification, please contact a TI field representative. During normal operation, even with the inputs and outputs kept within the specified allowable ranges, some circuit components may have elevated case temperatures. These components include but are not limited to linear regulators, switching transistors, pass transistors, current sense resistors, and heat sinks, which can be identified using the information in the associated documentation. When working with the EVM, please be aware that the EVM may become very warm.

4.3.2 EVMs are intended solely for use by technically qualified, professional electronics experts who are familiar with the dangers and application risks associated with handling electrical mechanical components, systems, and subsystems. User assumes all responsibility and liability for proper and safe handling and use of the EVM by User or its employees, affiliates, contractors or designees. User assumes all responsibility and liability to ensure that any interfaces (electronic and/or mechanical) between the EVM and any human body are designed with suitable isolation and means to safely limit accessible leakage currents to minimize the risk of electrical shock hazard. User assumes all responsibility and liability for any improper or unsafe handling or use of the EVM by User or its employees, affiliates, contractors or designees.

4.4 User assumes all responsibility and liability to determine whether the EVM is subject to any applicable international, federal, state, or local laws and regulations related to User's handling and use of the EVM and, if applicable, User assumes all responsibility and liability for compliance in all respects with such laws and regulations. User assumes all responsibility and liability for proper disposal and recycling of the EVM consistent with all applicable international, federal, state, and local requirements.

5. *Accuracy of Information:* To the extent TI provides information on the availability and function of EVMs, TI attempts to be as accurate as possible. However, TI does not warrant the accuracy of EVM descriptions, EVM availability or other information on its websites as accurate, complete, reliable, current, or error-free.



6. *Disclaimers:*
- 6.1 EXCEPT AS SET FORTH ABOVE, EVMS AND ANY MATERIALS PROVIDED WITH THE EVM (INCLUDING, BUT NOT LIMITED TO, REFERENCE DESIGNS AND THE DESIGN OF THE EVM ITSELF) ARE PROVIDED "AS IS" AND "WITH ALL FAULTS." TI DISCLAIMS ALL OTHER WARRANTIES, EXPRESS OR IMPLIED, REGARDING SUCH ITEMS, INCLUDING BUT NOT LIMITED TO ANY EPIDEMIC FAILURE WARRANTY OR IMPLIED WARRANTIES OF MERCHANTABILITY OR FITNESS FOR A PARTICULAR PURPOSE OR NON-INFRINGEMENT OF ANY THIRD PARTY PATENTS, COPYRIGHTS, TRADE SECRETS OR OTHER INTELLECTUAL PROPERTY RIGHTS.
- 6.2 EXCEPT FOR THE LIMITED RIGHT TO USE THE EVM SET FORTH HEREIN, NOTHING IN THESE TERMS SHALL BE CONSTRUED AS GRANTING OR CONFERRING ANY RIGHTS BY LICENSE, PATENT, OR ANY OTHER INDUSTRIAL OR INTELLECTUAL PROPERTY RIGHT OF TI, ITS SUPPLIERS/LICENSORS OR ANY OTHER THIRD PARTY, TO USE THE EVM IN ANY FINISHED END-USER OR READY-TO-USE FINAL PRODUCT, OR FOR ANY INVENTION, DISCOVERY OR IMPROVEMENT, REGARDLESS OF WHEN MADE, CONCEIVED OR ACQUIRED.
7. *USER'S INDEMNITY OBLIGATIONS AND REPRESENTATIONS.* USER WILL DEFEND, INDEMNIFY AND HOLD TI, ITS LICENSORS AND THEIR REPRESENTATIVES HARMLESS FROM AND AGAINST ANY AND ALL CLAIMS, DAMAGES, LOSSES, EXPENSES, COSTS AND LIABILITIES (COLLECTIVELY, "CLAIMS") ARISING OUT OF OR IN CONNECTION WITH ANY HANDLING OR USE OF THE EVM THAT IS NOT IN ACCORDANCE WITH THESE TERMS. THIS OBLIGATION SHALL APPLY WHETHER CLAIMS ARISE UNDER STATUTE, REGULATION, OR THE LAW OF TORT, CONTRACT OR ANY OTHER LEGAL THEORY, AND EVEN IF THE EVM FAILS TO PERFORM AS DESCRIBED OR EXPECTED.
8. *Limitations on Damages and Liability:*
- 8.1 *General Limitations.* IN NO EVENT SHALL TI BE LIABLE FOR ANY SPECIAL, COLLATERAL, INDIRECT, PUNITIVE, INCIDENTAL, CONSEQUENTIAL, OR EXEMPLARY DAMAGES IN CONNECTION WITH OR ARISING OUT OF THESE TERMS OR THE USE OF THE EVMS , REGARDLESS OF WHETHER TI HAS BEEN ADVISED OF THE POSSIBILITY OF SUCH DAMAGES. EXCLUDED DAMAGES INCLUDE, BUT ARE NOT LIMITED TO, COST OF REMOVAL OR REINSTALLATION, ANCILLARY COSTS TO THE PROCUREMENT OF SUBSTITUTE GOODS OR SERVICES, RETESTING, OUTSIDE COMPUTER TIME, LABOR COSTS, LOSS OF GOODWILL, LOSS OF PROFITS, LOSS OF SAVINGS, LOSS OF USE, LOSS OF DATA, OR BUSINESS INTERRUPTION. NO CLAIM, SUIT OR ACTION SHALL BE BROUGHT AGAINST TI MORE THAN TWELVE (12) MONTHS AFTER THE EVENT THAT GAVE RISE TO THE CAUSE OF ACTION HAS OCCURRED.
- 8.2 *Specific Limitations.* IN NO EVENT SHALL TI'S AGGREGATE LIABILITY FROM ANY USE OF AN EVM PROVIDED HEREUNDER, INCLUDING FROM ANY WARRANTY, INDEMNITY OR OTHER OBLIGATION ARISING OUT OF OR IN CONNECTION WITH THESE TERMS, , EXCEED THE TOTAL AMOUNT PAID TO TI BY USER FOR THE PARTICULAR EVM(S) AT ISSUE DURING THE PRIOR TWELVE (12) MONTHS WITH RESPECT TO WHICH LOSSES OR DAMAGES ARE CLAIMED. THE EXISTENCE OF MORE THAN ONE CLAIM SHALL NOT ENLARGE OR EXTEND THIS LIMIT.
9. *Return Policy.* Except as otherwise provided, TI does not offer any refunds, returns, or exchanges. Furthermore, no return of EVM(s) will be accepted if the package has been opened and no return of the EVM(s) will be accepted if they are damaged or otherwise not in a resalable condition. If User feels it has been incorrectly charged for the EVM(s) it ordered or that delivery violates the applicable order, User should contact TI. All refunds will be made in full within thirty (30) working days from the return of the components(s), excluding any postage or packaging costs.
10. *Governing Law:* These terms and conditions shall be governed by and interpreted in accordance with the laws of the State of Texas, without reference to conflict-of-laws principles. User agrees that non-exclusive jurisdiction for any dispute arising out of or relating to these terms and conditions lies within courts located in the State of Texas and consents to venue in Dallas County, Texas. Notwithstanding the foregoing, any judgment may be enforced in any United States or foreign court, and TI may seek injunctive relief in any United States or foreign court.

## IMPORTANT NOTICE AND DISCLAIMER

TI PROVIDES TECHNICAL AND RELIABILITY DATA (INCLUDING DATASHEETS), DESIGN RESOURCES (INCLUDING REFERENCE DESIGNS), APPLICATION OR OTHER DESIGN ADVICE, WEB TOOLS, SAFETY INFORMATION, AND OTHER RESOURCES "AS IS" AND WITH ALL FAULTS, AND DISCLAIMS ALL WARRANTIES, EXPRESS AND IMPLIED, INCLUDING WITHOUT LIMITATION ANY IMPLIED WARRANTIES OF MERCHANTABILITY, FITNESS FOR A PARTICULAR PURPOSE OR NON-INFRINGEMENT OF THIRD PARTY INTELLECTUAL PROPERTY RIGHTS.

These resources are intended for skilled developers designing with TI products. You are solely responsible for (1) selecting the appropriate TI products for your application, (2) designing, validating and testing your application, and (3) ensuring your application meets applicable standards, and any other safety, security, or other requirements. These resources are subject to change without notice. TI grants you permission to use these resources only for development of an application that uses the TI products described in the resource. Other reproduction and display of these resources is prohibited. No license is granted to any other TI intellectual property right or to any third party intellectual property right. TI disclaims responsibility for, and you will fully indemnify TI and its representatives against, any claims, damages, costs, losses, and liabilities arising out of your use of these resources.

TI's products are provided subject to TI's Terms of Sale ([www.ti.com/legal/termsofsale.html](http://www.ti.com/legal/termsofsale.html)) or other applicable terms available either on [ti.com](http://ti.com) or provided in conjunction with such TI products. TI's provision of these resources does not expand or otherwise alter TI's applicable warranties or warranty disclaimers for TI products.

Mailing Address: Texas Instruments, Post Office Box 655303, Dallas, Texas 75265  
Copyright © 2018, Texas Instruments Incorporated