

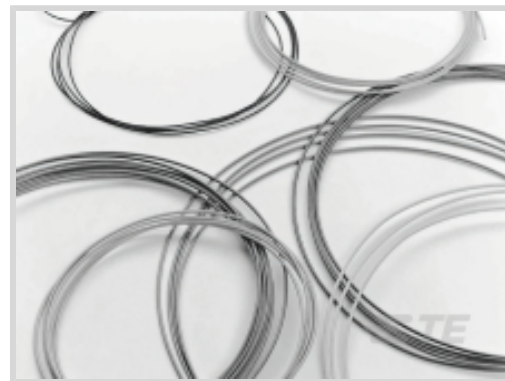

Wire & Cable > Hook Up Wire



Cable Type: **Spec 44**

Voltage Rating: **600 V**

Insulation Material: **Modified Radiation Cross-linked PVDF**

Conductor Material: **Tin-Coated Copper**

Wire Size: **22 AWG**

Features

Product Type Features

Shielded	Yes
Product Classification	High Performance - Spec 44, 55 & RCW
Cable Type	Spec 44

Electrical Characteristics

Voltage Rating	600 V
----------------	-------

Body Features

Jacket Color	White
Wire Color	Black
Insulation Material	Modified Radiation Cross-linked PVDF
Conductor Material	Tin-Coated Copper

Dimensions

Wire Size	22 AWG
-----------	--------

Usage Conditions

Operating Temperature Range	-65 – 150 °C
-----------------------------	--------------

Product Compliance

[For compliance documentation, visit the product page on TE.com>](#)

EU RoHS Directive 2011/65/EU	Compliant
------------------------------	-----------



EU ELV Directive 2000/53/EC	Compliant
China RoHS 2 Directive MIIT Order No 32, 2016	No Restricted Materials Above Threshold
EU REACH Regulation (EC) No. 1907/2006	Current ECHA Candidate List: JAN 2019 (197) Candidate List Declared Against: JAN 2019 (197)
Halogen Content	Out of Scope - excluded from Halogen requirements
Solder Process Capability	Not applicable for solder process capability

Product Compliance Disclaimer

This information is provided based on reasonable inquiry of our suppliers and represents our current actual knowledge based on the information they provided. This information is subject to change. The part numbers that TE has identified as EU RoHS compliant have a maximum concentration of 0.1% by weight in homogenous materials for lead, hexavalent chromium, mercury, PBB, PBDE, DBP, BBP, DEHP, DIBP, and 0.01% for cadmium, or qualify for an exemption to these limits as defined in the Annexes of Directive 2011/65/EU (RoHS2). Finished electrical and electronic equipment products will be CE marked as required by Directive 2011/65/EU. Components may not be CE marked. Additionally, the part numbers that TE has identified as EU ELV compliant have a maximum concentration of 0.1% by weight in homogenous materials for lead, hexavalent chromium, and mercury, and 0.01% for cadmium, or qualify for an exemption to these limits as defined in the Annexes of Directive 2000/53/EC (ELV). Regarding the REACH Regulations, TE's information on SVHC in articles for this part number is still based on the European Chemical Agency (ECHA) 'Guidance on requirements for substances in articles' (Version: 2, April 2011), applying the 0.1% weight on weight concentration threshold at the finished product level. TE is aware of the European Court of Justice ruling of September 10th, 2015 also known as O5A (Once An Article Always An Article) stating that, in case of 'complex object', the threshold for a SVHC must be applied to both the product as a whole and simultaneously to each of the articles forming part of its composition. TE has evaluated this ruling based on the new ECHA "Guidance on requirements for substances in articles" (June 2017, version 4.0) and will be updating its statements accordingly.

Compatible Parts

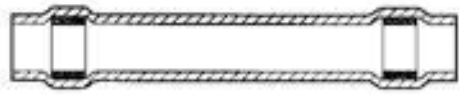

TE Part # 650074-000
[D-436-36](#)

Customers Also Bought



TE Part # EF9244-000
[TXR40AZ00-1212BI](#)



TE Part # 396931-000
[55A0111-26-901](#)



TE Part # 216084-000
[55A0111-26-93](#)



TE Part # 8375493001
[55A4121-22-2/6-9](#)

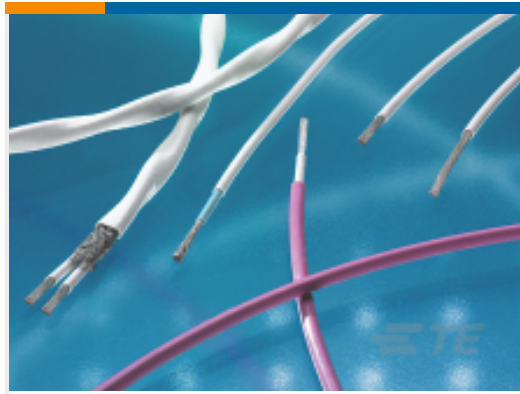

TE Part #7588593001
55A4121-24-2/6-9

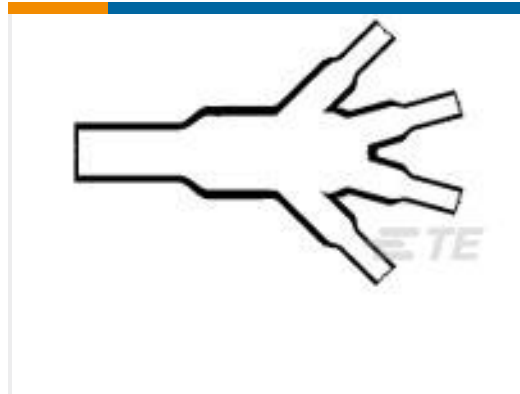

TE Part #525451-000
562A043-100-0

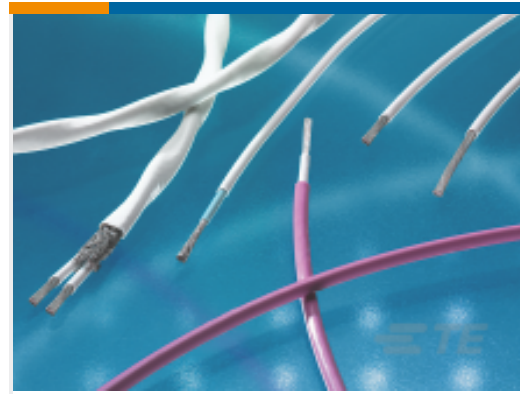

TE Part #CT99313001
55A4131-24-2/6/9-9



TE Part #YDTS24Z11-
35PEV001
RECP ASSY

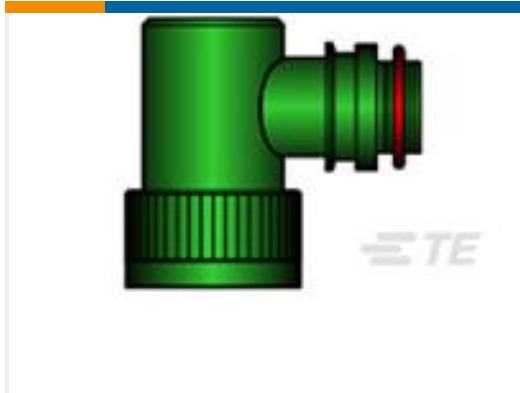

TE Part #CZ4490-000
TXR40AZ90-1007BI

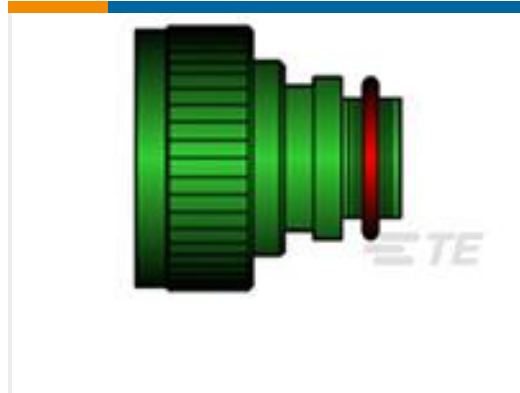

TE Part #EF4793-000
TXR41AZ00-1610BI

Documents

Product Drawings

44A1111-22-0-9

English

Datasheets & Catalog Pages

1654025_Sec9_SPEC44

English