

THIS DRAWING IS UNPUBLISHED.

RELEASED FOR PUBLICATION

-, 2005.

© COPYRIGHT 2005 By -

ALL RIGHTS RESERVED.

REVISIONS

P	LTR	DESCRIPTION	DATE	DWN	APVD
	D4	REVISED PER ECO-20-000020	2JAN2020	A.L	H.L

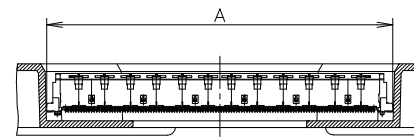
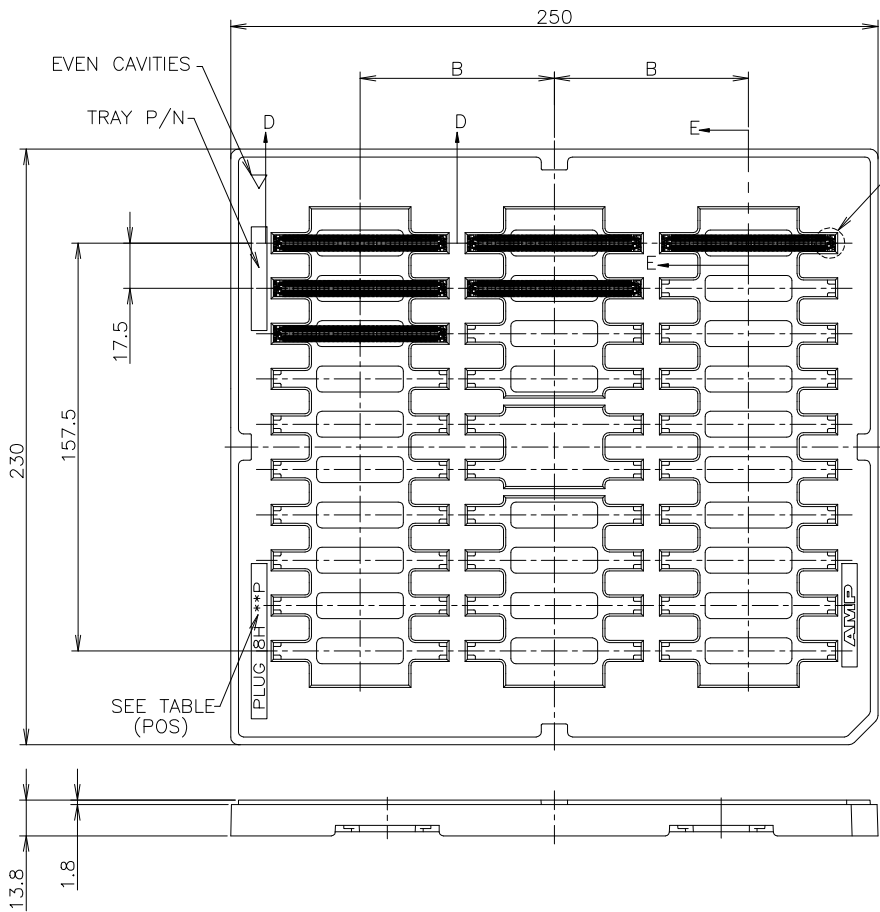

SECT. D-D (SCALE 2:1) (CONNECTOR NOT SECTION)

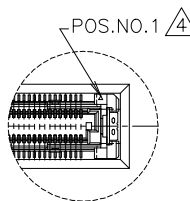

DETAIL C (SCALE 2:1)

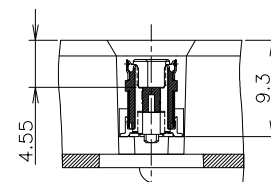

SECT. E-E (SCALE 2:1)

WITHOUT PICK UP CAP

THIS DRAWING IS A CONTROLLED DOCUMENT.

DWN S. CHIEN 26SEP05	TE Connectivity Ltd.	
CHK T. FUTATSUGI 26SEP05	NAME	
APVD W. KODAMA 26SEP05	PRODUCT SPEC	
108-5560	APPLICATION SPEC	
WEIGHT	SIZE A3	CAGE CODE 00779
CUSTOMER DRAWING	DRAWING NO C=6318491	RESTRICTED TO
SCALE 1:2	SHEET 1 OF 5	REV D4

TE Connectivity Ltd.

HARD TRAY ASSY  
FH 0.5BTB CONNECTOR 220POS  
PLUG 8H WITH GROUND PLATE

DIMENSIONS:	TOLERANCES UNLESS OTHERWISE SPECIFIED:
MM	
0 PLC	± 0.3
1 PLC	± 0.3
2 PLC	± 0.3
3 PLC	± 0.3
4 PLC	± 0.3
ANGLES	± 3'

YES	3	30	75	61.8	220	8-6318491-6
NO	3	30	75	61.8	220	3-6318491-6
SEALANT	ROW	QTY	B	A	POS.	PART NO.

4

3

2

1

THIS DRAWING IS UNPUBLISHED.

RELEASED FOR PUBLICATION

,2005.

© COPYRIGHT 2005 By -

ALL RIGHTS RESERVED.

REVISIONS

P	LTR	DESCRIPTION	DATE	DWN	APVD
-	-	SEE SHEET 1	-	-	-

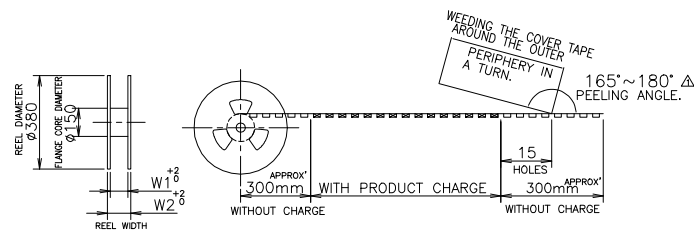
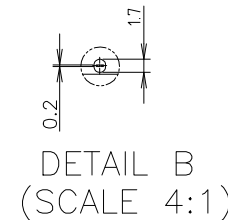
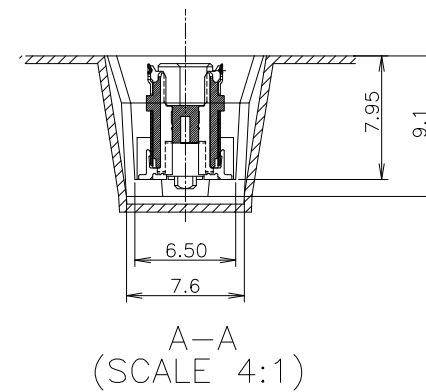
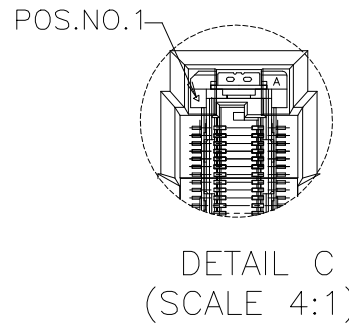
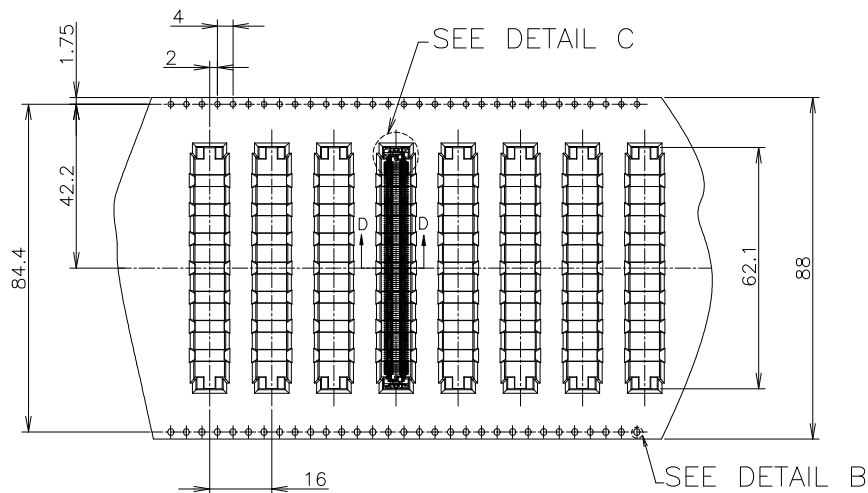

WITHOUT PICK UP CAP

NO	Y	400	93.5	88.5	220	2078455-1	3-5353619-6	4-6318491-6
SEALANT	TOOLING AVAIL	QTY/REEL	W2	W1	POS.	EMBOSS P/N	CONN P/N	PART NO.

THIS DRAWING IS A CONTROLLED DOCUMENT.

DWN S. CHIEN 26SEP05

CHK T. FUTATSUGI 26SEP05

APVD W. KODAMA 26SEP05

PRODUCT SPEC

108-5560

APPLICATION SPEC

NAME

HARD TRAY ASSY

FH 0.5BTB CONNECTOR 220POS

PLUG 8H WITH GROUND PLATE

SIZE A3 CAGE CODE 00779 DRAWING NO. C=6318491 RESTRICTED TO

MATERIAL FINISH WEIGHT CUSTOMER DRAWING SCALE 1:2 SHEET 2 OF 5 REV D4

4

3

2

1

THIS DRAWING IS UNPUBLISHED.

RELEASED FOR PUBLICATION

,2005.

© COPYRIGHT 2005 By -

ALL RIGHTS RESERVED.

REVISIONS

P	LTR	DESCRIPTION	DATE	DWN	APVD
-	-	SEE SHEET 1	-	-	-

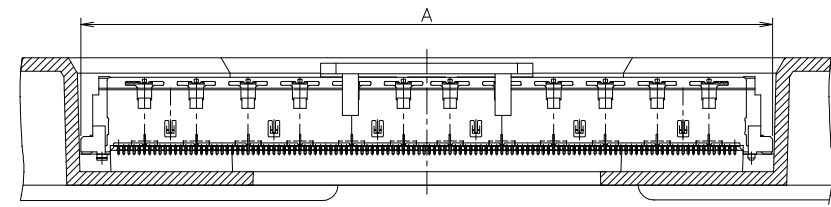
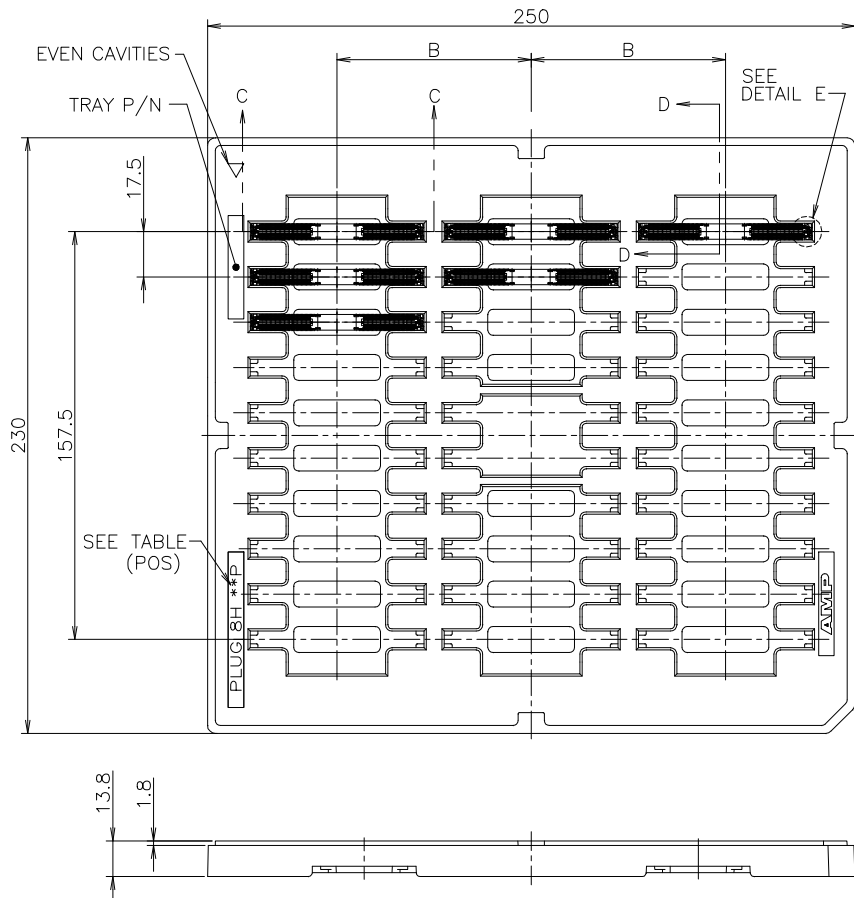

SECT. C-C (SCALE 2:1)

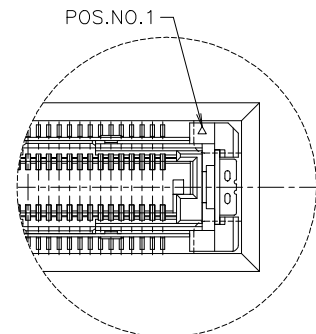

DETAIL E (SCALE 4:1)

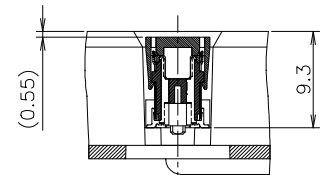

SECT. D-D (SCALE 2:1)

WITH PICK UP CAP

NATURAL	NO	3	30	75	61.8	220	6-6318491-6
BLACK	NO	3	30	75	61.8	220	9-6318491-6
CAP COLOR	SEALANT	ROW	QTY	B	A	POS.	PART NO.

THIS DRAWING IS A CONTROLLED DOCUMENT.

DIMENSIONS: MM		TOLERANCES UNLESS OTHERWISE SPECIFIED:	
		0 PLC	± 0.3
		1 PLC	± 0.3
		2 PLC	± 0.3
		3 PLC	± 0.3
		4 PLC	± 0.3
		ANGLES	± 3'
MATERIAL	-	FINISH	-

DWN	S. CHIEN	26SEP05
CHK	T. FUTATSUGI	26SEP05
APVD	W. KODAMA	26SEP05
PRODUCT SPEC	108-5560	
APPLICATION SPEC	-	
WEIGHT	-	
CUSTOMER DRAWING		

				TE Connectivity Ltd.			
				NAME			
HARD TRAY ASSY				FH 0.5BTB CONNECTOR 220POS			
PLUG 8H WITH GROUND PLATE				RESTRICTED TO			
SIZE	CAGE CODE	DRAWING NO					
A3	00779	C=6318491					
SCALE		1:2	SHEET		3 OF 5	REV	
						D4	

4 3 2 1

THIS DRAWING IS UNPUBLISHED. RELEASED FOR PUBLICATION NOV. 1996. ALL RIGHTS RESERVED.

© COPYRIGHT 1996 By -

REVISIONS

P	LTR	DESCRIPTION	DATE	DWN	APVD
-	-	SEE SHEET 1	-	-	-

SECT. Z-Z  
(SIGNAL POSITION)

SECT. Y-Y  
(GROUND POSITION)

NOTE:

① MATERIAL ; HOUSING : HIGH TEMP THERMO PLASTIC UL94V-0  
CONTACT : COPPER ALLOY  
SOLDER PEG : COPPER ALLOY

② FINISH ; SIGNAL CONTACT : UNDER PL Ni 0.0013mm MIN ALL OVER.  
CONTACT AREA 0.0002mm MIN Au PL.  
SOLDERING AREA 0.001mm MIN TIN PL.  
GROUND CONTACT : UNDER PL Ni 0.0013mm MIN ALL OVER.  
CONTACT AREA 0.0002mm MIN Au PL.  
SOLDERING AREA 0.001mm MIN TIN PL.  
SOLDER PEG : 0.001mm MIN TIN PL. OVER  
0.0013mm MIN Ni PL ALL OVER.

③ THIS POSITION IS GROUND CIRCUIT.

④ THIS PRODUCT WAS COATED BY FLUX-PENETRATION-INHIAITING AGENT.

59.5	57.7	61.8	57.1	54.5	220	BLACK	X-6318491-6
T	S	Q	P	N	POS.	HSG COLOR	PART NO.

THIS DRAWING IS A CONTROLLED DOCUMENT.

DIMENSIONS: MM		TOLERANCES UNLESS OTHERWISE SPECIFIED:	
		0 PLC	± 0.3
		1 PLC	± 0.3
		2 PLC	± 0.3
		3 PLC	± 0.3
		4 PLC	± 0.3
		4 PLC	± 0.3
		ANGLES	± 3'
MATERIAL	①	FINISH	②

DWN	CHK	APVD	PRODUCT SPEC	APPLICATION SPEC	WEIGHT	CUSTOMER DRAWING
-----	-----	------	--------------	------------------	--------	------------------

**TE** TE Connectivity Ltd.

NAME				RESTRICTED TO			
HARD TRAY ASSY				FH 0.5BTB CONNECTOR 220POS			
PLUG 8H WITH GROUND PLATE				DRAWING NO			
SIZE	CAGE CODE	DRAWING NO		RESTRICTED TO			
A3	00779	C=6318491		SCALE 4:1 SHEET 4 OF 5 REV D4			

1470-19 (1/15)

THIS DRAWING IS UNPUBLISHED.

RELEASED FOR PUBLICATION

NOV ,1996.

© COPYRIGHT 1996 By -

ALL RIGHTS RESERVED.

REVISIONS

P	LTR	DESCRIPTION	DATE	DWN	APVD
-	-	SEE SHEET 1	-	-	-

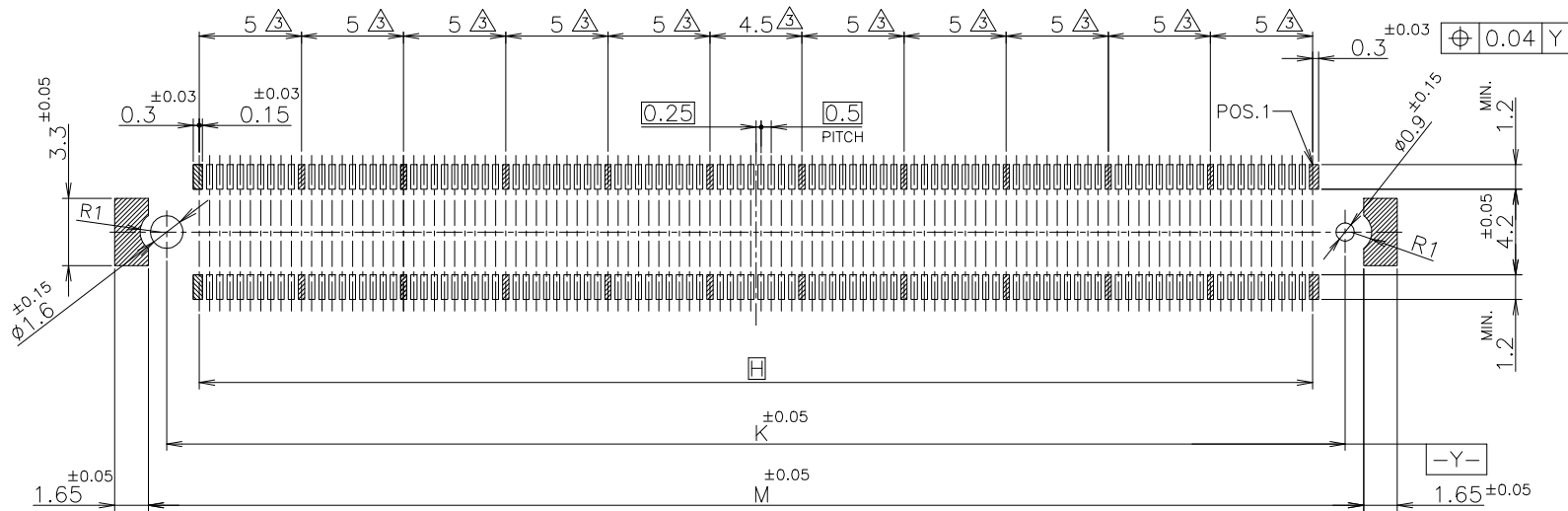

REFERENCE P.C. BOARD LAYOUT

59.5	57.7	54.5	220	X-6318491-6
M	K	H	POS	PART NO.

THIS DRAWING IS A CONTROLLED DOCUMENT.		DWN		TE Connectivity Ltd.			
DIMENSIONS: MM		CHK				NAME	
		APVD				HARD TRAY ASSY FH 0.5BTB CONNECTOR 220POS PLUG 8H WITH GROUND PLATE	
TOLERANCES UNLESS OTHERWISE SPECIFIED:		PRODUCT SPEC		SIZE			
0 PLC ± 0.3 1 PLC ± 0.3 2 PLC ± 0.3 3 PLC ± 0.3 4 PLC ± 0.3 ANGLES ± 3°		APPLICATION SPEC		CAGE CODE			
MATERIAL		WEIGHT		DRAWING NO			
		CUSTOMER DRAWING		A3 00779 C=6318491			
FINISH		SCALE		SHEET			
		4:1		5 OF 5			
				REV			
				D4			