

LR • LS

LR

**MAGNETIC LATCHING FOUR POLE
HALF SIZE HIGH-PERFORMANCE RELAY**

DESIGNED TO MIL-R-39016

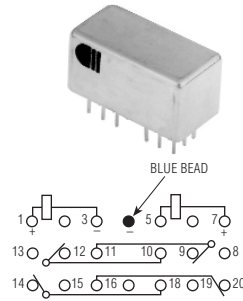

TERMINAL VIEW

STANDARD SCHEMATIC Contacts will switch from the indicated position when either coil is energized with polarity as shown.

FEATURES

- Hermetically sealed
- Up to 2 amps switching
- High shock & vibration ratings
- Optional terminals & mounting styles
- 4 form C hi-density latching design

LS

**MAGNETIC LATCHING HALF SIZE
HIGH-PERFORMANCE RELAY**

DESIGNED TO MIL-R-39016/45

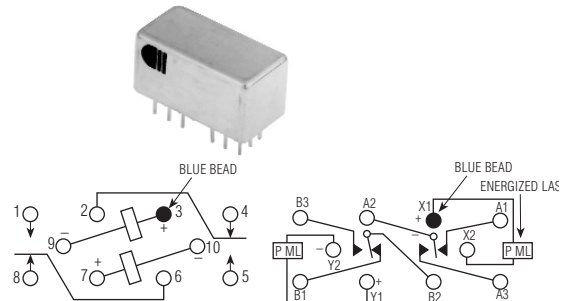

TERMINAL VIEW

STANDARD SCHEMATIC Contacts will switch from the indicated position when either coil is energized with polarity as shown.

FEATURES

- Hermetically sealed
- Up to 2 amps switching
- High shock & vibration ratings
- Optional terminals & mounting styles
- Latching design

MIL-R-39016/45 SCHEMATIC Contacts will switch from the indicated position when either coil is energized with polarity as shown.

ELECTRICAL CHARACTERISTICS

CONTACT ARRANGEMENT

LS: 2 Form C (DPDT)
LR: 4 Form C (4PDT)

CONTACT MATERIAL

Stationary:
Gold plated hardened silver alloy
Moveable:
Gold plated hardened silver alloy

CONTACT RESISTANCE

Before Life: 50 milliohms max.
(measured at 10 mA @ 6 Vdc)

After Life: 100 milliohms max.
(measured @ 2 A @ 28 Vdc)

MECHANICAL LIFE EXPECTANCY

1 million operations min.

COIL VOLTAGE

5 to 48 Vdc

COIL POWER

1.0 watts max.

DUTY CYCLE

Continuous

PICK-UP VOLTAGE

Approximately 50% of nominal coil voltage

PICK-UP SENSITIVITY

170 mW

CONTACT RATINGS

CONTACT LOAD	TYPE	OPERATIONS MIN.
2 A @ 28 Vdc	Resistive	100,000
0.3 A @ 115 Vac, 60 Hz & 400 Hz	Resistive	100,000
0.75 A @ 28 Vdc	Inductive (200mH)	100,000
0.1 A @ 28 Vdc	Intermediate	50,000
0.160 A @ 28 Vdc	Lamp	100,000
30 μ A @ 50 mVdc	Low Level	1,000,000

RF PERFORMANCE (LS ONLY)

FREQUENCY (MHz)	RF LOSSES (dB)	VSWR	ISOLATION (dB)
100	0.1	1.15:1	38
500	0.3	1.19:1	31
1000	0.6	1.32:1	45

LR-LS

OPERATING CHARACTERISTICS

TIMING

Set-Reset Time:
5.0 ms max.

CONTACT BOUNCE

2.0 ms max. (LS)
5.0 ms max. (LR)

DIELECTRIC WITHSTANDING VOLTAGE

Between Open Contacts:

500 Vrms 60 Hz (LS)
350 Vrms 60 Hz (LR)

Between Adjacent Contacts:

1000 Vrms 60 Hz (LS)
500 Vrms 60 Hz (LR)

Between Contacts and Coil:

1000 Vrms 60 Hz (LS)
500 Vrms 60 Hz (LR)

INSULATION RESISTANCE

10,000 megohms min. @ 500 Vdc

ENVIRONMENTAL CHARACTERISTICS

TEMPERATURE RANGE

-65°C to +125°C

WEIGHT

.46 oz (13 gms) max.

VIBRATION RESISTANCE

Standard: 20 G's, 10 to 2,000 Hz
QPL Equiv: 30 G's, 10 to 2,500 Hz

SHOCK RESISTANCE

100 G's, 6 ± 1 ms

QPL EQUIVALENT

MIL-R-39016/45 (LS)
MIL-R-39016 (LR)

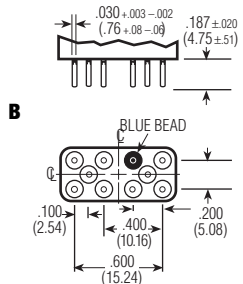
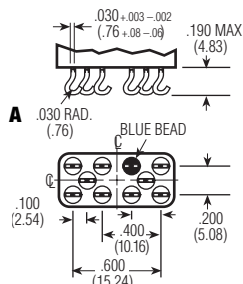

LS TERMINALS

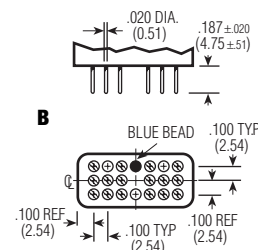
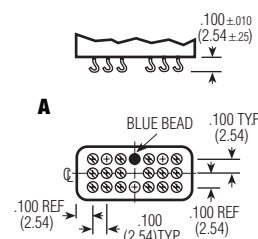

LR TERMINALS

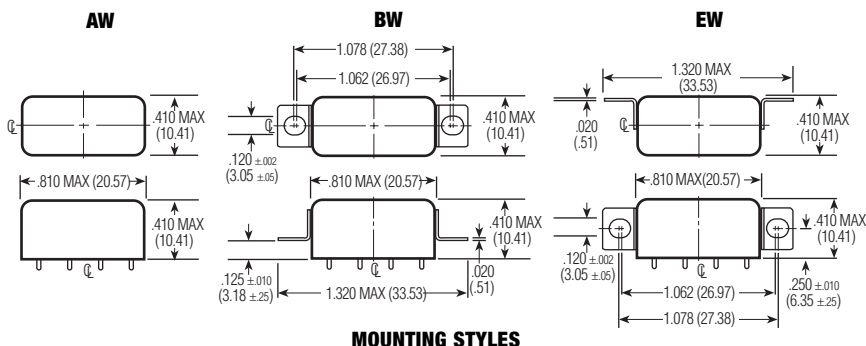

MOUNTING STYLES

STANDARD COIL DATA

NOM. COIL VOLTAGE (Vdc)	COIL RESISTANCE IN OHMS ±10% @ 25°C	PICKUP VOLTAGE Vdc (MAX.) @ 25°C	PICKUP VOLTAGE Vdc (MAX.) @ 125°C	PICKUP VOLTAGE Vdc (MIN.) @ 25°C	PICKUP VOLTAGE Vdc (MIN.) @ -65°C	NOM. COIL POWER (mW) @ 25°C	MAX. COIL VOLTAGE	COIL DESIG.
5.0	45	2.7	3.8	1.6	1.0	556	6.7	5
6.0	63	3.25	4.5	2.0	1.3	571	8.0	6
12.0	254	6.5	9.0	4.0	2.6	567	16.0	12
26.5	1,000	13.0	18.0	8.0	5.2	702	32.0	24
48.0	3,800	26.0	36.0	16.0	10.4	606	64.0	48

SPECIFYING A PART NUMBER EXAMPLE:

TYPE	MOUNTINGS	CONTACTS	COILS	TERMINALS
LR	BW-	4C-	24	B
LS	BW-	2C-	24	B

