

**Slide Switches, Instrumentation Grade**

SEE PAGE B20 FOR PRODUCT SPECIFICATIONS

**B**  
MSS Series

4P3T



MSS4300R

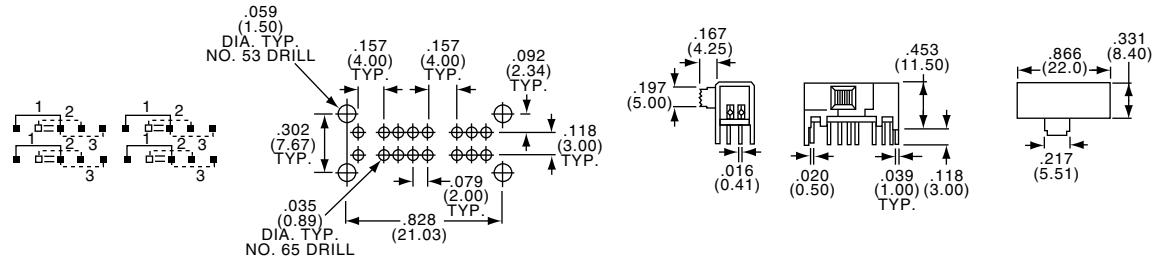

Tyco Electronics	Alcoswitch	Plating
7-1437576-7	MSS4300R	Silver
7-1437576-8	MSS4300RG	Gold

4P3T



MSS4350R

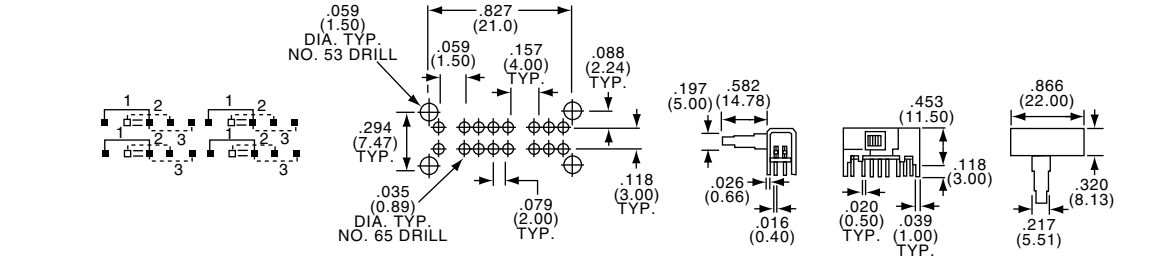

Tyco Electronics	Alcoswitch	Plating
8-1437576-0	MSS4350R	Silver
8-1437576-1	MSS4350RG	Gold

6PDT



MSS6200

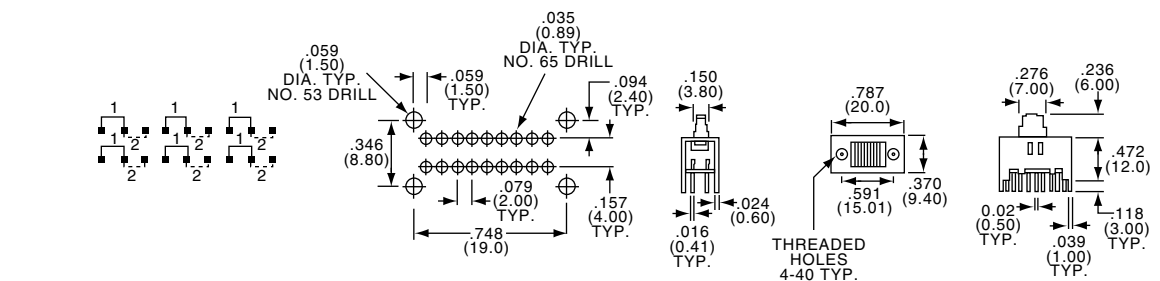

Tyco Electronics	Alcoswitch	Plating
8-1437576-8	MSS6200	Silver
8-1437576-9	MSS6200G	Gold

**Slide Switches, Instrumentation Grade**

SEE PAGE B20 FOR PRODUCT SPECIFICATIONS

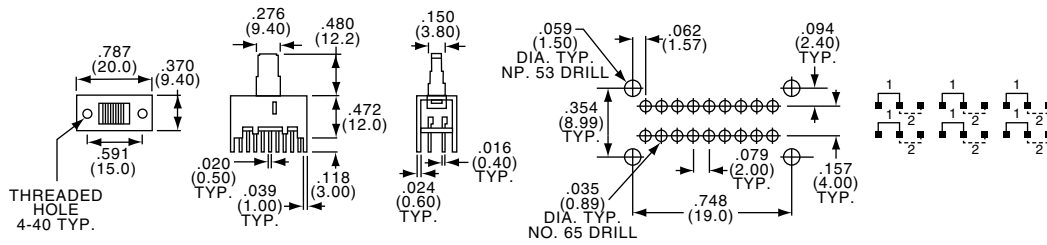

6PDT



MSS6250

Tyco Electronics	Alcoswitch	Plating
9-1437576-0	MSS6250	Silver

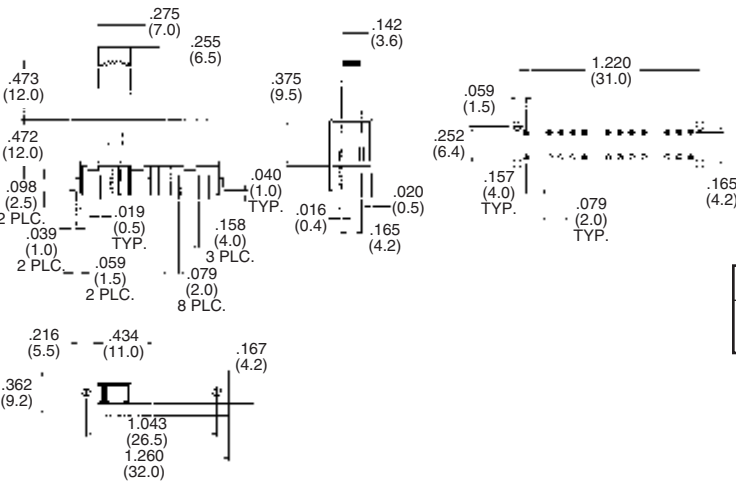

Tyco Electronics	Alcoswitch	Plating
9-1437576-3	MSS6350	Silver
—	MSS6350G	Gold

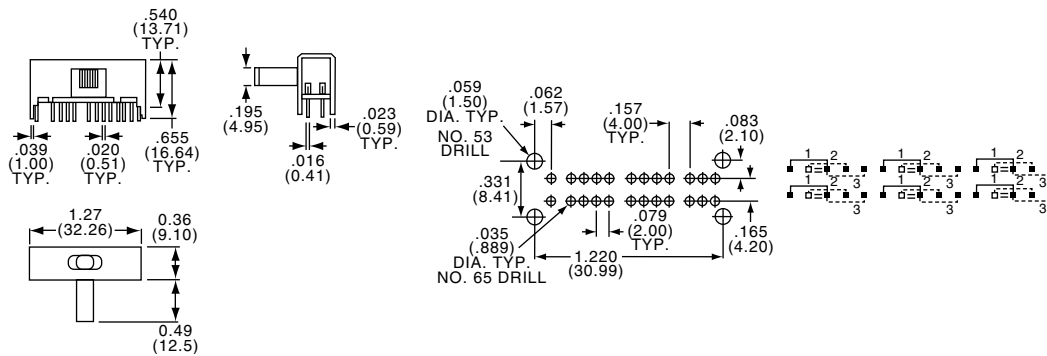

6P3T



MSS6350R

Tyco Electronics	Alcoswitch	Plating
9-1437576-4	MSS6350R	Silver
—	MSS6350RG	Gold

**Slide Switches, Instrumentation Grade**

**MATERIAL SPECIFICATIONS:**

Contacts .....Silver or gold over copper alloy  
 Case Material .....Cold rolled steel  
 Actuator Material .....Polyester UL94V-0  
 Terminals/Fixed Contacts.....Gold or silver plate over copper alloy  
 Terminal Seal .....Epoxy

**TYPICAL PERFORMANCE CHARACTERISTICS:**

Contact Rating .....Gold: 0.4 VA 20 VDC or peak AC  
 Silver: 300 mA @ 125 VAC  
 Initial Contact Resistance .....30 Milliohms max.  
 Contact Timing.....Make before break  
 Insulation Resistance .....1,000 Megohms min.  
 Dielectric Strength .....500 Volts RMS @ sea level  
 Actuation Force .....600±300/470 Grams average  
 Actuator Travel.....0.079" (2.01) approximate  
 Life Expectancy .....Up to 15,000 Cycles

**ENVIRONMENTAL SPECIFICATIONS:**

Operating Temperature.....-4°F to +185°F (-20°C to +85°C)  
 Storage Temperature.....-40°F to +212°F (-40°C to +100°C)  
 Solder Heat Resistance.....See page M3-4

**SP3T**

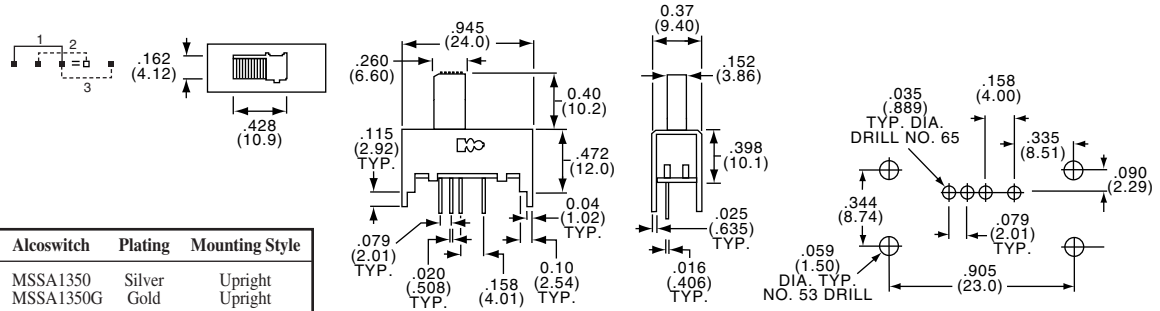

MSSA1350

Tyco Electronics	Alcoswitch	Plating	Mounting Style
3-1437580-3	MSSA1350	Silver	Upright
3-1437580-4	MSSA1350G	Gold	Upright

**SP3T**

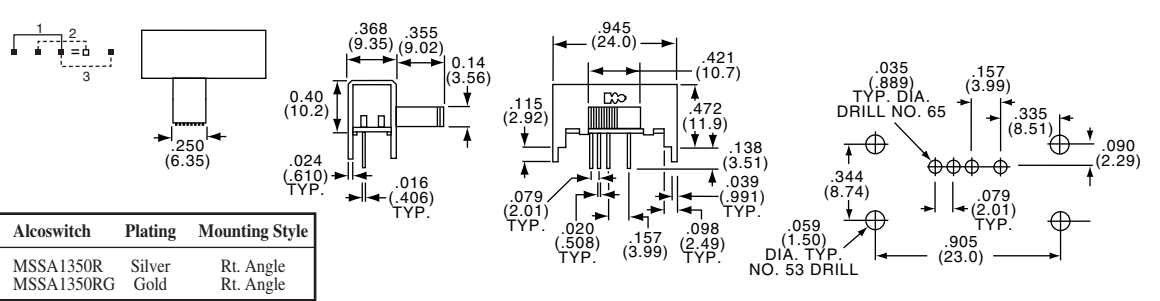

MSSA1350R

Tyco Electronics	Alcoswitch	Plating	Mounting Style
3-1437580-5	MSSA1350R	Silver	Rt. Angle
3-1437580-6	MSSA1350RG	Gold	Rt. Angle

**SP4T**

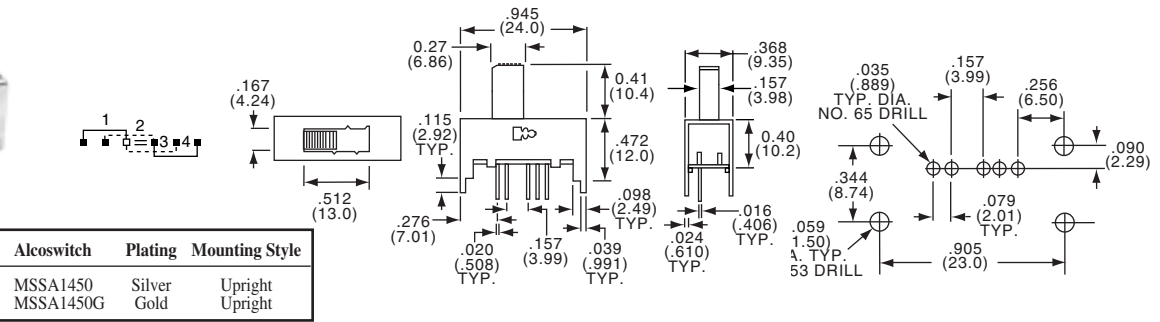

MSSA1450

Tyco Electronics	Alcoswitch	Plating	Mounting Style
3-1437580-7	MSSA1450	Silver	Upright
3-1437580-8	MSSA1450G	Gold	Upright

**SP4T**

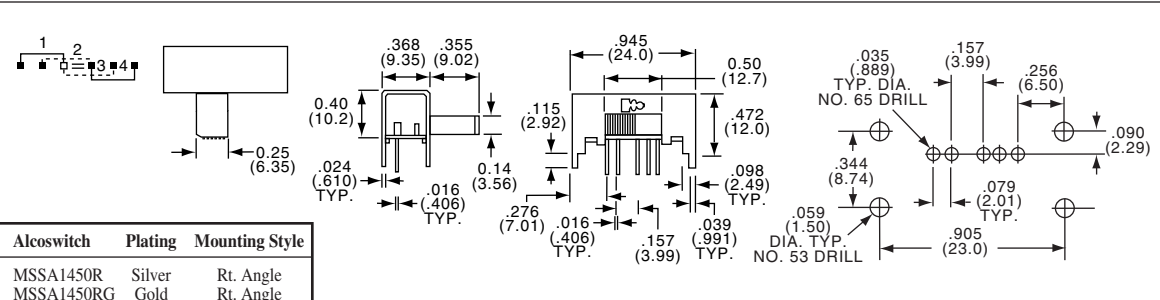

MSSA1450R

Tyco Electronics	Alcoswitch	Plating	Mounting Style
3-1437580-9	MSSA1450R	Silver	Rt. Angle
4-1437580-0	MSSA1450RG	Gold	Rt. Angle

B26

Catalog 1308390  
 Issued 9-04

www.tycoelectronics.com

Dimensions are in inches and millimeters unless otherwise specified. Values in parentheses or brackets are metric equivalents.

Dimensions are shown for reference purposes only. Specifications subject to change.

USA: 1-800-522-6752  
 Canada: 1-905-470-4425  
 Mexico: 01-800-733-8926  
 C. America: 52-55-5-729-0425

South America: 55-11-3611-1514  
 Hong Kong: 852-2735-1628  
 Japan: 81-44-844-8013  
 UK: 44-141-810-8967

**Slide Switches, Instrumentation Grade**

SEE PAGE B26 FOR PRODUCT SPECIFICATIONS

DP3T

MSSA2350

Dimensions: .167 (4.24), .428 (10.9), .079 (2.01) TYP., .276 (7.01), .115 (2.92), .945 (24.0), .027 (6.86), .472 (12.0), .138 (3.51), .098 (2.49) TYP., .020 (.508) TYP., .157 (3.99), .039 (.991) TYP., .368 (9.35), .157 (3.99), .040 (10.2), .016 (.406) TYP., .024 (.610) TYP., .165 (4.19), .035 (.889) TYP. DIA. NO. 65 DRILL, .157 (3.99), .090 (2.29), .335 (8.51), .344 (8.74), .059 (1.50) TYP. DIA. NO. 53 DRILL, .079 (2.01) TYP., .165 (4.19), .905 (23.0)

Tyco Electronics	Alcoswitch	Plating	Mounting Style
5-1437580-3	MSSA2350	Silver	Upright
5-1437580-4	MSSA2350G	Gold	Upright

DP3T

MSSA2350R

Dimensions: 0.25 (6.35), .276 (7.01), .079 (2.01) TYP., .115 (2.92), .945 (24.0), .421 (10.7), .472 (12.0), .138 (3.51), .098 (2.49) TYP., .020 (.508) TYP., .157 (3.99), .039 (.991) TYP., .368 (9.35), .355 (9.02), .014 (3.56), .024 (.610) TYP., .016 (.406) TYP., .035 (.889) TYP. DIA. NO. 65 DRILL, .157 (3.99), .090 (2.29), .335 (8.51), .344 (8.74), .059 (1.50) TYP. DIA. NO. 53 DRILL, .079 (2.01) TYP., .165 (4.19), .905 (23.0)

Tyco Electronics	Alcoswitch	Plating	Mounting Style
5-1437580-5	MSSA2350R	Silver	Rt. Angle
5-1437580-6	MSSA2350RG	Gold	Rt. Angle

DP4T

MSSA2450

Dimensions: .368 (9.35), .167 (4.24), .512 (13.0), .270 (6.86), .945 (24.0), .410 (10.4), .472 (12.0), .115 (2.92), .020 (.50) TYP., .039 (1.00) TYP., .157 (3.99), .016 (.41) TYP., .368 (9.35), .355 (9.02), .014 (3.56), .024 (.610) TYP., .016 (.406) TYP., .035 (.889) TYP. DIA. NO. 65 DRILL, .157 (3.99), .090 (2.29), .256 (6.50), .344 (8.48), .059 (1.50) TYP. DIA. NO. 53 DRILL, .079 (2.01) TYP., .165 (4.19), .905 (23.0)

Tyco Electronics	Alcoswitch	Plating	Mounting Style
5-1437580-7	MSSA2450	Silver	Upright
5-1437580-8	MSSA2450G	Gold	Upright

DP4T

MSSA2450R

Dimensions: 0.25 (6.35), .115 (2.92), .945 (24.0), .050 (12.7), .472 (12.0), .138 (3.51), .098 (2.49) TYP., .016 (.406) TYP., .276 (7.01), .157 (3.99), .039 (.991) TYP., .368 (9.35), .355 (9.02), .014 (3.56), .024 (.610) TYP., .016 (.406) TYP., .035 (.889) TYP. DIA. NO. 65 DRILL, .157 (3.99), .090 (2.29), .256 (6.50), .344 (8.74), .059 (1.50) TYP. DIA. NO. 53 DRILL, .079 (2.01) TYP., .165 (4.19), .905 (23.0)

Tyco Electronics	Alcoswitch	Plating	Mounting Style
5-1437580-9	MSSA2450R	Silver	Rt. Angle
6-1437580-0	MSSA2450RG	Gold	Rt. Angle

**Slide Switches, Instrumentation Grade**

SEE PAGE B26 FOR PRODUCT SPECIFICATIONS

3P3T



MSSA3350

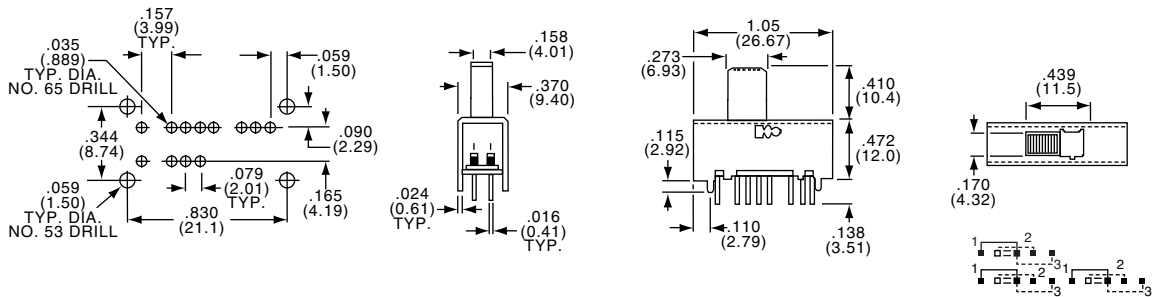

Tyco Electronics	Alcoswitch	Plating	Mounting Style
6-1437580-1	MSSA3350	Silver	Upright
6-1437580-2	MSSA3350G	Gold	Upright

3P3T



MSSA3350R

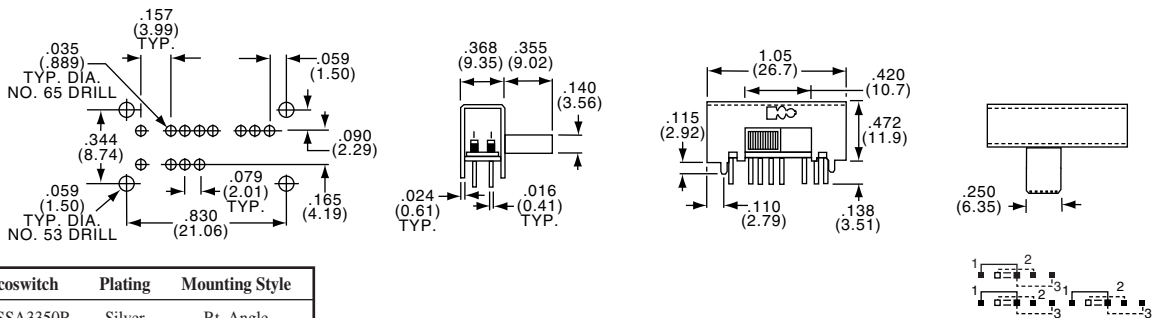

Tyco Electronics	Alcoswitch	Plating	Mounting Style
6-1437580-3	MSSA3350R	Silver	Rt. Angle
6-1437580-4	MSSA3350RG	Gold	Rt. Angle

3P4T



MSSA3450

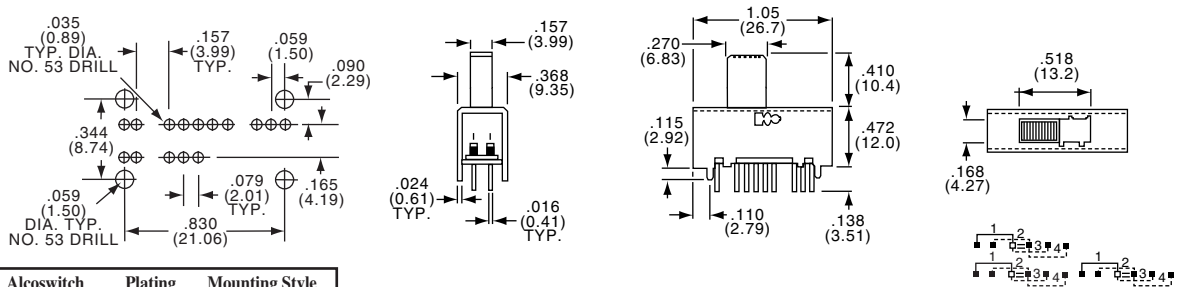

Tyco Electronics	Alcoswitch	Plating	Mounting Style
6-1437580-5	MSSA3450	Silver	Upright
6-1437580-6	MSSA3450G	Gold	Upright

3P4T



MSSA3450R

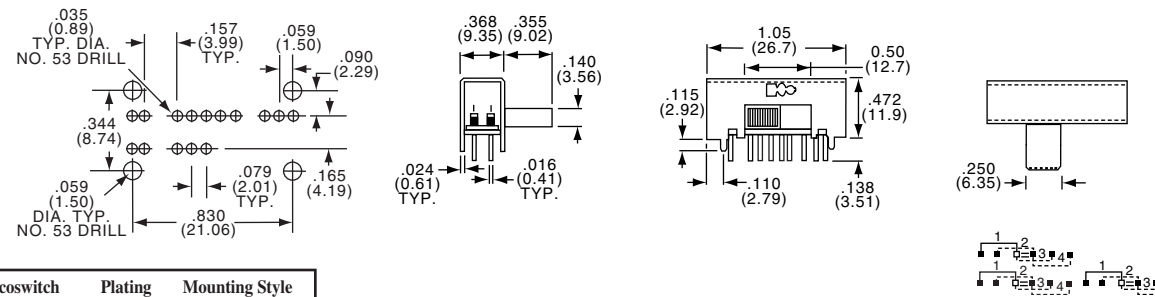

Tyco Electronics	Alcoswitch	Plating	Mounting Style
6-1437580-7	MSSA3450R	Silver	Rt. Angle
6-1437580-8	MSSA3450RG	Gold	Rt. Angle

B28

Catalog 1308390  
Issued 9-04

www.tycoelectronics.com

Dimensions are in inches and millimeters unless otherwise specified. Values in parentheses or brackets are metric equivalents.

Dimensions are shown for reference purposes only. Specifications subject to change.

USA: 1-800-522-6752  
Canada: 1-905-470-4425  
Mexico: 01-800-733-8926  
C. America: 52-55-5-729-0425

South America: 55-11-3611-1514  
Hong Kong: 852-2735-1628  
Japan: 81-44-844-8013  
UK: 44-141-810-8967

**Slide Switches, Instrumentation Grade**

SEE PAGE B26 FOR PRODUCT SPECIFICATIONS

4P3T

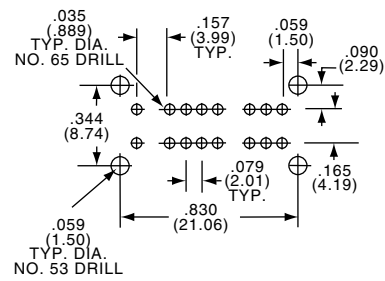
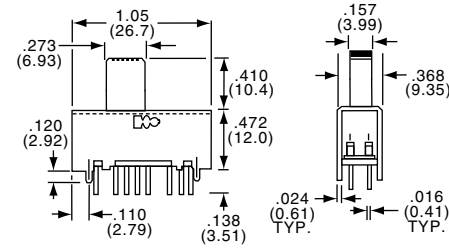
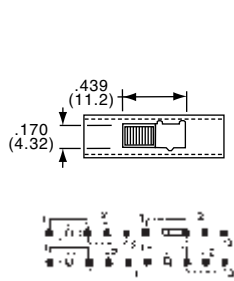

MSSA4350

Tyco Electronics	Alcoswitch	Plating	Mounting Style
6-1437580-9	MSSA4350	Silver	Upright
7-1437580-0	MSSA4350G	Gold	Upright

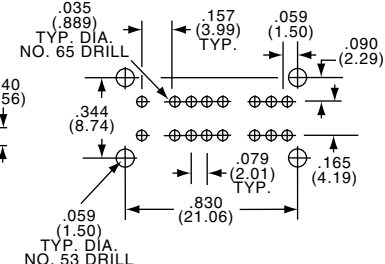
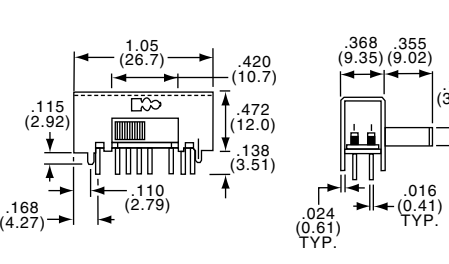
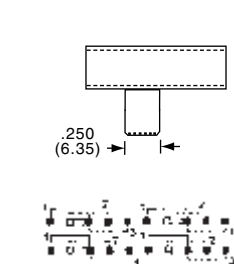

MSSA4350R

Tyco Electronics	Alcoswitch	Plating	Mounting Style
7-1437580-1	MSSA4350R	Silver	Rt. Angle
7-1437580-2	MSSA4350RG	Gold	Rt. Angle

4P3T

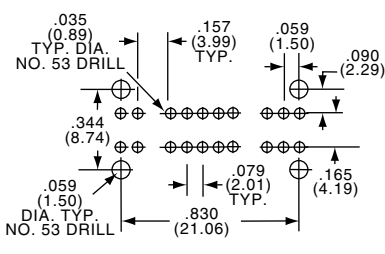
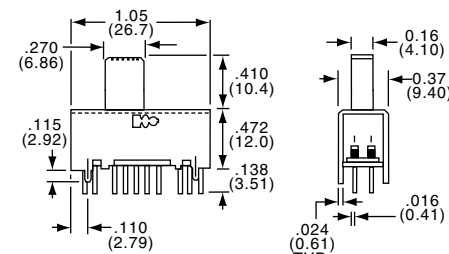
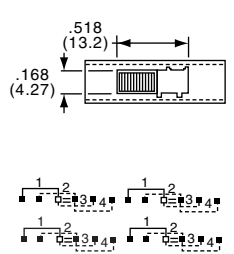

MSSA4450

Tyco Electronics	Alcoswitch	Plating	Mounting Style
7-1437580-3	MSSA4450	Silver	Upright
7-1437580-4	MSSA4450G	Gold	Upright

4P4T

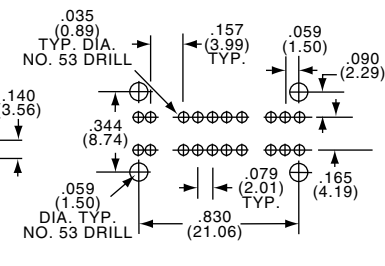
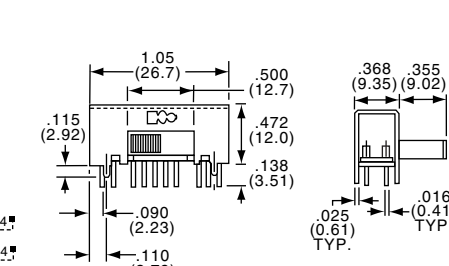
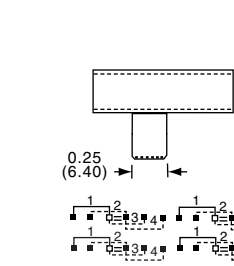

MSSA4450R

Tyco Electronics	Alcoswitch	Plating	Mounting Style
7-1437580-5	MSSA4450R	Silver	Rt. Angle
7-1437580-6	MSSA4450RG	Gold	Rt. Angle

4P4T

**Slide Switches, Instrumentation Grade, .200 Terminal Spacing**

**MATERIAL SPECIFICATIONS:**

Contacts .....Silver clad or gold plate  
 Case Material .....Polyester  
 Actuator Material .....Polyamide  
 Terminals .....Gold or silver plate  
 Terminal Seal .....Epoxy

**ENVIRONMENTAL SPECIFICATIONS:**

Operating Temperature.....-4°F to +149°F (-20°C to +65°C)  
 Storage Temperature.....-40°F to +212°F (-40°C to +100°C)  
 Solder Heat Resistance.....See page M3-4

**TYPICAL PERFORMANCE CHARACTERISTICS:**

Contact Rating .....Gold: 0.4 VA max. 20 VDC or peak AC  
 Silver: 3 A @ 115 VAC, 1.5A @ 230 VAC  
 Initial Contact Resistance .....20 Milliohms max.  
 Contact Timing .....Non-shorting  
 Insulation Resistance .....1,000 Megohms @ 500 VDC min.  
 Dielectric Strength .....500 Volts RMS @ sea level  
 Actuation Force .....600 ±300 Grams  
 Actuator Travel......120" (3.05) Approximate  
 Life Expectancy .....Up to 30,000 Cycles

**SPDT**



MSSA114D

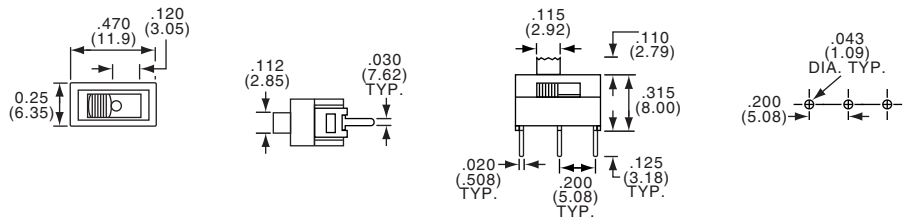

Tyco Electronics	Alcoswitch	Act. Code	Pg. M5				Contacts
2-1437580-9	MSSA111DG	D	On	None	On	Gold	
3-1437580-0	MSSA111EG	E	On	Off	On	Gold	
3-1437580-1	MSSA114D	D	On	None	On	Silver	
3-1437580-2	MSSA114E	E	On	Off	On	Silver	

**DPDT**



MSSA214N

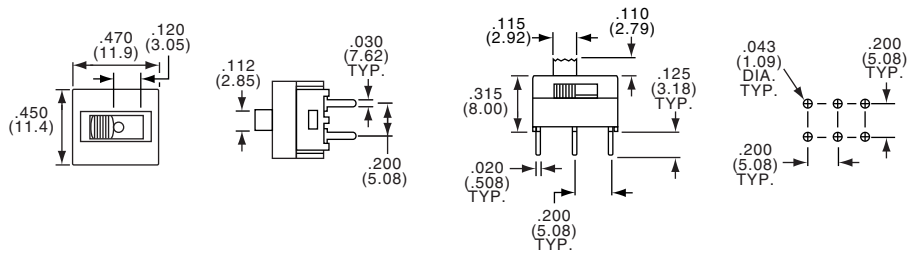

Tyco Electronics	Alcoswitch	Act. Code	Pg. M5				Contacts
4-1437580-9	MSSA211NG	N	On	None	On	Gold	
5-1437580-2	MSSA214N	N	On	None	On	Silver	