

HFE1600-S1U RACK INSTRUCTION MANUAL

HFE1600-S1U SERIES RACK SPECIFICATIONS

1	Number of power supply modules (*3) (*7)	---	Maximum 5 units HFE1600 of the same output voltage rating
2	Maximum output power	W	Refer to HFE1600 specifications
3	Maximum output current	---	266A per output (Total 532A)
4	Input voltage / frequency range (*1)	---	85~265Vac continuous, 47~63Hz, Single phase, separate input for each PS module.
5	Maximum input current (at 100/200Vac)	A	14.2/8.1 for each HFE1600 power supply module
6	Maximum line regulation (*4)	%	0.25
7	Max load regulation (*5)	%	0.80
8	AC input connector (*6)	---	Separate for each power supply. HFE1600-S1U: IEC inlet (C16); HFE1600-S1U/TB: Terminal Block.
9	Output terminals	---	Two bus-bars outputs for each terminal (two sides). Refer to outline drawing.
10	Remote sensing (*2)	V	Possible. Refer to Instruction Manual.
11	Parallel operation	---	Possible. Refer to Instruction Manual.
12	Series operation	---	Possible. Refer to Instruction Manual.
13	Remote On/Off control (INHIBIT)	---	Separate control for each PS unit, by electrical signal or dry contact. "OFF": 0~0.6V or short. "ON": 2~15V or open.
14	Remote On/Off control (ENABLE)	---	Common for all PS units, by electrical signal or dry contact. "ON": 0~0.6V or short. "OFF": 2~15V or open.
15	DC OK signal	---	Separate signal for each PS unit, open collector signal. Maximum sink current: 10mA, Max 15V. Tracking output setting, "LOW" when $V_{out} > 90\% \pm 5\%$ of output voltage setting
16	AC fail signal	---	Separate signal for each PS unit, open collector signal. Maximum sink current: 10mA, Max 15V. "LOW" when input voltage $85Vac < V_{in} < 270Vac$.
17	Over Temperature alarm signal	---	Separate signal for each PS unit, open collector signal. Maximum sink current: 10mA, Max 15V Refer to Instruction Manual
18	Output voltage trimming	---	Common for all PS units, by built-in potentiometer. Refer to Instruction Manual.
19	Output voltage programming	---	Possible, Common for all PS units, by 0~5V signal. Refer to Instruction Manual.
20	Output voltage programming via I ² C interface	---	Possible, Common for all PS units. Refer to Instruction Manual.
21	Auxiliary power supply	---	11.2~12.5VDC. Maximum output current: 0.5A
22	Operating temperature	---	-10~50°C: 100% load. +50°C to +60°C: Derate 2%/°C of load +60°C to +70°C: Derate 2.5%/°C of load
23	Storage temperature	---	-30~85°C
24	Operating humidity	---	10~90% RH, no condensation.
25	Storage humidity	---	10~95% RH, no condensation.
26	Vibration	---	Built to meet IEC60068-2-64 (Basic Transportation)
27	Shock	---	Built to meet IEC60068-2-27 (Basic Transportation)
28	Applicable safety standards	---	UL60950-1, EN60950-1
29	Withstand voltage	---	Input-Output: 3000Vrms, 1min.
			Input-Ground: 2000Vrms, 1min
			Output-Ground: 12V, 24V, 32V models - 500Vrms, 1min
			Output-Ground: 48V model - 2250Vdc, 1min.
30	Insulation resistance	---	More than 100Mohm at 25°C and 70% RH. Output-Ground: 500Vdc
31	Weight (Typ) (with accessories)	kg	5.6
32	Size (W*H*D)	---	445x43.6x365mm. Refer to Outline Drawing.

Notes:

- *1 For cases where conformance to various safety standards (UL, EN etc.) is required, Input voltage to be described as 100-240Vac (50/60Hz).
- *2 Maximum voltage drop on load wires: HFE1600-12: 0.5V/wire, HFE1600-24: 0.5V/wire, HFE1600-32: 0.75V/wire, HFE1600-48: 1V/wire.
- *3 Mixing of units with PMBus option ("HFE1600-xx/S") and standard units ("HFE1600-xx") is not allowed.
- *4 From 85~132Vac or 170~265Vac, constant load.
- *5 From No-load to Rated load, constant input voltage. Measured at the sensing point in Remote sense.
- *6 Use UL approved Insulated terminals lugs
- *7 The output of all HFE1600 modules are connected in parallel in the Rack

SAFETY APPROVALS

UL 60950-1 and CSA22.2 No.60950-1 - UL Recognized. C-UL for Canada.

IEC 60950-1 - CB Report and Certificate.

EN 60950-1 - CE mark.

Marking by the CE Symbol indicates compliance to the Low Voltage Directive of the European Union.

A "Declaration of Conformity" in accordance with the preceding directives and standards has been made and is on file at our EU representative: TDK-Lambda Germany GmbH, Karl-Bold-Str. 40, D-77855 Achern.

A "Declaration of Conformity" may be accessed via company website www.emea.tdk-lambda.com/manual

All Models of HFE and RFE series are professional equipment and are not intended for sale to the general public.

SAFETY INSTRUCTIONS

CAUTION: The following safety precaution must be observed during all phases of operation, service and repair of this equipment. Failure to comply with the safety precautions or warnings in this document violates safety standards of design, manufacture and intended use of this equipment and may impair the built-in protections within. TDK Lambda shall not be liable for user's failure to comply with these requirements.

CAUTION: HFE1600-S1U rack is not authorized for use as critical component in nuclear control systems, life support systems or equipment for use in hazardous environments without the express written approval of the managing director of TDK-Lambda.

INSTALLATION (OVERVOLTAGE) CATEGORY & ENVIRONMENTAL CONDITIONS

The HFE1600-S1U has been evaluated to Overvoltage category II.

The HFE1600-S1U intended for use in the following operation conditions:

- * Indoor use
- * Pollution degree 2
- * Max. operational altitude: 3000m above sea level
- * Ambient temperature: -10°C-50°C at 100% load, up to 70°C with output de-rating applied (refer to Specification above).

GROUNDING

HFE1600-S1U rack is Class I product. To minimize shock hazard, the HFE1600-S1U rack must be connected to an electrical ground. The instruments must be connected to the AC power supply mains through a three conductor power cable, with the ground wire firmly connected to an electrical ground (safety ground) at the power outlet. For instruments designed to be hard-wired to the supply mains, the protective earth terminal must be connected to the safety electrical ground before any other connection is made. Any interruption of the protective ground conductor or disconnection of the protective earth terminal will cause a potential shock hazard that might cause personal injury.

LIVE CIRCUITS

Operating personnel must not remove the HFE1600-S1U rack cover.

No internal adjustment or component replacement is allowed by non-TDK Lambda qualified service personnel. Never replace components with power cable connected. To avoid injuries, always disconnect power, discharge circuits and remove external voltage sources before touching components.

Restricted Access Area: HFE1600-S1U rack should only be installed in a Restricted Access Area. Access should be available to service personnel only.

PARTS SUBSTITUTIONS & MODIFICATIONS

Parts substitutions and modifications are allowed by authorized TDK Lambda service personnel only. For repairs or modifications, the instrument must be returned to TDK Lambda service facility.

AC INPUT, AC INPUT RATING, AC POWER CABLES

CAUTION
Risk of electrical shock and energy hazard. Disconnecting one power supply line disconnects only one power supply module. To isolate the unit completely, disconnect all power supply lines. Terminal blocks should only be used by professional workers to connect AC cables.

ATTENTION
Risque de choc et de danger é'lectriques. Le de'branchement d'une seule alimentation stabilise'e ne de'branche uniquement qu'un module "Alimentation Stabilise'e". Pour isoler completement le module en cause, il faut de'brancher toutes les alimentations stabilise'es.

ACHTUNG
Spannungsführende Teile - Gefahr durch elektrischen Schlag oder hohe Energieinhalte. Alle Netzstecker der einzelnen Komponenten bzw. der Einschübe müssen getrennt werden, damit das System "spannungsfrei" ist. Die Eingangsklemme der Stromversorgung ist nur innerhalb eines Gesamtsystemes zu verwenden.

Do not connect HFE1600-S1U to mains supply exceeding the input voltage and frequency rating of HFE1600-S1U. The input voltage and frequency rating is: 100-240V~, 50/60Hz. For safety reasons, the mains supply voltage fluctuations should not exceed +/-10% of nominal voltage.

AC Cables are not provided with unit. Refer to table below for recommended AC cables.

HFE1600- S1U	HFE1600- S1U/TB
Standard high temprature power cable with type C15 appliance plug rated: EU - 10A/250V; US/C - 15A/250V	Min. - 14AWG (1.5 mm ²), rated Min. 300Vac, 105°C for supply and ground connection.
	Terminal Lug - Use UL approved Insulated terminal lugs.

HEAT HAZARD

WARNING: Top, bottom and side surfaces may become hot when operating the unit continuously. To reduce the risk of injury from a hot surface, allow the surface to cool before touching.

ENERGY HAZARD

The main output of HFE1600-S1U is capable of providing hazardous energy. Due to hazardous energy level the output bus bars and connections therefore must not be user accessible. Manufacturer's final equipment must provide protection to service personnel against inadvertent contact with output bus bars.

OVERCURRENT PROTECTION:

A readily accessible branch circuit over current protective device rated 30A max. per each input must be incorporated in the building wiring. The protective device must disconnect both supply line simultaneously.

FUSES

There are no fuses in the HFE1600-S1U rack.

SYMBOLS



CAUTION Risk of Electrical Shock.



Instruction manual symbol. The instrument will be marked with this symbol when it is necessary for the user to refer to the instruction manual.



Indicates hazardous voltage.



This symbol indicates the presence of a hot surface or component. Touching this surface could result in bodily injury.



Indicates ground terminal.



Protective Ground Conductor Terminal

L1

Indicates first Line supply terminal

L2/N

Indicates second Line or Neutral supply terminal

WARNING

Denotes hazard. An attention to a procedure is called. Not following the procedure correctly could result in personal injury. A WARNING sign should not be skipped and all indicated conditions must be fully understood and met.

CAUTION

Denotes hazard. An attention to a procedure is called. Not following the procedure correctly could result in damage to the equipment.

SICHERHEITS - HINWEISE

Vorsicht

Die folgenden Sicherheitsvorschriften müssen vor Inbetriebnahme und in jedem Betriebszustand bei Service oder Reparatur beachtet werden. Missachtung der Sicherheitsvorschriften und Warnhinweise aus diesem Handbuch führen zur Verletzung der bestehenden Sicherheitsstandards. Bei Betrieb des Gerätes ausserhalb dem bestimmungsgemässen Einsatz können die im Gerät integrierten Schutzfunktionen beeinträchtigt werden. TDK-Lambda ist nicht haftbar für Schäden, die durch Missachtung dieser Sicherheitsvorschriften entstehen können.

Vorsicht

Das HFE1600-S1U-Rack ist nicht für die Verwendung als kritische Komponente in nuklearen Steuerungssystemen, lebenserhaltenden Systemen oder Geräte für den Einsatz in gefährlichen Umgebungen, ohne die ausdrückliche schriftliche Genehmigung durch TDK-Lambda zugelassen

Betriebsbedingungen und Umweltbedingungen

Das HFE1600-S1U-Rack ist zur Installation gemäss Überspannungs-Kategorie 2 evaluiert worden.

Das HFE1600-S1U-Rack ist gemäss den Sicherheitsabnahmen für folgende Betriebsbedingungen bestimmt.

* Stationäre Einrichtungen in Gebäuden.

* Verschmutzungsgrad 2.

* Erlaubte Betriebshöhe: bis zu 3000m.

* Umgebungstemperaturbereich: -10 bis +50° C, bis zu 70°C mit Derating (Details entnehmen Sie bitte dem Datenblatt)

Erdungskonzept

Dieses Produkt ist ein Gerät der Schutzklasse 1. Zur Vermeidung von gefährlichen Energieinhalten und Spannungen, ist das Gehäuse an eine Schutz Erde anzuschliessen. Der PE-Anschluss ist an einen festen Erder anzuschliessen. Bei Festverdrahtung des Gerätes ist sicherzustellen, dass der PE Anschluss als erstes angeklemt wird. Jede mögliche Unterbrechung des PE-Leiters oder Trennung der PE Verbindung kann einen möglichen elektrischen Schlag hervorrufen, der Personenschäden zur Folge hätte.

Spannungsführende Teile

Die Geräteabdeckung darf nicht durch Endanwender geöffnet werden. Interne Modifikationen, sowie Bauteilaustausch ist nur durch TDK-Lambda qualifiziertes Personal erlaubt. Vor Austausch von Bauteilen ist das Netzkabel bzw. die Versorgungsspannung zu trennen. Energieversorgungsanschlüsse sind immer zu trennen, um Personenschäden durch gefährliche Energieinhalte und Spannungen auszuschliessen. Die Stromkreise sind zu entladen, externe Spannungsquellen sind zu entfernen, bevor auf Bauteile bzw. Komponenten Ebene gearbeitet wird.

Änderungen und Bauteilersatz

Ersatzteilaustausch - und Änderungen dürfen nur von autorisiertem TDK-Lambda SERVICE-PERSONAL durchgeführt werden. Für Reparaturen oder Änderungen ist das Gerät zur TDK-Lambda Service-Niederlassung zu retournieren.

Anschluss an Versorgungsstromkreis

Der Betrieb des HFE1600-S1U ist nur für den dafür spezifizierten Wechselspannungsbereich und der angegebenen Frequenz erlaubt. Die Eingangsspannung und Frequenz ist: 100-240V ~ bei 50/60Hz. Aus Gründen der Sicherheit sollten die Netzspannungsschwankungen im Bereich von + / -10% der Nennspannung liegen.

Heisse Oberflächen

WARNUNG: Im Dauerbetrieb erwärmen sich die Gehäuseoberflächen. Um das Verletzungs-Risiko durch heisse Oberflächen zu minimieren, sollte das Gerät einige Zeit abkühlen können, bevor weitere Arbeiten durchgeführt werden.

Gefährlicher Energieinhalt

Der Hauptausgang des HFE1600-S1U liefert gefährlich hohe Energieinhalte. Aufgrund der gefährlichen Energieinhalte müssen die Stromschienen und die Ausgangsanschlüsse abgedeckt sein und dürfen für den Benutzer nicht zugänglich sein. Der Endgeräte Lieferant hat für die Berührungssicherheit der Ausgänge und Stromschienen Sorge zu tragen.

Überstromschutz

Eine leicht zugängliche Vorsicherung mit 30A max.. pro Eingang muss in der Hausinstallation vorgesehen werden

SICHERUNGEN

Das HFE1600 S1U-Rack selbst verfügt über keine Absicherung

Sicherheits- und Warnsymbole



VORSICHT Spannungsführende Teile-Gefahr durch elektrischen Schlag bzw. Energieinhalte.



Handbuch-Symbol. Das Gerät bzw. Geräteteile werden mit diesem Symbol gekennzeichnet, wenn es für den Benutzer notwendig ist, sich auf die Anweisungen im Handbuch zu beziehen.



Zeigt "spannungsführende Teile" mit gefährlicher Spannung an.



Dieses Symbol weist auf das Vorhandensein einer heißen Oberfläche oder Komponente. Das Berühren dieser Oberfläche kann zu Verletzungen führen.



Zeigt Masse-Anschluss an, keine Schutzerde. (z.B .Masseanschluss an einen Verbraucher).



Schutzleiter-Anschlussklemme.

WARNUNG

Dieser Warnhinweis beschreibt Gefahren, deren Nichteinhaltung zu Personenschäden führen können. Die Warnhinweise müssen daher zwingend wie im Handbuch beschrieben in der Applikation eingehalten werden.

ACHTUNG

Diese Sicherheitsinformation weist auf Gefahren im täglichen Umgang mit dem Gerät hin, deren Missachtung zu Fehlfunktionen oder Defekten in der Applikation führen können. Bitte lesen Sie diese Sicherheitsinformationen , bevor Sie das Gerät einbauen oder in Betrieb nehmen.

1. REAR PANEL CONNECTIONS AND CONTROLS

Fig 1.1 Rear view of HFE1600-S1U series

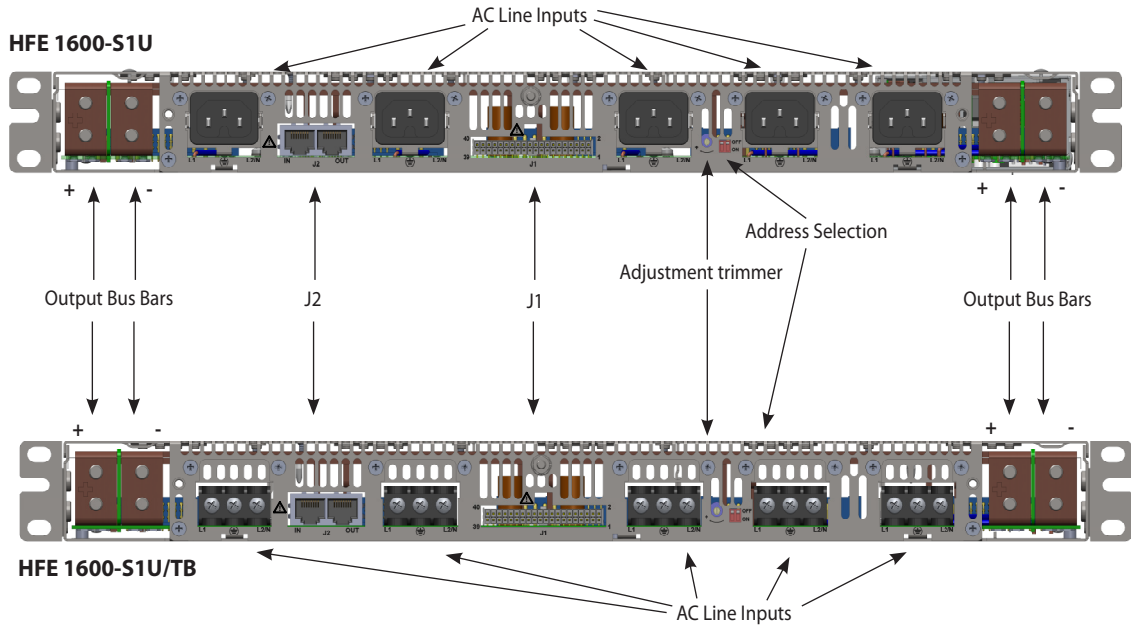

1.1. J1 Connector for Control and Monitoring

Mating for J1 Control Plug (provided) or custom made plug/ cable should be inserted to J1 for proper operation of HFE1600 rack. Refer to Chapter 3 for connection diagrams.

PLEASE VERIFY J1 IS PROPERLY PLUGGED IN. ENSURE THAT THERE IS NO MECHANICAL STRESS ON J1 CONNECTOR.

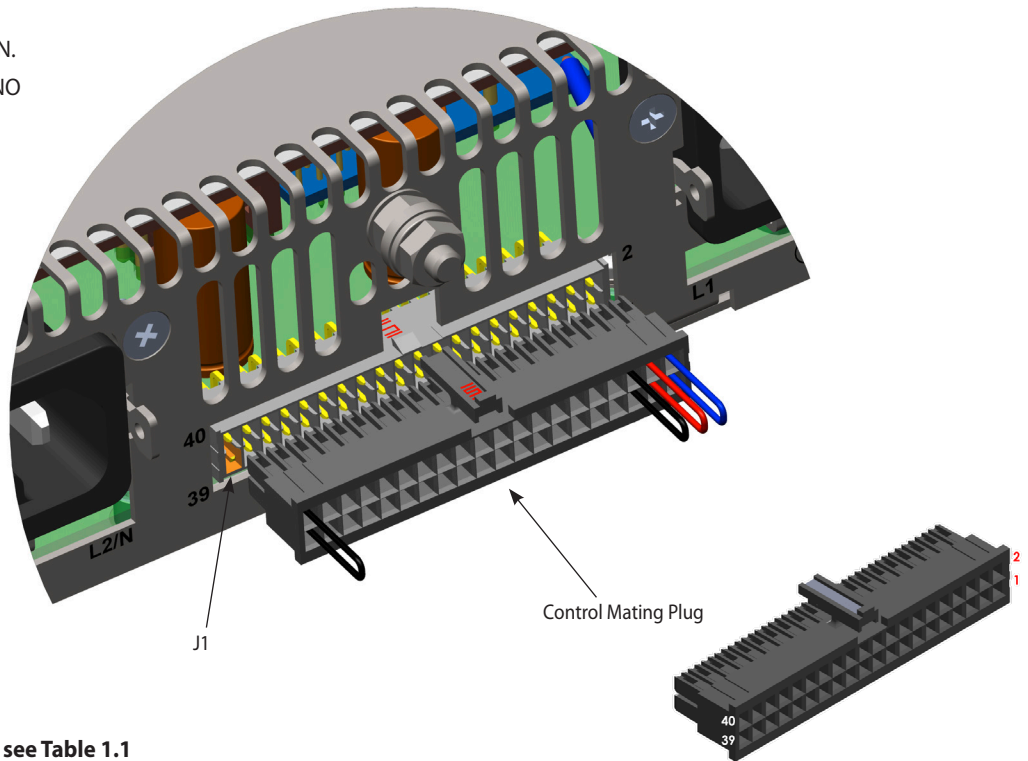

J1 Pin Allocation Chart see Table 1.1



J1 connector description: P/N: IPL1-120-01-S-D-RA-K (SAMTEC)
Mating Plug description: P/N: IPD1-20-D-K (SAMTEC)

Table 1.1 J1 Connector Pin Allocation Chart

Pin #	Name	Description	Pos. #	Control plug J1	Referenced to
1,10	-SENSE	Negative sense Connected to –LS for local sensing, or –V on Load side.	All	Short	
2	-LS	Connected to Negative Output bus bar through 3 Ohm resistor.	All		
3	+SENSE	Positive sense Connected to +LS for local sensing, or +V on Load side.	All	Short	
4	+LS	Connected to Positive Output bus bar through 3 Ohm resistor.	All		
5	V_PROG	Input (0~5V) referenced to –S. Provides Vout programming by Voltage. Refer to Fig 3.6, 3.7.	All	Short	-SENSE
6	TRIM	Output of Rear Panel potentiometer, for manual adjustment of Output Voltage.	All		-SENSE
7	NOT USED				
8,9	+5V/V_REF	5V fix output for standard option unit. V_REF for Voltage programming when PMBus option is being used. Refer to Instruction Manual Chapter 3.	All		-SENSE
11	TEMP_ALM_A	Output signal of PS in position A. "LOW" when the internal temperature is within safe limit, "HIGH" approximately 10°C below Thermal shut down. Open collector (15V max, sink current 10mA max).	A		SIGNAL RETURN
12	TEMP_ALM_B	Output signal of PS in position B. Same as 11.	B		SIGNAL RETURN
13	TEMP_ALM_C	Output signal of PS in position C. Same as 11.	C		SIGNAL RETURN
14	TEMP_ALM_D	Output signal of PS in position D. Same as 11.	D		SIGNAL RETURN
15	TEMP_ALM_E	Output signal of PS in position E. Same as 11.	E		SIGNAL RETURN
16	AC_FAIL_A	Output signal of PS in position A. "LOW" when the input voltage is 85Vac<Vin<270Vac, "HIGH" when the input voltage is 85Vac>Vin or Vin>270Vac. Open collector (15V max, sink current 10mA max).	A		SIGNAL RETURN
17	AC_FAIL_B	Output signal of PS in position B. Same as 16.	B		SIGNAL RETURN
18	AC_FAIL_C	Output signal of PS in position C. Same as 16.	C		SIGNAL RETURN
19	AC_FAIL_D	Output signal of PS in position D. Same as 16.	D		SIGNAL RETURN
20	AC_FAIL_E	Output signal of PS in position E. Same as 16.	E		SIGNAL RETURN
21	DC_OK_A	Output signal of PS in position A. "LOW" when the output voltage is higher than 85~95% of Vout setting. Open collector (15V max, sink current 10mA max).	A		SIGNAL RETURN
22	DC_OK_B	Output signal of PS in position B. Same as 21.	B		SIGNAL RETURN
23	DC_OK_C	Output signal of PS in position C. Same as 21.	C		SIGNAL RETURN
24	DC_OK_D	Output signal of PS in position D. Same as 21.	D		SIGNAL RETURN
25	DC_OK_E	Output signal of PS in position E. Same as 21.	E		SIGNAL RETURN
26 37 40	SIGNAL RETURN	Reference for: ENABLE, INHIBIT, TEMP ALARM, AC FAIL, DC OK, +12V AUX, SCL, SDA, SMB ALERT. The SIGNAL RETURN is isolated from the output.	All		
27	INHIBIT_A	Input for PS in position A. Turns OFF the Main Output by electrical signal or dry contact. "SHORT" or 0~0.6V – Output OFF. "OPEN" or 2~15V – Output ON.	A		SIGNAL RETURN
28	INHIBIT_B	Input signal for PS in position B. Same as 27.	B		SIGNAL RETURN
29	INHIBIT_C	Input signal for PS in position C. Same as 27.	C		SIGNAL RETURN
30	INHIBIT_D	Input signal for PS in position D. Same as 27.	D		SIGNAL RETURN
31	INHIBIT_E	Input signal for PS in position E. Same as 27.	E		SIGNAL RETURN
32	PS_EXIST_A	Output signal of PS in position A. SHORT to Signal Return when PS is inserted into the Rack.	A		SIGNAL RETURN
33	PS_EXIST_B	Output signal of PS in position B. Same as 32.	B		SIGNAL RETURN
34	PS_EXIST_C	Output signal of PS in position C. Same as 32.	C		SIGNAL RETURN
35	PS_EXIST_D	Output signal of PS in position D. Same as 32.	D		SIGNAL RETURN
36	PS_EXIST_E	Output signal of PS in position E. Same as 32.	E		SIGNAL RETURN
38	+12V_AUX	Output. Auxiliary supply 11.2~12.5VDC. Not affected by any signal or fail state.			SIGNAL RETURN
39	ENABLE	Input for entire rack. Turns ON the Main Output by electrical signal or dry contact. "SHORT" or 0~0.6V – Output ON. "OPEN" or 2~15V – Output OFF.	All	Short	SIGNAL RETURN

1.2. J2 Pin Allocation Chart

J2 connector (RJ45 type) is used for parallel connection of two Racks.

Table 1.2

IN		OUT	
Pin #	Name	Pin #	Name
1	CURRENT SHARE	1	CURRENT SHARE
2	I_PROG	2	I_PROG
3	V_PROG	3	V_PROG
4	-SENSE	4	-SENSE
5	SCL (PMBus)	5	SCL (PMBus)
6	SIGNAL_RETURN	6	SIGNAL_RETURN
7	SDA (PMBus)	7	SDA (PMBus)
8	SMB_ALERT	8	SMB_ALERT

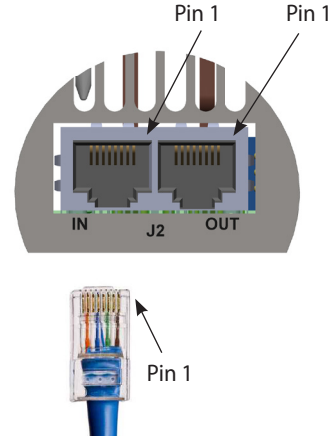

1.3. Output Bus Bar Connections

The HFE1600-S1U has two identical Output Bus Bar connections on both sides of Rear Panel. They are connected in parallel in the Rack.

Each or both of them can be used for output connections.

ATTENTION: Maximum allowable current for each pair of Output Bus Bars – 266A. Total Output Current: 532A

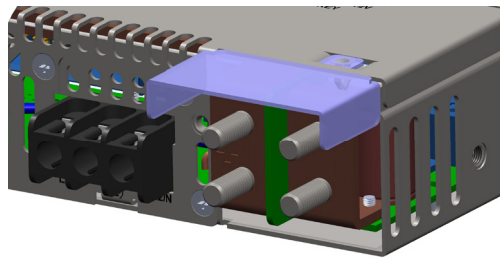
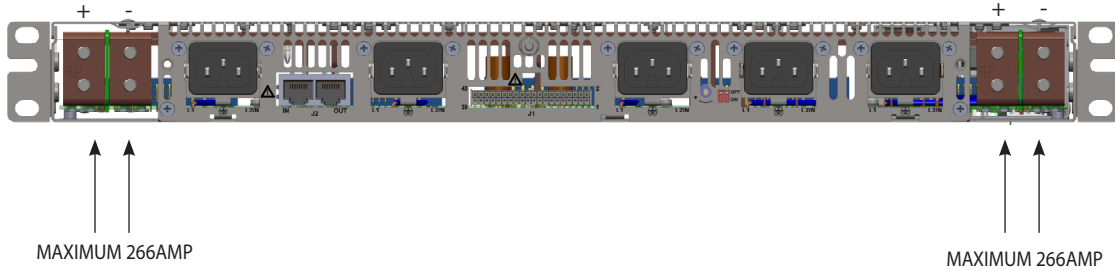

Fig 1.3a Output Bus-Bars.

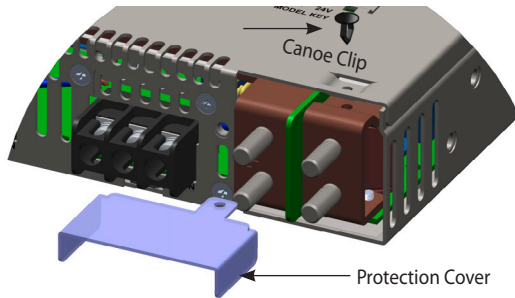

Fig 1.3b Installation of Output Bus-Bars Protection Cover.

1.4. Output Voltage adjustment Trimmer

Output Voltage may be adjusted by the Rear Panel Trimmer.

Model	HFE1600-12	HFE1600-24	HFE1600-32	HFE1600-48
Output voltage range (V)	9.6~13.2	19.2~29.0	25.6~38.4	38.4~58



*NOTE - Manual Trim Setup is not to be used with /S PMBus versions. See section 3.7 - Setup Output Voltage Programming by PMBus

1.5. PMBus address

Each slot in the Rack (see fig-2.2) has its own address for PMBus communication. Valid only if /S option power supply is being used. In case parallel connection of two racks is used, SW1 located at the rear panel is used to differentiate between addresses for the same slots. see Table below.

Position In Rack	SW1-1	SW1-2	Address (Bin)
A	ON	ON	0010000
B			0010001
C			0010010
D			0010011
E			0010100
A	OFF	OFF	0011000
B			0011001
C			0011010
D			0011011
E			0011100

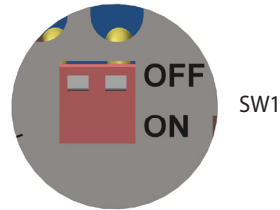

2. RACK MECHANICAL FEATURES

2.1. Insertion and extraction of the PS

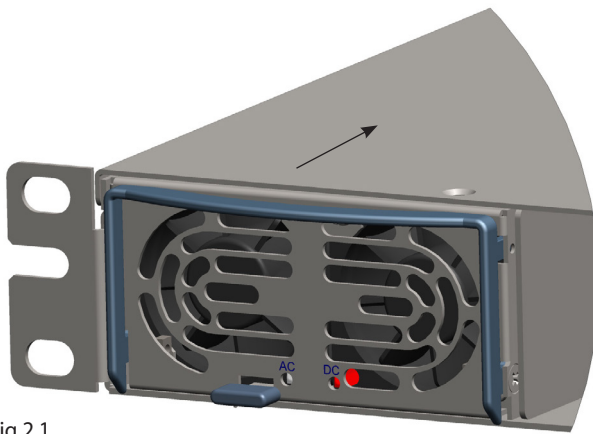
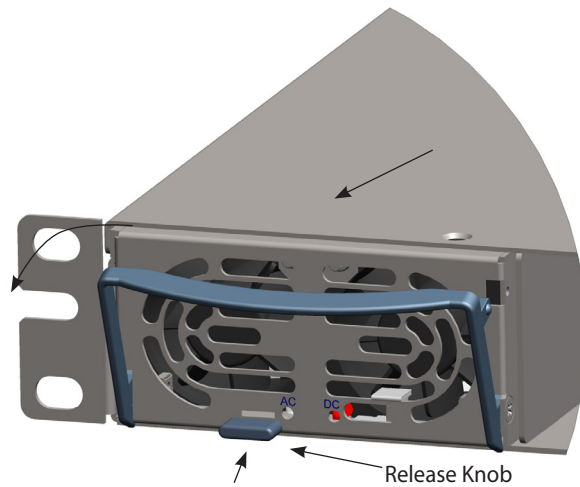

Fig 2.1

To insert the power supply, push unit into the rack with extraction handle closed.



To extract power supply, elevate the release knob and pull the extraction handle simultaneously.

CAUTION

When inserting a power supply into the rack, do not use unnecessary force; slamming the power supply into the rack can damage the connectors on the rear of the supply and inside the rack.

2.2. Definition of Power Supplies Position

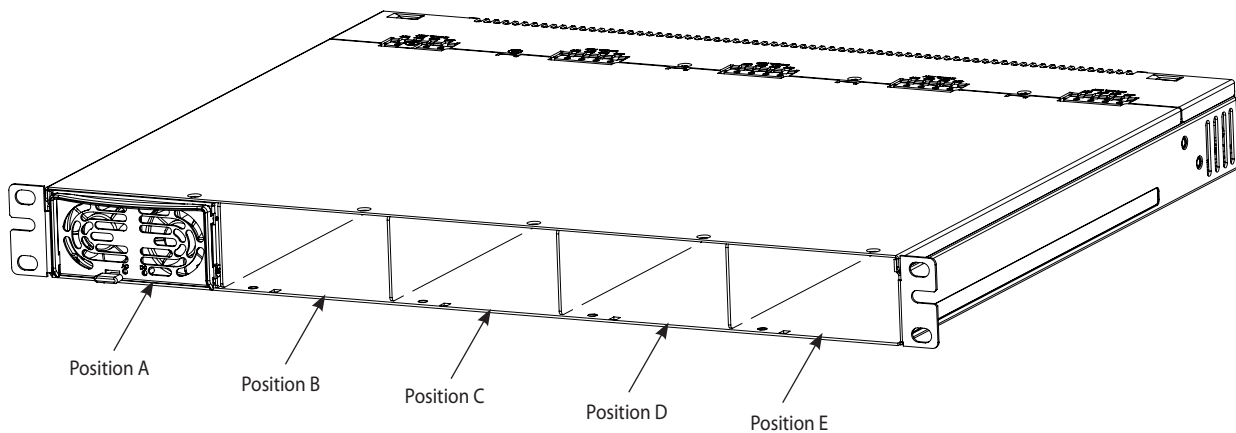

Fig 2.2 Power supply positions

2.3 Keying Option to define the Rack's Voltage

Keying Option can be installed to ensure that only the correct Power Supply can be inserted into the Rack. The Key Option consists of two parts: Power Supply Key (one per unit Fig 2.3a) and Rack Keys (5 per Rack Fig 2.3b). Power Supply Key and Rack Keys should be fixed (by Flat head screws M3x6) in position corresponding to Output Voltage.

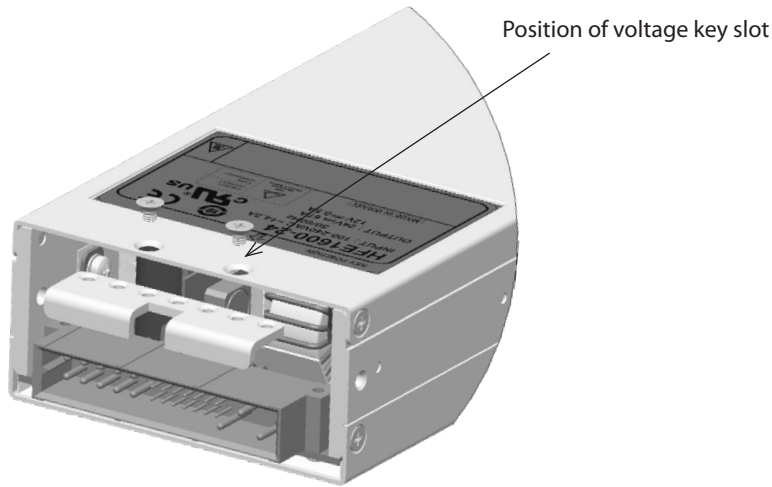

Fig 2.3a
Assembly of voltage key

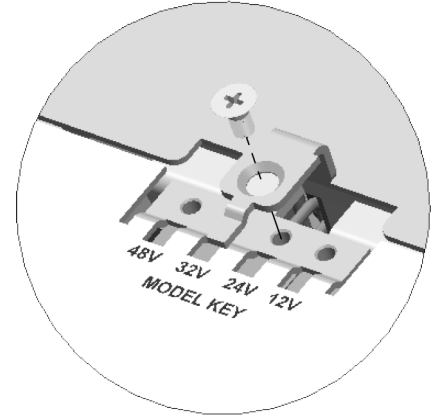

Fig 2.3b
Assembly of Rack Key (Rack Top View)

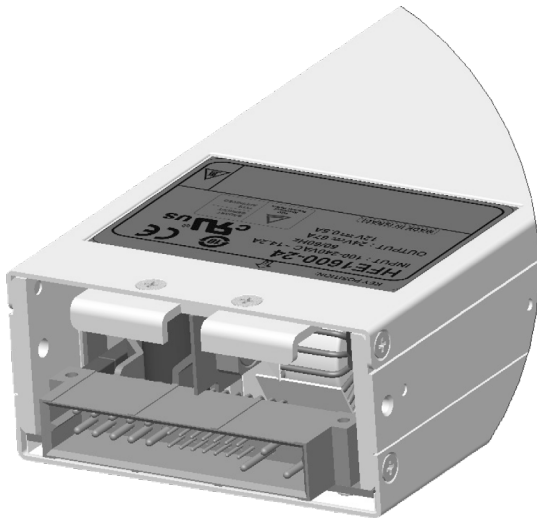

Fig 2.3c
Example 24V Model with assembled Key.

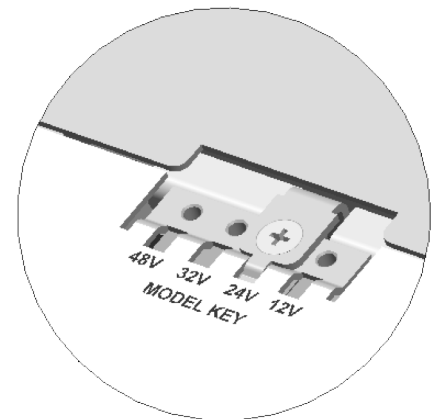

Fig 2.3d
Example Rack Key assembled for 24V power supplies

2.4 Blank Panel

In case all positions of the Rack are not filled with supplies, Blank Panel should be used to ensure proper Air Flow. It is recommended to interleave supplies and Blank Panels wherever possible.

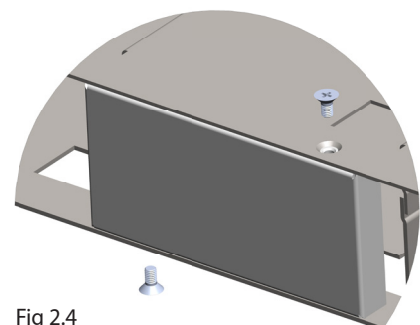

Fig 2.4
Blank Panel mounting

2.5 Rack mounting options

Rack can be mounted into 19" Rack Cabinet which suits both USA and European Standards:

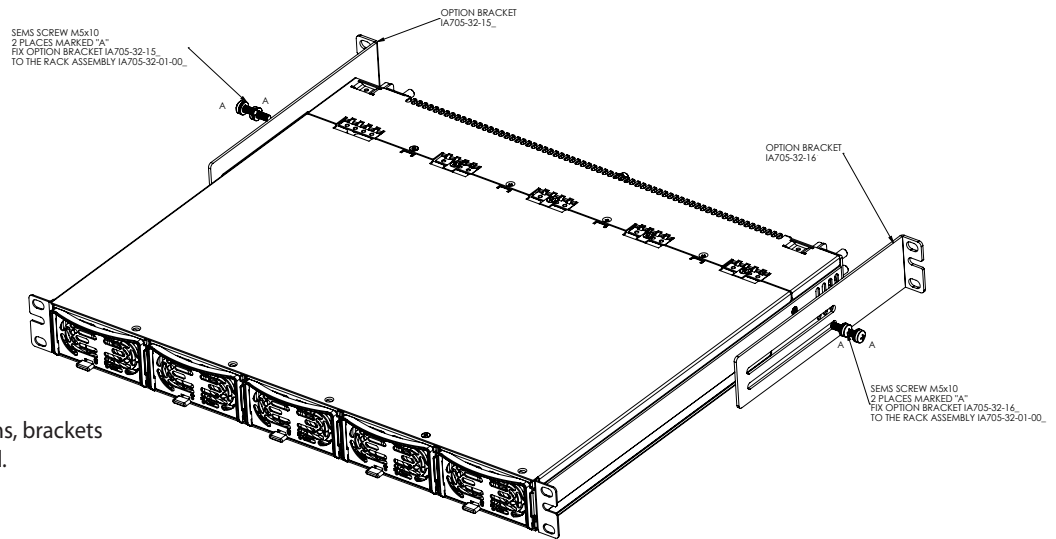
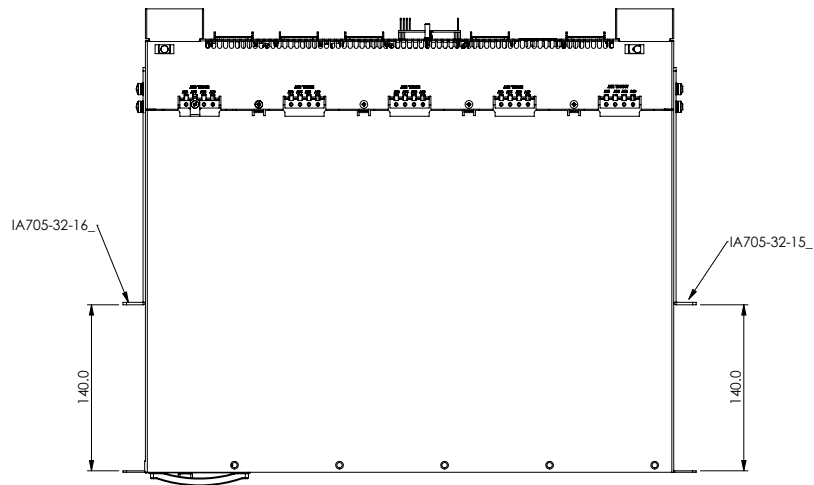
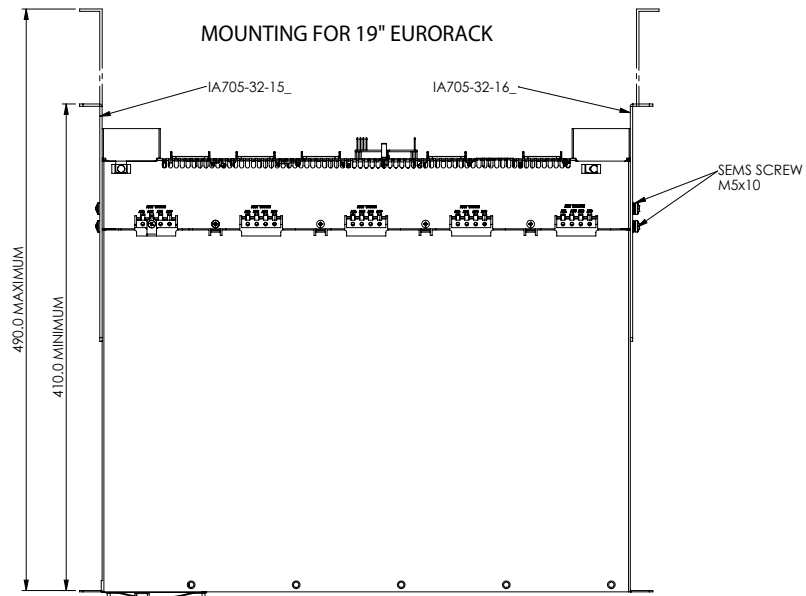

Fig 2.5 Mounting options, brackets and screws are included.

MOUNTING FOR 19" USA RACK



MOUNTING FOR 19" EURORACK



3. TYPICAL APPLICATIONS

3.1 Basic connection

For basic connection, the supplied Control Plug should be inserted to J1.

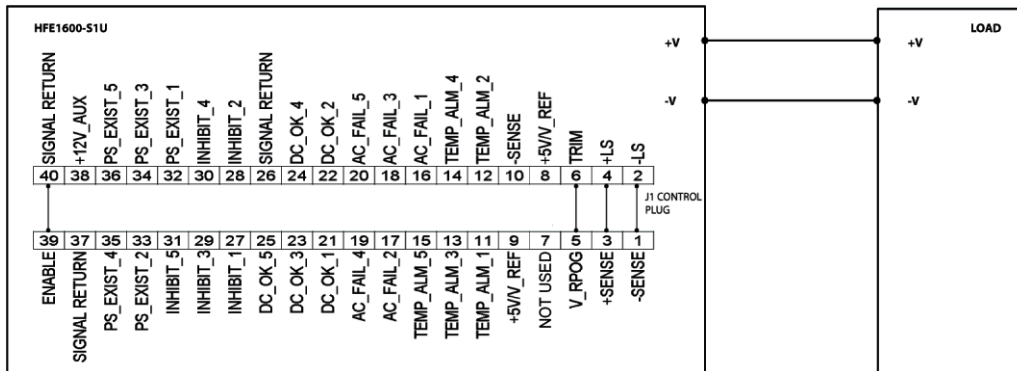

Fig 3.1 Basic connection diagram.

3.2 Remote sensing

ATTENTION:

1. Maximum voltage drop on load wires: HFE1600-12: 0.25V/wire, HFE1600-24: 0.5V/wire, HFE1600-32: 0.75V/wire, HFE1600-48: 1V/wire.
2. Twisted wires should be used for Remote Sense connection.
3. If Remote Sensing is used, do not break Main Output connection.

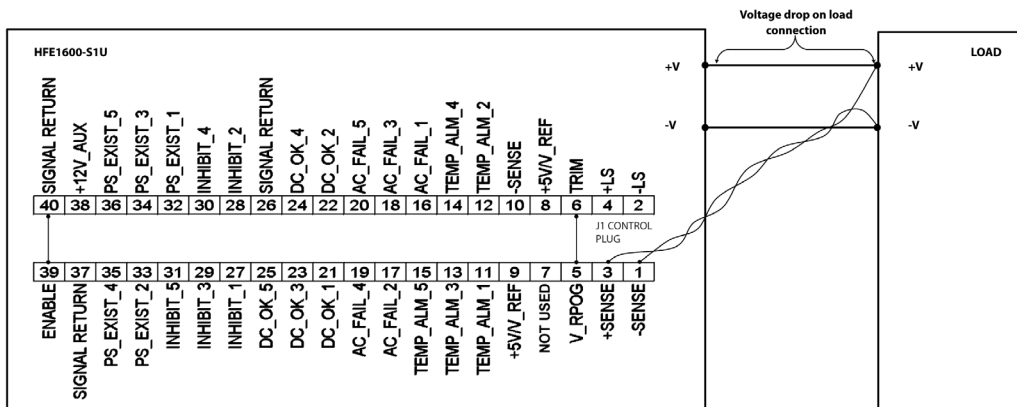

Fig 3.2 Remote Sensing connection diagram

3.3 On/Off control for the entire Rack

Switch closed: Output ON

Switch open: Output OFF

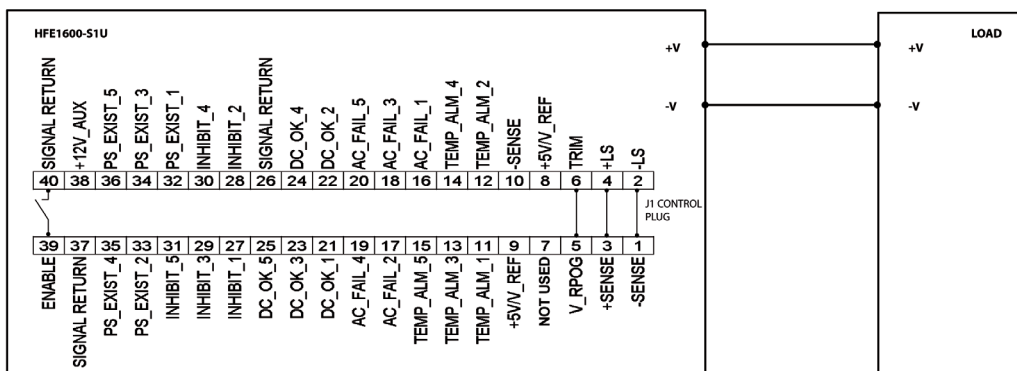

Fig 3.3 Entire rack On/Off control diagram.

3.4 Individual On/Off control for each PS

Switch closed: Output OFF
Switch open: Output ON

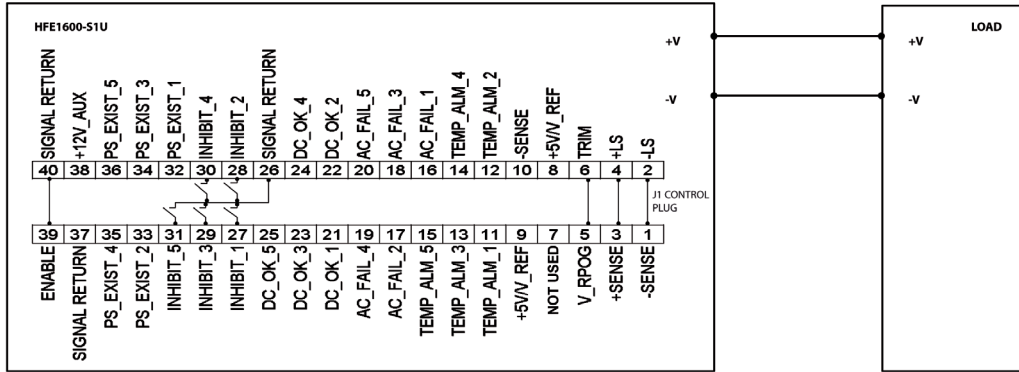

Fig 3.4 individual units On/Off diagram.

3.5 Supervisory signals.

Following signals are accessible from each power supply at J1:

- DC OK
- AC FAIL
- PS EXIST
- TEMP ALARM

These signals are Open Collector type (max 15V, max 10mA), isolated from Output and referenced to SIGNAL RETURN.

Fig 3.5 presents example of the typical connection for DC OK signal of power supply in position E.

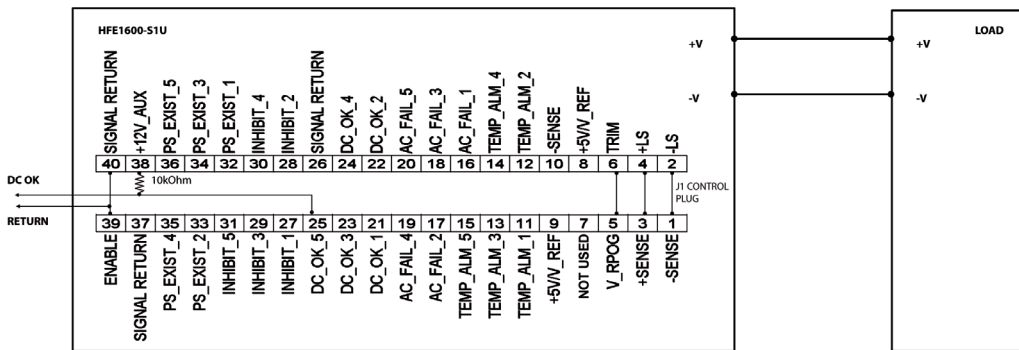

Fig 3.5 "DC OK" signal connection diagram for Power Supply in Position E.

3.6 Output Voltage programming by External Voltage.

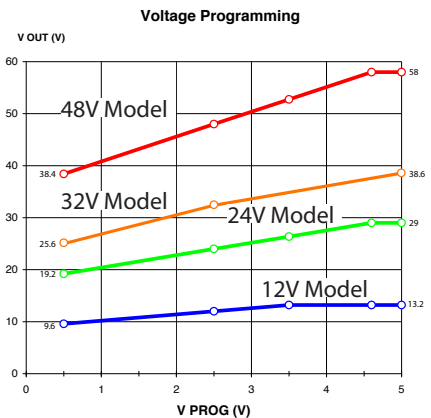
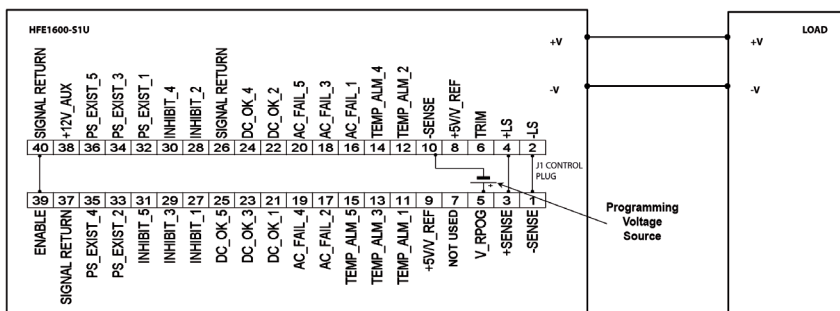

Fig 3.6 Output Voltage programming by External Voltage.

3.7 Output Voltage programming by PMBus.

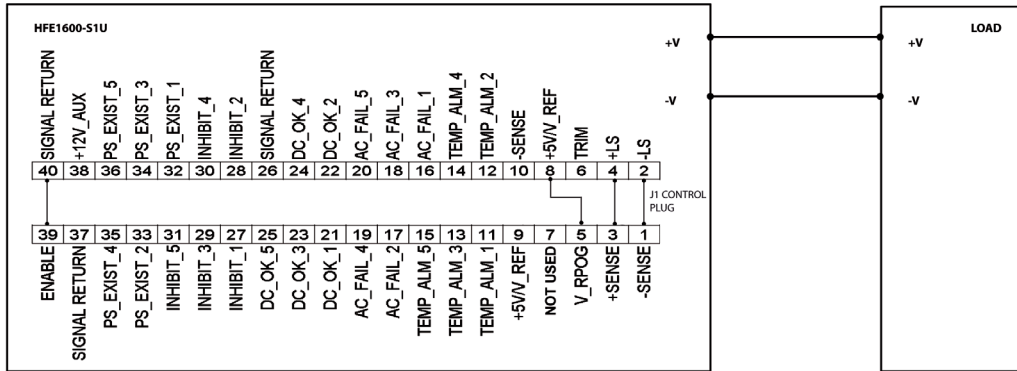

Fig 3.7 Output Voltage programming by PMBus

3.8 PMBus Host connection

To connect the rack to the Host computer, connect communication cable (refer to table 3.8 for cable connection) between J2 and computer:

Table 3.8 PMBus Cable.

Signal Name	From pin	Wire (AWG)	To Host	Note
SCL	5	22~24	-	Twisted pair
SIGNAL_RETURN	6	22~24	-	
SDA	7	22~24	-	Twisted pair
SMB_ALERT	8	22~24	-	

RJ45 Shielded Male Connector should be used.

Cable must be shielded; only connector shield is connected to cable shield.

3.9 Parallel connection of two Racks

To connect two Racks in parallel for higher Output Current:

- Connect Main Output (Bus-Bars) in parallel. Make the connections as short as possible and with equal length.
- Connect Sense (twisted pairs) to Load point.
- Connect J2 connector of both Racks by Cable (for cable construction see Table 3.9).
- Slave - Disconnect connection between VPROG and TRIM (J1.5 and J1.6).
- Slave - Switch SW1 to "OFF" position (applicable for HFE1600-xx /S PMBus option). For addressing refer to Table 1.5.
- Output Voltage can be adjusted by the trimmer on Master Rack.

Table 3.9 Rack Interconnection Cable.

Signal Name	From pin	Wire (AWG)	To Pin	Note
CURRENT SHARE	1	22~24	1	Twisted pair
V_PROG	3	22~24	3	Twisted pair
-SENSE	4	22~24	4	
SCL	5	22~24	5	Twisted pair
SIGNAL_RETURN	6	22~24	6	
SDA	7	22~24	7	Twisted pair
SMB_ALERT	8	22~24	8	

RJ45 Shielded Male Connectors should be used.

Cable must be shielded; only connector shields are connected to cable shield.

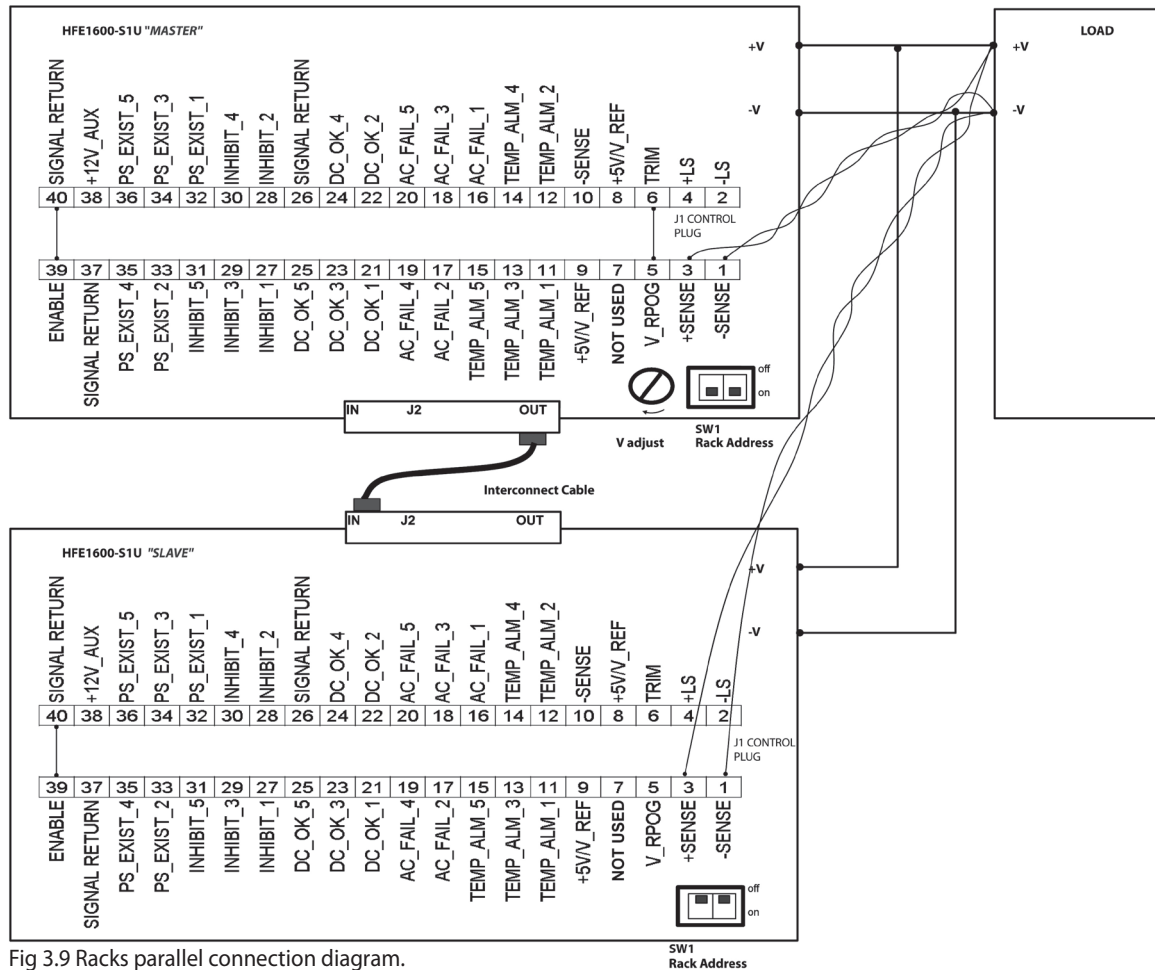

Fig 3.9 Racks parallel connection diagram.

*Note: For PMBUS OPTION in the master rack

1. Disconnect Pin 5&6
2. Connect Pin 5&8

3.10 Series Rack connection

Up to 2 racks with the same number of power supplies and rating (voltage and current) can be used to increase the output voltage.

To connect two Racks in series:

- Connect Main Output (bus bars) in series;
- Connect Sense (twisted) to Load point (as shown in fig-3.10), or use Local Sensing using supplied Control Plugs.
- In case PMBus is used, Connect J2 connector of both Racks by Interconnect Cable for Serial connection (for cable construction see Table 3.10).

CAUTION

Do not use Cable as of Table 3.9

On one Rack Switch SW1 up to OFF position (only for HFE1600-xx /S PMBus option). For Addressing see Table 1.5;

- Output Voltage can be adjusted by potentiometers on both Racks.

Table 3.10 Rack Interconnection Cable for Serial connection.

Signal Name	From pin	Wire (AWG)	To Pin	Note
CURRENT SHARE	1	Open	1	Do not connect!
V_PROG	3	Open	3	Do not connect!
-SENSE	4	Open	4	
SCL	5	22~24	5	Twisted pair
SIGNAL_RETURN	6	22~24	6	
SDA	7	22~24	7	Twisted pair
SMB_ALERT	8	22~24	8	

RJ45 Shielded Male Connectors should be used. Cable must be shielded; only connector shields are connected to cable shield. Diodes should be connected in parallel with each unit output to prevent reverse voltage. Each diode should be rated to at least the power supply rated output voltage and output current.

WARNING

Do not connect -SENSE and any signals referenced to -SENSE between two Racks. Only signals referenced to SIGNAL RETURN can be connected between Racks.

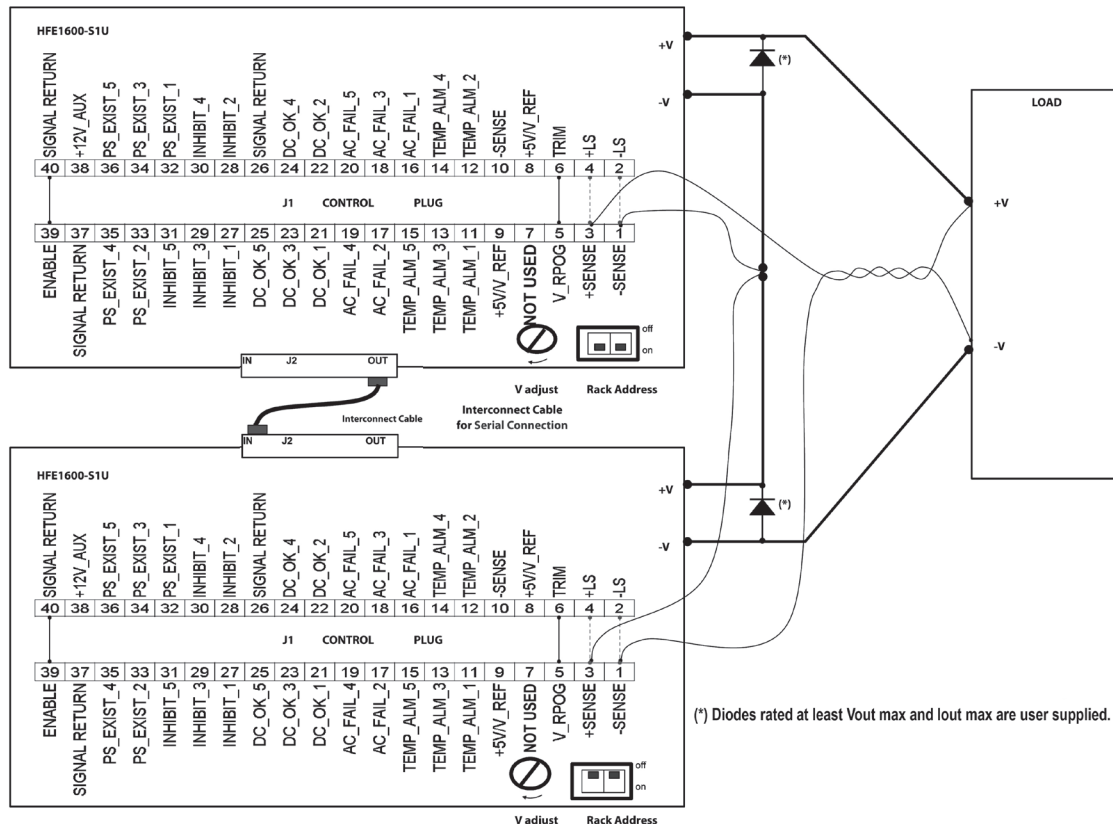
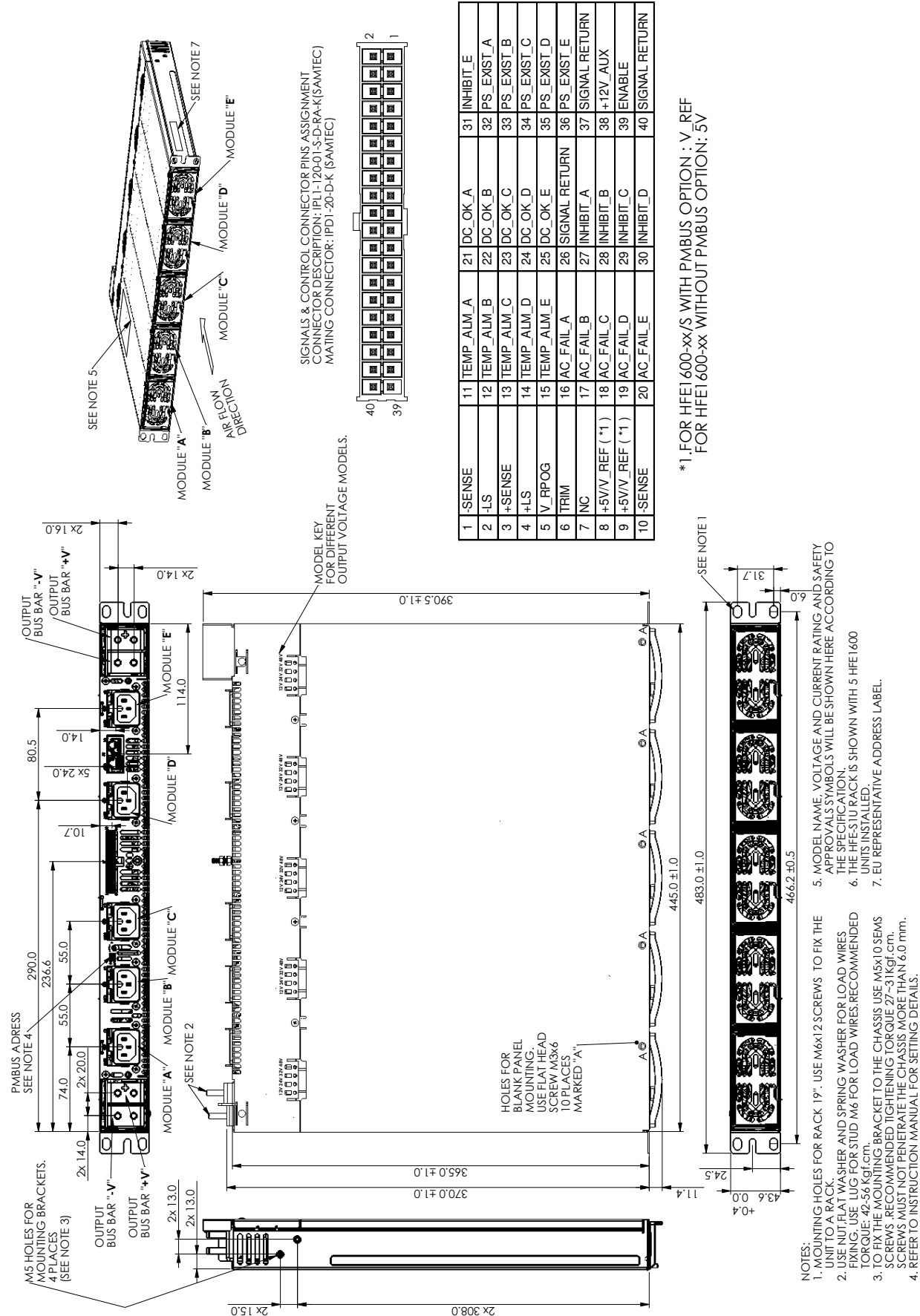
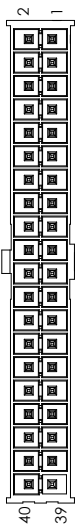

Fig 3.10 Serial connection diagram (remote sense).

HFE 1600 - S1U Outline Drawing



SIGNALS & CONTROL CONNECTOR PINS ASSIGNMENT
 CONNECTOR DESCRIPTION: IPL1-12001-S-D-RA-K (SAMTEC)
 MATING CONNECTOR: IPDI-20-D-K (SAMTEC)



1	SENSE	11	TEMP_ALM_A	21	DC_OK_A	31	INHIBIT_E
2	LS	12	TEMP_ALM_B	22	DC_OK_B	32	PS_EXIST_A
3	+SENSE	13	TEMP_ALM_C	23	DC_OK_C	33	PS_EXIST_B
4	+LS	14	TEMP_ALM_D	24	DC_OK_D	34	PS_EXIST_C
5	V RPOG	15	TEMP_ALM_E	25	DC_OK_E	35	PS_EXIST_D
6	TRIM	16	AC_FAIL_A	26	SIGNAL_RETURN	36	PS_EXIST_E
7	NC	17	AC_FAIL_B	27	INHIBIT_A	37	SIGNAL_RETURN
8	+5V/V_REF (*1)	18	AC_FAIL_C	28	INHIBIT_B	38	+12V_AUX
9	+5V/V_REF (*1)	19	AC_FAIL_D	29	INHIBIT_C	39	ENABLE
10	SENSE	20	AC_FAIL_E	30	INHIBIT_D	40	SIGNAL_RETURN

*1. FOR HFE1600-xx/S WITH PMBUS OPTION : V_REF
 FOR HFE1600-xx WITHOUT PMBUS OPTION: 5V

- NOTES:
1. MOUNTING HOLES FOR RACK 19". USE M6x12 SCREWS TO FIX THE UNIT TO A RACK.
 2. USE NUT FLAT WASHER AND SPRING WASHER FOR LOAD WIRES FIXING. USE LUG FOR STUD M6 FOR LOAD WIRES. RECOMMENDED TORQUE: 42-56 Kgf.cm.
 3. TO FIX THE MOUNTING BRACKET TO THE CHASSIS USE M5x10 SEMS SCREWS. RECOMMENDED TIGHTENING TORQUE 27-31 Kgf.cm. SCREWS MUST NOT PENETRATE THE CHASSIS MORE THAN 6.0 mm.
 4. REFER TO INSTRUCTION MANUAL FOR SETTING DETAILS.
 5. MODEL NAME, VOLTAGE AND CURRENT RATING AND SAFETY APPROVAL SYMBOLS WILL BE SHOWN HERE ACCORDING TO THE SPECIFICATION.
 6. THE HFE-S1U RACK IS SHOWN WITH 5 HFE1600 UNITS INSTALLED.
 7. EU REPRESENTATIVE ADDRESS LABEL.

HFE 1600 - S1U-TB Outline Drawing

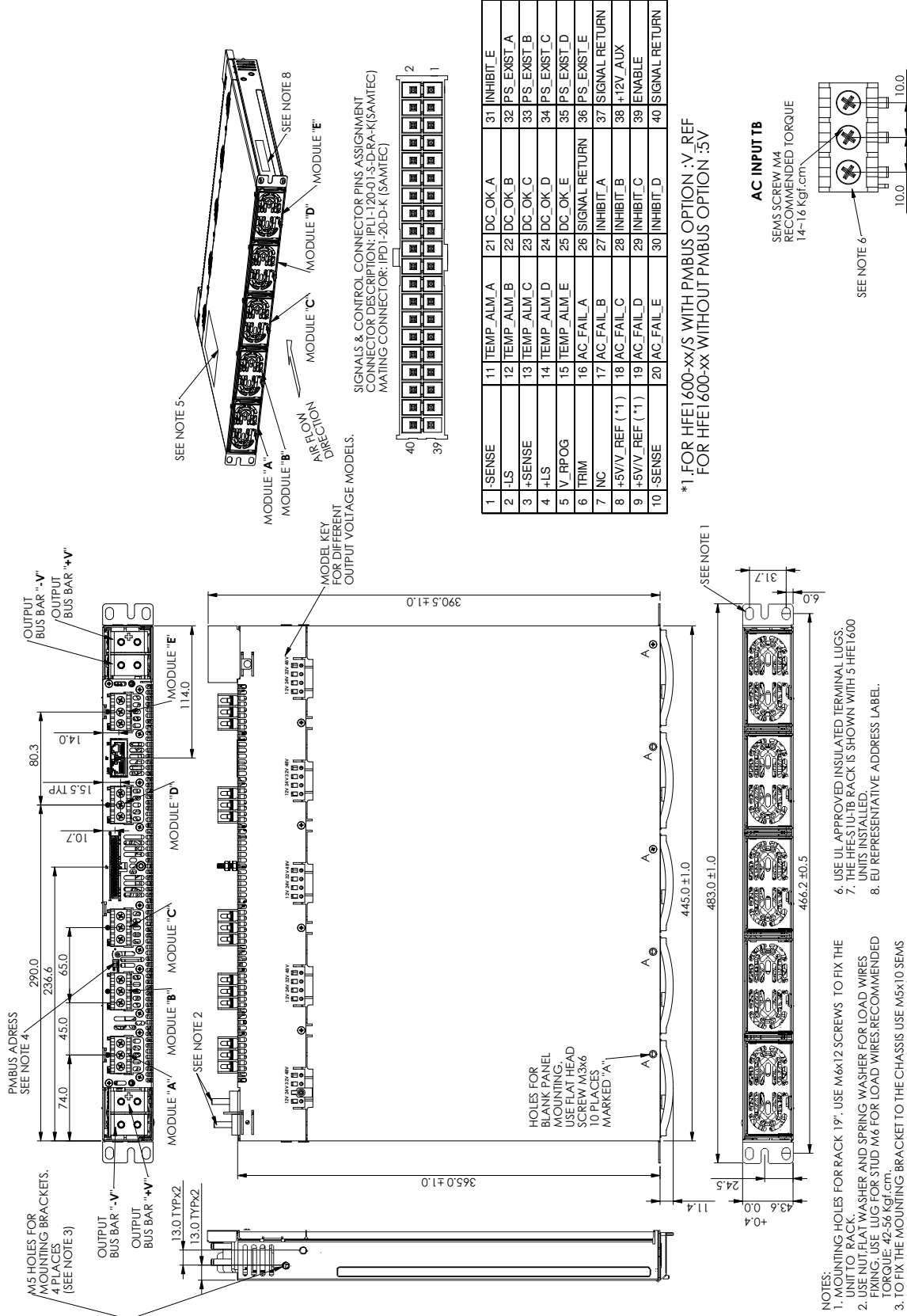

SIGNALS & CONTROL CONNECTOR PINS ASSIGNMENT
CONNECTOR DESCRIPTION: PFI-120-D1-S-DR-A-(KISAMITEC)
MATING CONNECTOR: IPD1-20-D-K (SAMITEC)

1	-SENSE	11	TEMP_ALM_A	21	DC_OK_A	31	INHIBIT_E
2	-LS	12	TEMP_ALM_B	22	DC_OK_B	32	PS_EXST_A
3	+SENSE	13	TEMP_ALM_C	23	DC_OK_C	33	PS_EXST_B
4	+LS	14	TEMP_ALM_D	24	DC_OK_D	34	PS_EXST_C
5	V_RPOG	15	TEMP_ALM_E	25	DC_OK_E	35	PS_EXST_D
6	TRIM	16	AC_FAIL_A	26	SIGNAL_RETURN	36	PS_EXST_E
7	NC	17	AC_FAIL_B	27	INHIBIT_A	37	SIGNAL_RETURN
8	+5VV_REF (*1)	18	AC_FAIL_C	28	INHIBIT_B	38	+12V_AUX
9	+5VV_REF (*1)	19	AC_FAIL_D	29	INHIBIT_C	39	ENABLE
10	-SENSE	20	AC_FAIL_E	30	INHIBIT_D	40	SIGNAL_RETURN

*1. FOR HFE1600-xx/S WITH PMBUS OPTION :V_REF
FOR HFE1600-xx WITHOUT PMBUS OPTION :5V

- NOTES:
1. MOUNTING HOLES FOR RACK 19" USE M6x12 SCREWS TO FIX THE UNIT TO RACK.
 2. USE NUT/FLAT WASHER AND SPRING WASHER FOR LOAD WIRES FIXING. USE LUG FOR STUD M6 FOR LOAD WIRES. RECOMMENDED TORQUE: 22-26 Nf.cm.
 3. TO FIX THE "A" BRACKET TO THE CHASSIS USE M5x10 SEMS SCREWS. RECOMMENDED TIGHTENING TORQUE 27-31 Nf.cm. SCREWS MUST NOT PENETRATE THE CHASSIS MORE THAN 6.0 mm.
 4. REFER TO INSTRUCTION MANUAL FOR SETTING DETAILS.
 5. MODEL NAME, VOLTAGE AND CURRENT RATING, AND SAFETY APPROVALS SYMBOLS WILL BE SHOWN HERE ACCORDING TO THE SPECIFICATION.
 6. USE UL APPROVED INSULATED TERMINAL LUGS.
 7. THE HFE1600 RACK IS SHOWN WITH 5 HFE1600 UNITS INSTALLED.
 8. EU REPRESENTATIVE ADDRESS LABEL.

