

Inductors for High-frequency Circuits

Multilayer/High-SRF

MLK series

Type:	MLK0603	0603[0201 inch]*
	MLK1005	1005[0402 inch]

* Dimensions Code JIS[EIA]

Issue date: November 2011

- All specifications are subject to change without notice.
 - Conformity to RoHS Directive: This means that, in conformity with EU Directive 2002/95/EC, lead, cadmium, mercury, hexavalent chromium, and specific bromine-based flame retardants, PBB and PBDE, have not been used, except for exempted applications.
-

Inductors for High-frequency Circuits

Multilayer/High-SRF

Conformity to RoHS Directive

MLK Series MLK0603

FEATURES

- Inductance values are supported from 1 to 33nH.
- With the adoption of a giga-spiral laminated structure, self-resonant frequency higher than that of the MLG structure can be obtained, while the decrease of Q in the GHz band is limited.
- Advanced monolithic structure is formed using a multilayering and sintering process with ceramic and conductive materials for high-frequency.
- There is no directivity.
- The products contain no lead and also support lead-free soldering.
- It is a product conforming to RoHS directive.

APPLICATIONS

For high-frequency applications including mobile phones, high frequency modules (PA, VCO, FEM etc.), Bluetooth, W-LAN, UWB and tuners.

SHAPES AND DIMENSIONS/RECOMMENDED PC BOARD PATTERN

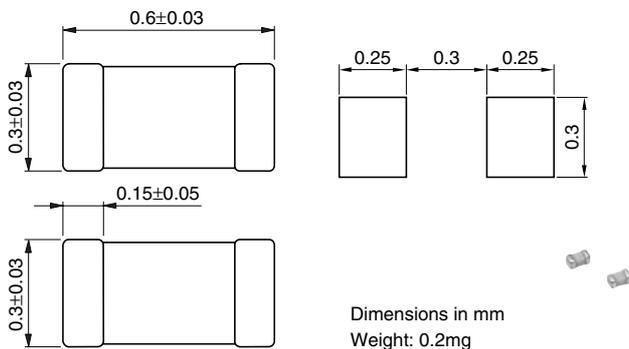

RECOMMENDED SOLDERING CONDITION

REFLOW SOLDERING

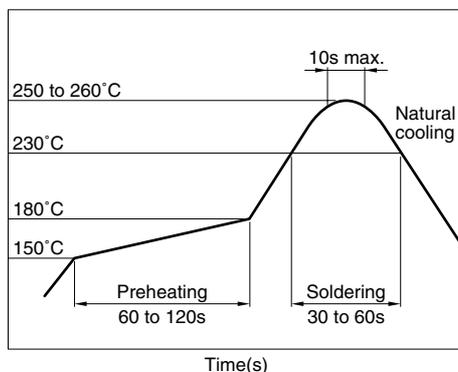

- Conformity to RoHS Directive: This means that, in conformity with EU Directive 2002/95/EC, lead, cadmium, mercury, hexavalent chromium, and specific bromine-based flame retardants, PBB and PBDE, have not been used, except for exempted applications.

- Please contact our Sales office when your application is considered the following:
The device's failure or malfunction may directly endanger human life (e.g. application for automobile/aircraft/medical/nuclear power devices, etc.)

- All specifications are subject to change without notice.

PRODUCT IDENTIFICATION

MLK	0603	L	10N	J	T	□□□
(1)	(2)	(3)	(4)	(5)	(6)	(7)

(1) Series name

(2) Dimensions L×W

0603	0.6×0.3mm (L×W)
------	-----------------

(3) Type name

(4) Inductance

2N2	2.2nH
12N	12nH

(5) Tolerance

S	±0.3nH
J	±5%

(6) Packaging style

T	Taping (reel)
---	---------------

(7) TDK internal code

SPECIFICATIONS

Operating temperature range	-55 to +125°C
Storage temperature range	-55 to +125°C(After mount)

PACKAGING STYLE AND QUANTITIES

Packaging style	Quantity
Taping	15000 pieces/reel

HANDLING AND PRECAUTIONS

- Before soldering, be sure to preheat components.
The preheating temperature should be set so that the temperature difference between the solder temperature and product temperature does not exceed 150°C.
- After mounting components onto the printed circuit board, do not apply stress through board bending or mishandling.
- When hand soldering, apply the soldering iron to the printed circuit board only. Temperature of the iron tip should not exceed 350°C. Soldering time should not exceed 3 seconds.

ELECTRICAL CHARACTERISTICS

Inductance (nH)	Inductance tolerance	Test frequency L (MHz)	Q min.	Test frequency Q (MHz)	Self-resonant frequency (GHz)		DC resistance (Ω)		Rated current (mA)max.	Part No.
					min.	typ.	max.	typ.		
1.0	± 0.3 nH	100	6	300	12.0	17.1	0.20	0.09	300	MLK0603L1N0ST
1.1	± 0.3 nH	100	6	300	11.0	17.1	0.22	0.10	300	MLK0603L1N1ST
1.2	± 0.3 nH	100	6	300	11.0	16.1	0.22	0.11	300	MLK0603L1N2ST
1.3	± 0.3 nH	100	6	300	10.0	15.8	0.24	0.12	300	MLK0603L1N3ST
1.5	± 0.3 nH	100	6	300	10.0	14.9	0.24	0.12	300	MLK0603L1N5ST
1.6	± 0.3 nH	100	6	300	10.0	14.3	0.27	0.13	300	MLK0603L1N6ST
1.8	± 0.3 nH	100	6	300	10.0	13.8	0.27	0.14	300	MLK0603L1N8ST
2.0	± 0.3 nH	100	6	300	9.0	12.6	0.30	0.15	300	MLK0603L2N0ST
2.2	± 0.3 nH	100	6	300	9.0	12.5	0.30	0.17	300	MLK0603L2N2ST
2.4	± 0.3 nH	100	6	300	8.5	11.4	0.35	0.17	300	MLK0603L2N4ST
2.7	± 0.3 nH	100	6	300	8.5	10.9	0.35	0.18	300	MLK0603L2N7ST
3.0	± 0.3 nH	100	6	300	8.0	10.6	0.40	0.20	200	MLK0603L3N0ST
3.3	± 0.3 nH	100	6	300	8.0	10.5	0.40	0.22	200	MLK0603L3N3ST
3.6	± 0.3 nH	100	6	300	8.0	9.9	0.45	0.22	200	MLK0603L3N6ST
3.9	± 0.3 nH	100	6	300	8.0	9.8	0.45	0.25	200	MLK0603L3N9ST
4.3	± 0.3 nH	100	6	300	7.5	9.5	0.50	0.28	200	MLK0603L4N3ST
4.7	± 0.3 nH	100	6	300	7.5	9.5	0.50	0.28	200	MLK0603L4N7ST
5.1	± 0.3 nH	100	6	300	6.5	8.8	0.60	0.28	200	MLK0603L5N1ST
5.6	± 0.3 nH	100	6	300	6.5	8.5	0.60	0.30	200	MLK0603L5N6ST
6.2	± 0.3 nH	100	6	300	6.0	8.3	0.65	0.34	200	MLK0603L6N2ST
6.8	$\pm 5\%$	100	6	300	6.0	8.1	0.65	0.34	200	MLK0603L6N8JT
7.5	$\pm 5\%$	100	6	300	6.0	7.7	0.70	0.36	200	MLK0603L7N5JT
8.2	$\pm 5\%$	100	6	300	6.0	7.9	0.70	0.41	200	MLK0603L8N2JT
9.1	$\pm 5\%$	100	6	300	5.5	7.4	0.80	0.42	200	MLK0603L9N1JT
10	$\pm 5\%$	100	6	300	5.5	7.5	0.80	0.48	200	MLK0603L10NJT
12	$\pm 5\%$	100	6	300	5.0	6.9	1.00	0.54	150	MLK0603L12NJT
15	$\pm 5\%$	100	6	300	4.5	6.6	1.10	0.66	150	MLK0603L15NJT
18	$\pm 5\%$	100	6	300	4.0	5.8	1.30	0.85	100	MLK0603L18NJT
22	$\pm 5\%$	100	6	300	3.5	5.3	1.60	1.02	100	MLK0603L22NJT
27	$\pm 5\%$	100	6	300	3.0	4.6	1.70	1.09	100	MLK0603L27NJT
33	$\pm 5\%$	100	6	300	2.8	4.4	1.80	1.21	100	MLK0603L33NJT

• Test equipment

Inductance Q : HP4291A+16197A, or equivalent

SRF: HP8720C, or equivalent

Rdc: YOKOGAWA TYPE7561, or equivalent

L, Q vs. FREQUENCY CHARACTERISTICS

Part No.	Inductance(nH)typ.					Q typ.				
	500MHz	800MHz	1.8GHz	2.0GHz	2.4GHz	500MHz	800MHz	1.8GHz	2.0GHz	2.4GHz
MLK0603L1N0ST	0.9	0.9	0.9	0.9	0.9	10	12	19	20	22
MLK0603L1N1ST	1.0	1.0	0.9	0.9	0.9	9	11	17	18	20
MLK0603L1N2ST	1.1	1.0	1.0	1.0	1.0	9	12	18	19	21
MLK0603L1N3ST	1.2	1.1	1.1	1.1	1.1	9	12	18	19	21
MLK0603L1N5ST	1.3	1.3	1.3	1.3	1.3	9	12	18	19	21
MLK0603L1N6ST	1.4	1.4	1.4	1.4	1.4	9	12	18	19	21
MLK0603L1N8ST	1.6	1.6	1.6	1.6	1.6	9	11	17	18	20
MLK0603L2N0ST	1.8	1.7	1.7	1.7	1.7	9	12	17	18	20
MLK0603L2N2ST	2.0	1.9	1.9	1.9	2.0	10	12	19	20	22
MLK0603L2N4ST	2.1	2.1	2.1	2.1	2.1	9	12	18	19	20
MLK0603L2N7ST	2.4	2.4	2.4	2.4	2.4	10	13	19	20	22
MLK0603L3N0ST	2.7	2.6	2.6	2.6	2.7	9	12	18	19	21
MLK0603L3N3ST	3.0	2.9	2.9	3.0	3.0	10	13	19	20	22
MLK0603L3N6ST	3.2	3.1	3.1	3.1	3.2	9	11	17	18	19
MLK0603L3N9ST	3.5	3.4	3.5	3.5	3.5	10	13	19	20	22
MLK0603L4N3ST	3.8	3.8	3.8	3.8	3.9	10	12	18	19	20
MLK0603L4N7ST	4.2	4.2	4.2	4.2	4.3	10	13	19	20	22
MLK0603L5N1ST	4.6	4.5	4.5	4.6	4.7	10	12	18	19	21
MLK0603L5N6ST	5.0	5.0	5.0	5.0	5.1	10	12	18	19	21
MLK0603L6N2ST	5.5	5.5	5.5	5.6	5.7	10	12	18	19	20
MLK0603L6N8JT	6.2	6.1	6.2	6.2	6.4	10	13	19	20	22
MLK0603L7N5JT	6.7	6.6	6.7	6.8	7.0	10	12	18	19	20
MLK0603L8N2JT	7.4	7.3	7.5	7.6	7.8	10	13	19	20	21
MLK0603L9N1JT	8.2	8.1	8.3	8.4	8.6	10	12	18	18	20
MLK0603L10NJT	9.0	8.9	9.2	9.3	9.6	10	13	18	19	20
MLK0603L12NJT	10.8	10.6	11.0	11.2	11.6	10	12	18	18	20
MLK0603L15NJT	13.5	13.4	13.9	14.2	14.8	10	12	17	18	19
MLK0603L18NJT	16.2	16.1	17.0	17.4	18.4	10	12	16	17	18
MLK0603L22NJT	19.8	19.7	20.9	21.5	22.8	10	12	16	16	17
MLK0603L27NJT	24.4	24.4	27.2	28.6	31.7	10	12	15	15	14
MLK0603L33NJT	29.7	29.7	33.4	35.1	39.3	9	11	14	14	13

• All specifications are subject to change without notice.

TYPICAL ELECTRICAL CHARACTERISTICS INDUCTANCE vs. FREQUENCY CHARACTERISTICS

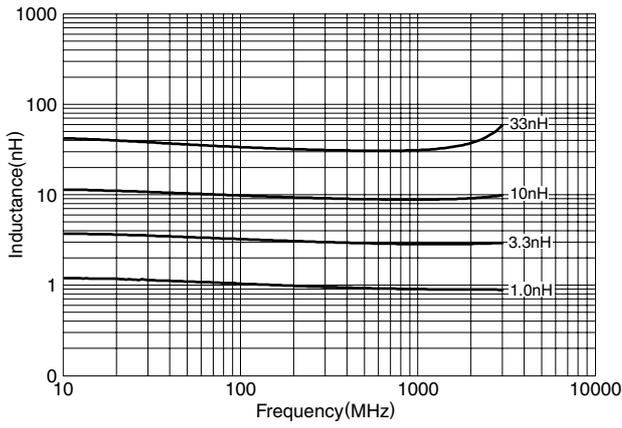

Q vs. FREQUENCY CHARACTERISTICS

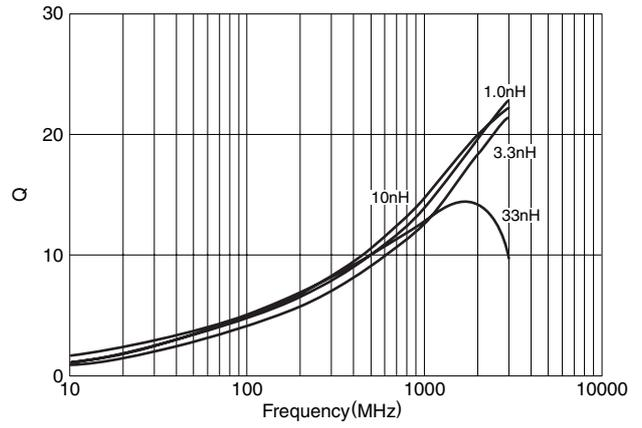

PACKAGING STYLES REEL DIMENSIONS

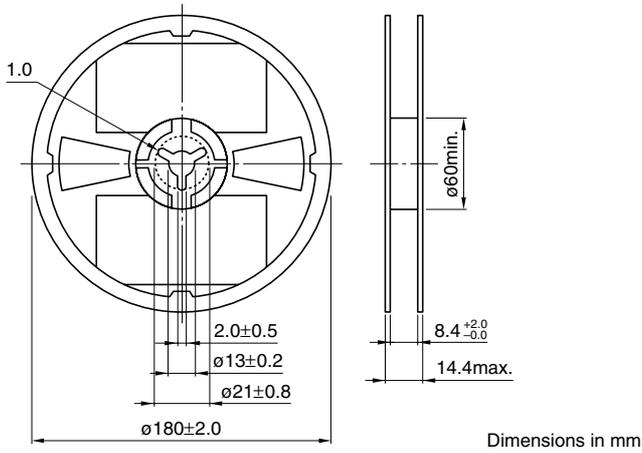

TAPE DIMENSIONS

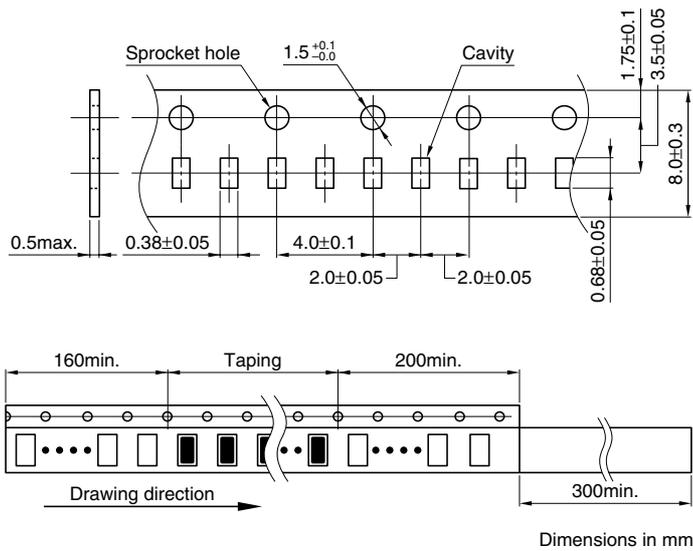

• All specifications are subject to change without notice.

Inductors for High-frequency Circuits Multilayer/High-SRF

Conformity to RoHS Directive

MLK Series MLK1005

FEATURES

- Inductance values are supported from 1 to 100nH.
- With the adoption of a giga-spiral laminated structure, self-resonant frequency higher than that of the MLG structure can be obtained, while the decrease of Q in the GHz band is limited.
- Advanced monolithic structure is formed using a multilayering and sintering process with ceramic and conductive materials for high-frequency.
- There is no directivity.
- The products contain no lead and also support lead-free soldering.
- It is a product conforming to RoHS directive.

APPLICATIONS

For high-frequency applications including mobile phones, high frequency modules (PA, VCO, FEM etc.), Bluetooth, W-LAN, UWB and tuners.

SHAPES AND DIMENSIONS

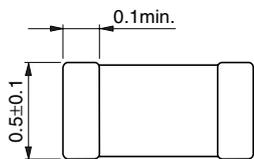
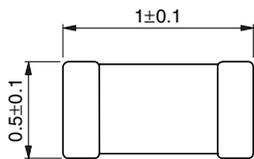

Weight: 1.0mg



RECOMMENDED PC BOARD PATTERN

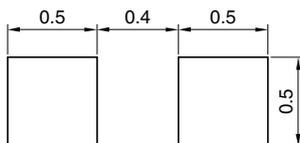

Dimensions in mm

RECOMMENDED SOLDERING CONDITION REFLOW SOLDERING

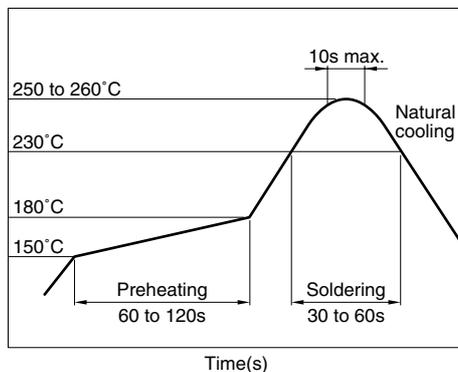

- Conformity to RoHS Directive: This means that, in conformity with EU Directive 2002/95/EC, lead, cadmium, mercury, hexavalent chromium, and specific bromine-based flame retardants, PBB and PBDE, have not been used, except for exempted applications.

- Please contact our Sales office when your application is considered the following:
The device's failure or malfunction may directly endanger human life (e.g. application for automobile/aircraft/medical/nuclear power devices, etc.)

- All specifications are subject to change without notice.

PRODUCT IDENTIFICATION

MLK	1005	S	2N2	S	T	□□□
(1)	(2)	(3)	(4)	(5)	(6)	(7)

(1) Series name

(2) Dimensions L×W

1005	1.0×0.5mm (L×W)
------	-----------------

(3) Type name

(4) Inductance

2N2	2.2nH
12N	12nH
R10	100nH

(5) Tolerance

S	±0.3nH
J	±5%

(6) Packaging style

T	Taping (reel)
---	---------------

(7) TDK internal code

SPECIFICATIONS

Operating temperature range	-55 to +125°C
Storage temperature range	-55 to +125°C(After mount)

PACKAGING STYLE AND QUANTITIES

Packaging style	Quantity
Taping	10000 pieces/reel

HANDLING AND PRECAUTIONS

- Before soldering, be sure to preheat components.
The preheating temperature should be set so that the temperature difference between the solder temperature and product temperature does not exceed 150°C.
- After mounting components onto the printed circuit board, do not apply stress through board bending or mishandling.
- When hand soldering, apply the soldering iron to the printed circuit board only. Temperature of the iron tip should not exceed 350°C. Soldering time should not exceed 3 seconds.

ELECTRICAL CHARACTERISTICS

Inductance (nH)	Inductance tolerance	Q min.	Test frequency L, Q (MHz)	Self-resonant frequency (GHz)		DC resistance (Ω)		Rated current (mA)max.	Part No.*
				min.	typ.	max.	typ.		
1.0	$\pm 0.3\text{nH}$	5	100	12.0	16.9	0.10	0.05	500	MLK1005S1N0□T
1.1	$\pm 0.3\text{nH}$	5	100	11.5	14.8	0.12	0.05	500	MLK1005S1N1□T
1.2	$\pm 0.3\text{nH}$	5	100	11.0	14.4	0.12	0.05	500	MLK1005S1N2□T
1.3	$\pm 0.3\text{nH}$	5	100	10.0	12.6	0.15	0.06	500	MLK1005S1N3□T
1.5	$\pm 0.3\text{nH}$	6	100	9.5	12.2	0.15	0.06	500	MLK1005S1N5□T
1.6	$\pm 0.3\text{nH}$	6	100	9.0	11.9	0.17	0.06	500	MLK1005S1N6□T
1.8	$\pm 0.3\text{nH}$	6	100	8.5	10.9	0.17	0.07	500	MLK1005S1N8□T
2.0	$\pm 0.3\text{nH}$	6	100	8.3	10.0	0.18	0.08	500	MLK1005S2N0□T
2.2	$\pm 0.3\text{nH}$	6	100	8.0	9.6	0.18	0.08	500	MLK1005S2N2□T
2.4	$\pm 0.3\text{nH}$	6	100	7.8	9.5	0.20	0.09	500	MLK1005S2N4□T
2.7	$\pm 0.3\text{nH}$	6	100	7.5	9.1	0.20	0.10	500	MLK1005S2N7□T
3.0	$\pm 0.3\text{nH}$	6	100	7.2	8.5	0.22	0.10	400	MLK1005S3N0□T
3.3	$\pm 0.3\text{nH}$	7	100	7.0	8.3	0.22	0.11	400	MLK1005S3N3□T
3.6	$\pm 0.3\text{nH}$	7	100	6.8	8.1	0.25	0.11	400	MLK1005S3N6□T
3.9	$\pm 0.3\text{nH}$	7	100	6.5	7.8	0.25	0.12	400	MLK1005S3N9□T
4.3	$\pm 0.3\text{nH}$	7	100	6.3	7.4	0.28	0.13	400	MLK1005S4N3□T
4.7	$\pm 0.3\text{nH}$	7	100	6.0	6.9	0.28	0.13	400	MLK1005S4N7□T
5.1	$\pm 0.3\text{nH}$	7	100	5.8	7.0	0.30	0.15	400	MLK1005S5N1□T
5.6	$\pm 0.3\text{nH}$	7	100	5.7	6.7	0.30	0.15	400	MLK1005S5N6□T
6.2	$\pm 0.3\text{nH}$	7	100	5.6	6.5	0.35	0.18	400	MLK1005S6N2□T
6.8	$\pm 5\%$	7	100	5.5	6.3	0.35	0.18	400	MLK1005S6N8□T
7.5	$\pm 5\%$	7	100	5.0	6.0	0.38	0.20	350	MLK1005S7N5□T
8.2	$\pm 5\%$	7	100	5.0	6.0	0.38	0.21	350	MLK1005S8N2□T
9.1	$\pm 5\%$	7	100	4.8	5.9	0.42	0.23	350	MLK1005S9N1□T
10	$\pm 5\%$	7	100	4.7	5.2	0.42	0.23	350	MLK1005S10N□T
12	$\pm 5\%$	7	100	4.3	5.3	0.47	0.27	350	MLK1005S12N□T
15	$\pm 5\%$	7	100	4.0	4.8	0.50	0.33	300	MLK1005S15N□T
18	$\pm 5\%$	7	100	4.0	4.7	0.60	0.38	250	MLK1005S18N□T
22	$\pm 5\%$	7	100	3.5	4.4	0.70	0.46	200	MLK1005S22N□T
27	$\pm 5\%$	7	100	3.0	3.9	0.80	0.53	200	MLK1005S27N□T
33	$\pm 5\%$	7	100	2.5	3.5	0.90	0.59	200	MLK1005S33N□T
39	$\pm 5\%$	6	100	2.0	3.1	1.00	0.65	200	MLK1005S39N□T
47	$\pm 5\%$	6	100	1.8	3.0	1.20	0.74	200	MLK1005S47N□T
56	$\pm 5\%$	6	100	1.5	2.6	1.30	0.84	200	MLK1005S56N□T
68	$\pm 5\%$	6	100	1.4	2.4	1.50	1.01	150	MLK1005S68N□T
82	$\pm 5\%$	6	100	1.3	2.2	1.80	1.39	150	MLK1005S82N□T
100	$\pm 5\%$	6	100	1.1	1.9	2.20	1.60	100	MLK1005SR10□T
110	$\pm 5\%$	6	100	1.1	2.0	2.70	1.89	100	MLK1005SR11□T
120	$\pm 5\%$	6	100	1.1	1.9	3.00	2.08	100	MLK1005SR12□T
130	$\pm 5\%$	6	100	1.1	1.8	3.30	2.28	100	MLK1005SR13□T
150	$\pm 5\%$	6	100	1.1	1.7	5.00	3.58	80	MLK1005SR15□T
160	$\pm 5\%$	6	100	1.1	1.7	5.20	3.79	80	MLK1005SR16□T
180	$\pm 5\%$	6	100	1.1	1.6	6.00	4.28	80	MLK1005SR18□T
200	$\pm 5\%$	6	100	1.1	1.5	6.20	4.56	70	MLK1005SR20□T
220	$\pm 5\%$	6	100	1.0	1.4	6.20	4.54	70	MLK1005SR22□T
240	$\pm 5\%$	6	100	1.0	1.3	6.50	4.84	70	MLK1005SR24□T
270	$\pm 5\%$	6	100	0.9	1.2	6.50	4.78	70	MLK1005SR27□T
300	$\pm 5\%$	6	100	0.9	1.2	7.50	5.37	70	MLK1005SR30□T
330	$\pm 5\%$	6	100	0.85	1.1	8.00	5.82	70	MLK1005SR33□T

* □: Please specify inductance tolerance, S ($\pm 0.3\text{nH}$) or J ($\pm 5\%$).

• Test equipment

Inductance Q : HP4291A+16193A, or equivalent

SRF: HP8720C, or equivalent

Rdc: YOKOGAWA TYPE7561, or equivalent

L, Q vs. FREQUENCY CHARACTERISTICS

Part No.	Inductance(nH)typ.					Q typ.				
	500MHz	800MHz	1.8GHz	2.0GHz	2.4GHz	500MHz	800MHz	1.8GHz	2.0GHz	2.4GHz
MLK1005S1N0	0.9	0.9	0.9	0.9	0.9	16	20	30	32	36
MLK1005S1N1	1.0	1.0	1.0	1.0	1.0	16	20	32	35	39
MLK1005S1N2	1.1	1.1	1.1	1.1	1.1	15	18	28	30	33
MLK1005S1N3	1.2	1.2	1.2	1.2	1.2	17	20	33	35	39
MLK1005S1N5	1.4	1.4	1.4	1.4	1.4	15	19	29	31	34
MLK1005S1N6	1.5	1.5	1.5	1.5	1.5	17	21	34	36	40
MLK1005S1N8	1.7	1.7	1.7	1.7	1.7	16	21	32	33	37
MLK1005S2N0	1.9	1.8	1.9	1.9	1.9	16	20	32	34	38
MLK1005S2N2	2.0	2.0	2.0	2.0	2.1	15	19	29	31	34
MLK1005S2N4	2.2	2.2	2.2	2.3	2.3	16	20	32	34	38
MLK1005S2N7	2.5	2.5	2.5	2.6	2.6	17	22	33	35	39
MLK1005S3N0	2.8	2.8	2.8	2.9	2.9	18	22	35	36	41
MLK1005S3N3	3.1	3.1	3.1	3.1	3.2	16	20	31	32	36
MLK1005S3N6	3.4	3.3	3.4	3.5	3.5	17	22	33	35	39
MLK1005S3N9	3.7	3.6	3.7	3.7	3.8	17	21	32	33	37
MLK1005S4N3	4.0	4.0	4.1	4.2	4.3	17	22	34	35	39
MLK1005S4N7	4.4	4.4	4.5	4.6	4.7	17	22	33	35	38
MLK1005S5N1	4.8	4.8	4.9	5.0	5.1	17	22	33	35	38
MLK1005S5N6	5.3	5.2	5.4	5.5	5.7	17	22	33	34	38
MLK1005S6N2	5.8	5.8	6.0	6.2	6.4	18	23	34	35	39
MLK1005S6N8	6.4	6.4	6.6	6.7	7.0	17	22	32	33	36
MLK1005S7N5	7.1	7.0	7.4	7.6	7.9	18	23	34	36	38
MLK1005S8N2	7.7	7.7	8.1	8.3	8.6	19	23	34	36	38
MLK1005S9N1	8.6	8.6	9.1	9.3	9.7	18	23	34	36	38
MLK1005S10N	9.4	9.4	10.0	10.2	10.7	19	23	34	35	38
MLK1005S12N	11.3	11.3	12.1	12.4	13.0	19	23	34	35	37
MLK1005S15N	14.2	14.2	15.3	15.8	16.8	18	23	33	34	35
MLK1005S18N	17.0	17.1	18.6	19.2	20.6	18	23	32	33	34
MLK1005S22N	20.8	20.9	23.0	23.9	25.8	18	23	32	33	34
MLK1005S27N	25.6	25.9	29.8	31.5	35.7	18	23	30	30	28
MLK1005S33N	31.4	31.9	37.6	40.2		18	23	29	29	
MLK1005S39N	37.2	38.1	48.9			17	21	24		
MLK1005S47N	45.0	46.2	60.6			18	21	24		
MLK1005S56N	53.7	55.4	76.7			17	21	22		
MLK1005S68N	65.5	68.4	105.6			17	20	18		
MLK1005S82N	79.3	83.6	142.7			16	19	15		
MLK1005SR10	97.1	103.2	199.4			15	18	13		
MLK1005SR11	107.8	115.9				16	18			
MLK1005SR12	118.0	127.8				16	18			
MLK1005SR13	127.5	139.5				14	16			
MLK1005SR15	149.4	166.0				16	17			
MLK1005SR16	160.5	179.4				16	18			
MLK1005SR18	181.1	204.1				16	17			
MLK1005SR20	202.8	231.9				15	17			
MLK1005SR22	225.7	266.8				15	15			
MLK1005SR24	248.3	299.6				14	15			
MLK1005SR27	290.0	386.0				14	12			
MLK1005SR30	323.1	432.6				14	12			
MLK1005SR33	358.9	493.1				13	12			

TYPICAL ELECTRICAL CHARACTERISTICS INDUCTANCE vs. FREQUENCY CHARACTERISTICS

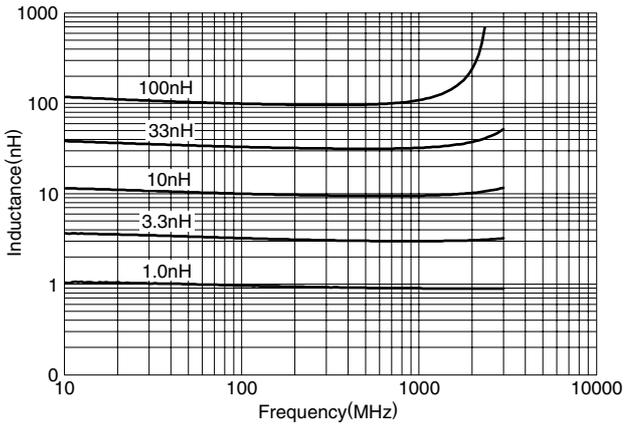

Q vs. FREQUENCY CHARACTERISTICS

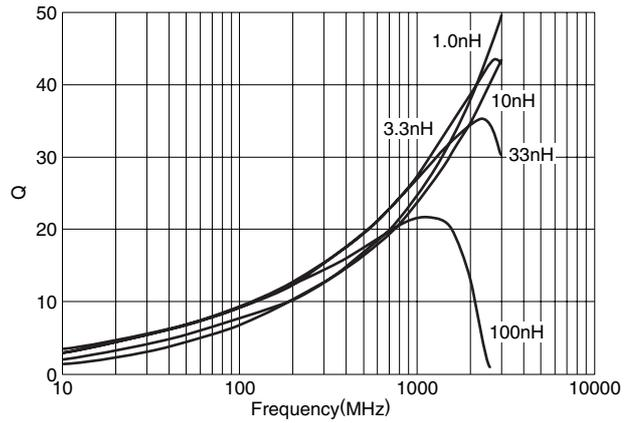

PACKAGING STYLES REEL DIMENSIONS

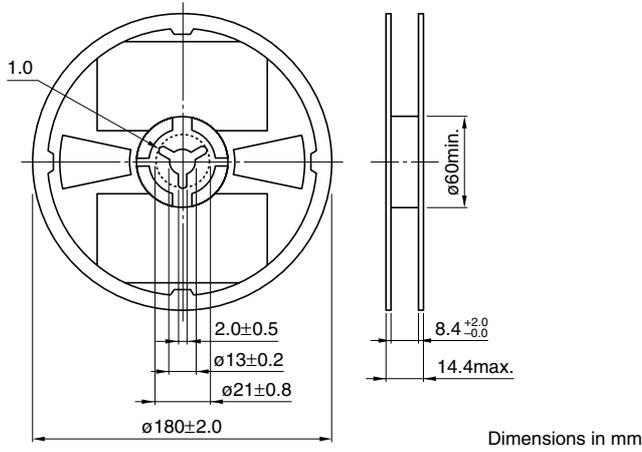

TAPE DIMENSIONS

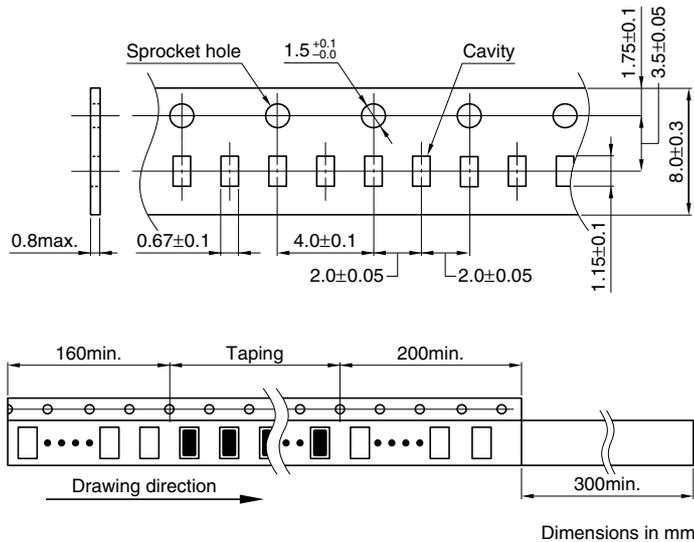

• All specifications are subject to change without notice.