

Specification

- Part No. : **WM.90.A.305111**
- Product Name : Wall Mount Flexible Whip Monopole
High Gain 4G/3G/2G Wide-band Cellular Antenna
- Feature : 698-960MHz /1710-2690MHz
Suitable for Cat-M1/LTE-M
Unique - High peak gain on all bands
Wide-band High efficiency
Flexible Inner Steel Core Whip
IP65, Robust Structure, Aesthetic
3m CFD-200 SMA(M)ST
Cable is hidden internally
RoHS & Reach Compliant



1. Introduction

The WM.90 wall mount flexible whip monopole has high performance on all common 4G/3G/2G & Cat M1/LTE-M bands used worldwide. Taoglas specifications are compiled completely from real-life testing in state of the art CTIA approved 3D anechoic chambers. Peak gain, average gain/efficiency are both optimized to provide extended coverage area in the azimuth (horizontal direction), while also maintaining an Omni-directional pattern for close in reception/transmission. Testing of the whip antenna on the bracket, in free-space, and on a reference ground-plane has been done to show the benefit of the L-bracket.

This antenna delivers wider coverage areas and more reliable connections for professional customers in the automotive, industrial industries. The whip is made up of a flexible inner steel core covered by TPU so extremely resistant to collisions and maintaining its original shape and RF performance. The whip and the connection internally to the bracket is IP65 waterproof.

The bracket allows complete concealment of the cable for a more secure integration and cleaner installation. The cable can also be routed out of the back wall of the bracket into the interior of the mounting wall for added security against vandalism. The standard version comes with 3 meters extremely low loss CFD-200 (0.3dB against 0.7dB for RG-58) to allow for flexibility of placement. The cable and connector can be completely customized, the whip itself can also be changed for different frequency bands or gain requirements.

2. Specification

ELECTRICAL							
Frequency (MHz)	698~798	824~896	880~960	1710~1880	1850~1990	1710~2170	2570~2690
Peak Gain (dBi)							
Free Space	-2.11	-1.30	-0.27	2.45	3.35	2.83	3.45
On 30cm*30cm GND	-2.75	-0.84	2.02	4.65	5.09	4.55	4.65
L - Bracket	-1.11	2.53	1.80	1.81	2.23	2.22	1.80
Average Gain (dBi)							
Free Space	-6.30	-5.33	-4.59	-1.85	-1.51	-1.73	-2.13
On 30cm*30cm GND	-5.76	-4.62	-3.03	-1.73	-1.44	-1.69	-1.84
L - Bracket	-5.58	-2.33	-2.44	-2.71	-3.03	-2.75	-2.88
Efficiency (%)							
Free Space	23.49	29.32	35.08	65.41	70.84	67.30	61.58
On 30cm*30cm GND	26.60	34.93	50.32	67.30	71.81	67.94	65.54
L - Bracket	27.92	58.66	57.15	53.86	49.86	53.24	51.59
Return Loss (dB)	<-3	<-6	<-4	<-5	<-5	<-6	<-6
Impedance	50Ω						
Polarization	Linear						
Radiation Pattern	Omni						
Input Power	2 W						
Tested Power	10 W						
MECHANICAL							
Height	248 ± 5 mm						
Base Diameter	17.08 ± 0.2 mm						
Whip Diameter	4 ± 0.2 mm						
Casing	ABS						
Connector	SMA Male						
Weight	420g						
ENVIRONMENTAL							
Temperature Range	-40°C to 85°C						
Humidity	Non-condensing 65°C 95% RH						

*Tested with 3m CFD-200 SMA(M)ST.

3. Antenna Characteristics

3.1 Return loss

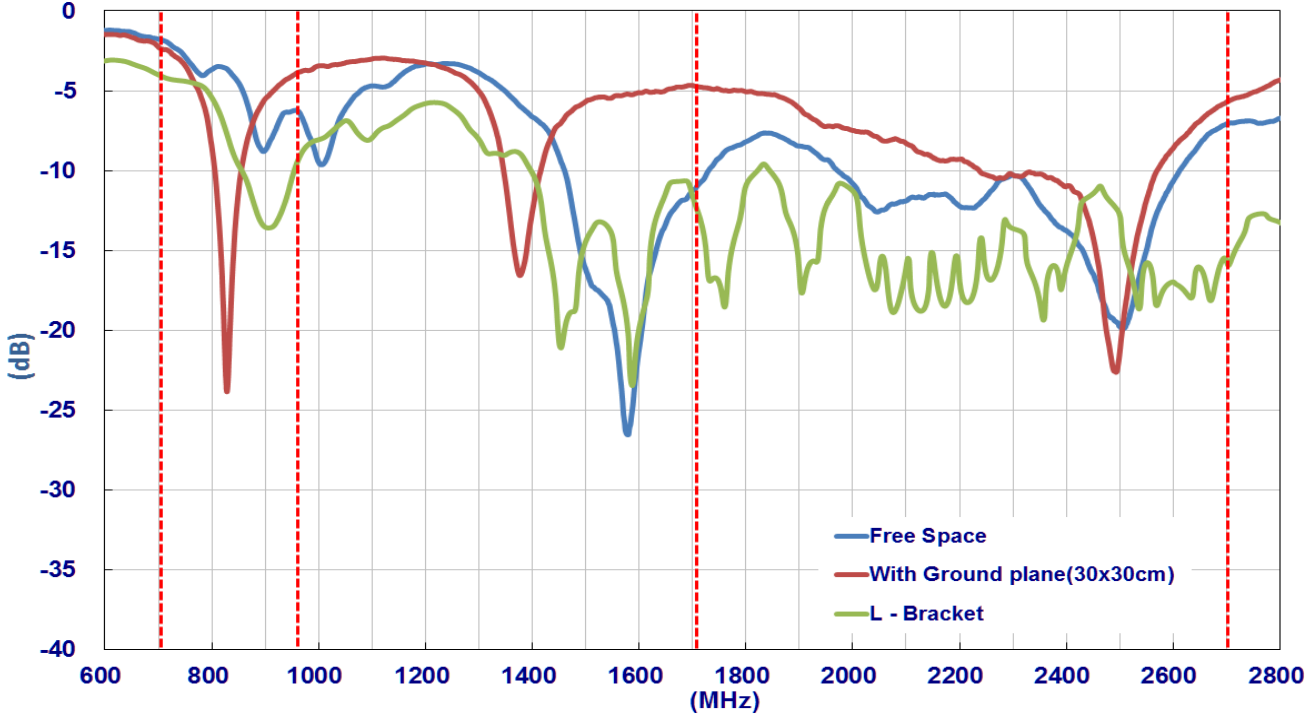

3.2 Antenna Efficiency

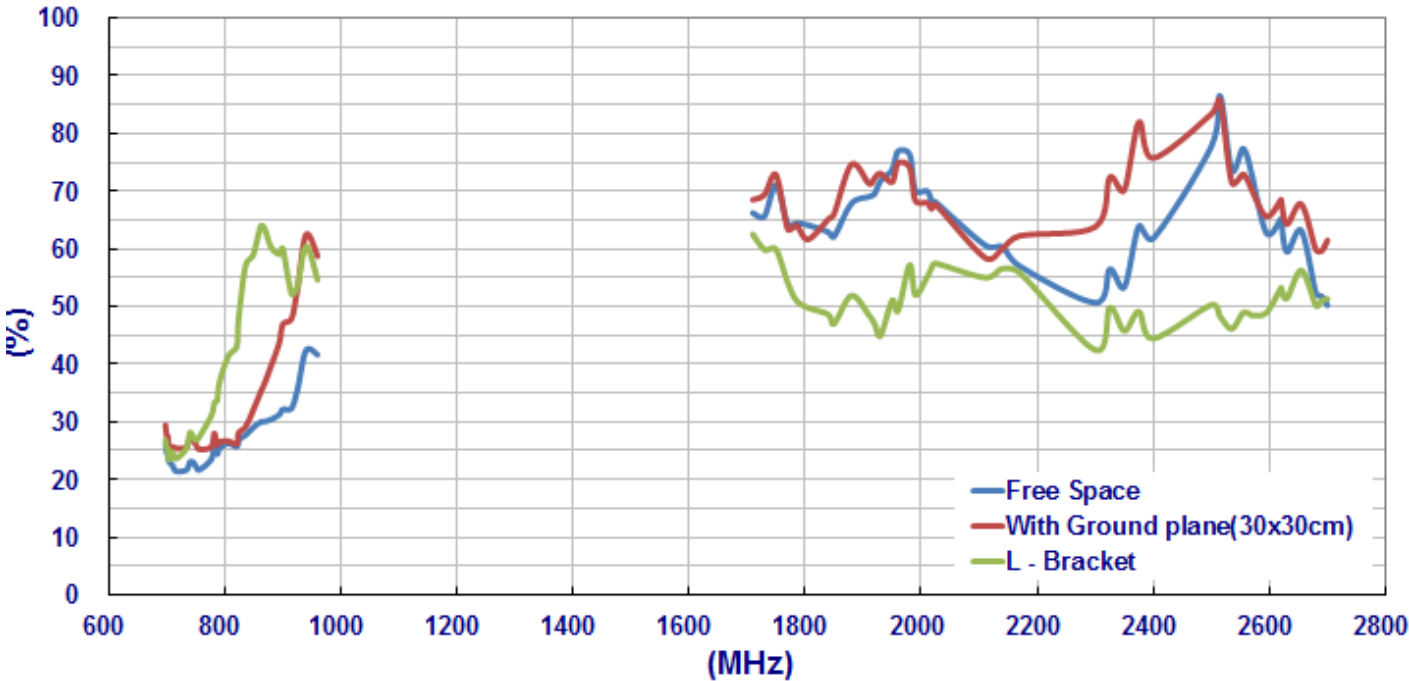

3.3 Peak Gain

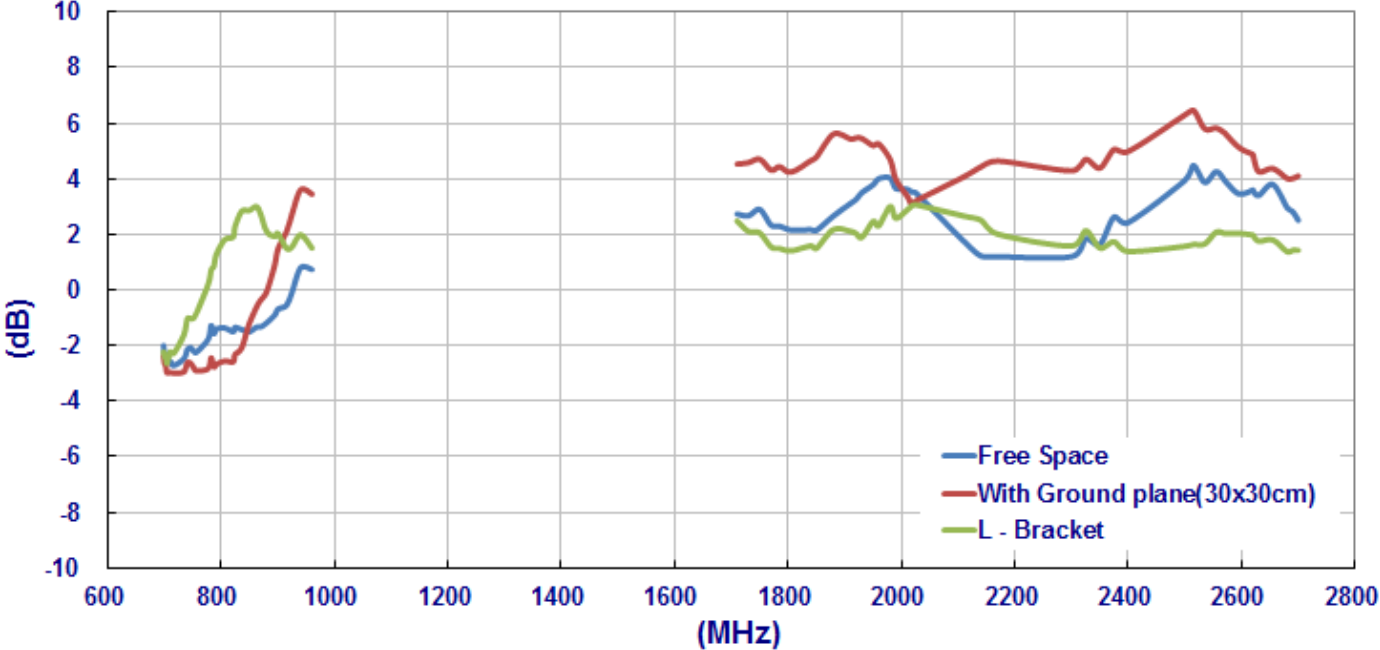

4. Antenna 2D Radiation Patterns

4.1 Antenna Stand Alone

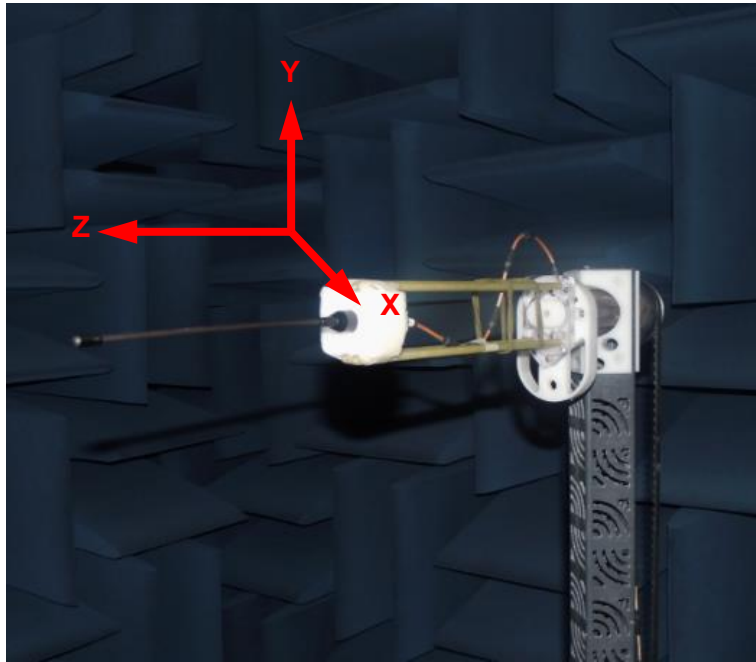

XY Plane

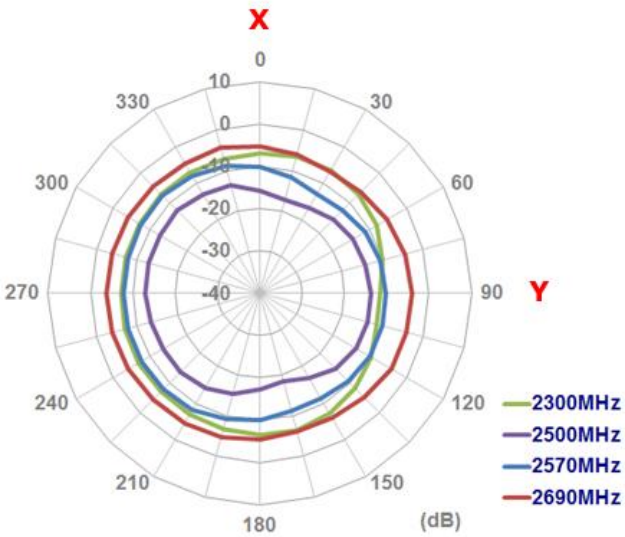
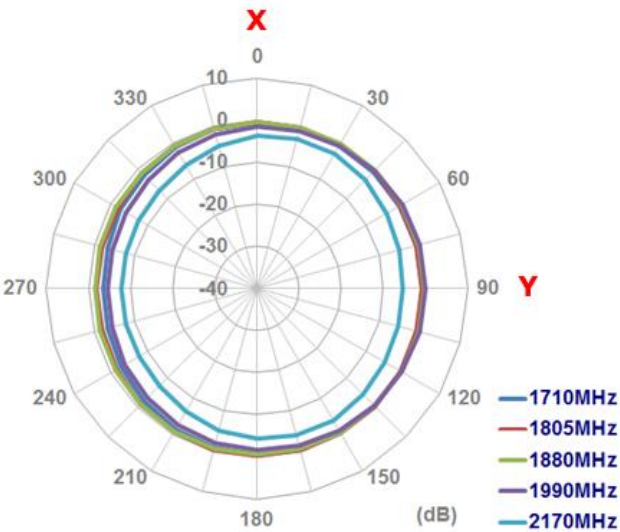
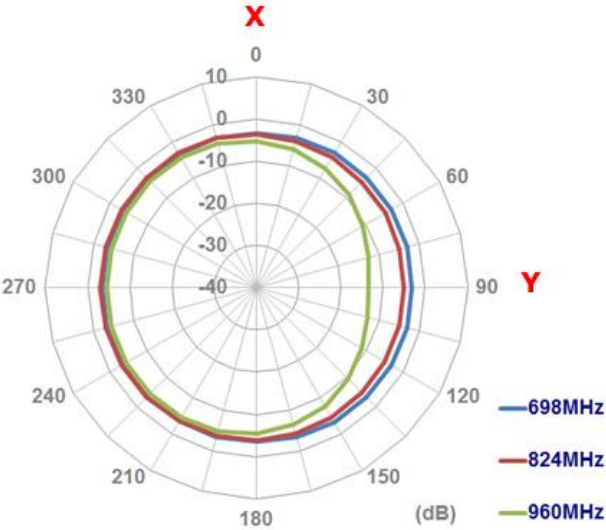

XZ Plane

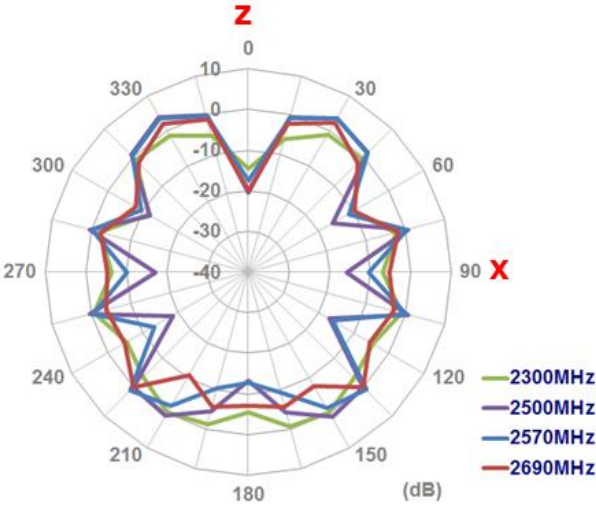
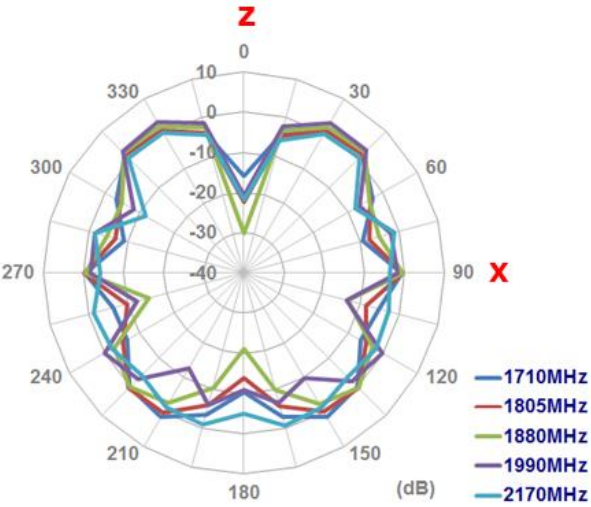
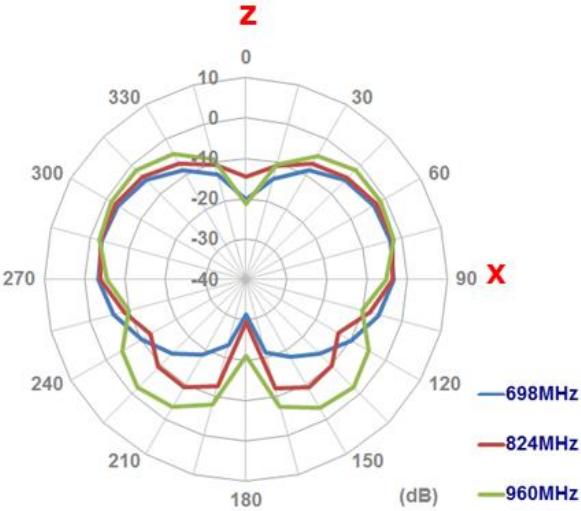

4.2 Antenna with Ground plane (30*30cm)

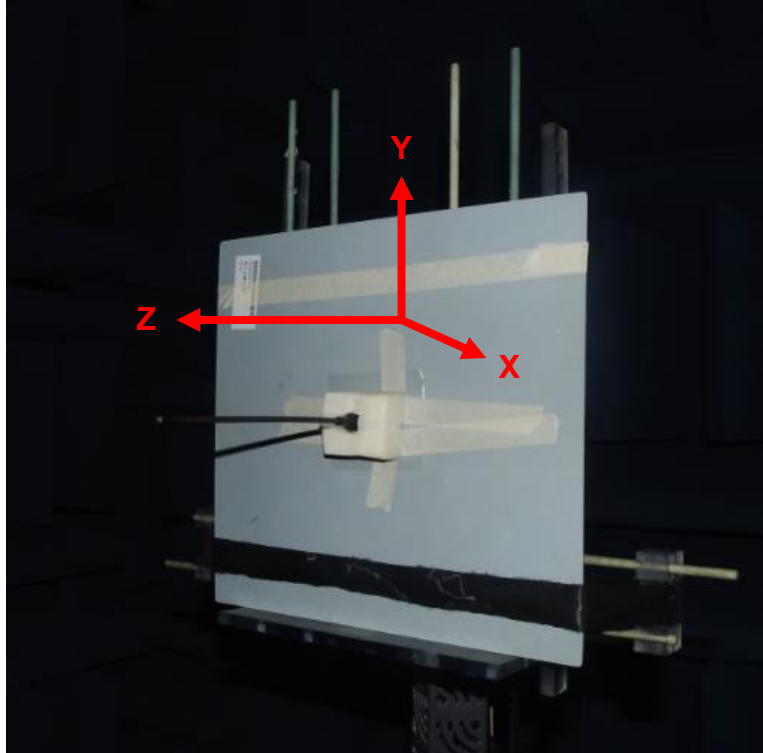

XY Plane

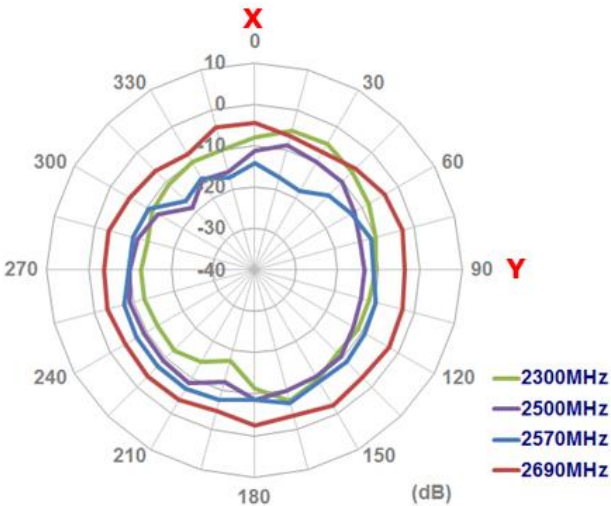
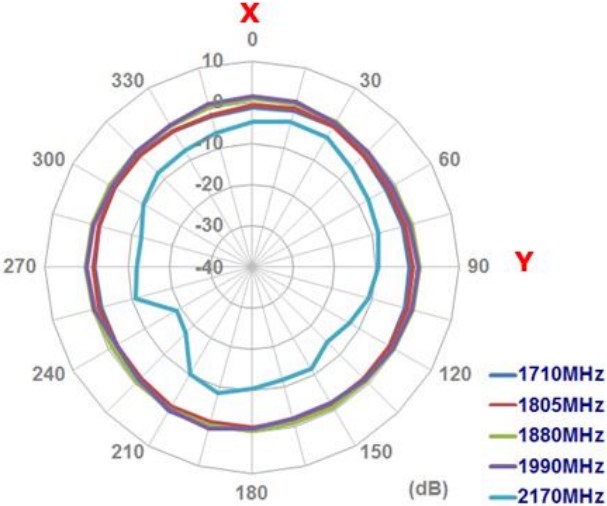
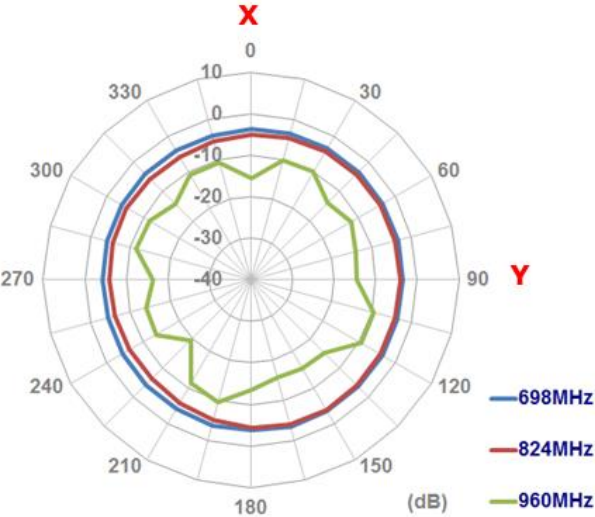

XZ Plane

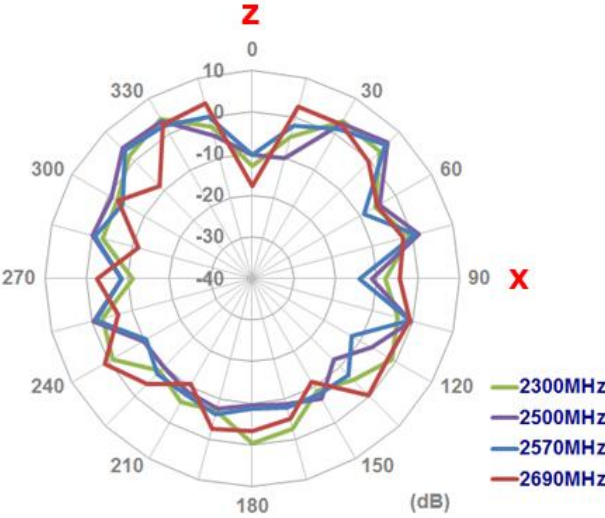
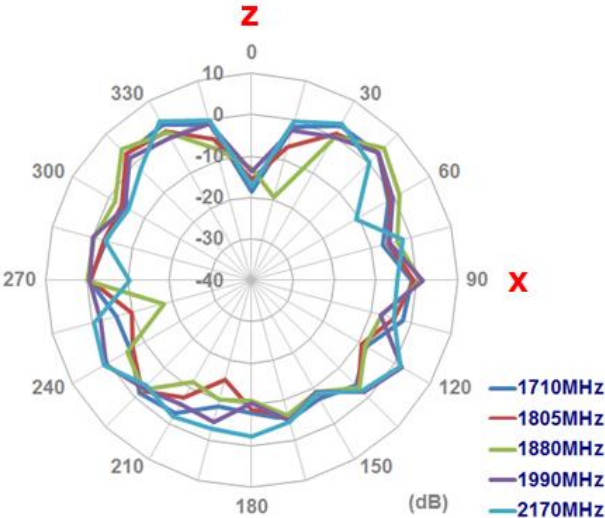
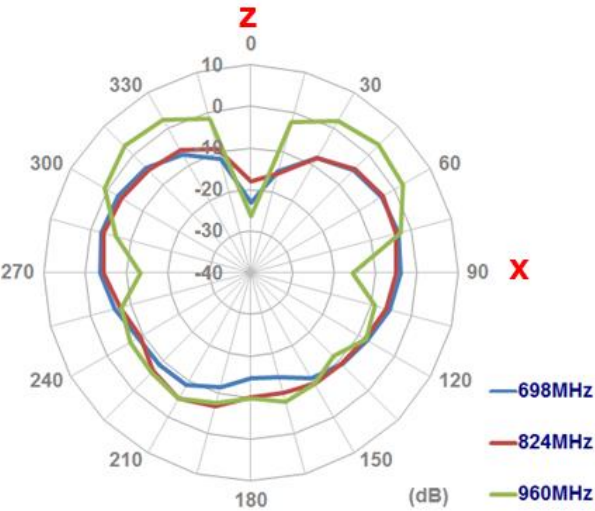

4.3 Antenna with L-Bracket

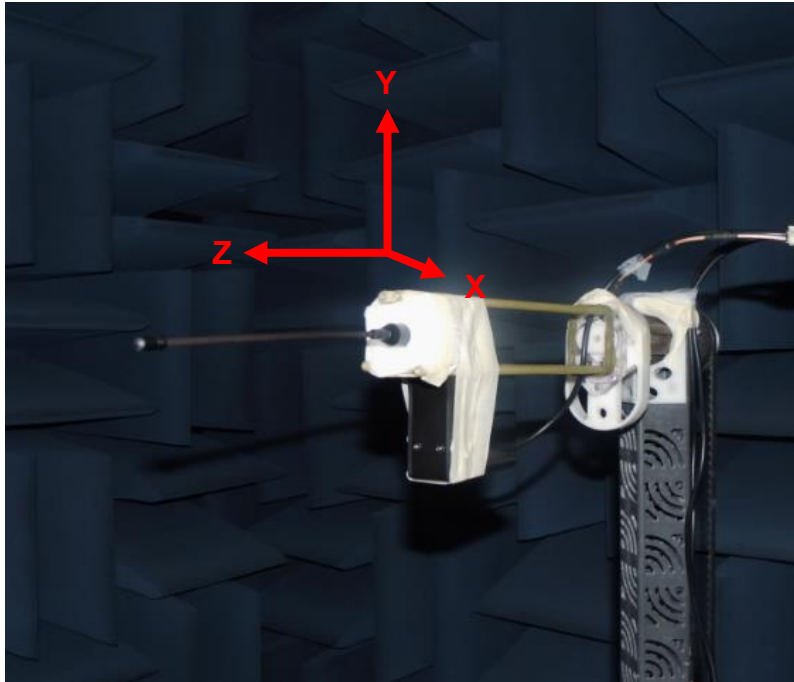

XY Plane

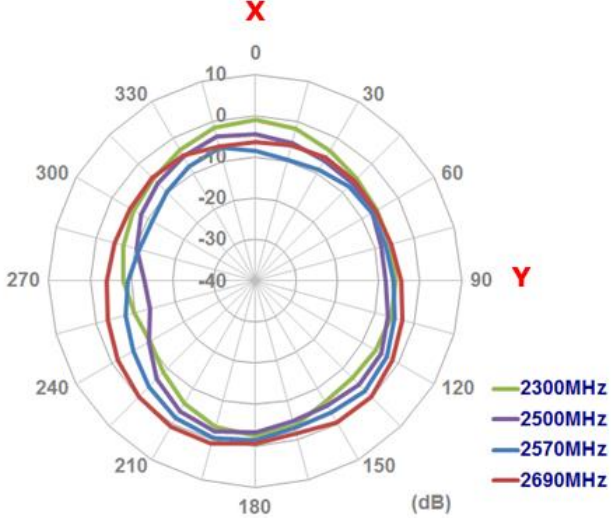
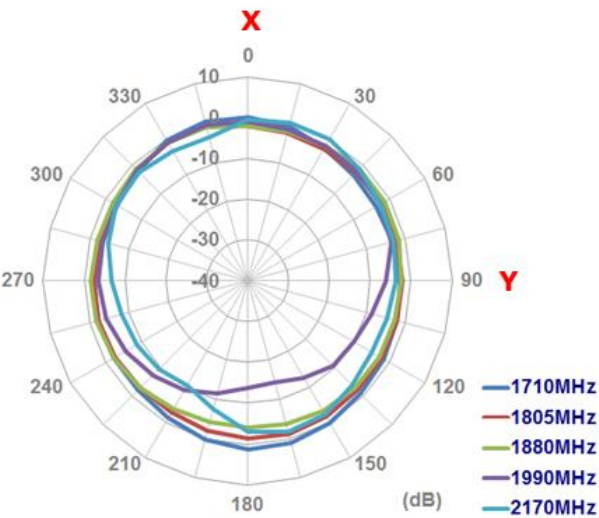
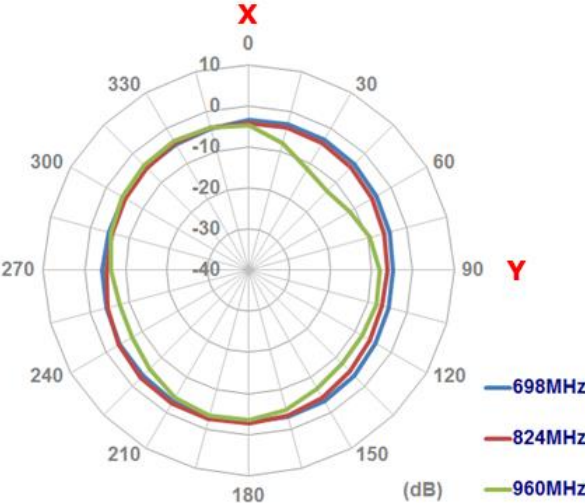

XZ Plane

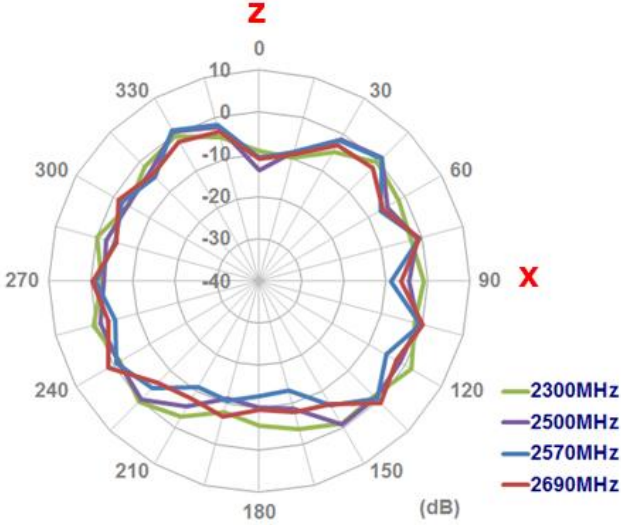
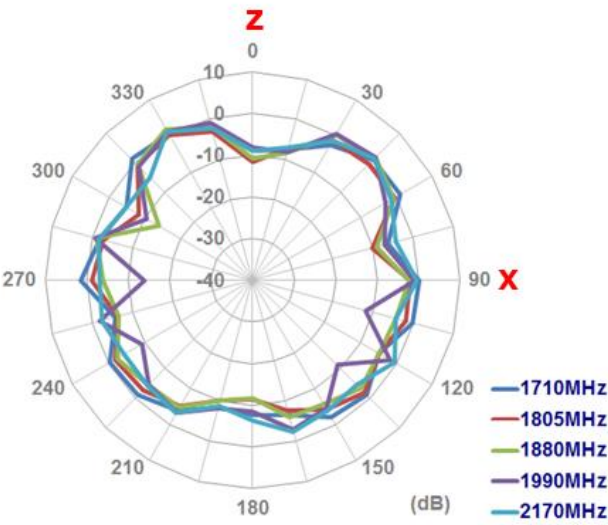
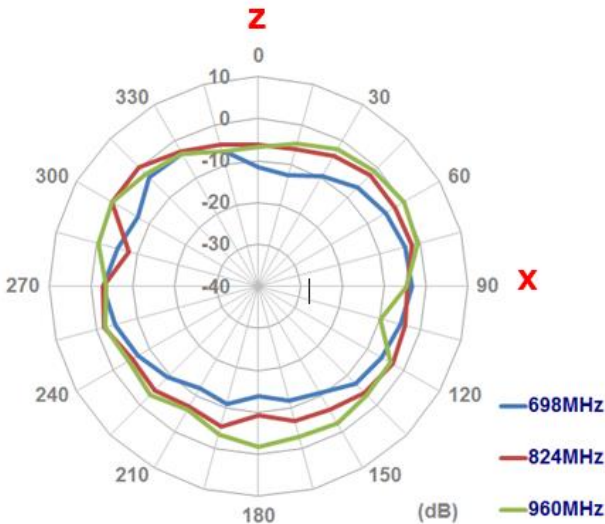

5. Mechanical Drawing

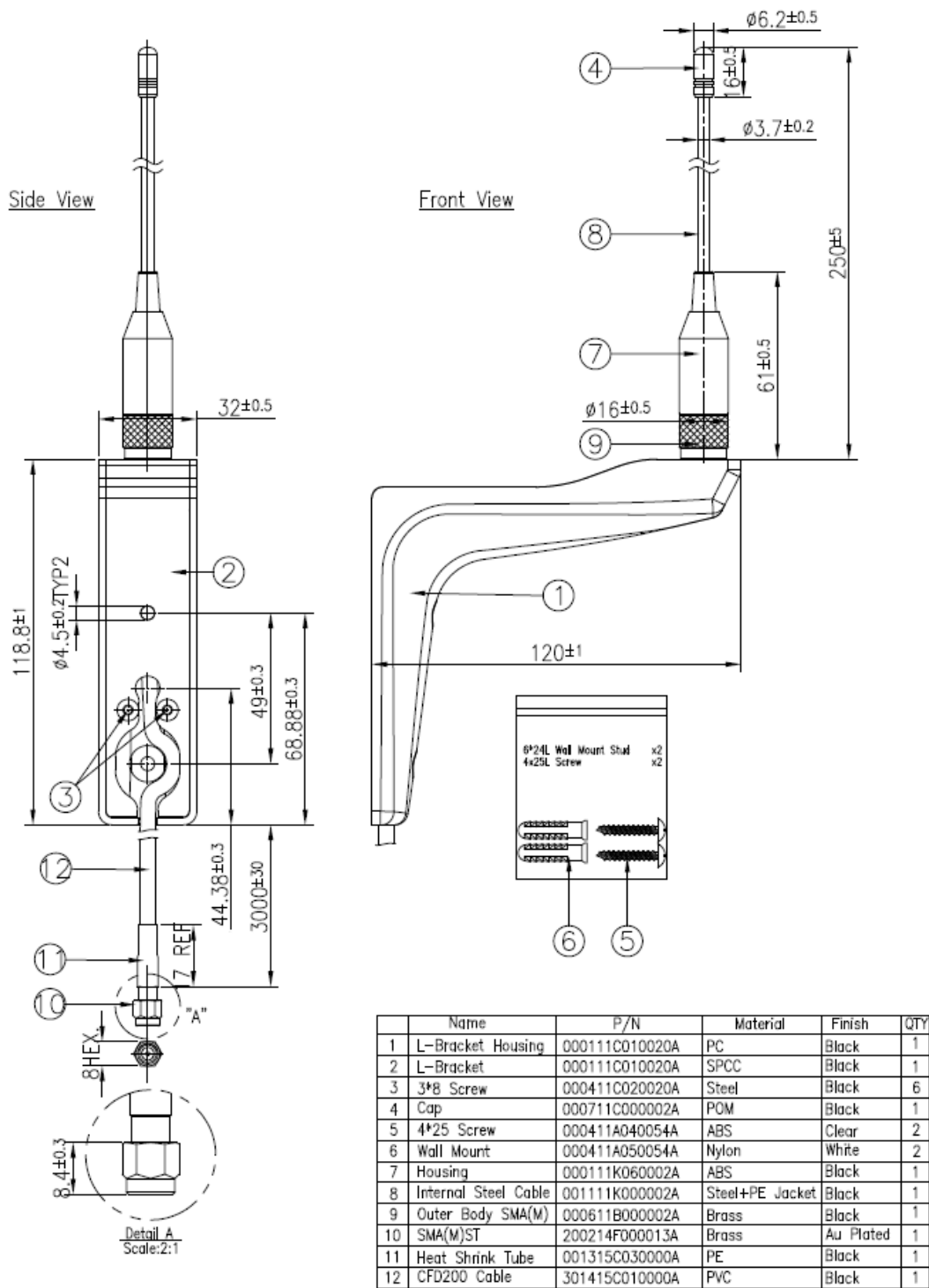

6. Packaging (Unit: mm)

Package:

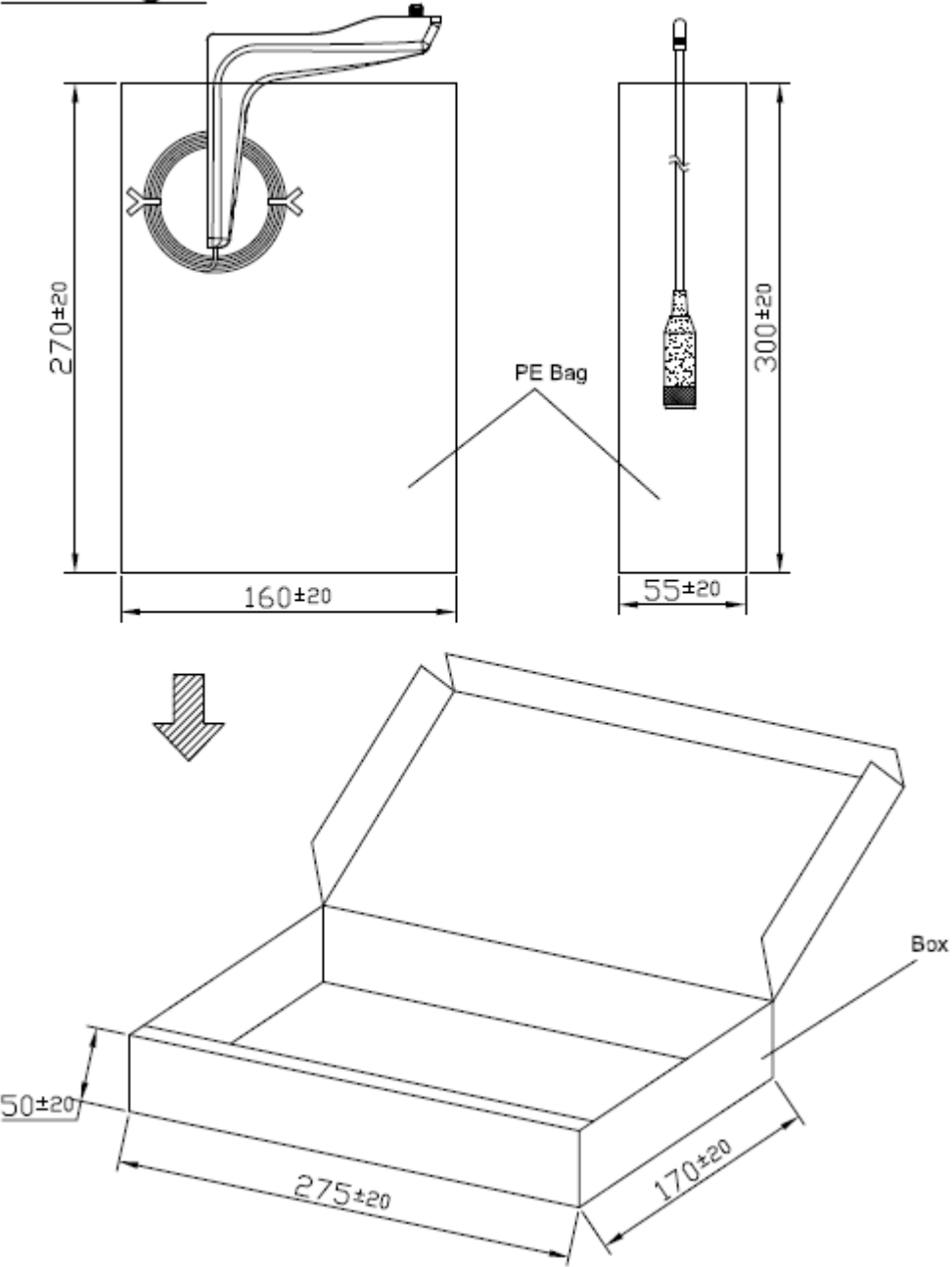

7. Application Note

The performance of WM.90 with L bracket depending on different cable lengths is shown as below.

7.1 Return Loss

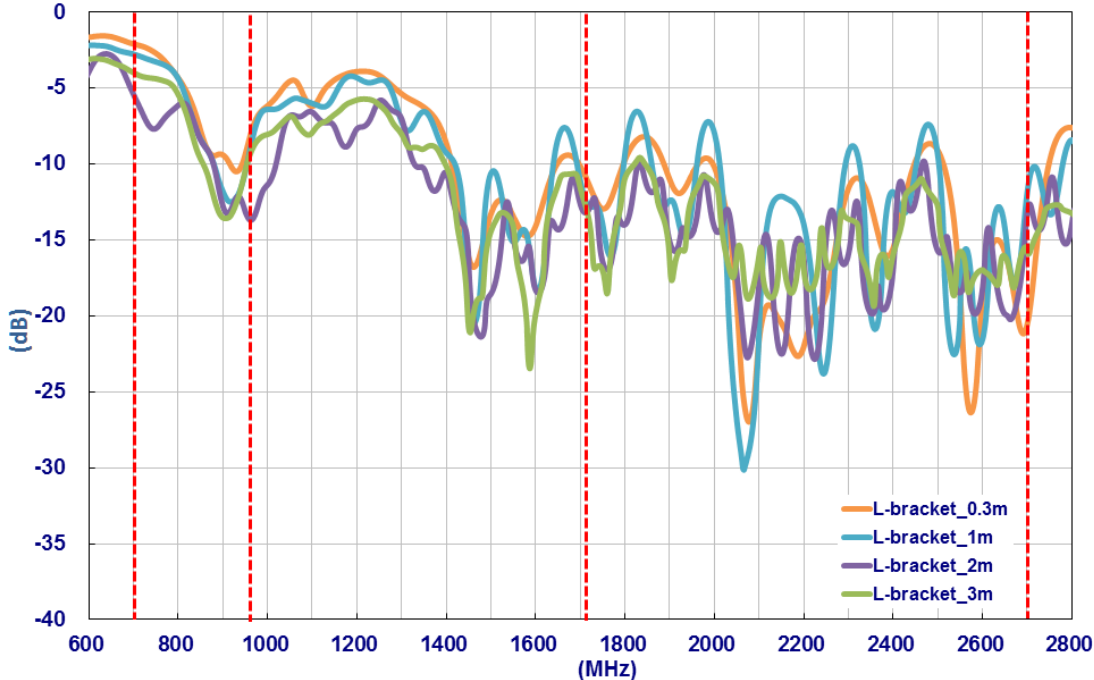

7.2 Efficiency (%)

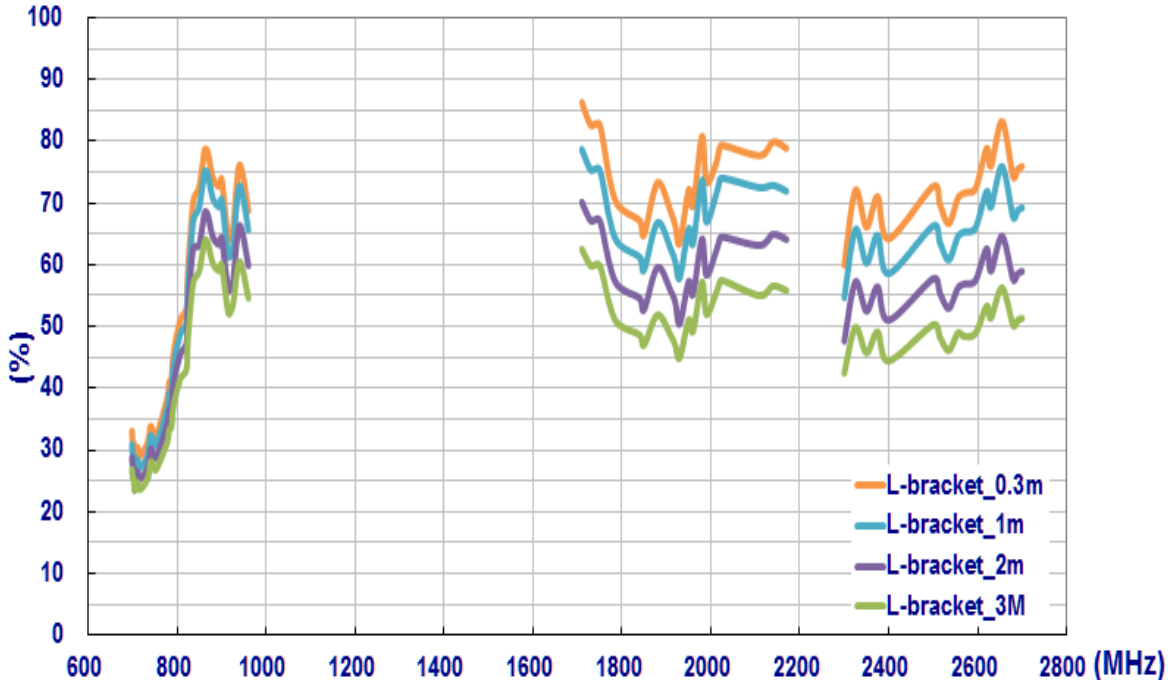

7.3 Average Gain (dBi)

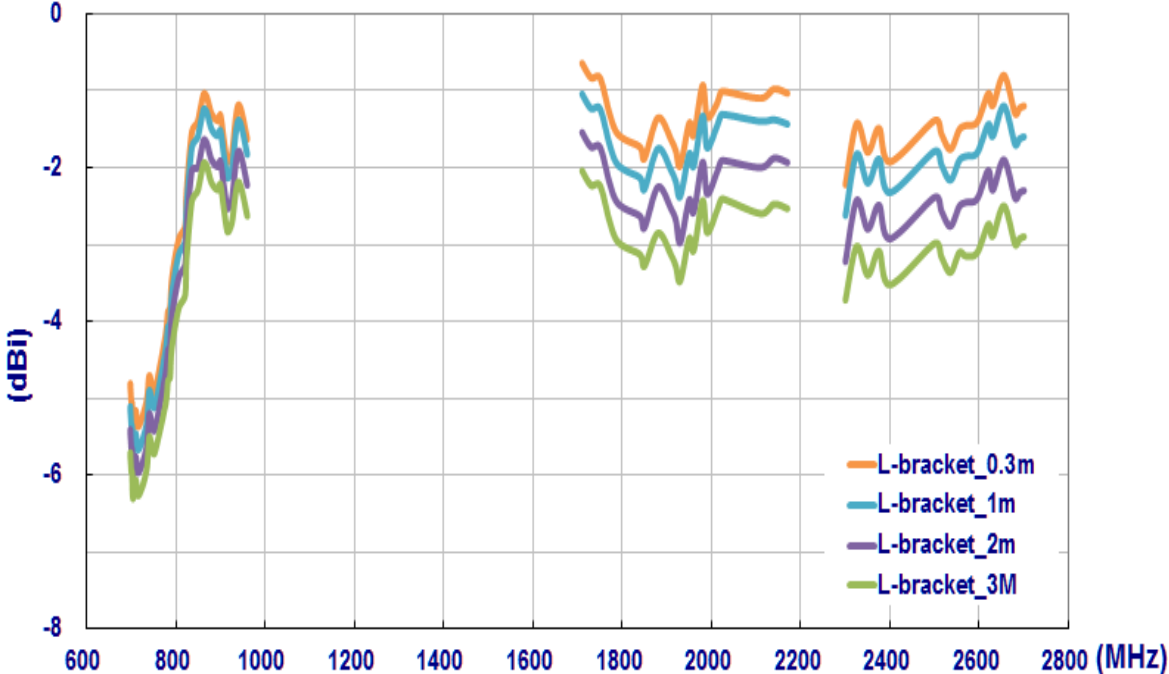

7.4 Peak Gain(dBi)

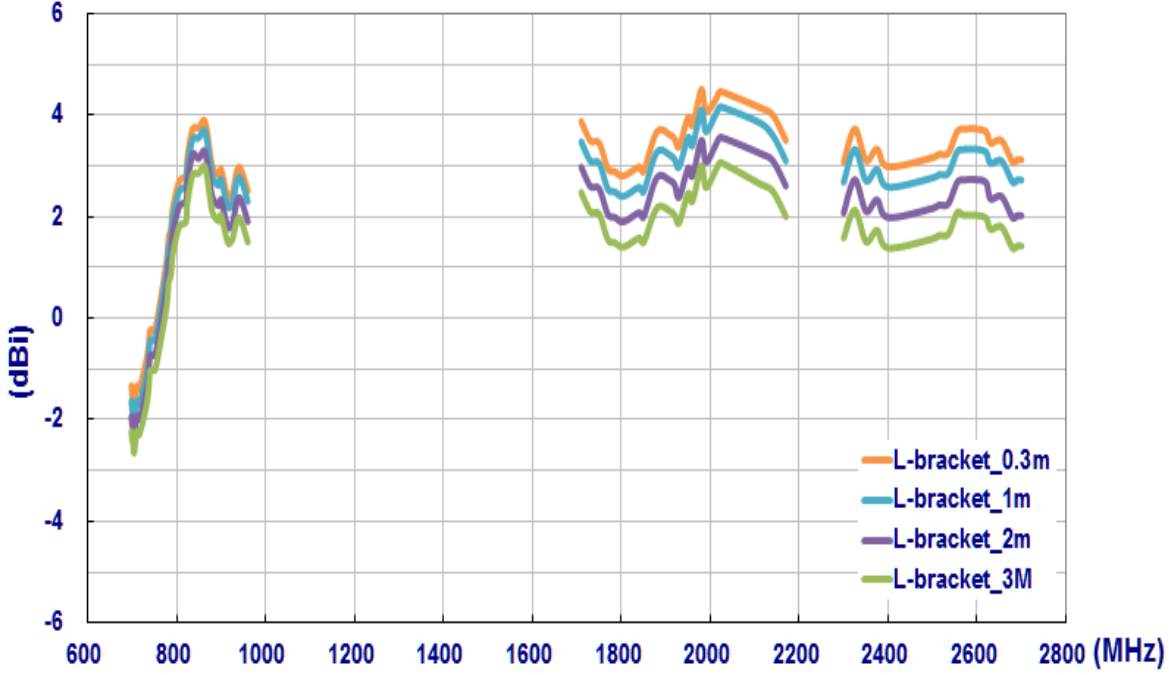



Taoglas makes no warranties based on the accuracy or completeness of the contents of this document and reserves the right to make changes to specifications and product descriptions at any time without notice. Taoglas reserves all rights to this document and the information contained herein.

Reproduction, use or disclosure to third parties without express permission is strictly prohibited.

© Taoglas