



TAOGLAS®



Datasheet

Apex II

Part No:
TG.35.8113

Description:

Apex II - Hinged TG.35 Wideband 5G/4G Antenna

Features:

Highest efficiency for worldwide 5G/4G and Wi-Fi

5G/4G / CAT-M1 / NB-IoT / GPS / Wi-Fi

Compatible also with 2G/3G Applications

5G NR Sub 6GHz

600MHz - 6000MHz Band 71 Applicable

224mm * 58mm * 13mm

Dipole Swivel Terminal Antenna

Hinged 90° termination with SMA(M) Connector

Enhanced hinge structure for Vibration Environments

Connector Customizable

RoHS & REACH Compliant

1. Introduction	3
2. Specifications	4
3. Antenna Characteristics	12
4. 2D Radiation Patterns	17
5. Installation Guide	23
6. Mechanical Drawing	24
7. Packaging	25
<hr/>	
Changelog	26

Taoglas makes no warranties based on the accuracy or completeness of the contents of this document and reserves the right to make changes to specifications and product descriptions at any time without notice. Taoglas reserves all rights to this document and the information contained herein. Reproduction, use or disclosure to third parties without express permission is strictly prohibited.



1. Introduction



The hinged Apex II TG.35 Wideband Dipole Antenna has been designed to cover all Cellular, ISM and Wi-Fi working frequencies in the 600-6000MHz spectrum. Evolved from the already highly successful Apex TG.30, this second generation has the highest wide-band efficiency in its range of any terminal antenna on the market today.

The Apex II has been primarily designed for use with 5G/4G modules and devices that require the highest possible efficiency and peak gain to deliver best in class throughput on all major cellular (2G/3G/4G) bands worldwide for access points, terminals and routers. This also includes CAT-M1 and NB-IoT and the recently introduced 600MHz Extended LTE Band 71. High efficiency is vital for applications such as high speed video and real-time streaming, or high capacity MIMO networks on public transportation.

This attractive slim-line antenna is ground plane independent, meaning it does not need to be connected to the ground-plane of a device to radiate efficiently, on the other hand neither is it seriously detuned by connecting to a ground-plane, thus avoiding a problem notorious to smaller antennas.

It comes with an SMA(M) connector and swivel mechanism that allows the antenna part to be rotated to fit in tight environments. The 90° hinge structure has been improved and strengthened so that the antenna in a 90° position would not fall down to 180° in vibration environment.

The Apex II is backward compatible with 3G and 2G cellular applications such as HSPA, GSM, GPRS, UMTS, Wi-Fi and even has GPS included for Assisted GPS and/or E911 applications.

In summary the Apex II is the ideal solution for any device requiring high, reliable performance. It will meet most type approval or carrier certification requirements from an efficiency standpoint. The antenna also makes an excellent reference antenna for test purposes. It has been designed as an omni-directional antenna and the radiation patterns prove this, being stable across all bands.

Connector type is customizable. Housing is also available in black. Contact Taoglas regional sales office for more information.

2. Specifications

Electrical												
Frequency (MHz)	5G NR Band 71	LTE 700	GSM 850/900	5G Band 74, 75, 76	DCS	PCS	UMTS1	LTE 2600	5G Band 77, 78, 79	5G Mid	Japan 5G	LTE5200/Wi-Fi5800
	617 ~698	698 ~824	824 ~960	1427 ~1518	1710 ~1880	1850 ~1990	1920 ~2170	2300 ~2690	3300 ~3500	3400 ~3800	3600 ~4600	5150 ~5925
Efficiency (%)												
Bent Free Space	63.06	82.91	73.32	73.9	75.25	64.56	64.84	49.62	25.11	24.44	28.35	59.82
Straight Free Space	64.39	79.06	74.77	69.45	73.15	66.2	63.09	54.84	24.48	24.95	28.25	58.28
Straight 30cm*30cm ground plane centre	62.97	78.33	75.41	63.49	65.09	55.87	56.87	52.56	21.94	23.23	26.76	48.41
Bent 30cm*30cm ground plane centre	36.88	50.90	48.88	50.74	57.96	54.71	56.53	53.72	21.16	23.06	27.6	49.21
Straight 30cm*30cm ground plane Edge	63.69	71.13	73.66	64.61	61.68	53.05	52.27	44.79	18.08	19.03	27.9	45.78
Bent 30cm*30cm ground plane Edge	59.45	74.78	72.18	62.33	59.22	50.68	51.98	41.89	18.72	19	22.27	43.44
Average Gain (dB)												
Bent Free Space	-2.03	-0.83	-1.36	-1.32	-1.25	-1.8	-1.89	-2.67	-6.03	-6.13	-5.54	-2.26
Straight Free Space	-1.93	-1.03	-1.29	-1.59	-1.37	-1.9	-2.01	-3.11	-6.14	-6.1	-5.53	-2.31
Straight 30cm*30cm ground plane centre	-2.01	-1.06	-1.23	-1.97	-1.86	-2.53	-2.45	-2.79	-6.59	-6.37	-5.76	-3.15
Bent 30cm*30cm ground plane centre	-4.33	-2.93	-3.11	-2.95	-2.37	-2.62	-2.48	-2.70	-6.75	-6.4	-5.65	-3.08
Straight 30cm*30cm ground plane Edge	-1.96	-1.48	-1.33	-1.90	-2.10	-2.75	-2.82	-3.49	-7.43	-7.22	-6.59	-3.39
Bent 30cm*30cm ground plane Edge	-2.26	-1.26	-1.42	-2.05	-2.28	-2.95	-2.84	-3.78	-7.28	-7.22	-6.6	-3.62
Peak Gain (dBi)												
Bent Free Space	1.68	2.73	2.16	2.14	3.62	3.5	3.7	2.8	-0.31	0.14	1.02	3.02
Straight Free Space	1.82	1.5	1.63	1.88	3.21	2.91	2.69	1.55	-0.61	-0.28	0.53	2.25
Straight 30cm*30cm ground plane centre	3.56	3.56	3.40	1.75	3.26	2.98	3.31	6.73	2.05	2.2	3.02	6.10
Bent 30cm*30cm ground plane centre	2.30	3.39	3.39	5.34	6.48	5.99	5.78	6.97	1.85	1.24	2.2	6.02
Straight 30cm*30cm ground plane Edge	1.99	2.62	2.55	2.23	3.25	2.60	2.64	2.37	-0.67	-0.93	0.01	2.24
Bent 30cm*30cm ground plane Edge	2.86	3.11	2.98	2.40	3.54	3.18	3.53	5.11	1.88	1.4	1.62	3.30

Impedance	50Ω
Polarization	Linear
Radiation Pattern	Omni
Max. input power	5W

Mechanical

Casing	UV Resistant PC/ABS
Connector	SMA Male Hinged 90°
Weight	75g
Recommended Torque for Mounting	0.9 N·m
Max torque for Mounting	1.176 N·m

Environmental

Temperature Range	-40°C to 85°C
Humidity	Non-condensing 65°C 95% RH

2.1 5G/4G Bands straight in free space

5G/4G Bands			
Band Number	5G / FR1 / LTE / LTE-Advanced / WCDMA / HSPA / HSPA+ / TD-SCDMA		
	Uplink	Downlink	Covered
1	UL: 1920 to 1980	DL: 2110 to 2170	✓
2	UL: 1850 to 1910	DL: 1930 to 1990	✓
3	UL: 1710 to 1785	DL: 1805 to 1880	✓
4	UL: 1710 to 1755	DL: 2110 to 2155	✓
5	UL: 824 to 849	DL: 869 to 894	✓
7	UL: 2500 to 2570	DL: 2620 to 2690	✓
8	UL: 880 to 915	DL: 925 to 960	✓
9	UL: 1749.9 to 1784.9	DL: 1844.9 to 1879.9	✓
11	UL: 1427.9 to 1447.9	DL: 1475.9 to 1495.9	✓
12	UL: 699 to 716	DL: 729 to 746	✓
13	UL: 777 to 787	DL: 746 to 756	✓
14	UL: 788 to 798	DL: 758 to 768	✓
17	UL: 704 to 716	DL: 734 to 746 (LTE only)	✓
18	UL: 815 to 830	DL: 860 to 875 (LTE only)	✓
19	UL: 830 to 845	DL: 875 to 890	✓
20	UL: 832 to 862	DL: 791 to 821	✓
21	UL: 1447.9 to 1462.9	DL: 1495.9 to 1510.9	✓
22	UL: 3410 to 3490	DL: 3510 to 3590	✓
23	UL: 2000 to 2020	DL: 2180 to 2200 (LTE only)	✓
24	UL: 1625.5 to 1660.5	DL: 1525 to 1559 (LTE only)	✓
25	UL: 1850 to 1915	DL: 1930 to 1995	✓
26	UL: 814 to 849	DL: 859 to 894	✓
27	UL: 807 to 824	DL: 852 to 869 (LTE only)	✓
28	UL: 703 to 748	DL: 758 to 803 (LTE only)	✓
29	UL: -	DL: 717 to 728 (LTE only)	✓
30	UL: 2305 to 2315	DL: 2350 to 2360 (LTE only)	✓
31	UL: 452.5 to 457.5	DL: 462.5 to 467.5 (LTE only)	✗
32	UL: -	DL: 1452 - 1496	✓
35		1850 to 1910	✓
38		2570 to 2620	✓
39		1880 to 1920	✓
40		2300 to 2400	✓
41		2496 to 2690	✓
42		3400 to 3600	✓
43		3600 to 3800	✓
48		3550 to 3700	✓
66	UL: 1710-1780	DL: 2110-2200	✓
71		617 to 698	✓
74/75/76		1427 to 1518	✓
78		3300 to 3800	✓
79		4400 to 5000	✓

2.2 5G/4G Bands bent 90 degrees in free space

5G/4G Bands			
Band Number	5G / FR1 / LTE / LTE-Advanced / WCDMA / HSPA / HSPA+ / TD-SCDMA		
	Uplink	Downlink	Covered
1	UL: 1920 to 1980	DL: 2110 to 2170	✓
2	UL: 1850 to 1910	DL: 1930 to 1990	✓
3	UL: 1710 to 1785	DL: 1805 to 1880	✓
4	UL: 1710 to 1755	DL: 2110 to 2155	✓
5	UL: 824 to 849	DL: 869 to 894	✓
7	UL: 2500 to 2570	DL: 2620 to 2690	✓
8	UL: 880 to 915	DL: 925 to 960	✓
9	UL: 1749.9 to 1784.9	DL: 1844.9 to 1879.9	✓
11	UL: 1427.9 to 1447.9	DL: 1475.9 to 1495.9	✓
12	UL: 699 to 716	DL: 729 to 746	✓
13	UL: 777 to 787	DL: 746 to 756	✓
14	UL: 788 to 798	DL: 758 to 768	✓
17	UL: 704 to 716	DL: 734 to 746 (LTE only)	✓
18	UL: 815 to 830	DL: 860 to 875 (LTE only)	✓
19	UL: 830 to 845	DL: 875 to 890	✓
20	UL: 832 to 862	DL: 791 to 821	✓
21	UL: 1447.9 to 1462.9	DL: 1495.9 to 1510.9	✓
22	UL: 3410 to 3490	DL: 3510 to 3590	✓
23	UL: 2000 to 2020	DL: 2180 to 2200 (LTE only)	✓
24	UL: 1625.5 to 1660.5	DL: 1525 to 1559 (LTE only)	✓
25	UL: 1850 to 1915	DL: 1930 to 1995	✓
26	UL: 814 to 849	DL: 859 to 894	✓
27	UL: 807 to 824	DL: 852 to 869 (LTE only)	✓
28	UL: 703 to 748	DL: 758 to 803 (LTE only)	✓
29	UL: -	DL: 717 to 728 (LTE only)	✓
30	UL: 2305 to 2315	DL: 2350 to 2360 (LTE only)	✓
31	UL: 452.5 to 457.5	DL: 462.5 to 467.5 (LTE only)	✗
32	UL: -	DL: 1452 - 1496	✓
35		1850 to 1910	✓
38		2570 to 2620	✓
39		1880 to 1920	✓
40		2300 to 2400	✓
41		2496 to 2690	✓
42		3400 to 3600	✓
43		3600 to 3800	✓
48		3550 to 3700	✓
66	UL: 1710-1780	DL: 2110-2200	✓
71		617 to 698	✓
74/75/76		1427 to 1518	✓
78		3300 to 3800	✓
79		4400 to 5000	✓

2.3 5G/4G Bands Straight 30cm*30cm ground plane Centre

5G/4G Bands			
Band Number	5G / FR1 / LTE / LTE-Advanced / WCDMA / HSPA / HSPA+ / TD-SCDMA		
	Uplink	Downlink	Covered
1	UL: 1920 to 1980	DL: 2110 to 2170	✓
2	UL: 1850 to 1910	DL: 1930 to 1990	✓
3	UL: 1710 to 1785	DL: 1805 to 1880	✓
4	UL: 1710 to 1755	DL: 2110 to 2155	✓
5	UL: 824 to 849	DL: 869 to 894	✓
7	UL: 2500 to 2570	DL: 2620 to 2690	✓
8	UL: 880 to 915	DL: 925 to 960	✓
9	UL: 1749.9 to 1784.9	DL: 1844.9 to 1879.9	✓
11	UL: 1427.9 to 1447.9	DL: 1475.9 to 1495.9	✓
12	UL: 699 to 716	DL: 729 to 746	✓
13	UL: 777 to 787	DL: 746 to 756	✓
14	UL: 788 to 798	DL: 758 to 768	✓
17	UL: 704 to 716	DL: 734 to 746 (LTE only)	✓
18	UL: 815 to 830	DL: 860 to 875 (LTE only)	✓
19	UL: 830 to 845	DL: 875 to 890	✓
20	UL: 832 to 862	DL: 791 to 821	✓
21	UL: 1447.9 to 1462.9	DL: 1495.9 to 1510.9	✓
22	UL: 3410 to 3490	DL: 3510 to 3590	✓
23	UL: 2000 to 2020	DL: 2180 to 2200 (LTE only)	✓
24	UL: 1625.5 to 1660.5	DL: 1525 to 1559 (LTE only)	✓
25	UL: 1850 to 1915	DL: 1930 to 1995	✓
26	UL: 814 to 849	DL: 859 to 894	✓
27	UL: 807 to 824	DL: 852 to 869 (LTE only)	✓
28	UL: 703 to 748	DL: 758 to 803 (LTE only)	✓
29	UL: -	DL: 717 to 728 (LTE only)	✓
30	UL: 2305 to 2315	DL: 2350 to 2360 (LTE only)	✓
31	UL: 452.5 to 457.5	DL: 462.5 to 467.5 (LTE only)	✗
32	UL: -	DL: 1452 - 1496	✓
35		1850 to 1910	✓
38		2570 to 2620	✓
39		1880 to 1920	✓
40		2300 to 2400	✓
41		2496 to 2690	✓
42		3400 to 3600	✓
43		3600 to 3800	✓
48		3550 to 3700	✓
66	UL: 1710-1780	DL: 2110-2200	✓
71		617 to 698	✓
74/75/76		1427 to 1518	✓
78		3300 to 3800	✓
79		4400 to 5000	✓

2.4 5G/4G Bands Bent 30cm*30cm ground plane Centre

5G/4G Bands			
Band Number	5G / FR1 / LTE / LTE-Advanced / WCDMA / HSPA / HSPA+ / TD-SCDMA		
	Uplink	Downlink	Covered
1	UL: 1920 to 1980	DL: 2110 to 2170	✓
2	UL: 1850 to 1910	DL: 1930 to 1990	✓
3	UL: 1710 to 1785	DL: 1805 to 1880	✓
4	UL: 1710 to 1755	DL: 2110 to 2155	✓
5	UL: 824 to 849	DL: 869 to 894	✓
7	UL: 2500 to 2570	DL: 2620 to 2690	✓
8	UL: 880 to 915	DL: 925 to 960	✓
9	UL: 1749.9 to 1784.9	DL: 1844.9 to 1879.9	✓
11	UL: 1427.9 to 1447.9	DL: 1475.9 to 1495.9	✓
12	UL: 699 to 716	DL: 729 to 746	✓
13	UL: 777 to 787	DL: 746 to 756	✓
14	UL: 788 to 798	DL: 758 to 768	✓
17	UL: 704 to 716	DL: 734 to 746 (LTE only)	✓
18	UL: 815 to 830	DL: 860 to 875 (LTE only)	✓
19	UL: 830 to 845	DL: 875 to 890	✓
20	UL: 832 to 862	DL: 791 to 821	✓
21	UL: 1447.9 to 1462.9	DL: 1495.9 to 1510.9	✓
22	UL: 3410 to 3490	DL: 3510 to 3590	✓
23	UL: 2000 to 2020	DL: 2180 to 2200 (LTE only)	✓
24	UL: 1625.5 to 1660.5	DL: 1525 to 1559 (LTE only)	✓
25	UL: 1850 to 1915	DL: 1930 to 1995	✓
26	UL: 814 to 849	DL: 859 to 894	✓
27	UL: 807 to 824	DL: 852 to 869 (LTE only)	✓
28	UL: 703 to 748	DL: 758 to 803 (LTE only)	✓
29	UL: -	DL: 717 to 728 (LTE only)	✓
30	UL: 2305 to 2315	DL: 2350 to 2360 (LTE only)	✓
31	UL: 452.5 to 457.5	DL: 462.5 to 467.5 (LTE only)	✗
32	UL: -	DL: 1452 - 1496	✓
35		1850 to 1910	✓
38		2570 to 2620	✓
39		1880 to 1920	✓
40		2300 to 2400	✓
41		2496 to 2690	✓
42		3400 to 3600	✓
43		3600 to 3800	✓
48		3550 to 3700	✓
66	UL: 1710-1780	DL: 2110-2200	✓
71		617 to 698	✓
74/75/76		1427 to 1518	✓
78		3300 to 3800	✓
79		4400 to 5000	✓

2.5 5G/4G Bands Straight 30cm*30cm ground plane Edge

5G/4G Bands			
Band Number	5G / FR1 / LTE / LTE-Advanced / WCDMA / HSPA / HSPA+ / TD-SCDMA		
	Uplink	Downlink	Covered
1	UL: 1920 to 1980	DL: 2110 to 2170	✓
2	UL: 1850 to 1910	DL: 1930 to 1990	✓
3	UL: 1710 to 1785	DL: 1805 to 1880	✓
4	UL: 1710 to 1755	DL: 2110 to 2155	✓
5	UL: 824 to 849	DL: 869 to 894	✓
7	UL: 2500 to 2570	DL: 2620 to 2690	✓
8	UL: 880 to 915	DL: 925 to 960	✓
9	UL: 1749.9 to 1784.9	DL: 1844.9 to 1879.9	✓
11	UL: 1427.9 to 1447.9	DL: 1475.9 to 1495.9	✓
12	UL: 699 to 716	DL: 729 to 746	✓
13	UL: 777 to 787	DL: 746 to 756	✓
14	UL: 788 to 798	DL: 758 to 768	✓
17	UL: 704 to 716	DL: 734 to 746 (LTE only)	✓
18	UL: 815 to 830	DL: 860 to 875 (LTE only)	✓
19	UL: 830 to 845	DL: 875 to 890	✓
20	UL: 832 to 862	DL: 791 to 821	✓
21	UL: 1447.9 to 1462.9	DL: 1495.9 to 1510.9	✓
22	UL: 3410 to 3490	DL: 3510 to 3590	✓
23	UL: 2000 to 2020	DL: 2180 to 2200 (LTE only)	✓
24	UL: 1625.5 to 1660.5	DL: 1525 to 1559 (LTE only)	✓
25	UL: 1850 to 1915	DL: 1930 to 1995	✓
26	UL: 814 to 849	DL: 859 to 894	✓
27	UL: 807 to 824	DL: 852 to 869 (LTE only)	✓
28	UL: 703 to 748	DL: 758 to 803 (LTE only)	✓
29	UL: -	DL: 717 to 728 (LTE only)	✓
30	UL: 2305 to 2315	DL: 2350 to 2360 (LTE only)	✓
31	UL: 452.5 to 457.5	DL: 462.5 to 467.5 (LTE only)	✗
32	UL: -	DL: 1452 - 1496	✓
35		1850 to 1910	✓
38		2570 to 2620	✓
39		1880 to 1920	✓
40		2300 to 2400	✓
41		2496 to 2690	✓
42		3400 to 3600	✓
43		3600 to 3800	✓
48		3550 to 3700	✓
66	UL: 1710-1780	DL: 2110-2200	✓
71		617 to 698	✓
74/75/76		1427 to 1518	✓
78		3300 to 3800	✓
79		4400 to 5000	✓

2.6 5G/4G Bands Bent 30cm*30cm ground plane Edge

5G/4G Bands			
Band Number	5G / FR1 / LTE / LTE-Advanced / WCDMA / HSPA / HSPA+ / TD-SCDMA		
	Uplink	Downlink	Covered
1	UL: 1920 to 1980	DL: 2110 to 2170	✓
2	UL: 1850 to 1910	DL: 1930 to 1990	✓
3	UL: 1710 to 1785	DL: 1805 to 1880	✓
4	UL: 1710 to 1755	DL: 2110 to 2155	✓
5	UL: 824 to 849	DL: 869 to 894	✓
7	UL: 2500 to 2570	DL: 2620 to 2690	✓
8	UL: 880 to 915	DL: 925 to 960	✓
9	UL: 1749.9 to 1784.9	DL: 1844.9 to 1879.9	✓
11	UL: 1427.9 to 1447.9	DL: 1475.9 to 1495.9	✓
12	UL: 699 to 716	DL: 729 to 746	✓
13	UL: 777 to 787	DL: 746 to 756	✓
14	UL: 788 to 798	DL: 758 to 768	✓
17	UL: 704 to 716	DL: 734 to 746 (LTE only)	✓
18	UL: 815 to 830	DL: 860 to 875 (LTE only)	✓
19	UL: 830 to 845	DL: 875 to 890	✓
20	UL: 832 to 862	DL: 791 to 821	✓
21	UL: 1447.9 to 1462.9	DL: 1495.9 to 1510.9	✓
22	UL: 3410 to 3490	DL: 3510 to 3590	✓
23	UL: 2000 to 2020	DL: 2180 to 2200 (LTE only)	✓
24	UL: 1625.5 to 1660.5	DL: 1525 to 1559 (LTE only)	✓
25	UL: 1850 to 1915	DL: 1930 to 1995	✓
26	UL: 814 to 849	DL: 859 to 894	✓
27	UL: 807 to 824	DL: 852 to 869 (LTE only)	✓
28	UL: 703 to 748	DL: 758 to 803 (LTE only)	✓
29	UL: -	DL: 717 to 728 (LTE only)	✓
30	UL: 2305 to 2315	DL: 2350 to 2360 (LTE only)	✓
31	UL: 452.5 to 457.5	DL: 462.5 to 467.5 (LTE only)	✗
32	UL: -	DL: 1452 - 1496	✓
35		1850 to 1910	✓
38		2570 to 2620	✓
39		1880 to 1920	✓
40		2300 to 2400	✓
41		2496 to 2690	✓
42		3400 to 3600	✓
43		3600 to 3800	✓
48		3550 to 3700	✓
66	UL: 1710-1780	DL: 2110-2200	✓
71		617 to 698	✓
74/75/76		1427 to 1518	✓
78		3300 to 3800	✓
79		4400 to 5000	✓

3. Antenna Characteristics

3.1 Test Setup

In Free Space

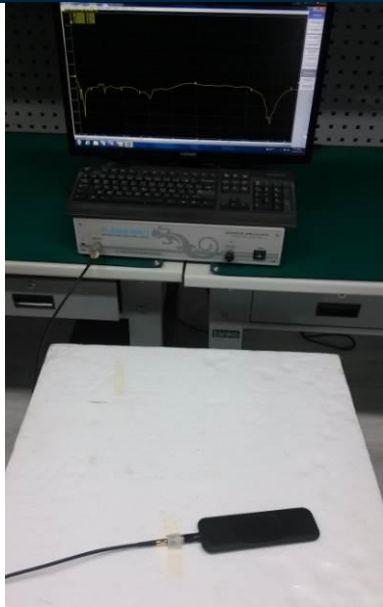

Antenna straight

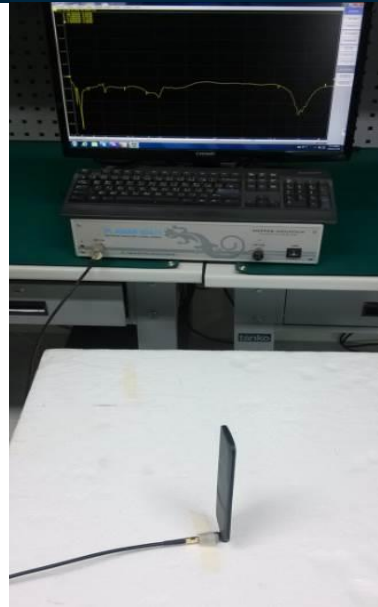

Antenna bent 90°

On 30cm*30cm ground plane Centre

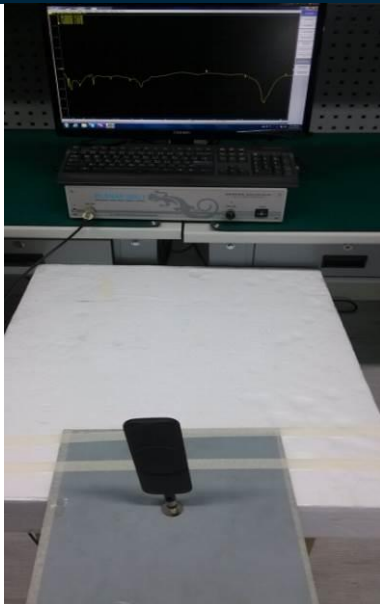

Antenna straight

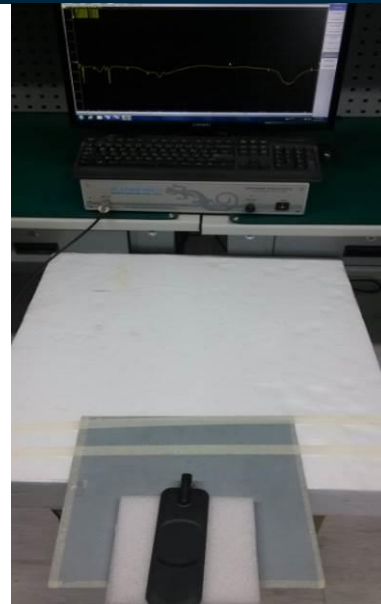

Antenna bent 90°

On 30cm*30cm ground plane Edge

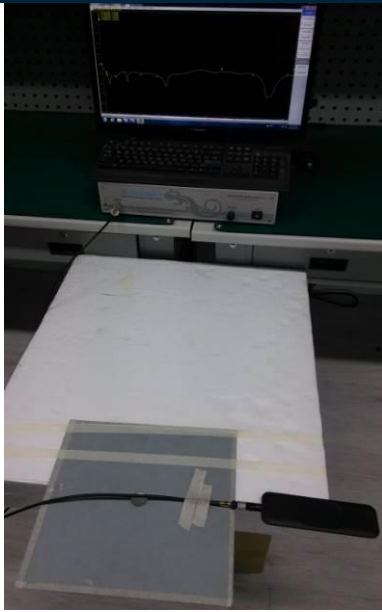

Antenna straight



Antenna bent 90°

3.2 Return Loss

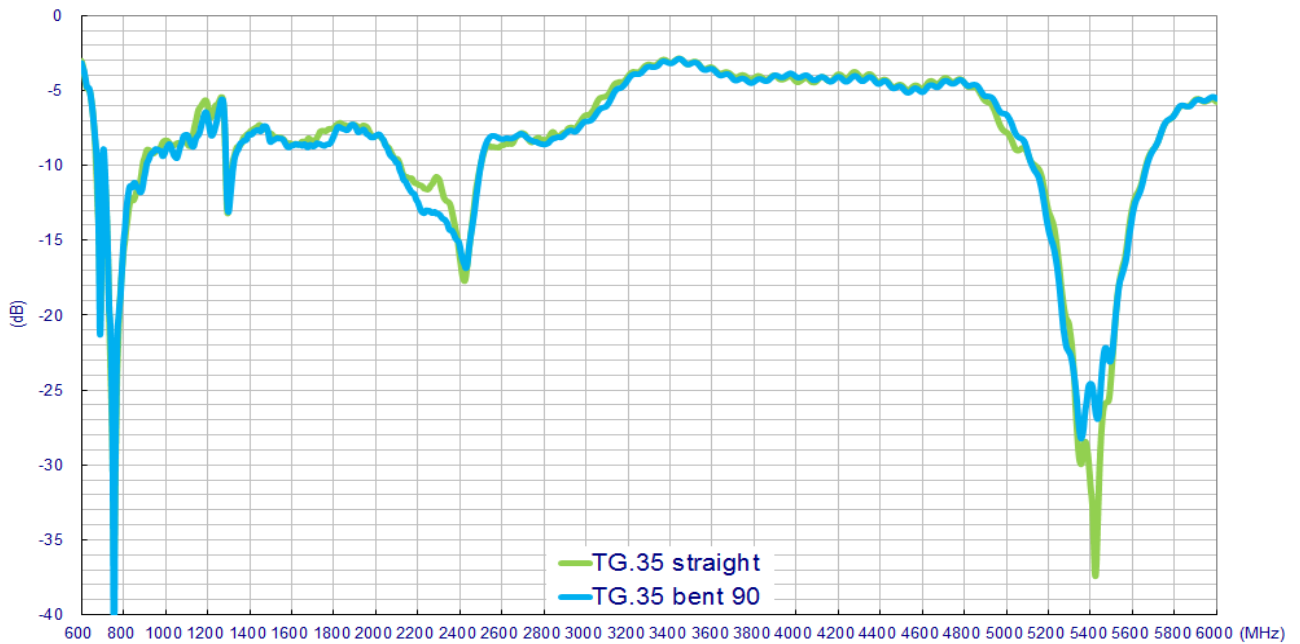

In Free Space

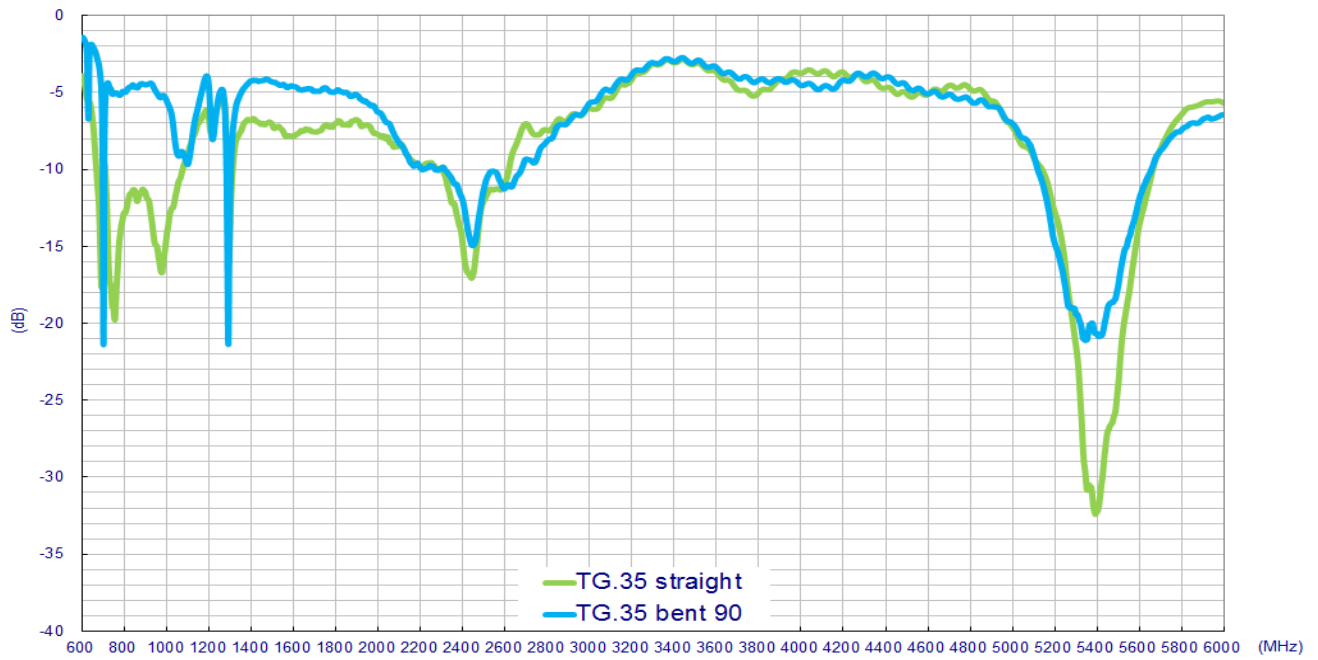

On 30*30cm ground plane centre

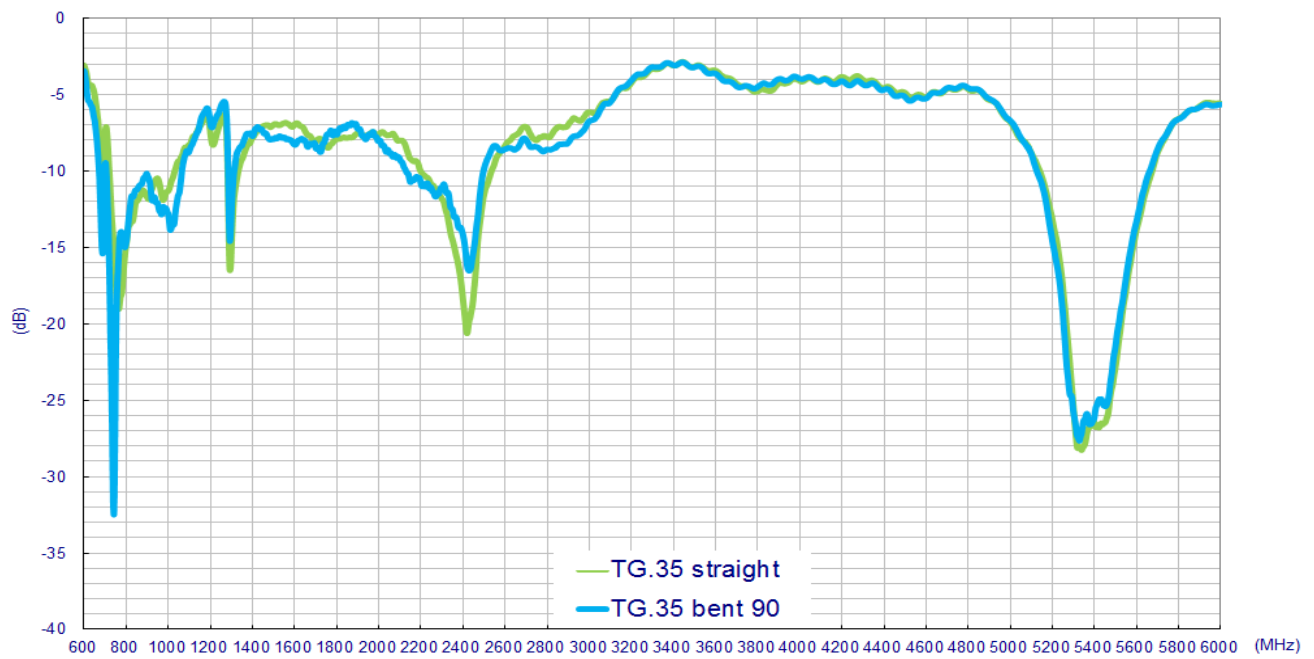

On 30*30cm ground plane edge

3.3 Peak Gain

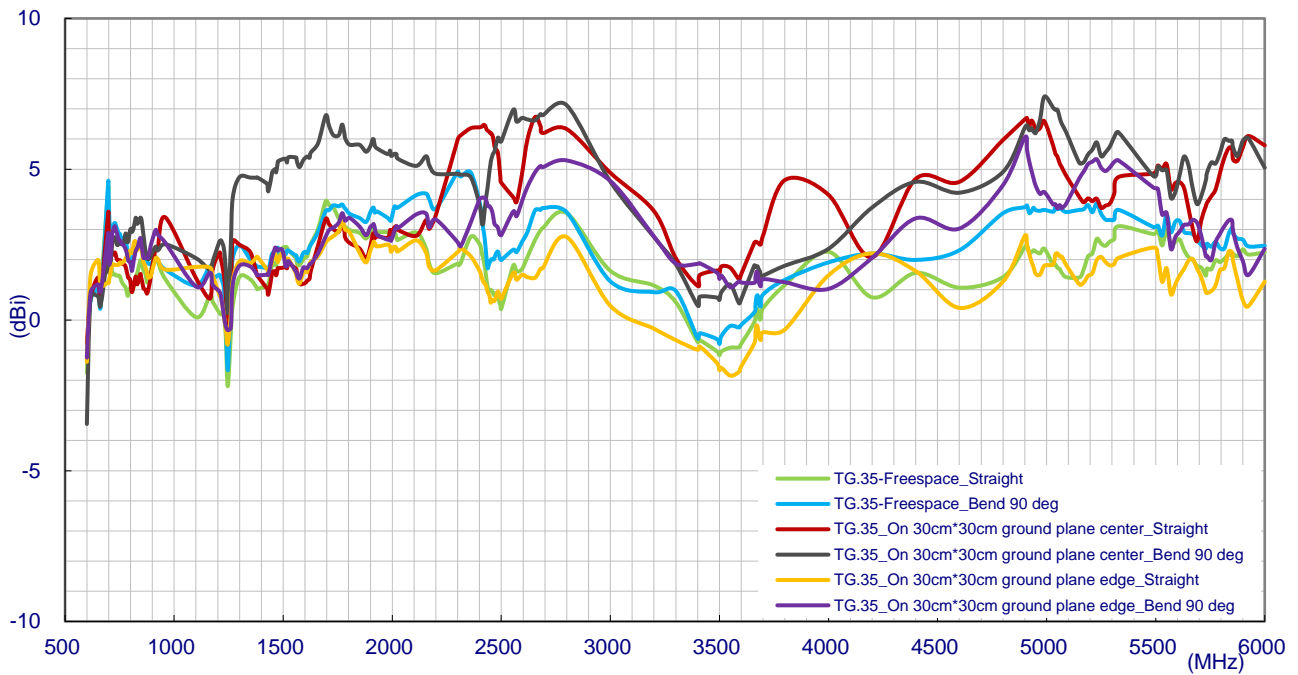

3.5 Efficiency

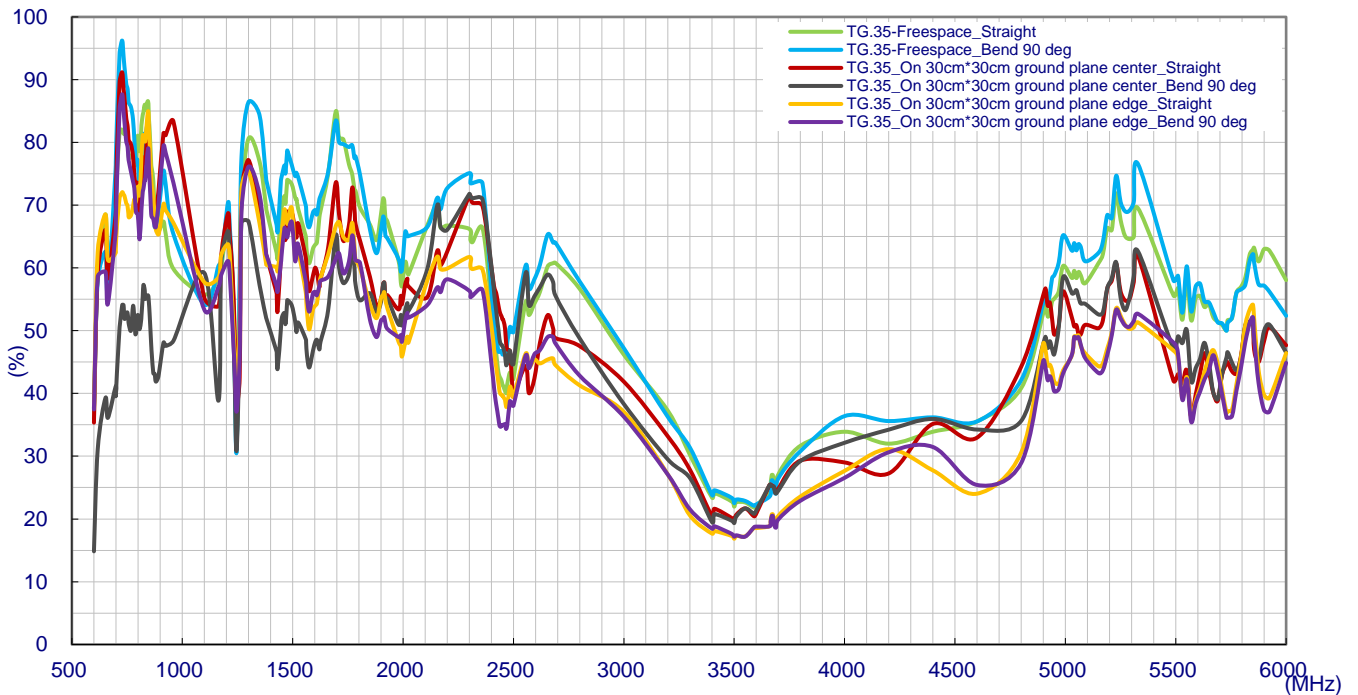

3.5 Average Gain

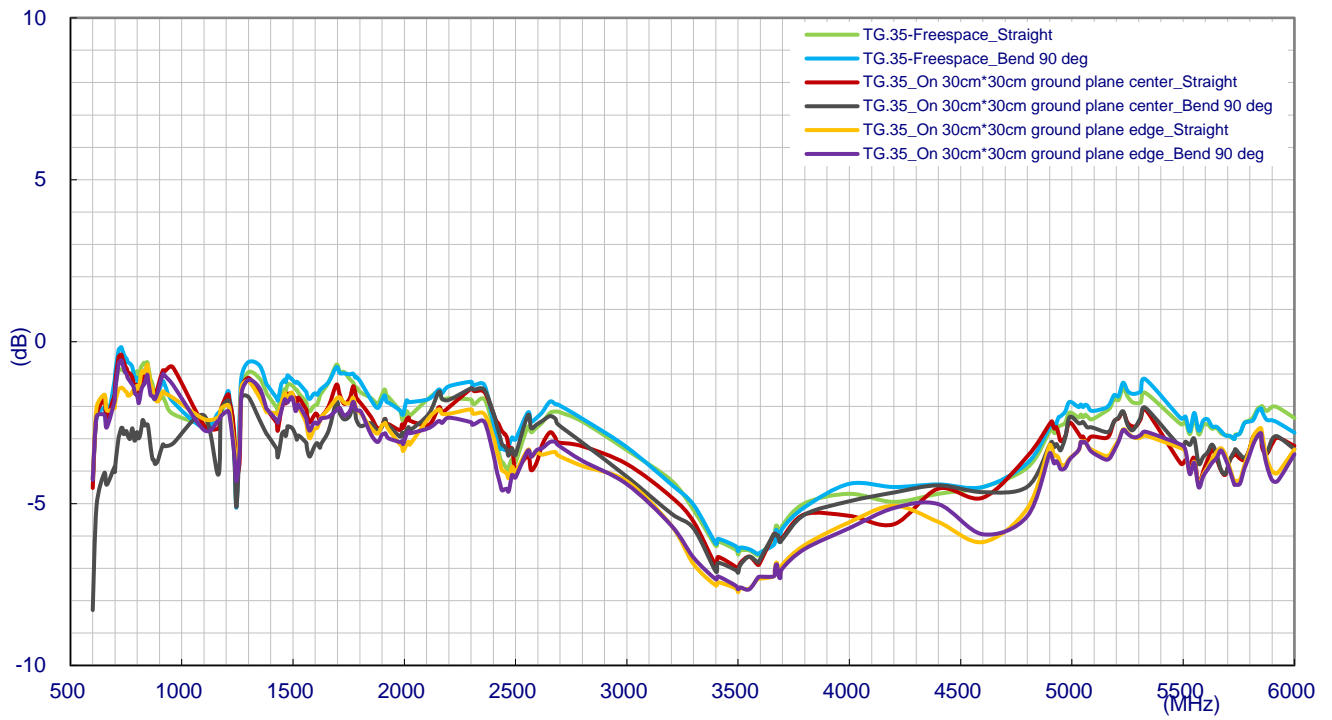

4. 2D Radiation Patterns

4.1 Antenna Test Setup

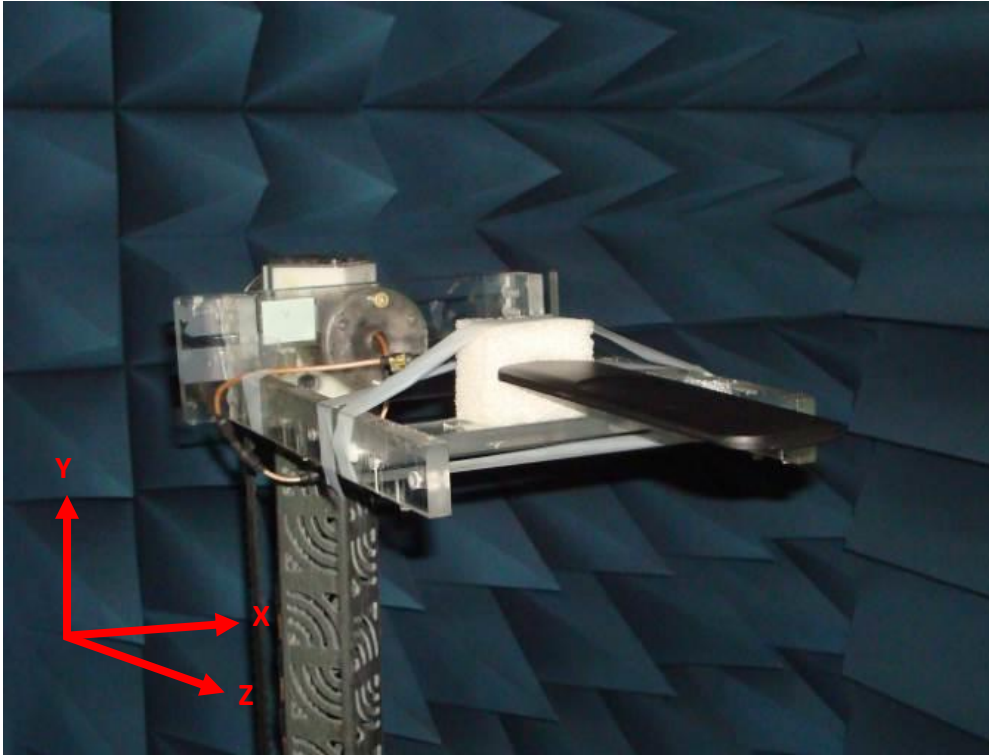

Antenna straight in free space

4.2 2D Radiation Patterns

4.2.1 Antenna straight in free space

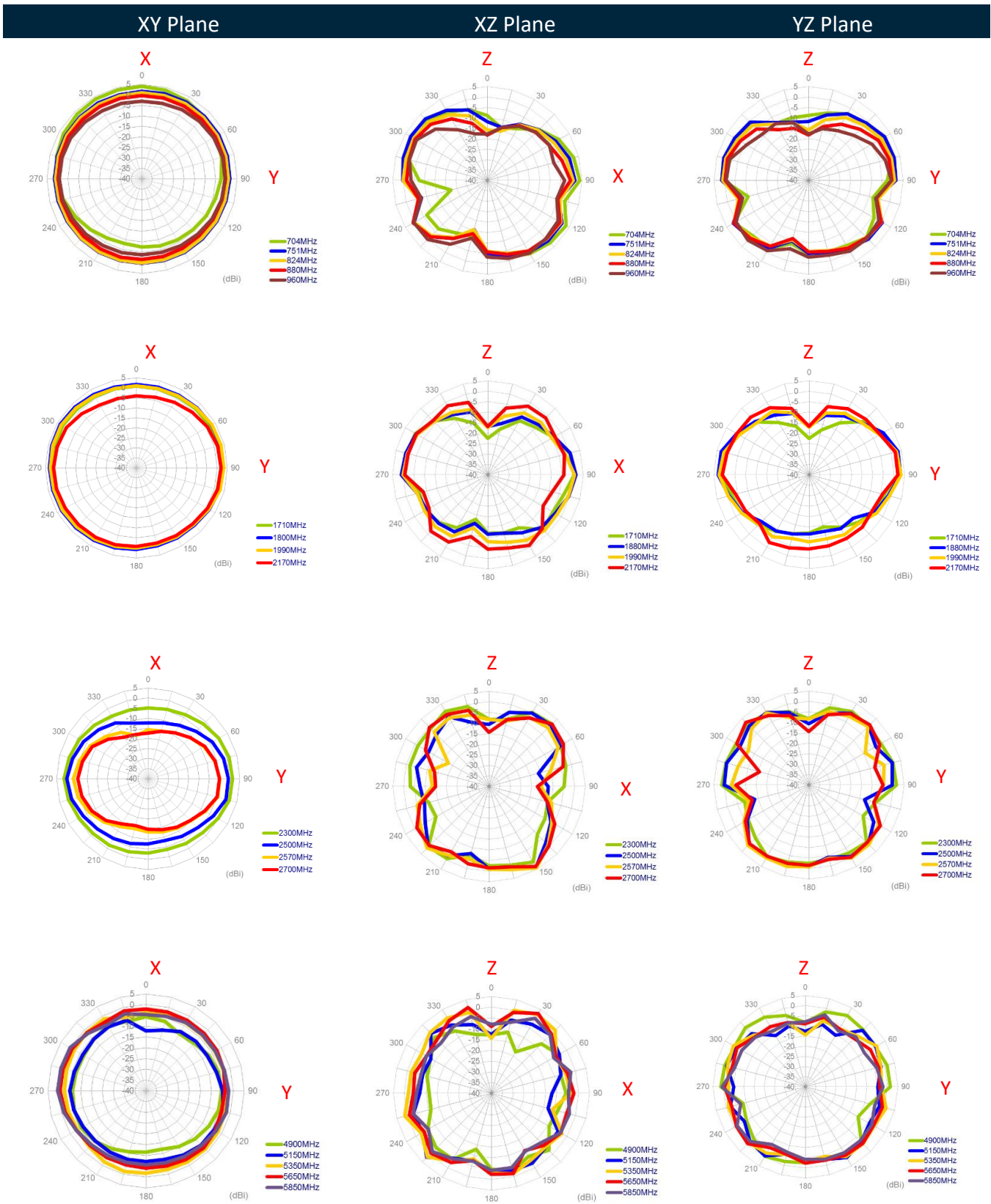

4.3 Antenna Test Setup

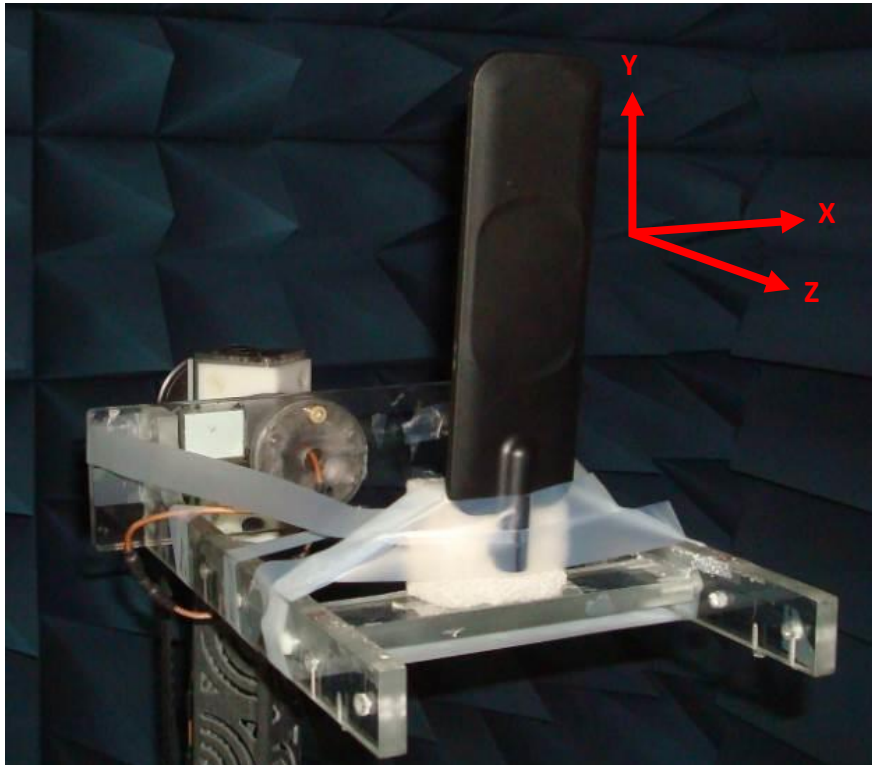

Antenna bent 90° in free space

4.4 2D Radiation Patterns

4.4.1 Antenna bent 90° in free space

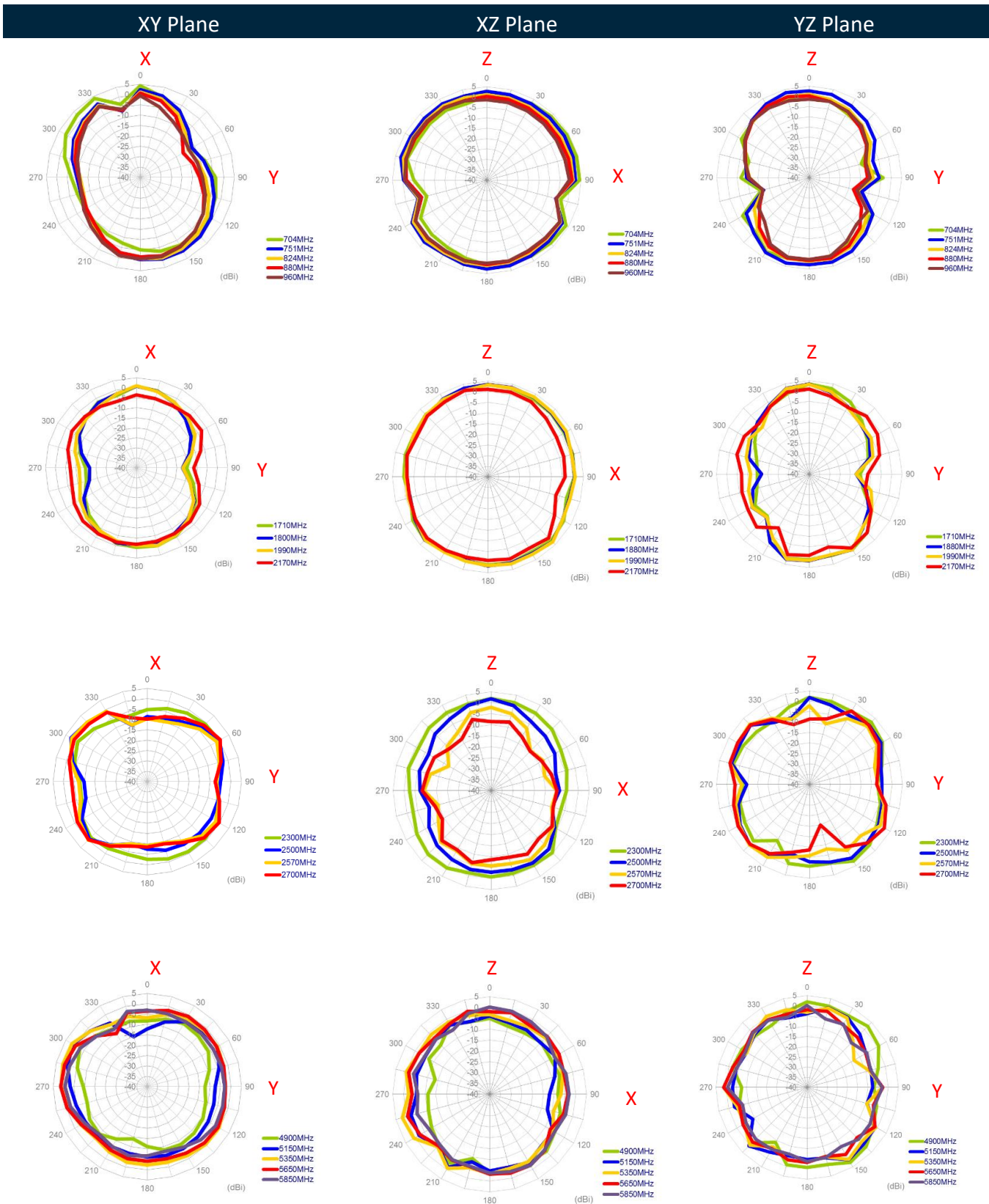

4.5 Antenna Test Setup

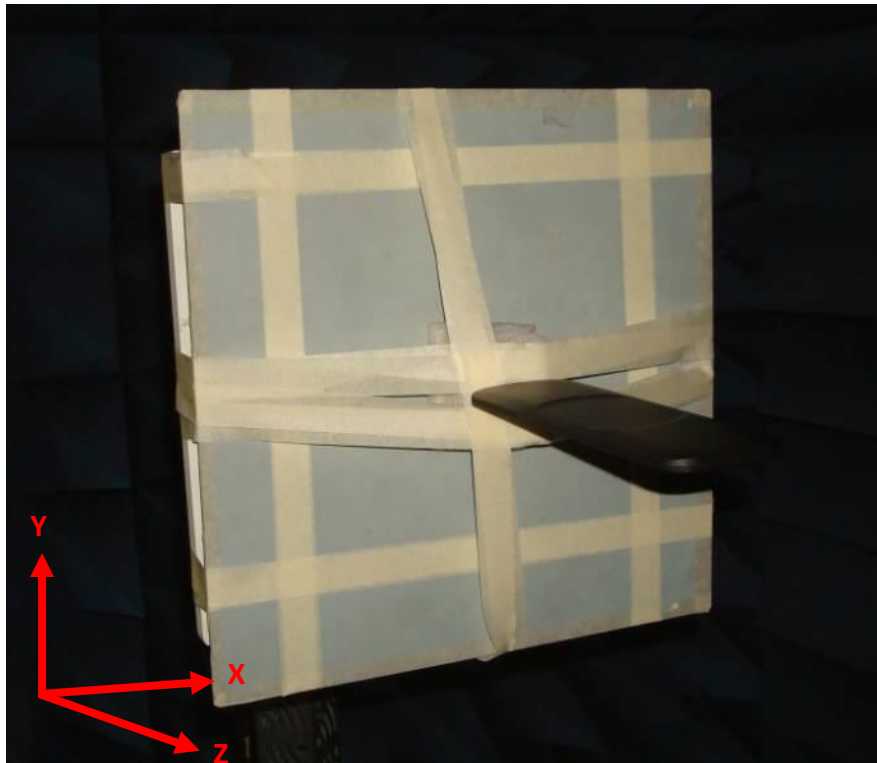

Antenna straight with 30x30cm ground plane center

4.6 2D Radiation Patterns

4.10.1 Antenna straight with 30x30cm ground plane center

XY Plane XZ Plane YZ Plane

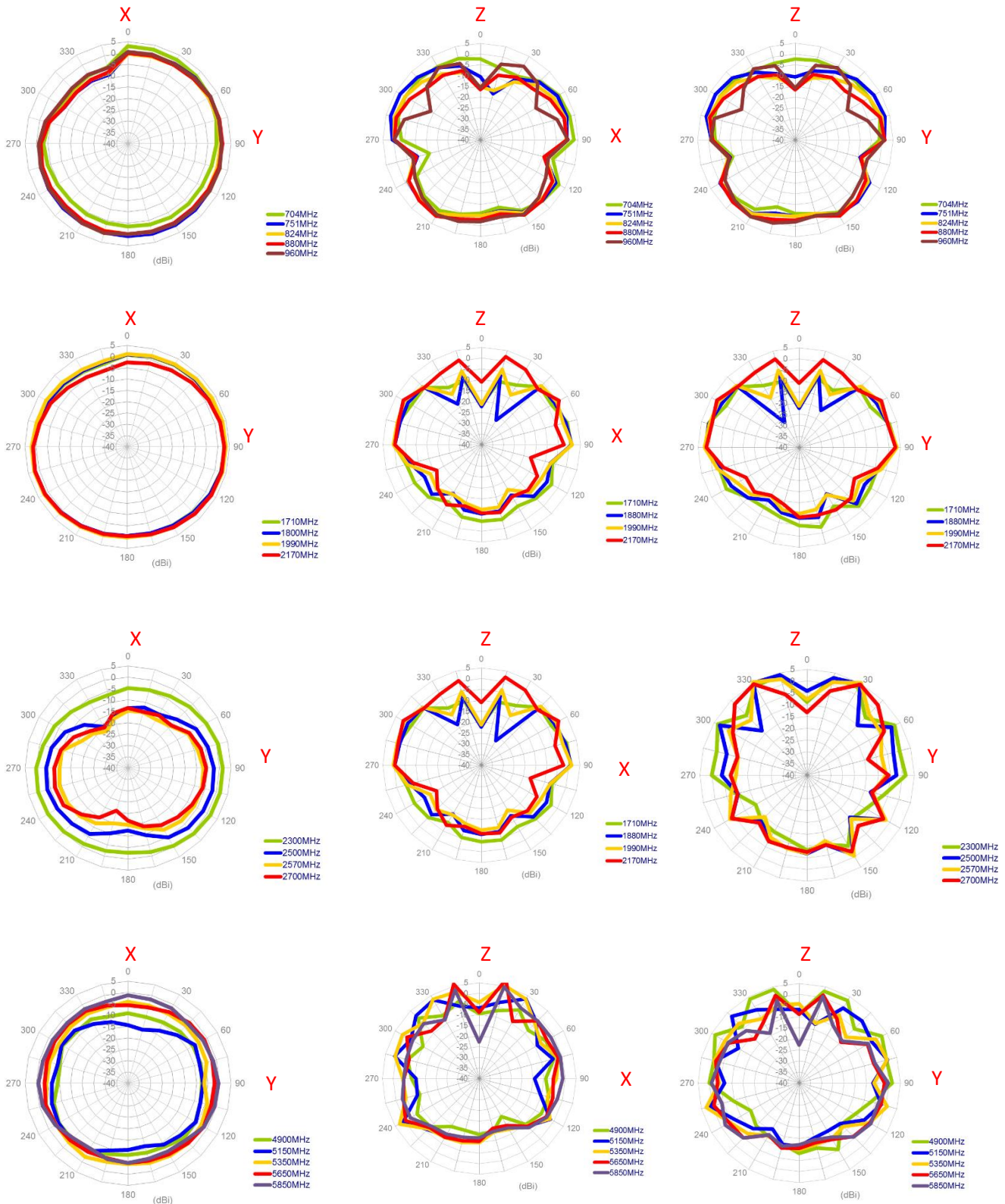

5. Installation

TG.35/45 Installation Instructions

The TG.35/45 antenna has an independent rotating SMA connector, which enables users to install the antenna in a preferable direction. After tightening the SMA connector, the antenna will sit firmly on users' base/router either on a table or on a wall. This installation sheet illustrates using the TG.35/45 on a wall mounted device as an example.

Step 1.

Adjust the antenna to preferable direction, then mount the SMA(M) connector on devices SMA(F) connector. (See figure 1)

Step 2.

Hold the antenna housing with one hand, while rotating the SMA(M) connector with the other hand until the connector is tight. If the connector was tightened properly, the antenna will keep its position without slipping down. (See figure 2)

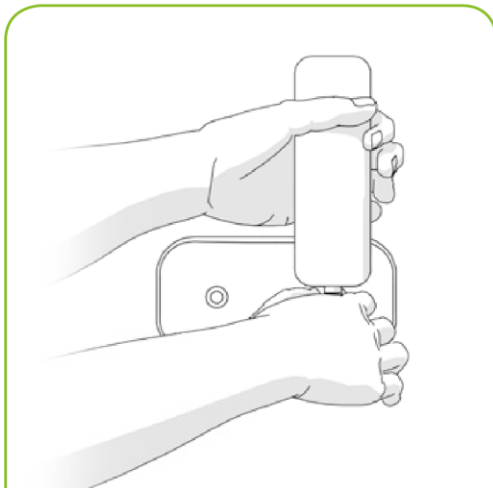

Figure 1. Place the TG.35/45 antenna onto the connector of the device and hold the antenna in the preferred orientation.

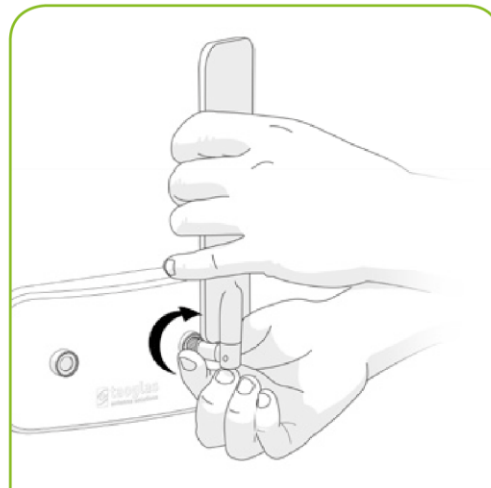
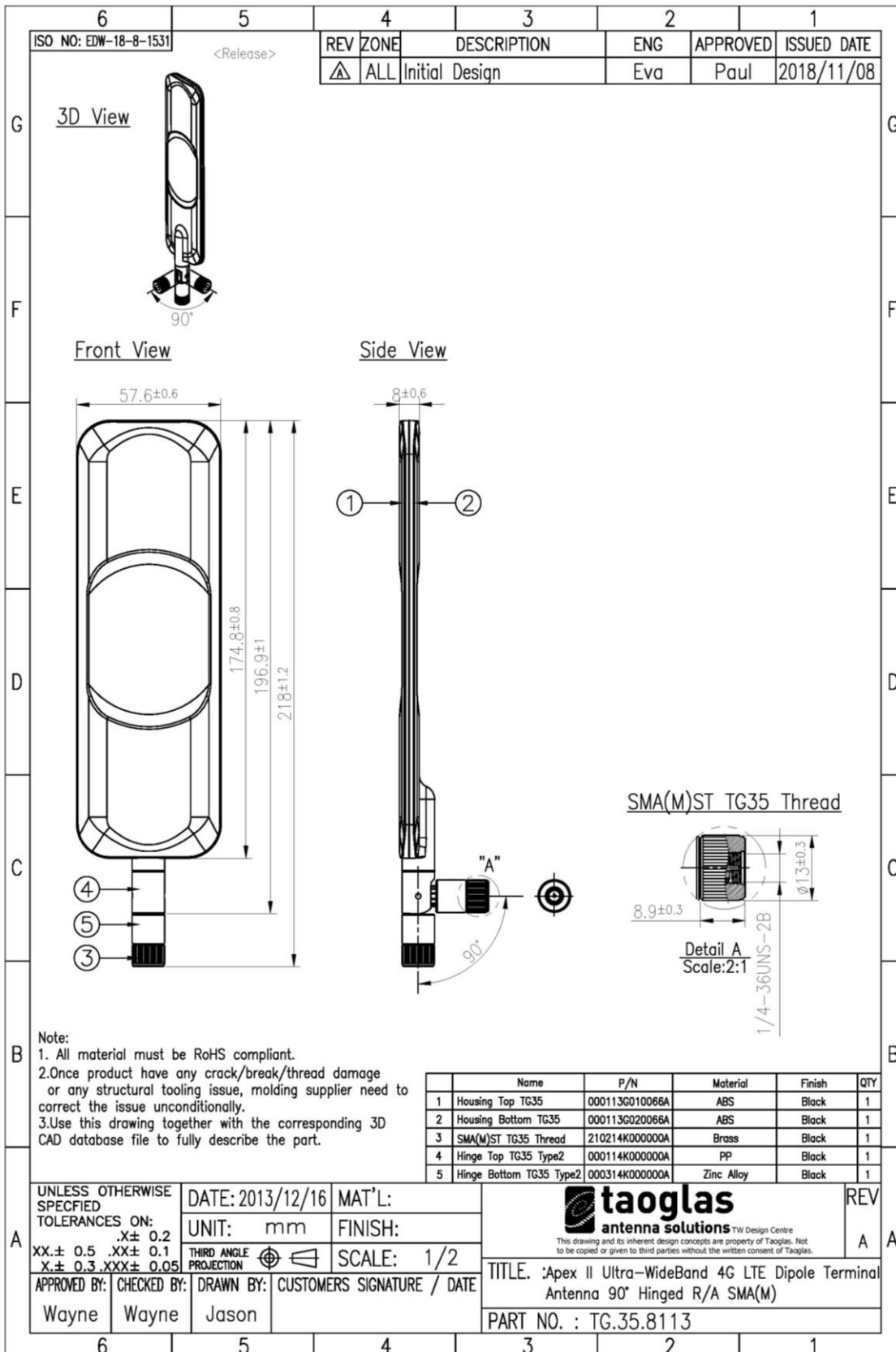

Figure 2. Fix the connector to the device by twisting the rotating head of the SMA connector until it is tight enough to hold the antenna in the correct position.

www.taoglas.com/tg35-tg45-installation-instructions/

6. Mechanical Drawing (Units: mm)



7. Packaging

1pc TG.35.8113 per Small PE Bag with Video Link label
 Dimensions: 100*280mm
 Weight: 73.5g



25pcs per Large PE Bag
 Dimensions: 280*430mm
 Weight: 1.85Kg

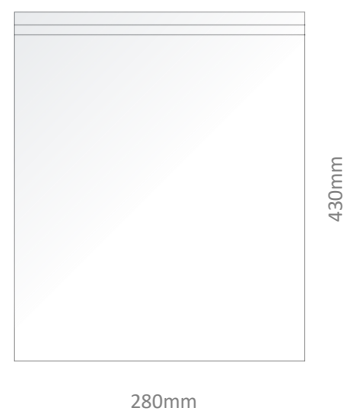

75pcs TG.35.8113 per Carton
 Carton Dimensions: 330*260*300mm
 Weight: 6.1Kg

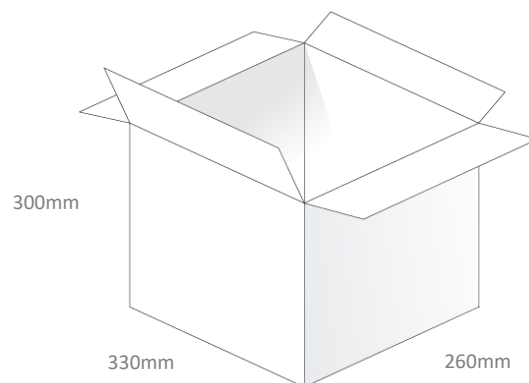

Changelog for the datasheet

SPE-14-8-083 – TG.35.8113

Revision: G (Current Version)

Date:	2019-08-21
Changes:	Updated Test data
Changes Made by:	Jack Conroy

Previous Revisions

Revision: F

Date:	2019-04-19
Changes:	Updated Frequency range
Changes Made by:	Jack Conroy

Revision: A (Original First Release)

Date:	2014-08-22
Notes:	
Author:	Aine Doyle

Revision: E

Date:	2018-12-10
Changes:	Amended Average Gain
Changes Made by:	David Connolly

Revision: D

Date:	2017-03-30
Changes:	Added LTE Table
Changes Made by:	Andy Mahoney

Revision: C

Date:	2015-09-18
Changes:	Updated Hinge
Changes Made by:	Aine Doyle

Revision: B

Date:	2014-09-04
Changes:	Added Note
Changes Made by:	Aine Doyle



TAOGLAS®

www.taoglas.com

