

## SPECIFICATION

Part No.	:	<b>TG.08.0113</b>
Description	:	Monopole Passive Antenna Broadband frequency range for cellular and GNSS
Features	:	High efficiency at 698 to 960MHz, 1561MHz, 1575.42MHz, 1602MHz, 1710 to 2700MHz. 360°rotatable with durable brass hinge. Compatible with: <ul style="list-style-type: none"><li>- 2G ( GSM / DCS / PCS )</li><li>- 3G ( CDMA / WCDMA / UMTS / HSPA )</li><li>- 4G (700LTE / 2700LTE )</li><li>- GNSS ( GPS / GLONASS / Galileo / BeiDou)</li></ul> Standard with SMA(M) connector Low profile with 72 ± 1.5mm Length <b>RoHs Compliant</b>



## 1. Introduction

The compact TG.08 with hinged rotatable SMA connector, is an impressively high efficiency monopole antenna, which provides wide coverage among cellular and GNSS frequencies.

With its cellular and GNSS function, plus compact design, TG.08 can fit and function perfectly with routers, vehicle tracking devices, telematics devices, and remote monitoring systems. It is also ideal for use with cellular modules with Assisted GPS functionality that can be implemented in various devices.

This 72mm long monopole antenna works efficiently from 700MHz to 2700MHz, widely covering 4G/3G/2G bands, as well as GPS/GLONASS/Galileo /BeiDou. At its maximum efficiency when connected to ground plane, it can achieve 73% and 67% at GPS and LTE bands, respectively.

As all monopole antennas, TG.08 works best while connecting directly to the ground-plane of the device main-board, or with the device's metal enclosure.

The robust brass hinge enables TG.08 to be oriented in all directions, providing users to maximize performance with minimum effort.

TG.08, the small antenna with surprisingly large efficiency, is surely the best candidate in the market for Cellular/GNSS combination terminal antennas.

## 2. Specification

Parameter										
Straight Position										
Band	700LTE	GSM	BEIDOU	GPS/ GALILEO	GLONASS	DCS	PCS	UMTS/ HSPA	2700LTE	
Frequency (MHz)	703~ 803	824~ 960	1561	1575.42	1602	1710~ 1880	1850~ 1990	1920~ 2170	2490~ 2690	
Average Gain (dBi)	In Free Space	-9.69	-8.70	-5.77	-5.44	-4.92	-3.84	-3.45	-3.62	-4.39
Efficiency (%)		10.75	13.50	26.48	28.56	32.24	41.40	45.18	43.46	36.73
Peak Gain (dBi)		-6.46	-4.93	-1.42	-1.07	-0.61	-0.02	0.66	0.33	0.36
Return Loss (dB)		< -2	< -3	< -6	< -6	< -10	< -10	< -10	< -8	< 4
Average Gain (dBi)	With 15x9cm Ground	-1.72	-4.35	-1.73	-1.67	-1.54	-1.38	-1.33	-1.70	-1.60
Efficiency (%)		67.86	37.27	67.08	68.13	70.22	72.83	73.67	67.77	69.40
Peak Gain (dBi)		1.24	-1.28	1.99	1.98	1.86	2.48	2.79	2.79	3.25
Return Loss (dB)		< -5		< -8						
Average Gain (dBi)	On 30x30cm Ground Metal Edge	-1.75	-2.55	-1.37	-1.34	-1.37	-1.31	-1.31	-1.70	-2.75
Efficiency (%)		66.98	56.27	73.02	73.38	72.97	74.02	74.05	67.83	53.12
Peak Gain (dBi)		1.53	0.13	3.95	3.86	3.82	2.82	3.22	3.20	2.22
Return Loss (dB)		< -5		< -9						
Average Gain (dBi)	On 30x30cm Ground Metal Center	-4.59	-3.46	-2.79	-2.82	-2.89	-2.71	-2.71	-2.94	-2.65
Efficiency (%)		35.71	45.52	52.63	52.25	51.38	53.68	53.56	50.89	54.39
Peak Gain (dBi)		-0.65	0.77	1.98	1.88	1.61	3.16	2.56	2.33	3.26
Return Loss (dB)		< -2		< -4						
Bent Position										
Average Gain (dBi)	In Free Space	-10.74	-10.14	-5.81	-5.48	-4.99	-4.03	-3.71	-4.00	-4.80
Efficiency (%)		8.44	9.70	26.27	28.29	31.68	39.58	42.60	39.93	33.53
Peak Gain (dBi)		-7.22	-5.54	-1.63	-1.29	-0.75	0.06	0.94	0.69	0.46
Return Loss (dB)		< -2	< -3	< -10	< -10	< -10	< -10	< -10	< -8	< -4
Average Gain (dBi)	With 15x9cm Ground	-1.72	-4.35	-1.73	-1.67	-1.54	-1.38	-1.33	-1.70	-1.60
Efficiency (%)		67.86	37.27	67.08	68.13	70.22	72.83	73.67	67.77	69.40
Peak Gain (dBi)		1.24	-1.28	1.99	1.98	1.86	2.48	2.79	2.79	3.25
Return Loss (dB)		< -5		< -8						

Average Gain (dBi)	On 30x30cm ground Metal Edge	-2.98	-2.87	-1.46	-1.43	-1.42	-1.26	-1.31	-1.81	-3.01
Efficiency (%)		50.73	52.04	71.38	71.90	72.16	74.96	74.01	66.35	50.02
Peak Gain (dBi)		0.74	0.65	3.47	3.51	3.56	3.03	3.56	3.62	2.69
Return Loss (dB)		< -5		< -8						
Average Gain (dBi)	On 30x30cm Ground Metal Center	-8.87	-6.76	-2.61	-2.63	-2.71	-2.80	-3.03	-3.47	-3.29
Efficiency (%)		13.53	21.31	54.89	54.63	53.54	52.53	49.87	45.22	46.93
Peak Gain (dBi)		-4.74	-1.92	1.96	1.89	2.00	3.01	2.26	1.79	2.58
Return Loss (dB)		< -2		< -3						
Radiation	Omni-directional									
Polarization	Linear									
Impedance	50 Ω									
Input Power	10W									
<b>MECHANICAL</b>										
Antenna length	72mm									
Antenna Diameter	10mm									
Casing	POM									
Connector	SMA(M)									
Weight	6g									
Recommended Torque for Mounting	0.9N·m									
Max. Torque for Mounting	1.176N·m									
<b>ENVIRONMENTAL</b>										
Operation Temperature	-40°C ~ + 85°C									
Storage Temperature	-40°C ~ + 85°C									
Humidity	Non-condensing 65°C 95% RH									

## 2.1. LTE Bands – Straight in Free Space

LTE BANDS			
Band Number	LTE / LTE-Advanced / WCDMA / HSPA / HSPA+ / TD-SCDMA		
	Uplink	Downlink	Covered
1	UL: 1920 to 1980	DL: 2110 to 2170	✓
2	UL: 1850 to 1910	DL: 1930 to 1990	✓
3	UL: 1710 to 1785	DL: 1805 to 1880	✓
4	UL: 1710 to 1755	DL: 2110 to 2155	✓
5	UL: 824 to 849	DL: 869 to 894	✗
7	UL: 2500 to 2570	DL: 2620 to 2690	✓
8	UL: 880 to 915	DL: 925 to 960	✗
9	UL: 1749.9 to 1784.9	DL: 1844.9 to 1879.9	✓
11	UL: 1427.9 to 1447.9	DL: 1475.9 to 1495.9	✗
12	UL: 699 to 716	DL: 729 to 746	✗
13	UL: 777 to 787	DL: 746 to 756	✗
14	UL: 788 to 798	DL: 758 to 768	✗
17	UL: 704 to 716	DL: 734 to 746 (LTE only)	✗
18	UL: 815 to 830	DL: 860 to 875 (LET only)	✗
19	UL: 830 to 845	DL: 875 to 890	✗
20	UL: 832 to 862	DL: 791 to 821	✗
21	UL: 1447.9 to 1462.9	DL: 1495.9 to 1510.9	✗
22	UL: 3410 to 3490	DL: 3510 to 3590	✗
23	UL: 2000 to 2020	DL: 2180 to 2200 (LTE only)	✓
24	UL: 1625.5 to 1660.5	DL: 1525 to 1559 (LTE only)	✗
25	UL: 1850 to 1915	DL: 1930 to 1995	✓
26	UL: 814 to 849	DL: 859 to 894	✗
27	UL: 807 to 824	DL: 852 to 869 (LTE only)	✗
28	UL: 703 to 748	DL: 758 to 803 (LTE only)	✗
29	UL: -	DL: 717 to 728 (LTE only)	✓
30	UL: 2305 to 2315	DL: 2350 to 2360 (LTE only)	✓
31	UL: 452.5 to 457.5	DL: 462.5 to 467.5 (LTE only)	✗
32	UL: -	DL: 1452 - 1496	✗
35		1850 to 1910	✓
38		2570 to 2620	✓
39		1880 to 1920	✓
40		2300 to 2400	✓
41		2496 to 2690	✓
42		3400 to 3600	✗
43		3600 to 3800	✗

\*Covered bands represent an efficiency greater than 20%

## 2.2. LTE Bands – Straight on Edge of 300\*300mm Ground Plane

LTE BANDS			
Band Number	LTE / LTE-Advanced / WCDMA / HSPA / HSPA+ / TD-SCDMA		
	Uplink	Downlink	Covered
1	UL: 1920 to 1980	DL: 2110 to 2170	✓
2	UL: 1850 to 1910	DL: 1930 to 1990	✓
3	UL: 1710 to 1785	DL: 1805 to 1880	✓
4	UL: 1710 to 1755	DL: 2110 to 2155	✓
5	UL: 824 to 849	DL: 869 to 894	✓
7	UL: 2500 to 2570	DL: 2620 to 2690	✓
8	UL: 880 to 915	DL: 925 to 960	✓
9	UL: 1749.9 to 1784.9	DL: 1844.9 to 1879.9	✓
11	UL: 1427.9 to 1447.9	DL: 1475.9 to 1495.9	✗
12	UL: 699 to 716	DL: 729 to 746	✓
13	UL: 777 to 787	DL: 746 to 756	✓
14	UL: 788 to 798	DL: 758 to 768	✓
17	UL: 704 to 716	DL: 734 to 746 (LTE only)	✓
18	UL: 815 to 830	DL: 860 to 875 (LTE only)	✓
19	UL: 830 to 845	DL: 875 to 890	✓
20	UL: 832 to 862	DL: 791 to 821	✓
21	UL: 1447.9 to 1462.9	DL: 1495.9 to 1510.9	✗
22	UL: 3410 to 3490	DL: 3510 to 3590	✗
23	UL: 2000 to 2020	DL: 2180 to 2200 (LTE only)	✓
24	UL: 1625.5 to 1660.5	DL: 1525 to 1559 (LTE only)	✓
25	UL: 1850 to 1915	DL: 1930 to 1995	✓
26	UL: 814 to 849	DL: 859 to 894	✓
27	UL: 807 to 824	DL: 852 to 869 (LTE only)	✓
28	UL: 703 to 748	DL: 758 to 803 (LTE only)	✓
29	UL: -	DL: 717 to 728 (LTE only)	✓
30	UL: 2305 to 2315	DL: 2350 to 2360 (LTE only)	✓
31	UL: 452.5 to 457.5	DL: 462.5 to 467.5 (LTE only)	✗
32	UL: -	DL: 1452 - 1496	✗
35		1850 to 1910	✓
38		2570 to 2620	✓
39		1880 to 1920	✓
40		2300 to 2400	✓
41		2496 to 2690	✓
42		3400 to 3600	✗
43		3600 to 3800	✗

\*Covered bands represent an efficiency greater than 20%

## 2.3. LTE Bands – Bent in Free Space

LTE BANDS			
Band Number	LTE / LTE-Advanced / WCDMA / HSPA / HSPA+ / TD-SCDMA		
	Uplink	Downlink	Covered
1	UL: 1920 to 1980	DL: 2110 to 2170	✓
2	UL: 1850 to 1910	DL: 1930 to 1990	✓
3	UL: 1710 to 1785	DL: 1805 to 1880	✓
4	UL: 1710 to 1755	DL: 2110 to 2155	✓
5	UL: 824 to 849	DL: 869 to 894	✗
7	UL: 2500 to 2570	DL: 2620 to 2690	✓
8	UL: 880 to 915	DL: 925 to 960	✗
9	UL: 1749.9 to 1784.9	DL: 1844.9 to 1879.9	✓
11	UL: 1427.9 to 1447.9	DL: 1475.9 to 1495.9	✗
12	UL: 699 to 716	DL: 729 to 746	✗
13	UL: 777 to 787	DL: 746 to 756	✗
14	UL: 788 to 798	DL: 758 to 768	✗
17	UL: 704 to 716	DL: 734 to 746 (LTE only)	✗
18	UL: 815 to 830	DL: 860 to 875 (LET only)	✗
19	UL: 830 to 845	DL: 875 to 890	✗
20	UL: 832 to 862	DL: 791 to 821	✗
21	UL: 1447.9 to 1462.9	DL: 1495.9 to 1510.9	✗
22	UL: 3410 to 3490	DL: 3510 to 3590	✗
23	UL: 2000 to 2020	DL: 2180 to 2200 (LTE only)	✓
24	UL: 1625.5 to 1660.5	DL: 1525 to 1559 (LTE only)	✗
25	UL: 1850 to 1915	DL: 1930 to 1995	✓
26	UL: 814 to 849	DL: 859 to 894	✗
27	UL: 807 to 824	DL: 852 to 869 (LTE only)	✗
28	UL: 703 to 748	DL: 758 to 803 (LTE only)	✗
29	UL: -	DL: 717 to 728 (LTE only)	✓
30	UL: 2305 to 2315	DL: 2350 to 2360 (LTE only)	✓
31	UL: 452.5 to 457.5	DL: 462.5 to 467.5 (LTE only)	✗
32	UL: -	DL: 1452 - 1496	✗
35		1850 to 1910	✓
38		2570 to 2620	✓
39		1880 to 1920	✓
40		2300 to 2400	✓
41		2496 to 2690	✓
42		3400 to 3600	✗
43		3600 to 3800	✗

\*Covered bands represent an efficiency greater than 20%

## 2.4. LTE Bands – Bent on Edge of 300\*300mm Ground plane

LTE BANDS			
Band Number	LTE / LTE-Advanced / WCDMA / HSPA / HSPA+ / TD-SCDMA		
	Uplink	Downlink	Covered
1	UL: 1920 to 1980	DL: 2110 to 2170	✓
2	UL: 1850 to 1910	DL: 1930 to 1990	✓
3	UL: 1710 to 1785	DL: 1805 to 1880	✓
4	UL: 1710 to 1755	DL: 2110 to 2155	✓
5	UL: 824 to 849	DL: 869 to 894	✓
7	UL: 2500 to 2570	DL: 2620 to 2690	✓
8	UL: 880 to 915	DL: 925 to 960	✓
9	UL: 1749.9 to 1784.9	DL: 1844.9 to 1879.9	✓
11	UL: 1427.9 to 1447.9	DL: 1475.9 to 1495.9	✗
12	UL: 699 to 716	DL: 729 to 746	✓
13	UL: 777 to 787	DL: 746 to 756	✓
14	UL: 788 to 798	DL: 758 to 768	✓
17	UL: 704 to 716	DL: 734 to 746 (LTE only)	✓
18	UL: 815 to 830	DL: 860 to 875 (LTE only)	✓
19	UL: 830 to 845	DL: 875 to 890	✓
20	UL: 832 to 862	DL: 791 to 821	✓
21	UL: 1447.9 to 1462.9	DL: 1495.9 to 1510.9	✗
22	UL: 3410 to 3490	DL: 3510 to 3590	✗
23	UL: 2000 to 2020	DL: 2180 to 2200 (LTE only)	✓
24	UL: 1625.5 to 1660.5	DL: 1525 to 1559 (LTE only)	✓
25	UL: 1850 to 1915	DL: 1930 to 1995	✓
26	UL: 814 to 849	DL: 859 to 894	✓
27	UL: 807 to 824	DL: 852 to 869 (LTE only)	✓
28	UL: 703 to 748	DL: 758 to 803 (LTE only)	✓
29	UL: -	DL: 717 to 728 (LTE only)	✓
30	UL: 2305 to 2315	DL: 2350 to 2360 (LTE only)	✓
31	UL: 452.5 to 457.5	DL: 462.5 to 467.5 (LTE only)	✗
32	UL: -	DL: 1452 - 1496	✗
35		1850 to 1910	✓
38		2570 to 2620	✓
39		1880 to 1920	✓
40		2300 to 2400	✓
41		2496 to 2690	✓
42		3400 to 3600	✗
43		3600 to 3800	✗

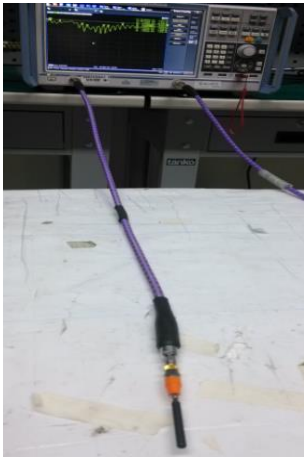
\*Covered bands represent an efficiency greater than 20%



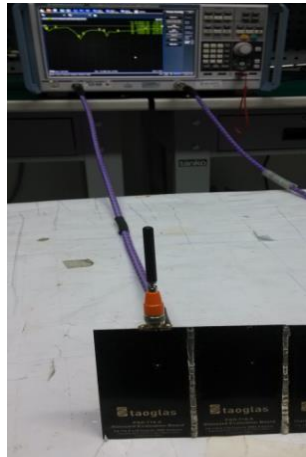
### 3. Antenna Characteristics

#### 3.1. Testing setup

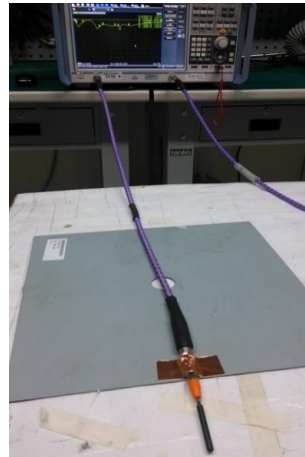
##### Antenna Straight Position



a) In free space

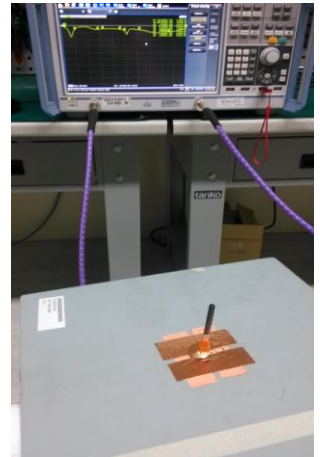


b) With 15\*9cm Ground



c) With 30\*30cm Ground

Metal Edge



d) With 30\*30cm Ground

Metal Center

##### Antenna Bent Position



a) In free space

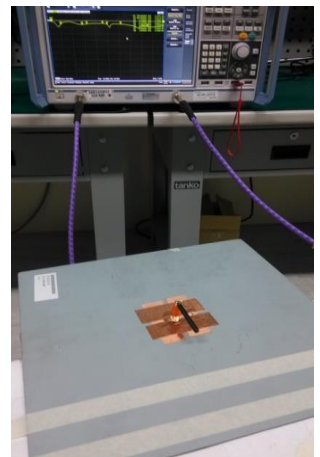


b) With 15\*9cm Ground



c) With 30\*30cm Ground

Metal Edge

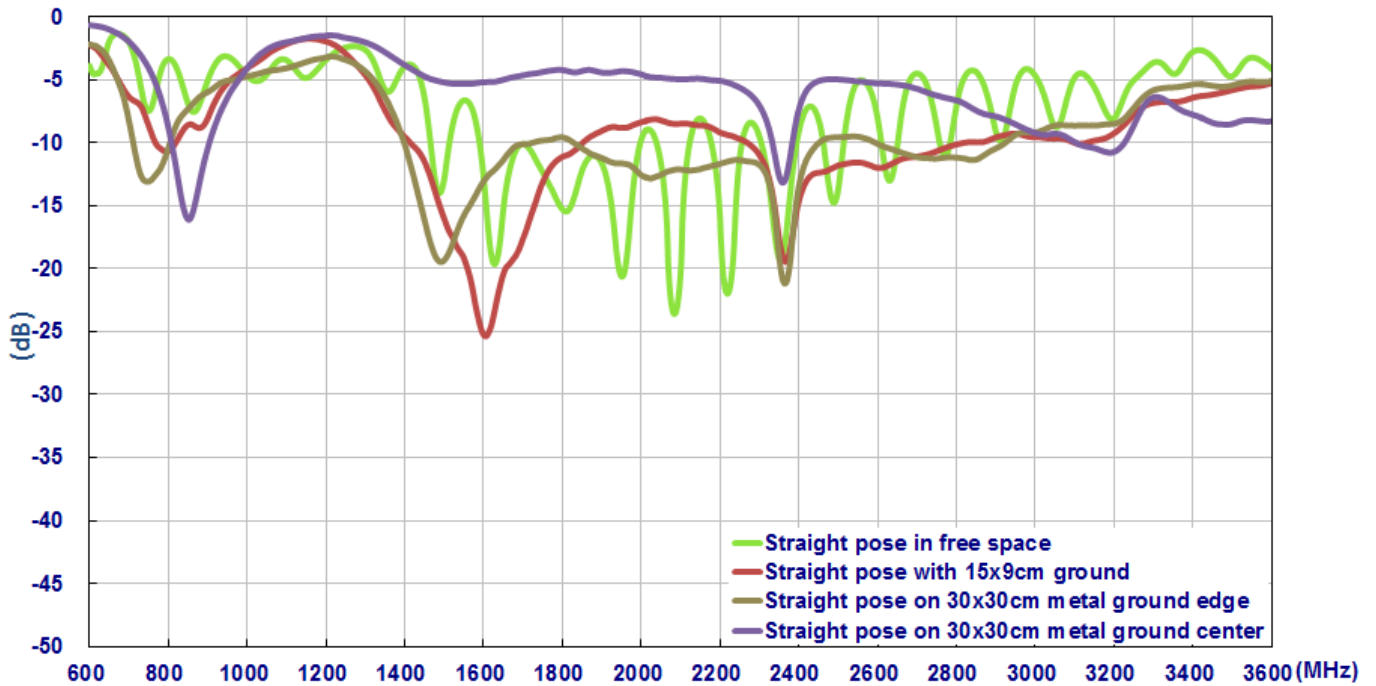


d) With 30\*30cm Ground

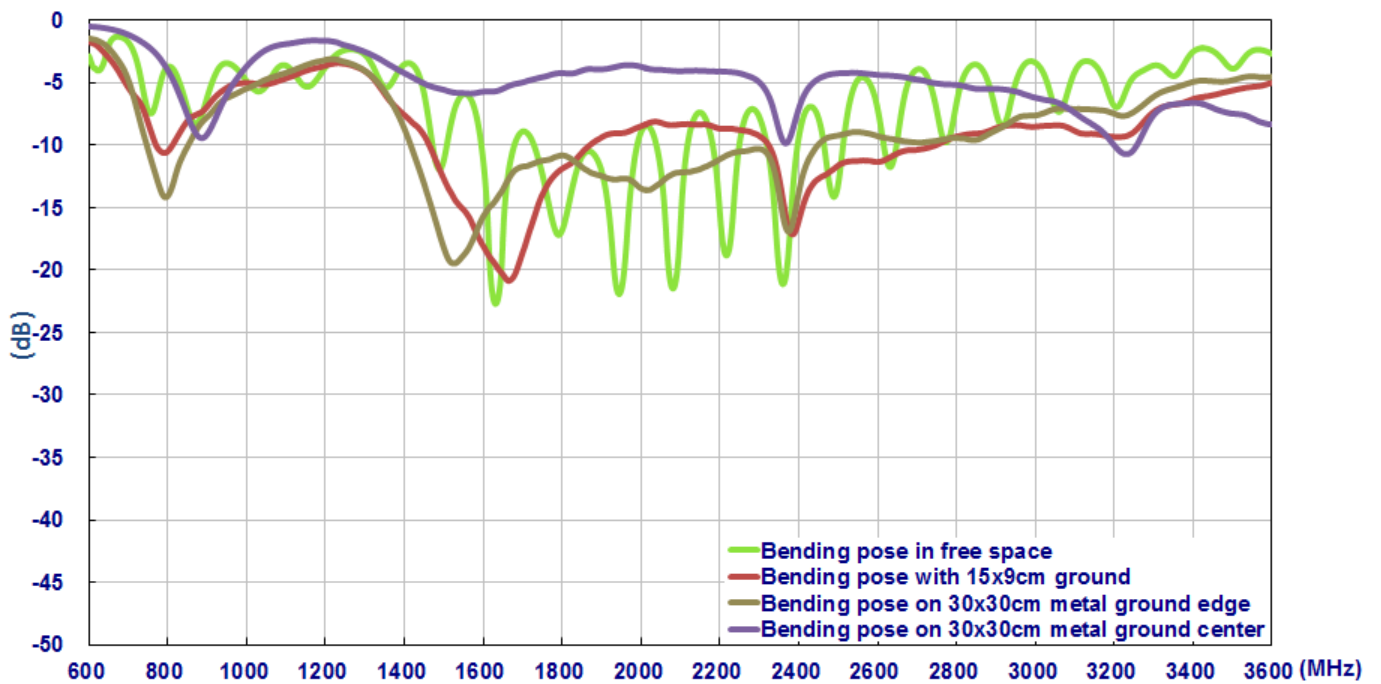
Metal Center

**Figure.1** Measurement environments

### 3.2. Return loss

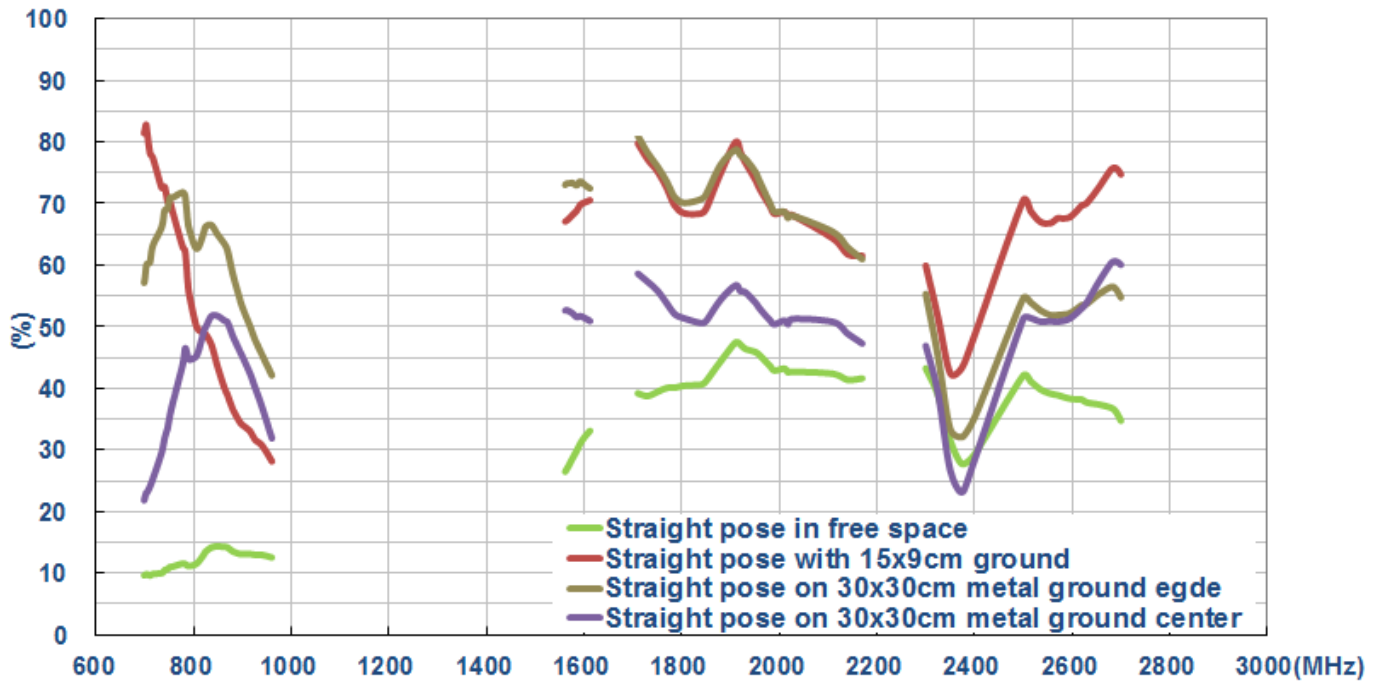


**Figure2.** Return loss of TG.08 antenna with straight Position

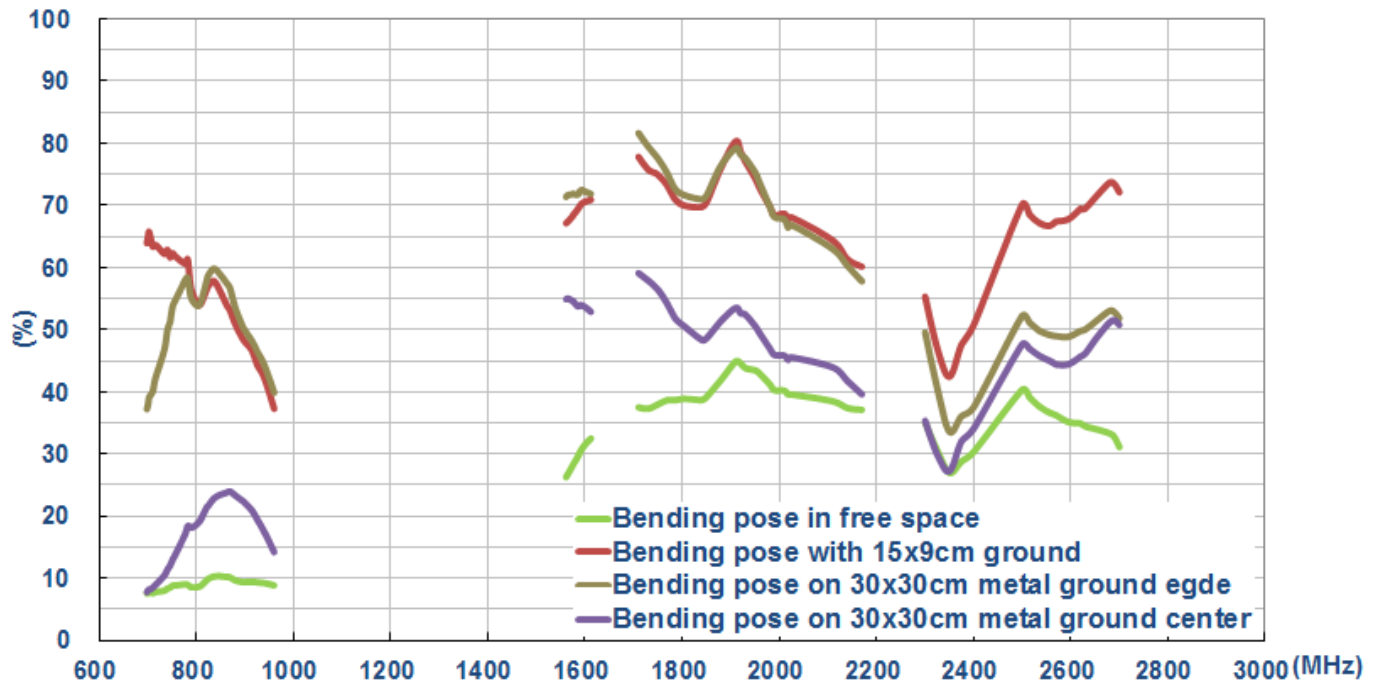


**Figure3.** Return loss of TG.08 antenna with bent Position

### 3.3. Efficiency



**Figure4.** Efficiency of TG.08 antenna with straight Position

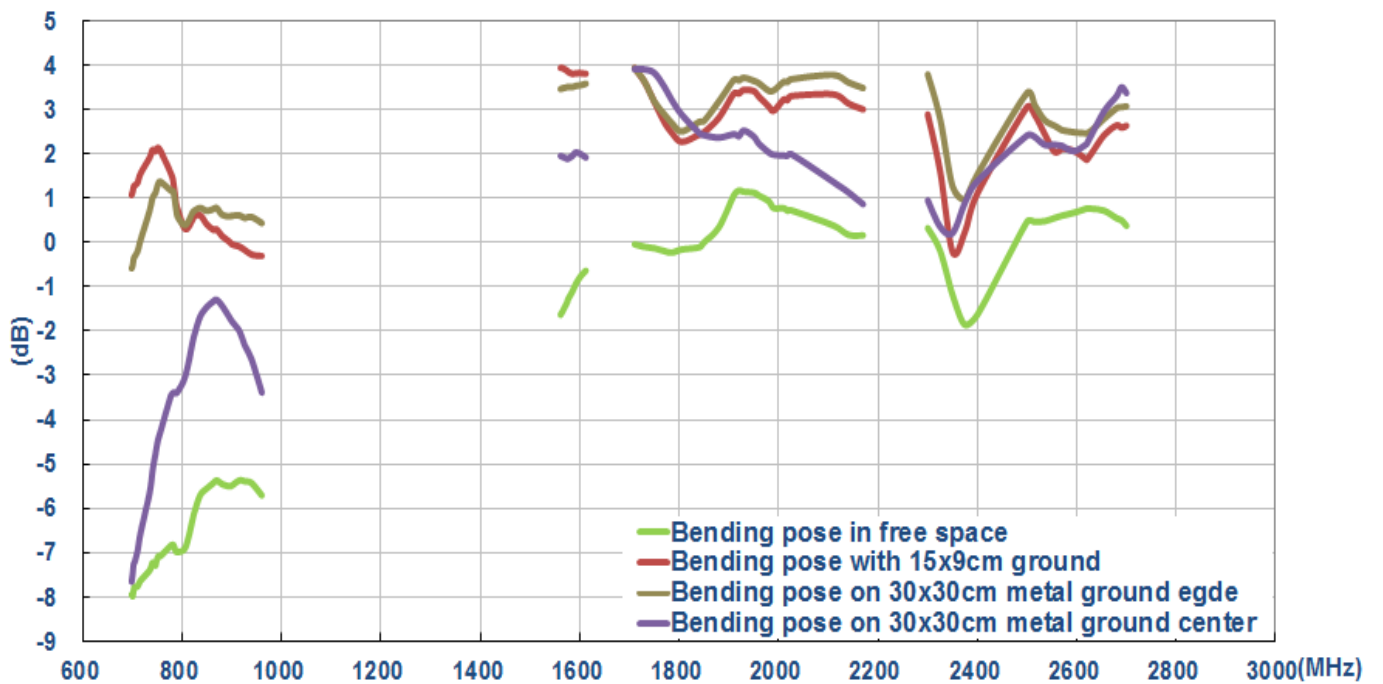


**Figure5.** Efficiency of TG.08 antenna with bent Position

### 3.4. Peak gain

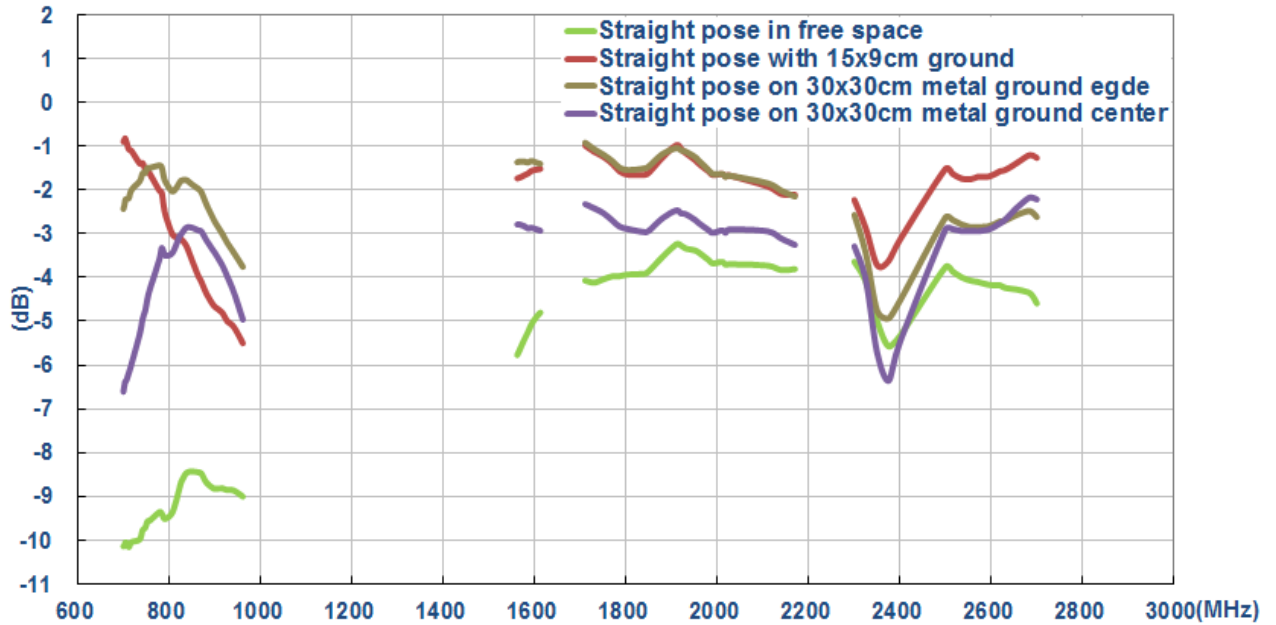


**Figure6.** Peak gain of TG.08 antenna with straight Position

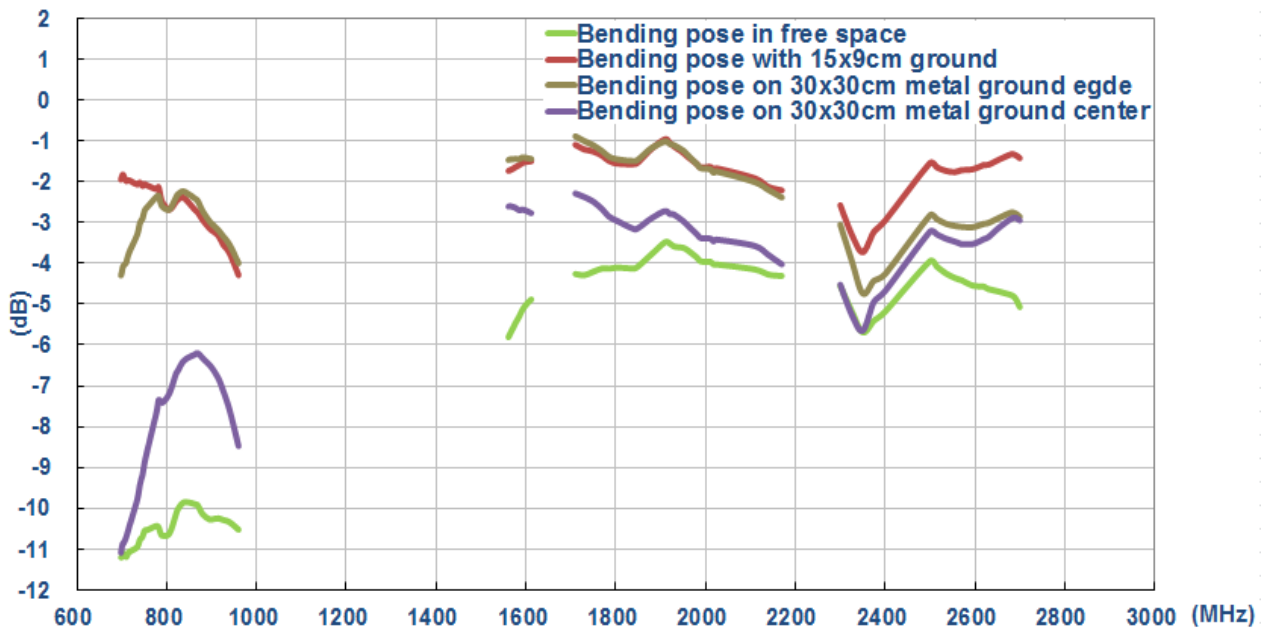


**Figure7.** Peak gain of TG.08 antenna with bent Position

### 3.5. Average gain



**Figure8.** Average gain of TG.08 with antenna straight Position

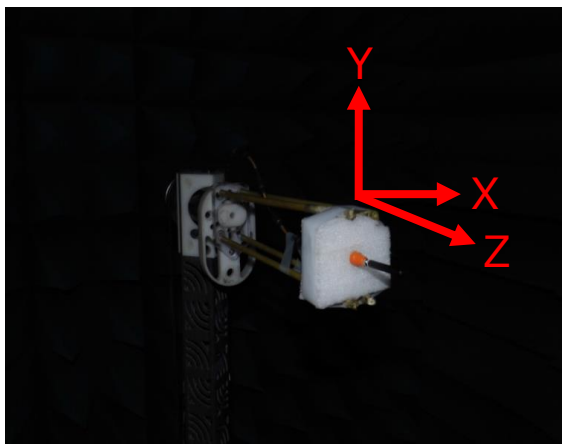


**Figure9.** Average gain of TG.08 antenna with bent Position

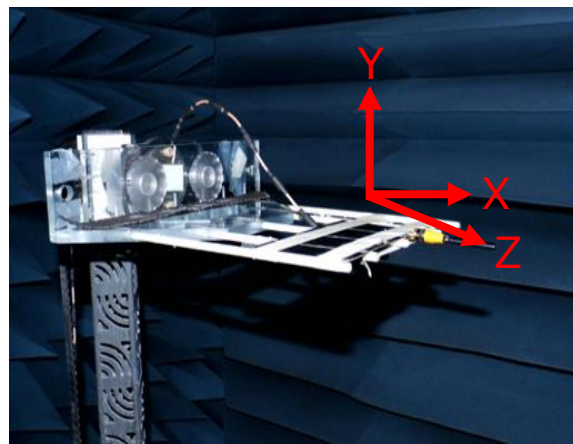
## 4. Antenna Radiation Patterns

The antenna radiation patterns were measured in a CTIA certified ETS Anechoic Chamber. The measurement setups are shown below.

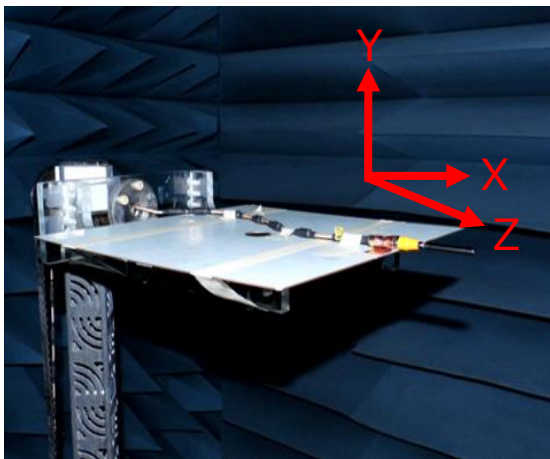
### Antenna with Straight Position



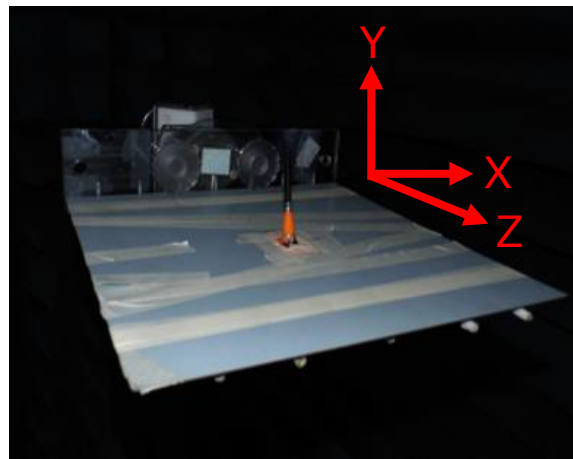
In free space



On 15x9cm ground plane

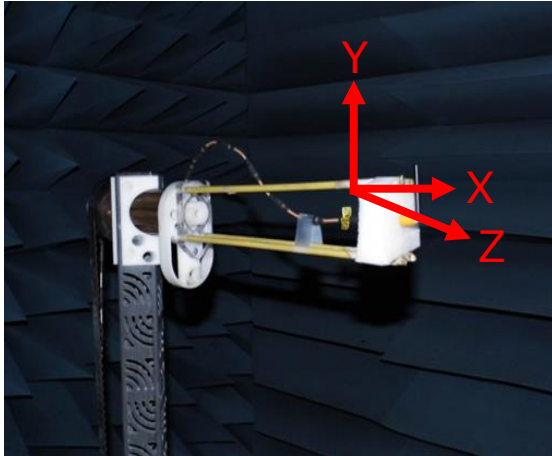


On 30x30cm metal ground center

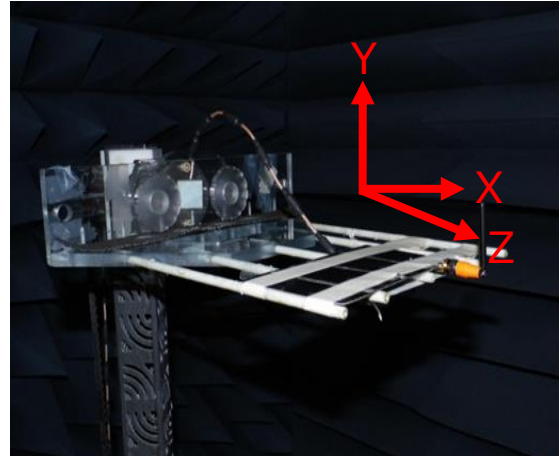


On 30x30cm metal ground edge

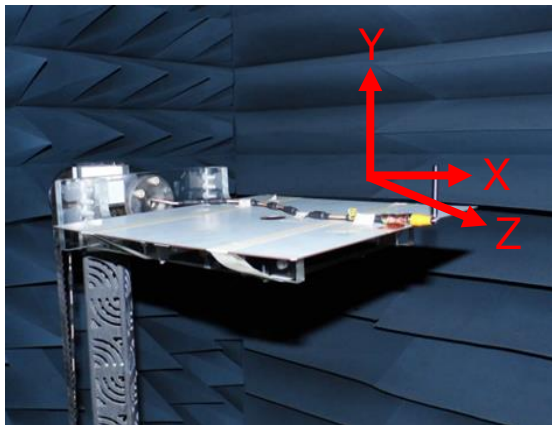
### Antenna with Bent Position



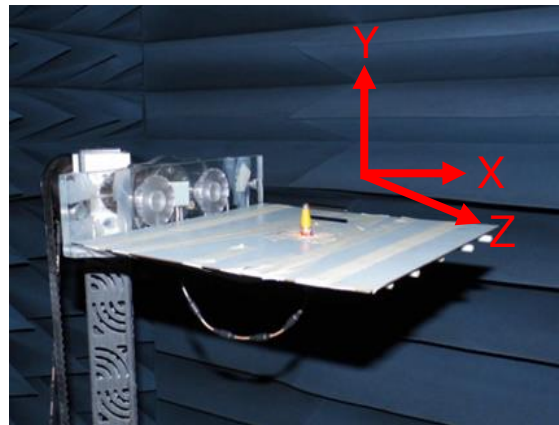
In free space



On 15x9cm ground plane



On 30x30cm metal ground center



On 30x30cm metal ground edge

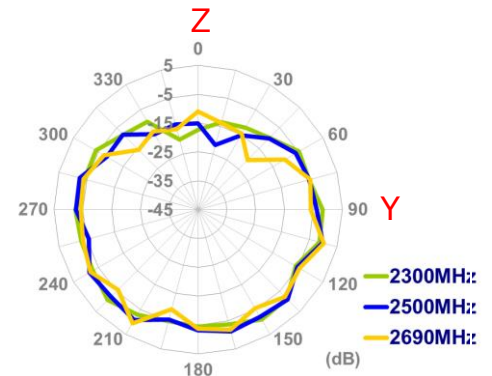
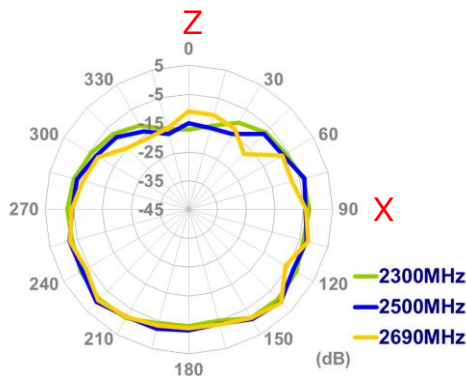
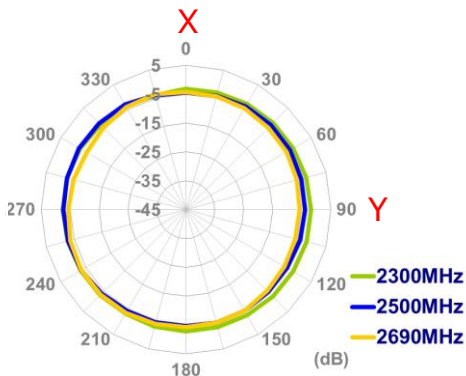
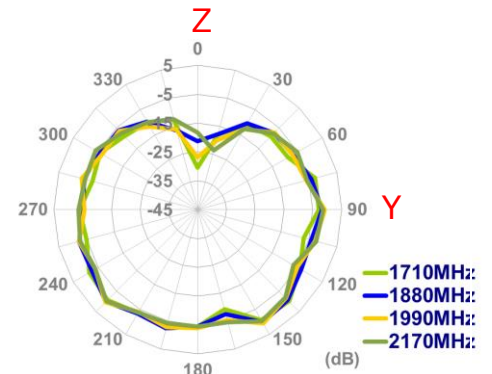
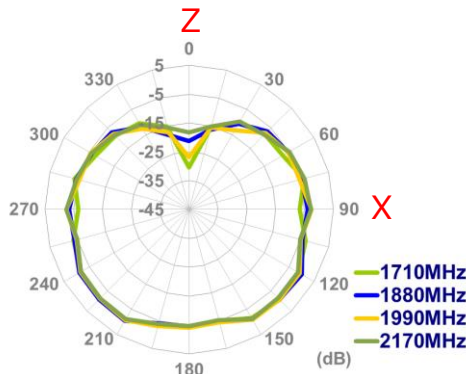
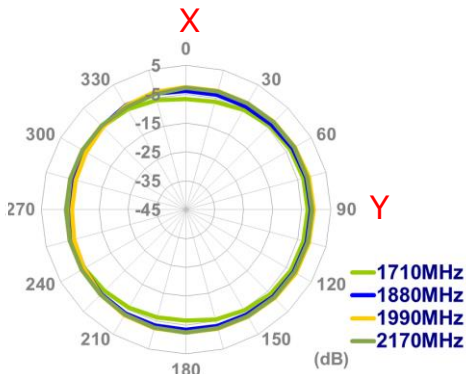
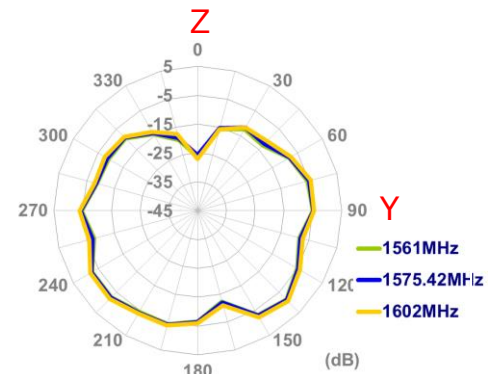
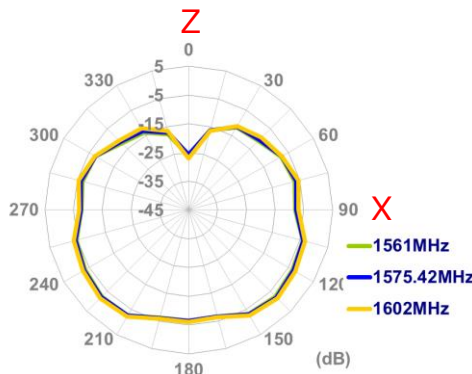
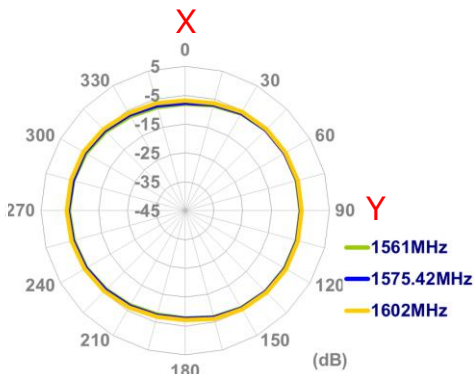
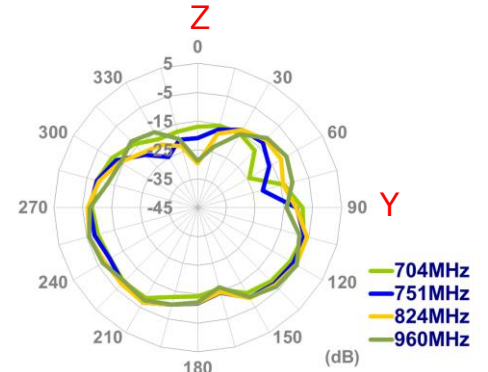
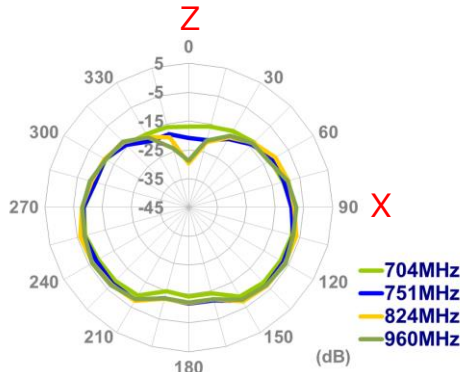
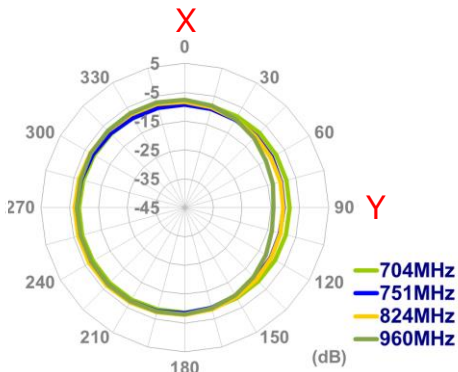
**Figure.10.** Testing Setup in ETS Anechoic Chamber

### 4.1. 2D Radiation pattern (Straight Position in free space)

XY Plane

XZ Plane

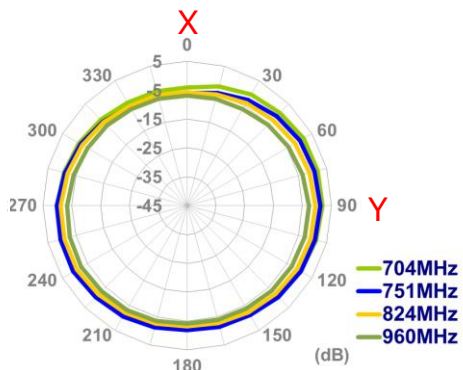
YZ Plane



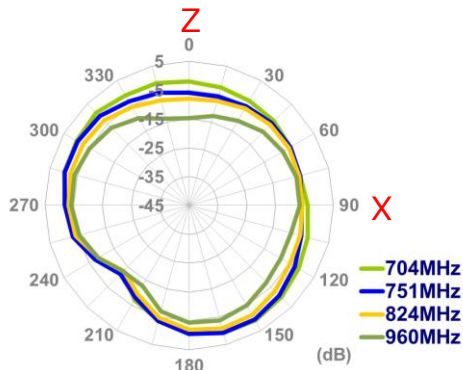


## 4.2. 2D Radiation pattern (Straight Position with 15x9cm ground)

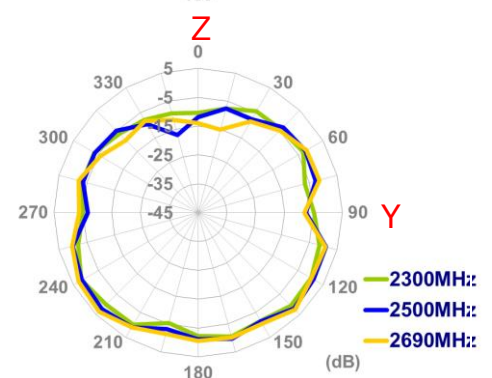
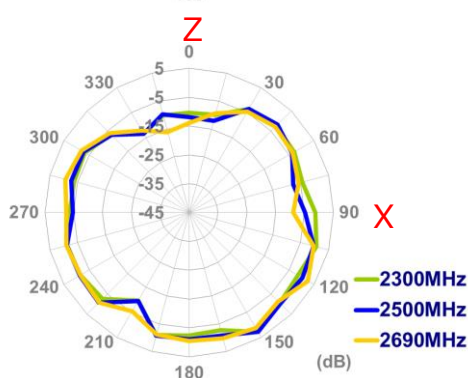
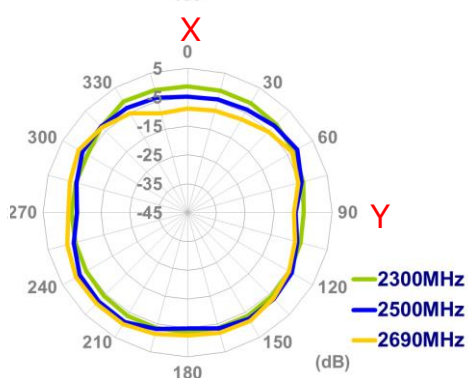
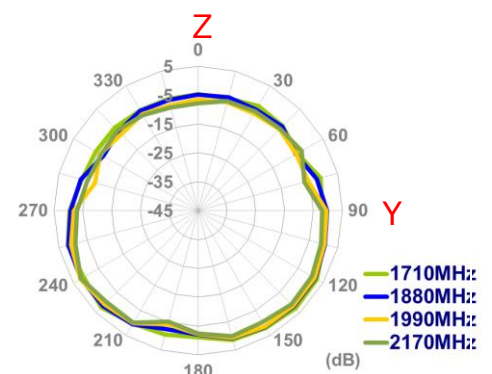
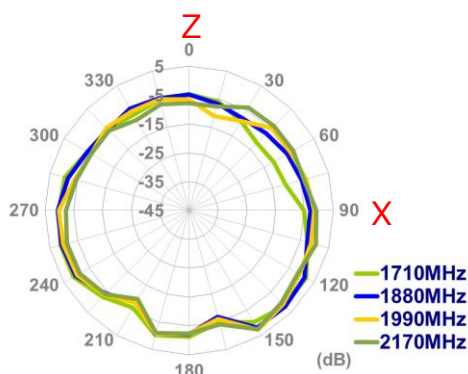
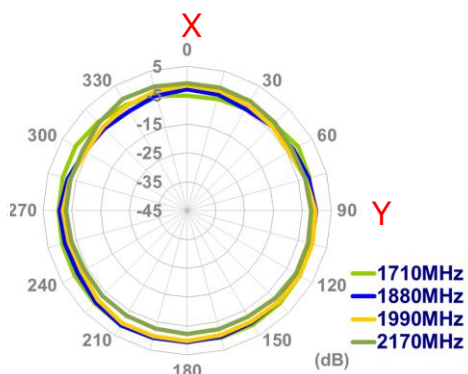
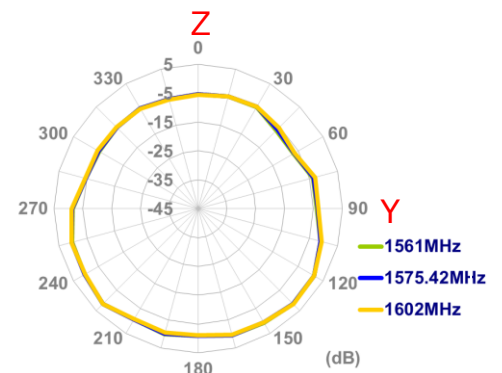
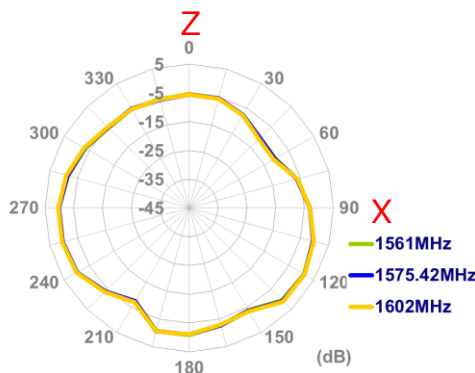
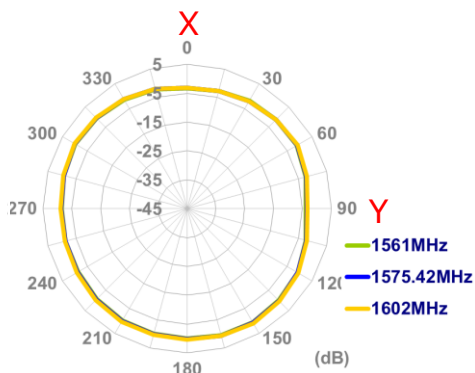
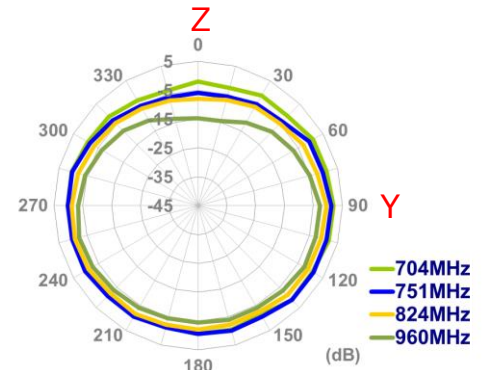
XY Plane



XZ Plane



YZ Plane

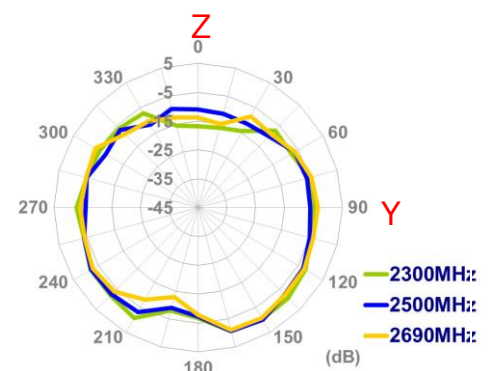
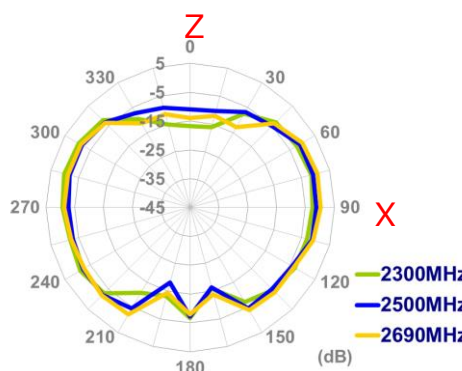
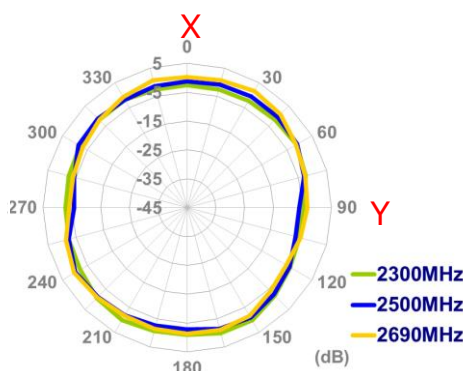
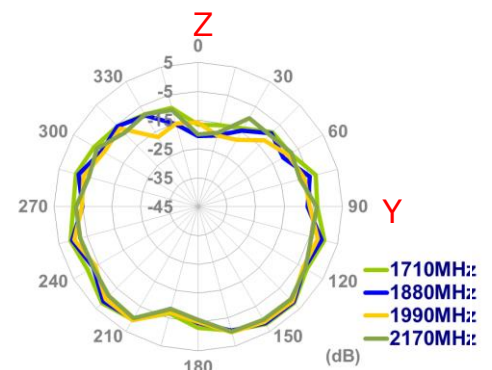
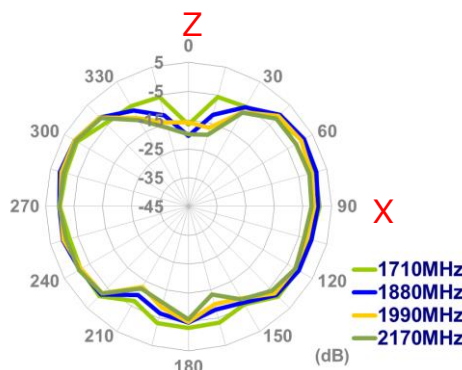
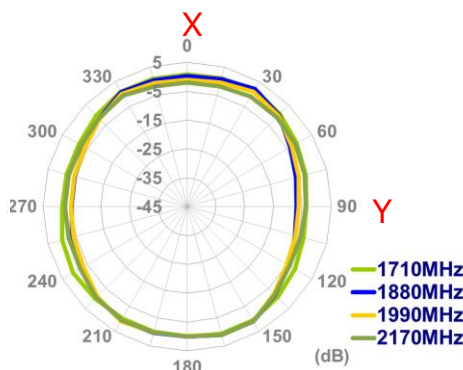
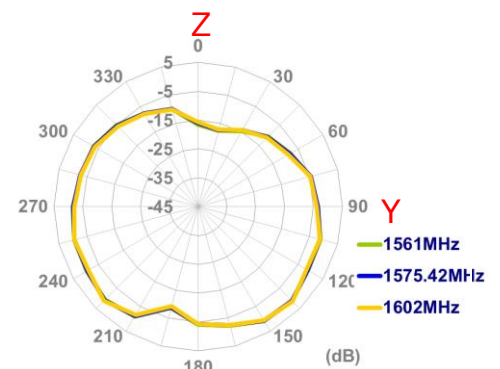
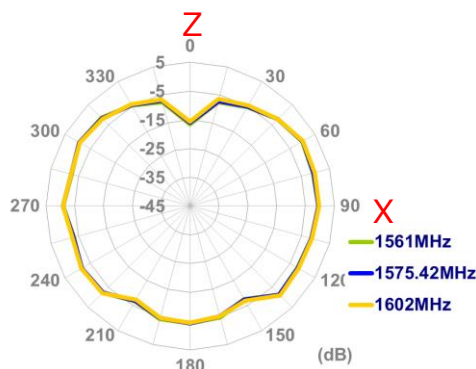
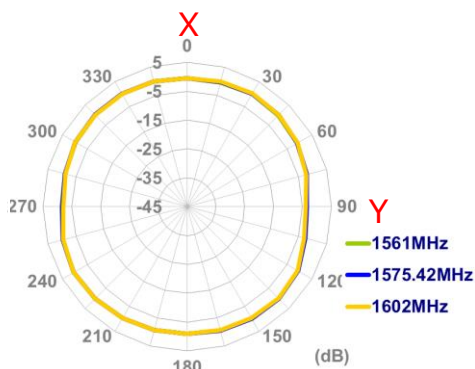
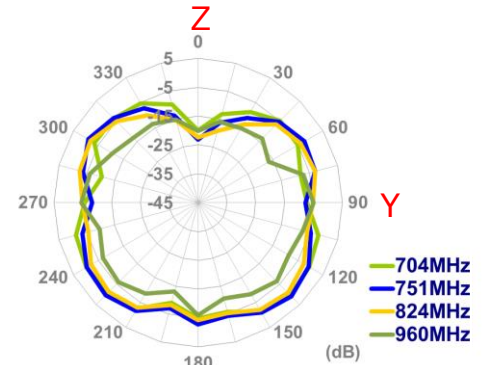
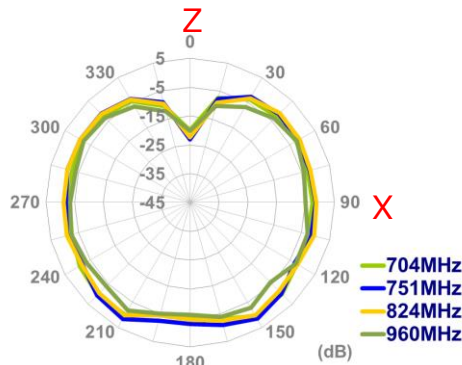
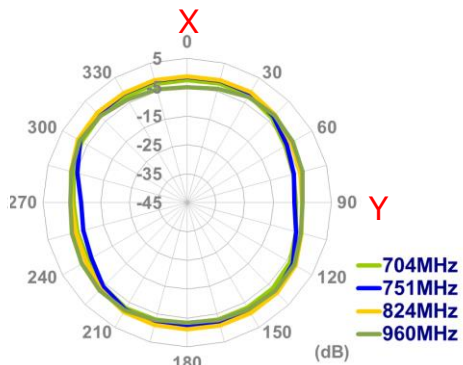


### 4.3. 2D Radiation pattern (Straight Position with 30x30cm Metal Ground Edge)

XY Plane

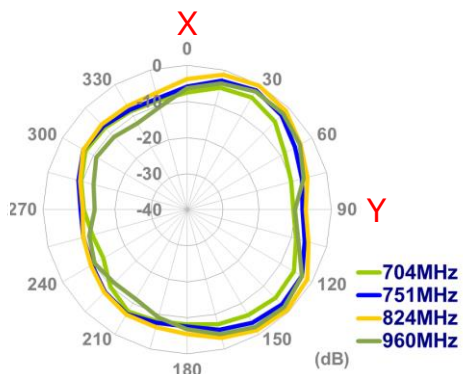
XZ Plane

YZ Plane

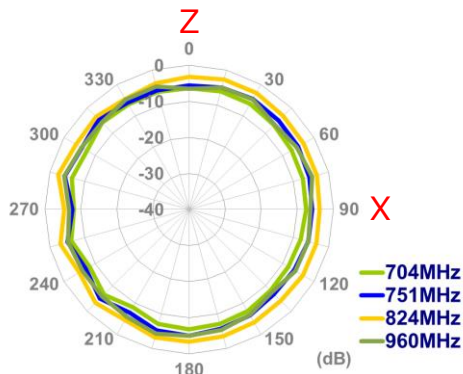


### 4.4. 2D Radiation pattern (Straight Position with 30x30cm metal ground center)

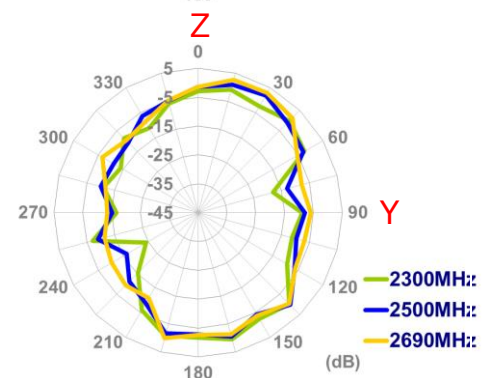
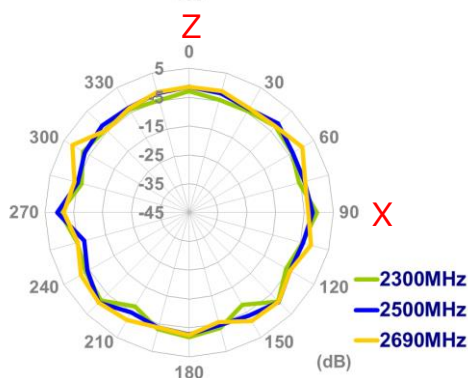
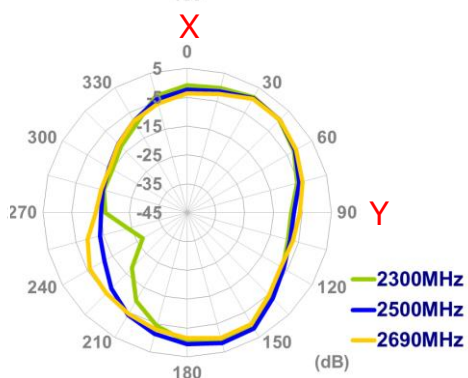
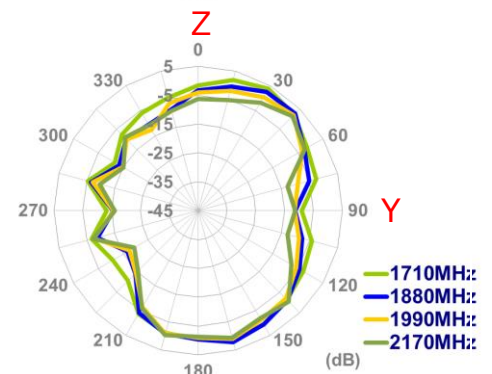
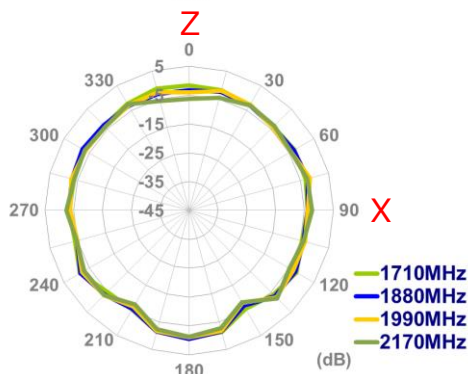
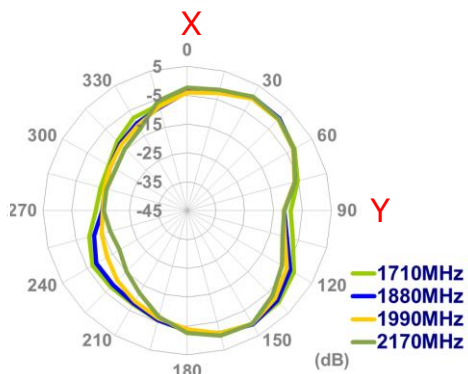
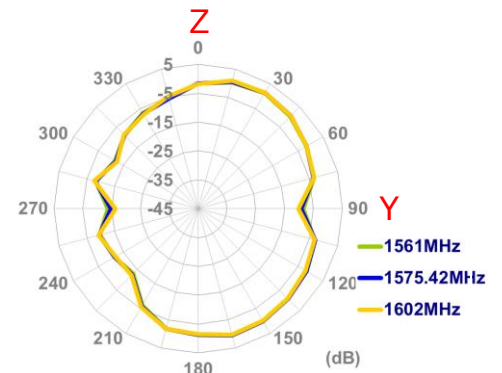
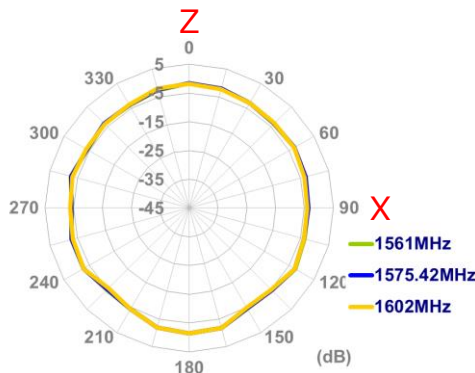
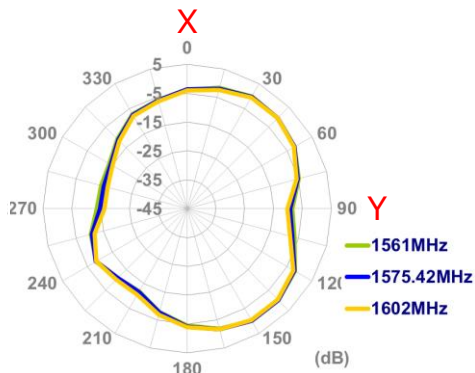
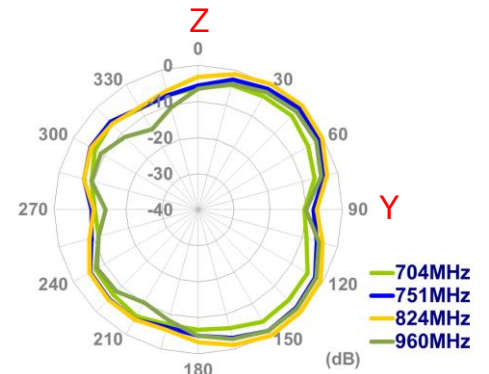
XY Plane



XZ Plane



YZ Plane

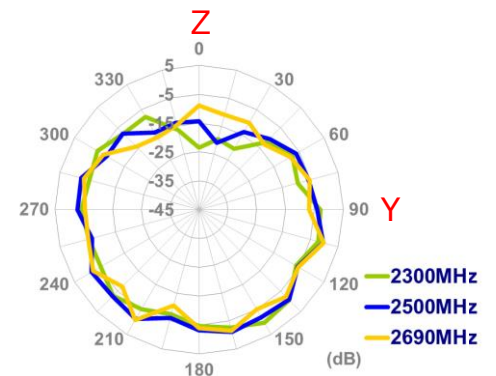
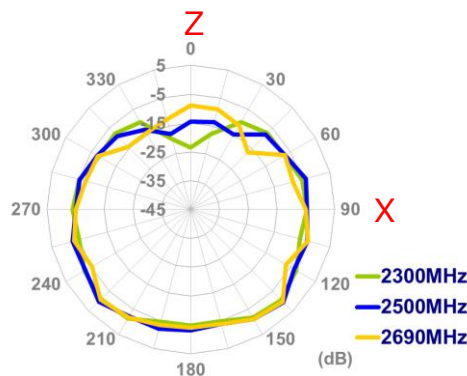
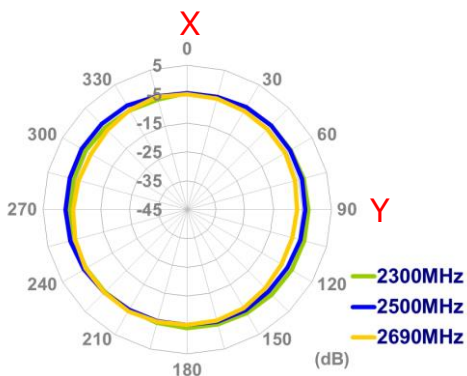
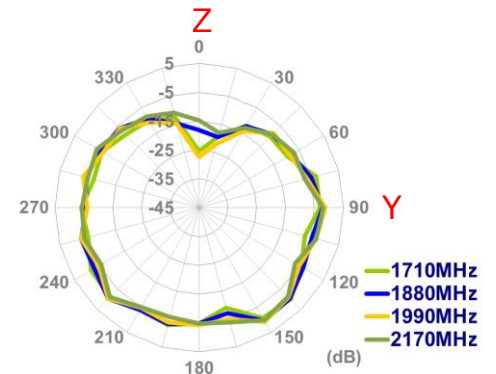
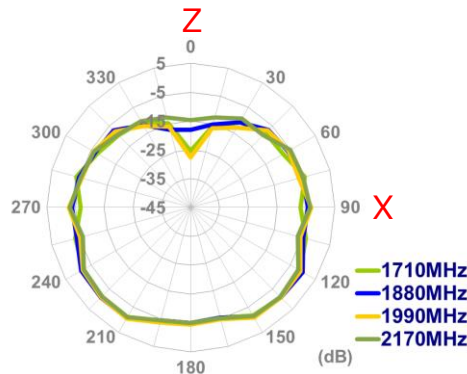
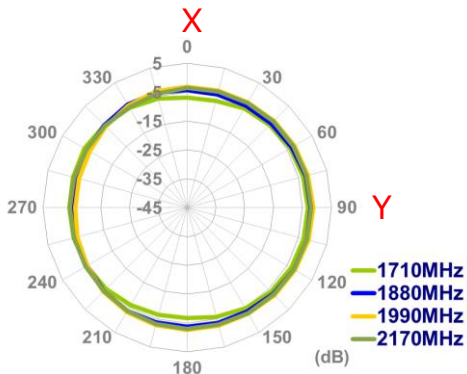
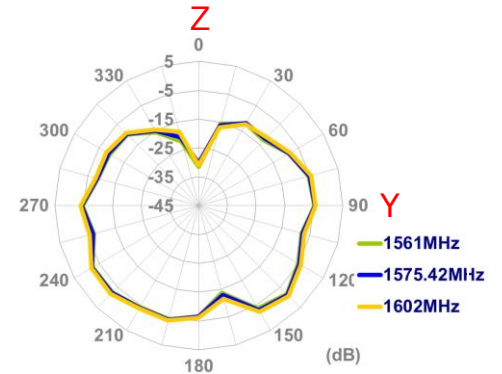
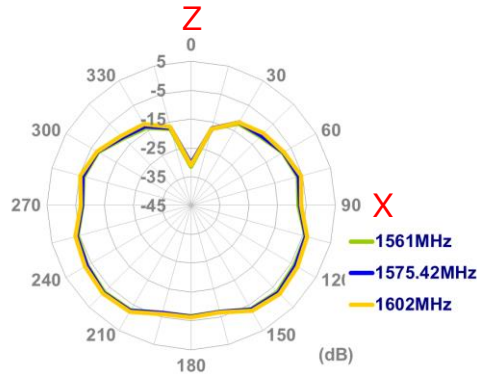
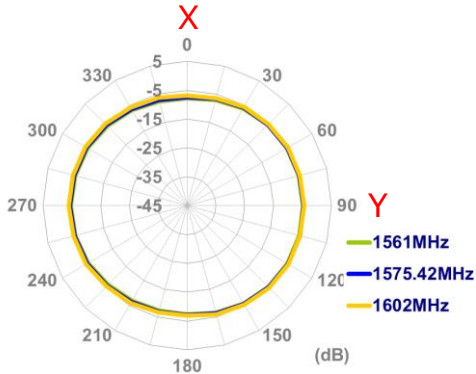
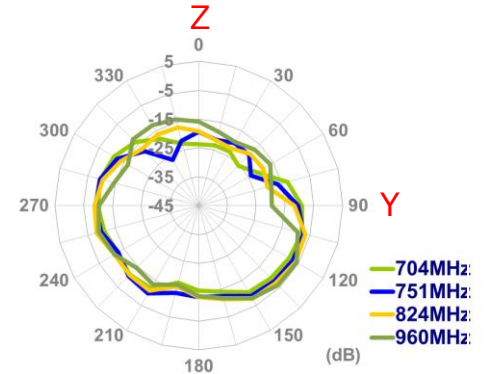
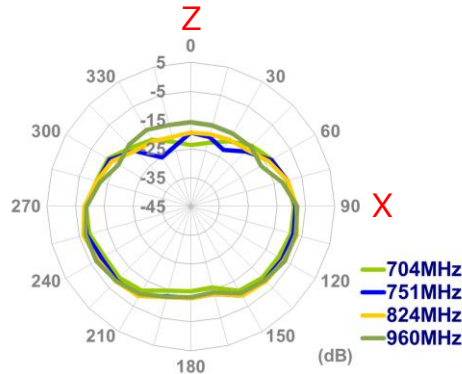
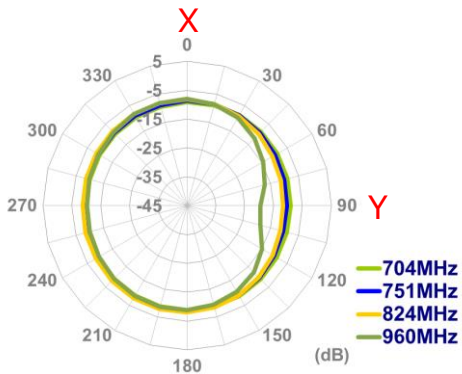


### 4.5. 2D Radiation pattern (Bent Position in free space)

XY Plane

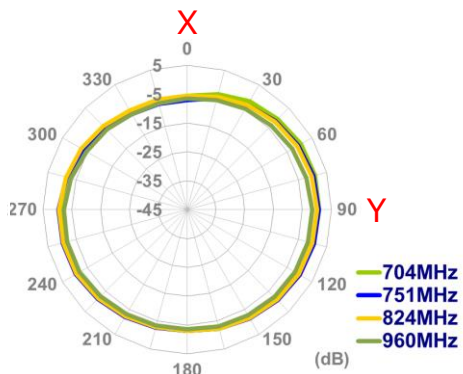
XZ Plane

YZ Plane

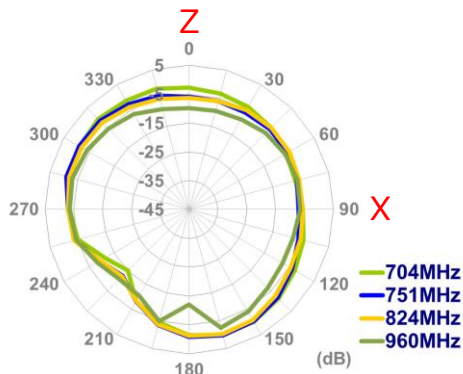


### 4.6. 2D Radiation pattern (Bent Position with 15x9cm ground)

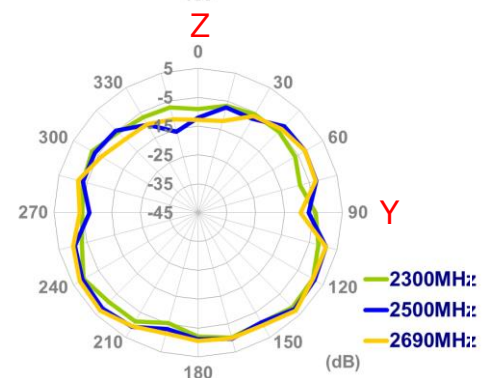
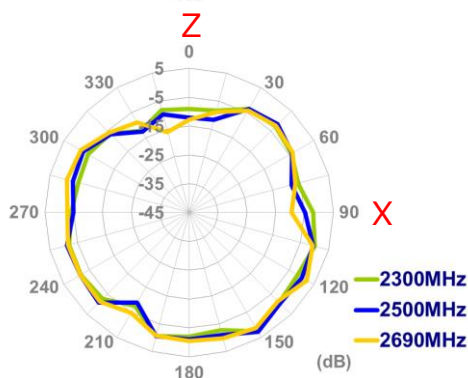
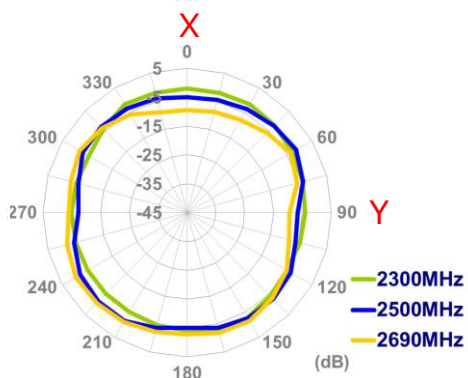
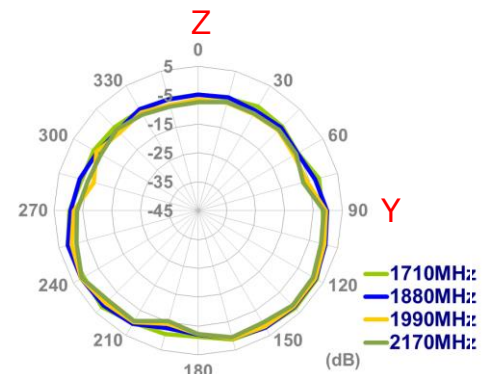
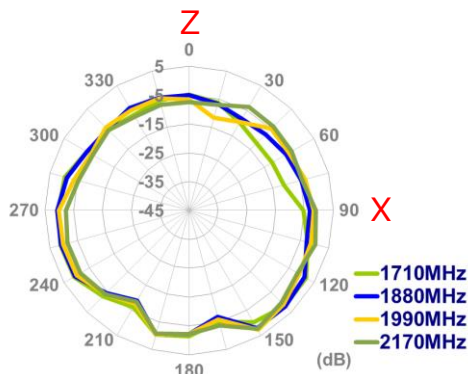
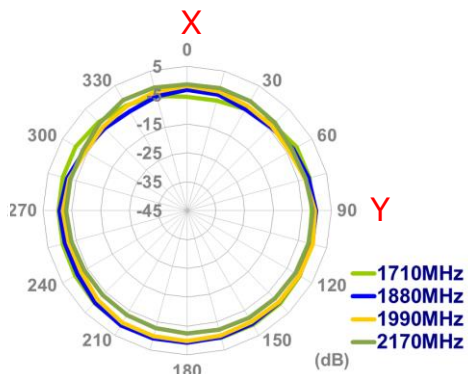
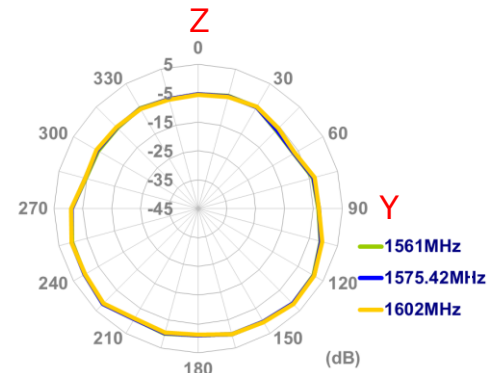
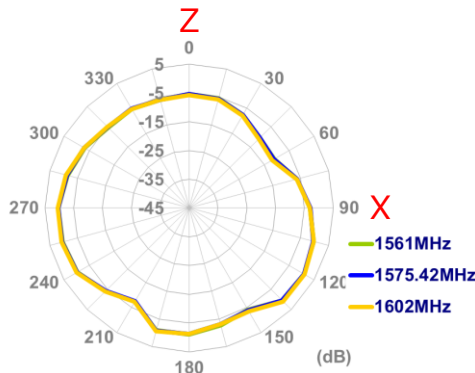
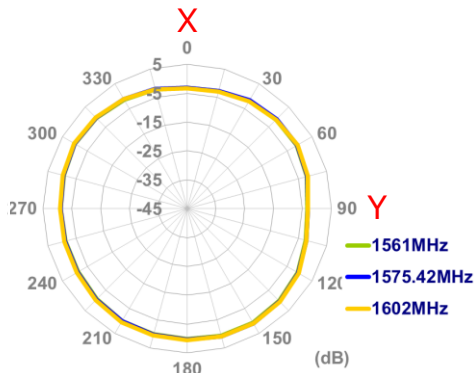
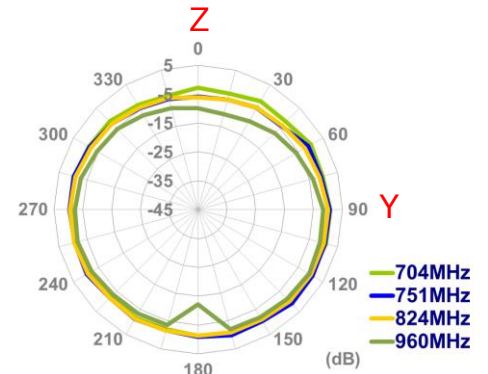
XY Plane



XZ Plane

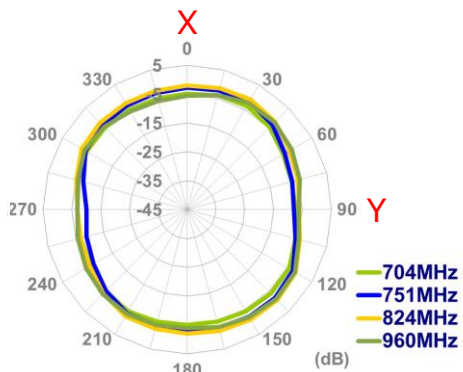


YZ Plane

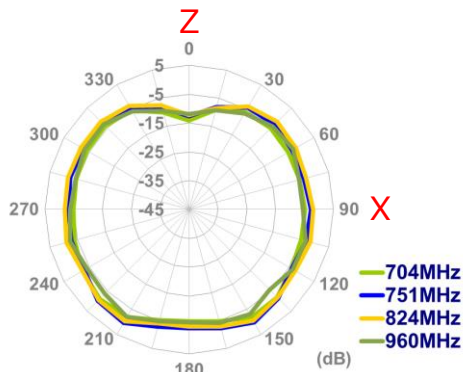


### 4.7. 2D Radiation pattern (Bent Position with 30x30cm metal ground edge)

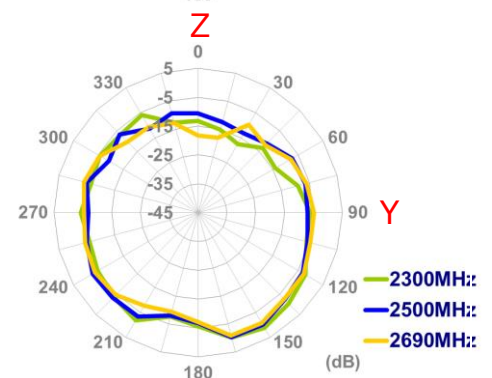
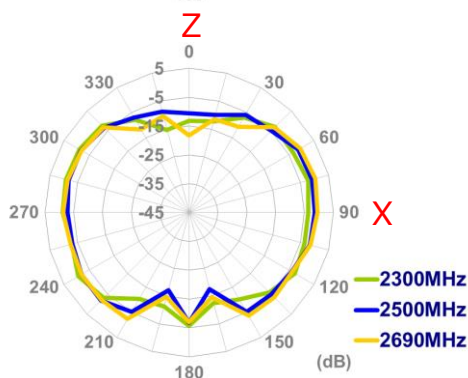
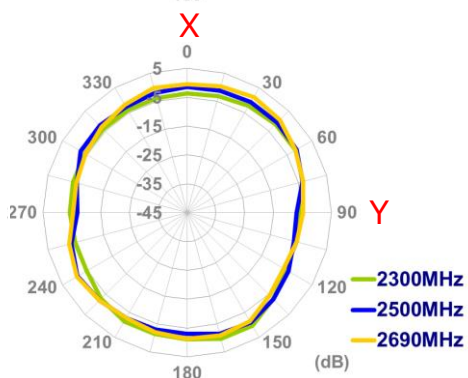
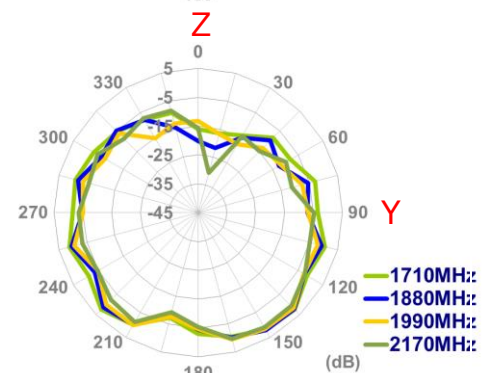
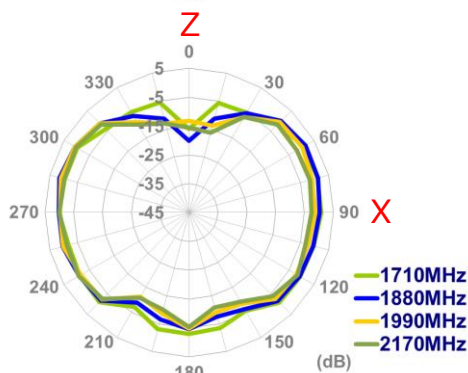
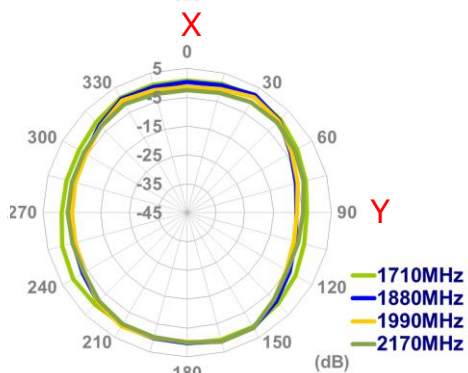
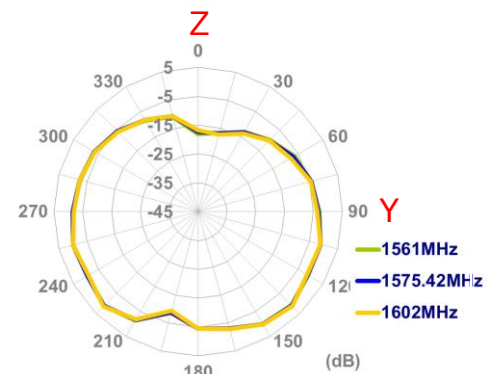
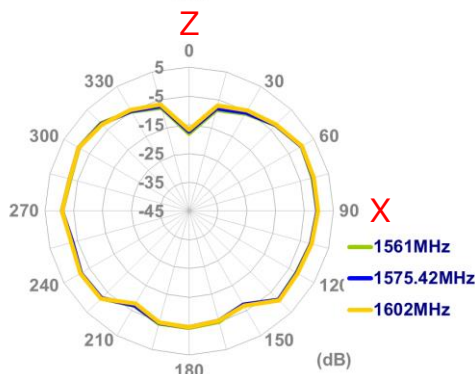
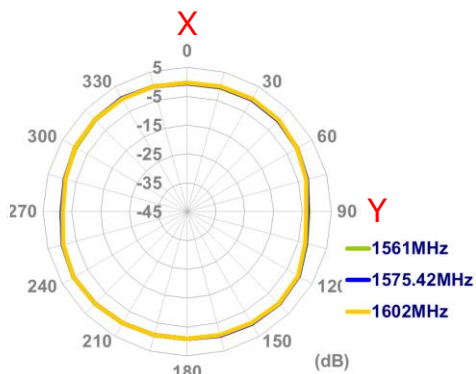
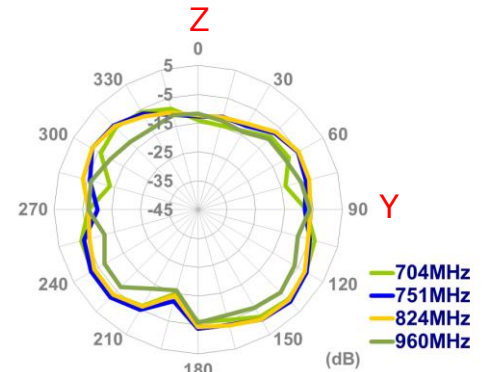
XY Plane



XZ Plane

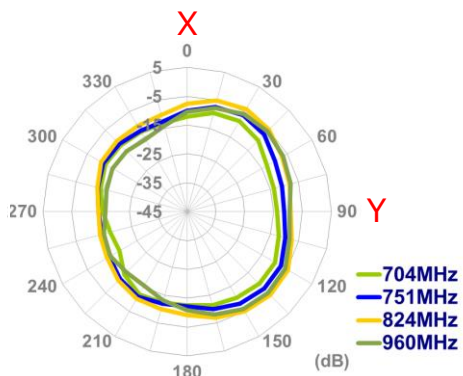


YZ Plane

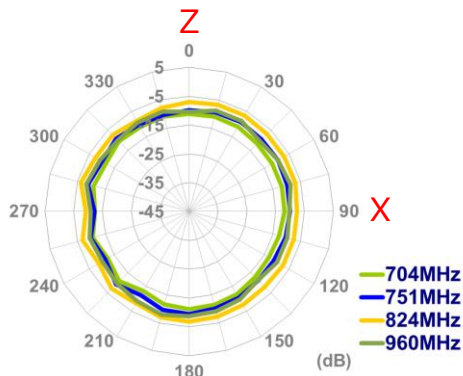


### 4.8. 4.8 2D Radiation pattern (Bent Position with 30\*30cm metal ground center)

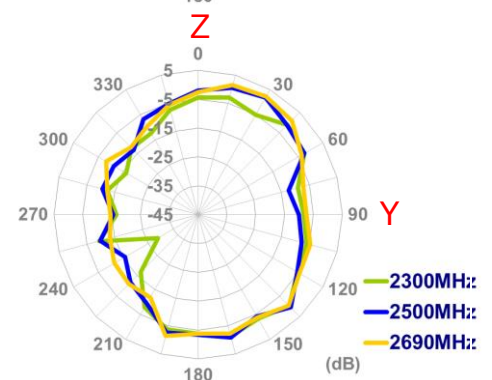
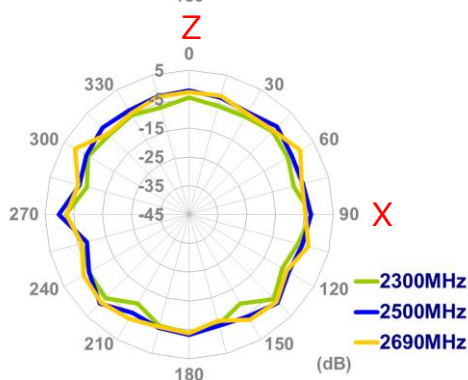
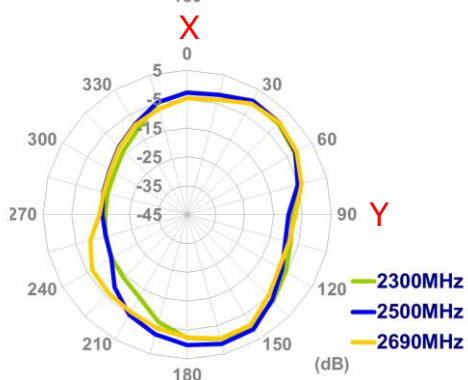
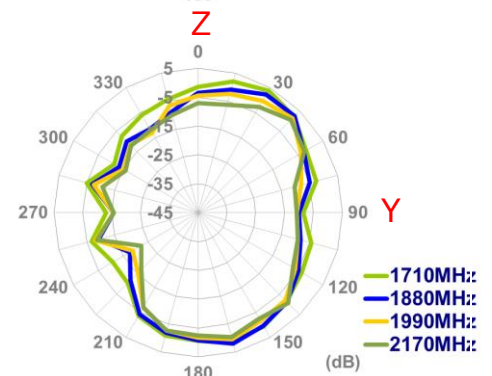
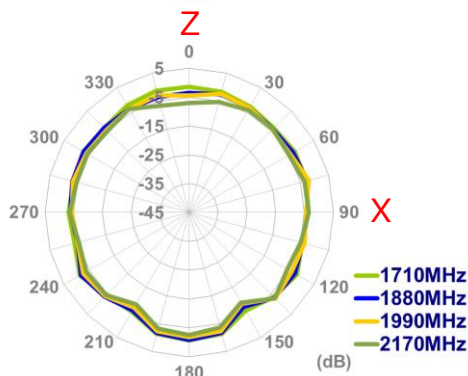
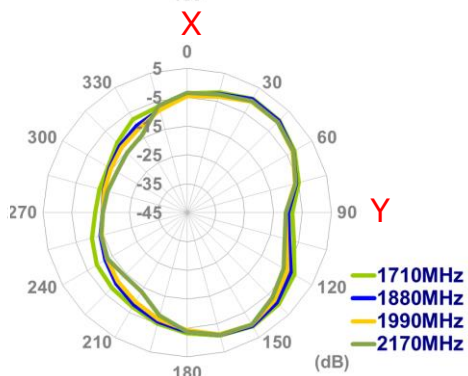
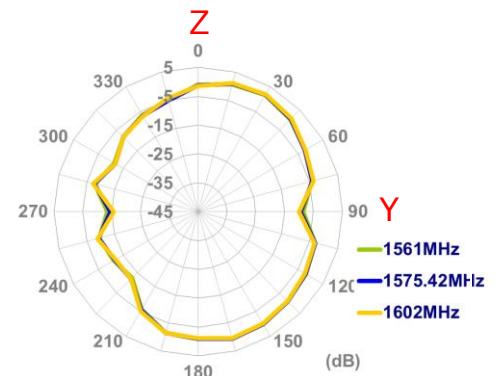
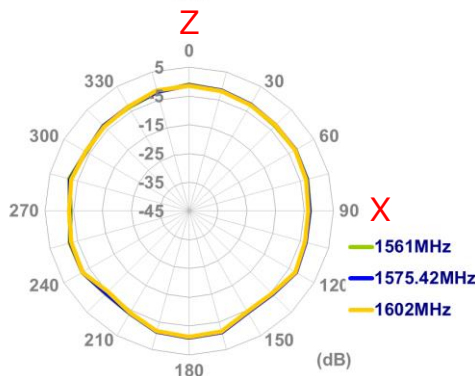
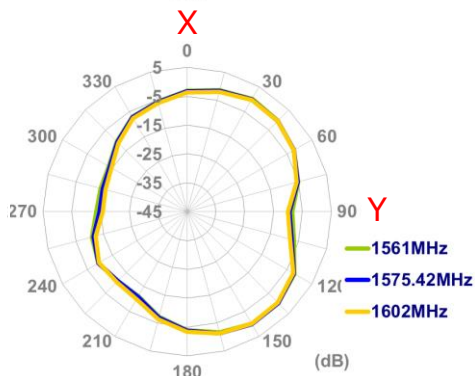
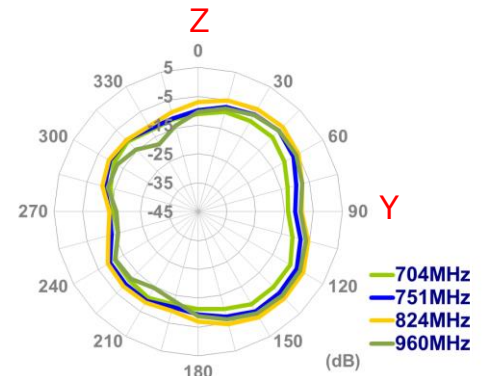
XY Plane



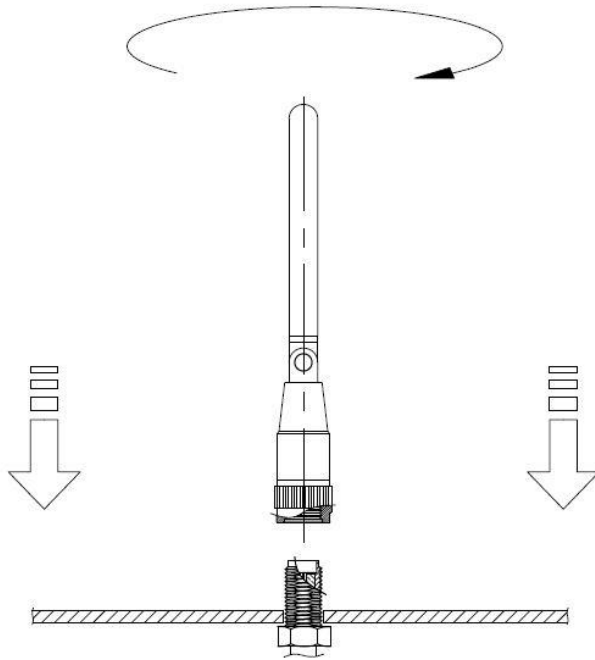
XZ Plane



YZ Plane



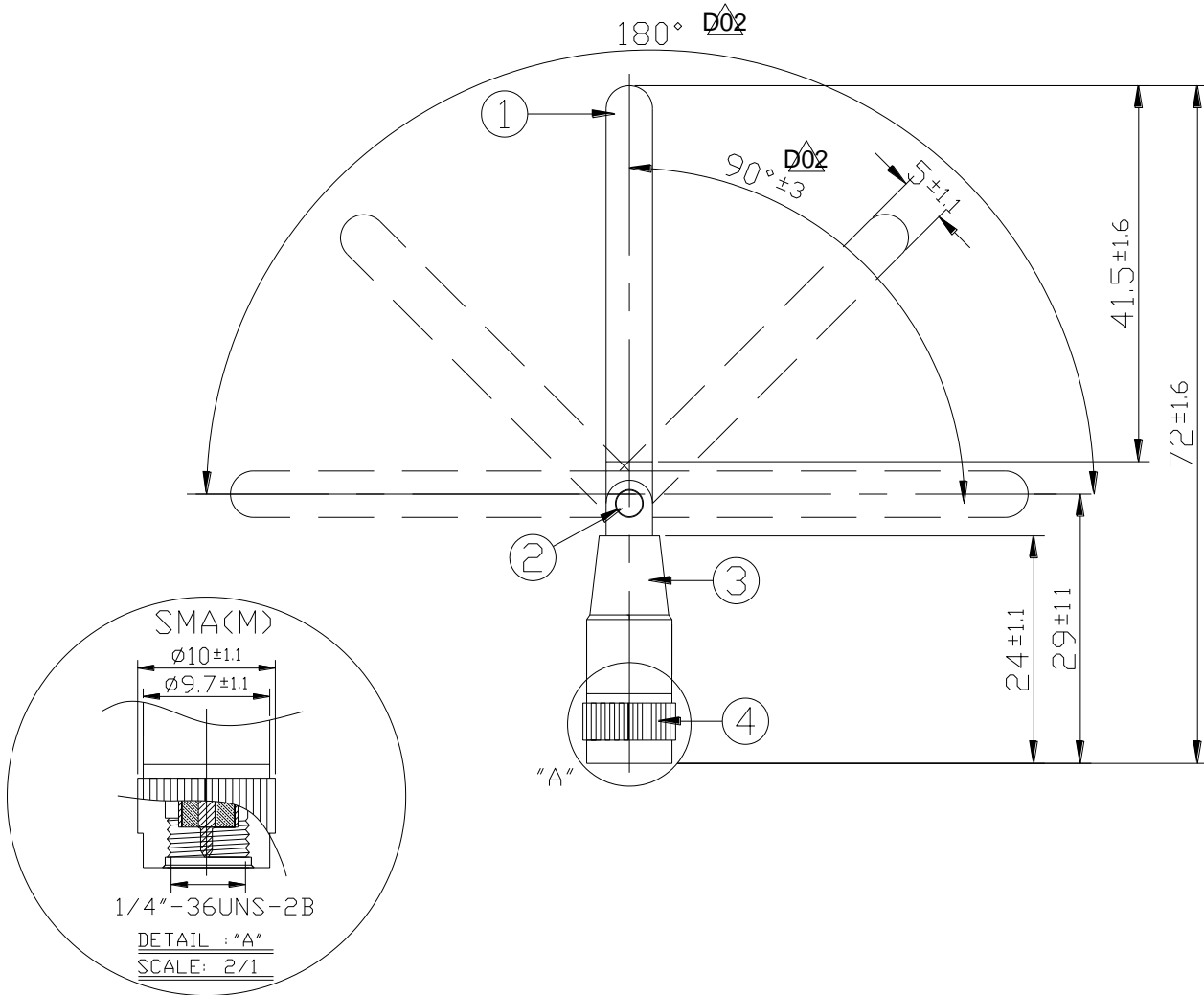
## 5. Installation



Recommended torque for mounting is 0.9 N.m  
Maximum torque for mounting is 1.176 N.m

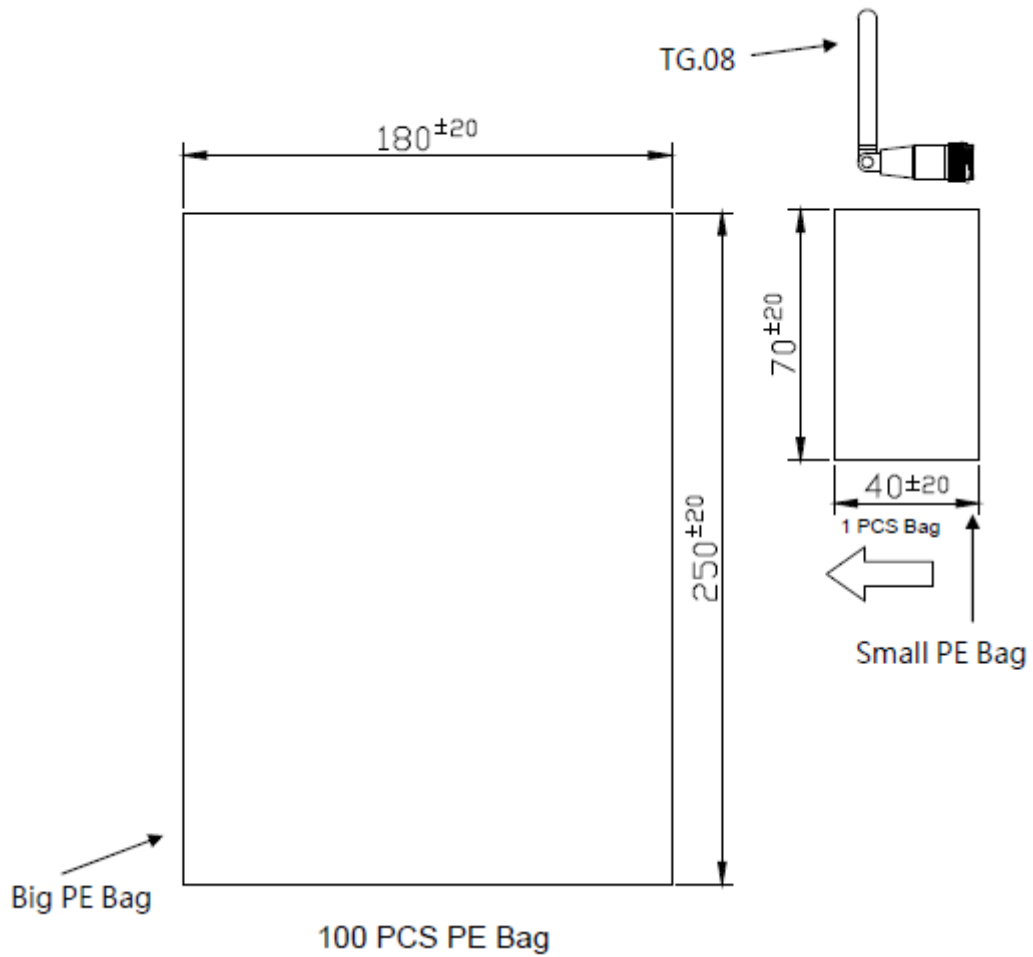


## 6. Drawing



	Name	P/N	Material	Finish	QTY
1	Housing	001013F000002A	POM	Black	1
2	Hinge	000613F000002A	Brass	Ni Plated	1
3	Cap	000713G000002A	POM	Orange $\overset{\Delta}{D03}$	1
4	SMA(M) ST	200213F000002A	Brass	Ni Plated	1

## 7. Packaging



Taoglas makes no warranties based on the accuracy or completeness of the contents of this document and reserves the right to make changes to specifications and product descriptions at any time without notice. Taoglas reserves all rights to this document and the information contained herein.

Reproduction, use or disclosure to third parties without express permission is strictly prohibited.

Copyright © Taoglas Ltd.