



# TAOGLAS®



# Datasheet

## WarriorX

**Part No:**  
PA.760.A

### Description:

WarriorX Wideband (600-6000MHz) Antenna for 5G NR & 4G Bands

### Features:

Patent Pending Innovative Design

High Efficiency Wideband Antenna, Covering 600 to 6000 MHz

Supporting all 5G NR Bands

600MHz 5G/4G Band 71 Support

Surface Mount Distribution (SMD) - Supplied on Tape & Reel

Dimensions: 40 x 5 x 6 mm

Manufactured in an IATF16949 Certified Facility

RoHS & REACH Compliant

1. Introduction	3
2. Specifications	4
3. Antenna Characteristics	6
4. Radiation Patterns	8
5. Mechanical Drawing	20
6. Evaluation Board Matching Circuit	26
7. Packaging	27
8. Application Note	28
9. Solder Reflow Temperature	32
<hr/>	
Changelog	33

Taoglas makes no warranties based on the accuracy or completeness of the contents of this document and reserves the right to make changes to specifications and product descriptions at any time without notice. Taoglas reserves all rights to this document and the information contained herein. Reproduction, use or disclosure to third parties without express permission is strictly prohibited.



# 1. Introduction



The Taoglas, WarriorX PA.760.A is a patent pending 5G/4G, high-efficiency, wideband(600-6000MHz) SMD ceramic antenna, designed to cover newly established 5G NR bands for worldwide deployment and worldwide 4G bands. It uses high grade custom ceramic and innovative design techniques to deliver the highest efficiencies in a small footprint across all bands when mounted on the device's main PCB.

The PA.760 is backward compatible for global 3G/2G applications if required. The PA.760 is delivered on tape and reel and mounted securely during the device PCB reflow process. The PA.760 also operates with great efficiency on worldwide NB-IoT and CAT-M frequency bands.

Typical applications include:

- Transportation
- Robotics
- Wearables
- Autonomous/UAVs
- Industrial IoT

The PA.760 is more resistant to detuning compared to other antenna integrations. If tuning is required it can be tuned for the device environment using a matching circuit, or other techniques on the main PCB itself. There is no need for new tooling, thereby saving money if customization is required.

The PA.760.A is manufactured in our IATF16949 approved production facility and made from highly reliable and robust ceramic that is currently used by world leading automotive manufacturers in extremely challenging environments.

The PA.760 has a small profile, 40\*6\*5mm, allowing for ease of integration. Contact your regional Taoglas customer support team to request these services or additional support to integrate and test this antenna's performance in your device.

## 2. Specifications

Electrical							
Band	Frequency (MHz)	Efficiency (%)	Average Gain (dB)	Peak Gain (dBi)	Impedance	Polarization	Radiation Pattern
<b>5G NR/4G</b> Band 71	617~698	40.5	-3.9	-0.7	50 $\Omega$	Linear	Omni
<b>4G/3G</b> Band 12,13,14,17,28,29	698~806	49.6	-3.1	0.5			
<b>4G/3G</b> Band 5,8,18,19,20,26,27	824~960	53.2	-2.7	1			
<b>5G NR/4G</b> Band 21,32,74,75,76	1427~1518	28.8	-5.4	-0.5			
<b>4G/3G</b> Band 1,2,3,4,9,23,25,35,39,66	1710~2200	66.8	-1.7	3.4			
<b>4G/3G</b> Band 7,38,41	2490~2690	53.8	-2.7	2.9			
<b>5G NR</b> Band 22,42,48,77,78	3300~3500	42.6	-3.7	4.3			
<b>LTE5200/ Wi-Fi 5800</b>	5150~5925	51.5	-2.9	3			

\*The PA.760.A antenna performance was measured on a 120x45 ground plane (PAD.760.A)

Mechanical	
Dimensions	40*6*5mm
Material	Ceramic
Termination	Ag (environmental Pb free) - Solder Pad
EVB Connector	SMA-Female
Weight	3g
Environmental	
Temperature Range	-40°C to 85°C
Humidity	Non-condensing 65°C 95% RH

5G/4G Bands			
Band Number	5G NR / FR1 / LTE / LTE-Advanced / WCDMA / HSPA / HSPA+ / TD-SCDMA		
	Uplink	Downlink	Covered
1	UL: 1920 to 1980	DL: 2110 to 2170	✓
2	UL: 1850 to 1910	DL: 1930 to 1990	✓
3	UL: 1710 to 1785	DL: 1805 to 1880	✓
4	UL: 1710 to 1755	DL: 2110 to 2155	✓
5	UL: 824 to 849	DL: 869 to 894	✓
7	UL: 2500 to 2570	DL: 2620 to 2690	✓
8	UL: 880 to 915	DL: 925 to 960	✓
9	UL: 1749.9 to 1784.9	DL: 1844.9 to 1879.9	✓
11	UL: 1427.9 to 1447.9	DL: 1475.9 to 1495.9	✓
12	UL: 699 to 716	DL: 729 to 746	✓
13	UL: 777 to 787	DL: 746 to 756	✓
14	UL: 788 to 798	DL: 758 to 768	✓
17	UL: 704 to 716	DL: 734 to 746	✓
18	UL: 815 to 830	DL: 860 to 875	✓
19	UL: 830 to 845	DL: 875 to 890	✓
20	UL: 832 to 862	DL: 791 to 821	✓
21	UL: 1447.9 to 1462.9	DL: 1495.9 to 1510.9	✓
22	UL: 3410 to 3490	DL: 3510 to 3590	✓
23	UL: 2000 to 2020	DL: 2180 to 2200	✓
24	UL: 1625.5 to 1660.5	DL: 1525 to 1559	✓
25	UL: 1850 to 1915	DL: 1930 to 1995	✓
26	UL: 814 to 849	DL: 859 to 894	✓
27	UL: 807 to 824	DL: 852 to 869	✓
28	UL: 703 to 748	DL: 758 to 803	✓
29	UL: -	DL: 717 to 728	✓
30	UL: 2305 to 2315	DL: 2350 to 2360	✓
31	UL: 452.5 to 457.5	DL: 462.5 to 467.5	✗
32	UL: -	DL: 1452 – 1496	✓
35		1850 to 1910	✓
38		2570 to 2620	✓
39		1880 to 1920	✓
40		2300 to 2400	✓
41		2496 to 2690	✓
42		3400 to 3600	✓
43		3600 to 3800	✓
48		3550 to 3700	✓
66	UL: 1710-1780	DL: 2110-2200	✓
71		617 to 698	✓
74/75/76		1427 to 1518	✓
77		3300 to 4200	✓
78		3300 to 3800	✓
79		4400 to 5000	✓

### 3. Antenna Characteristics

#### 3.1 Return Loss

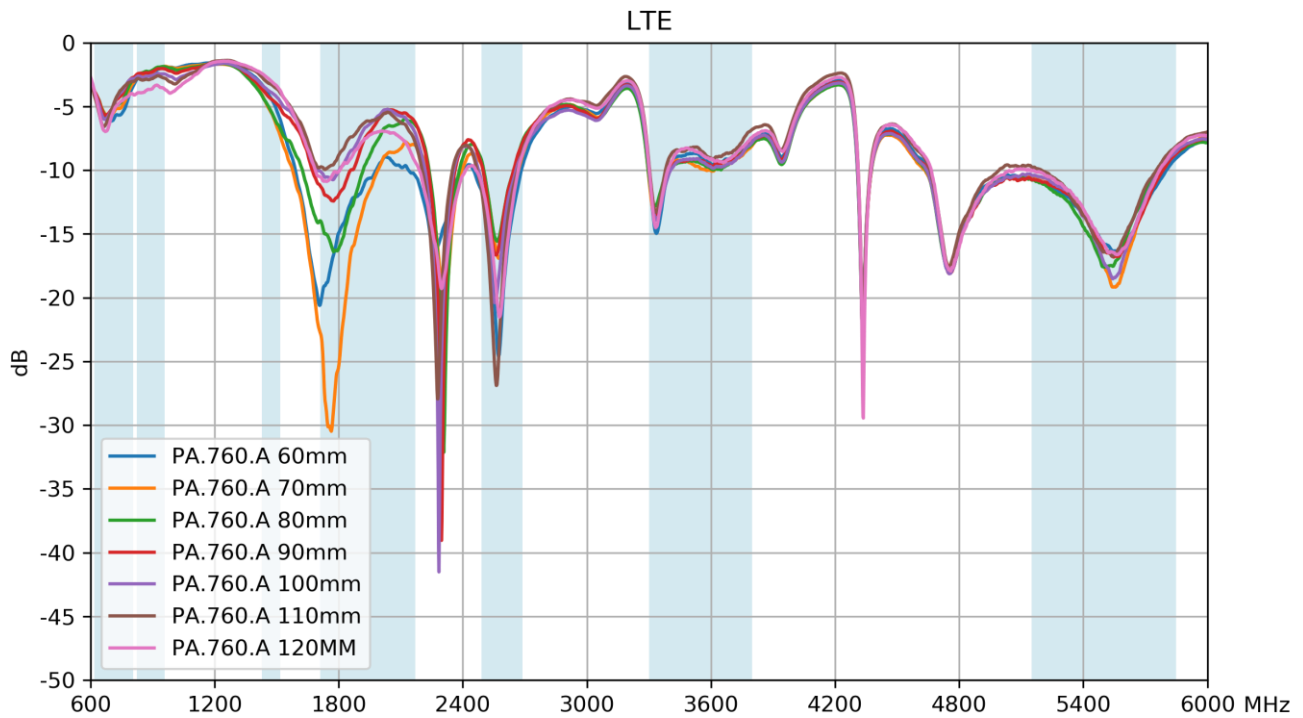

#### 3.2 Efficiency

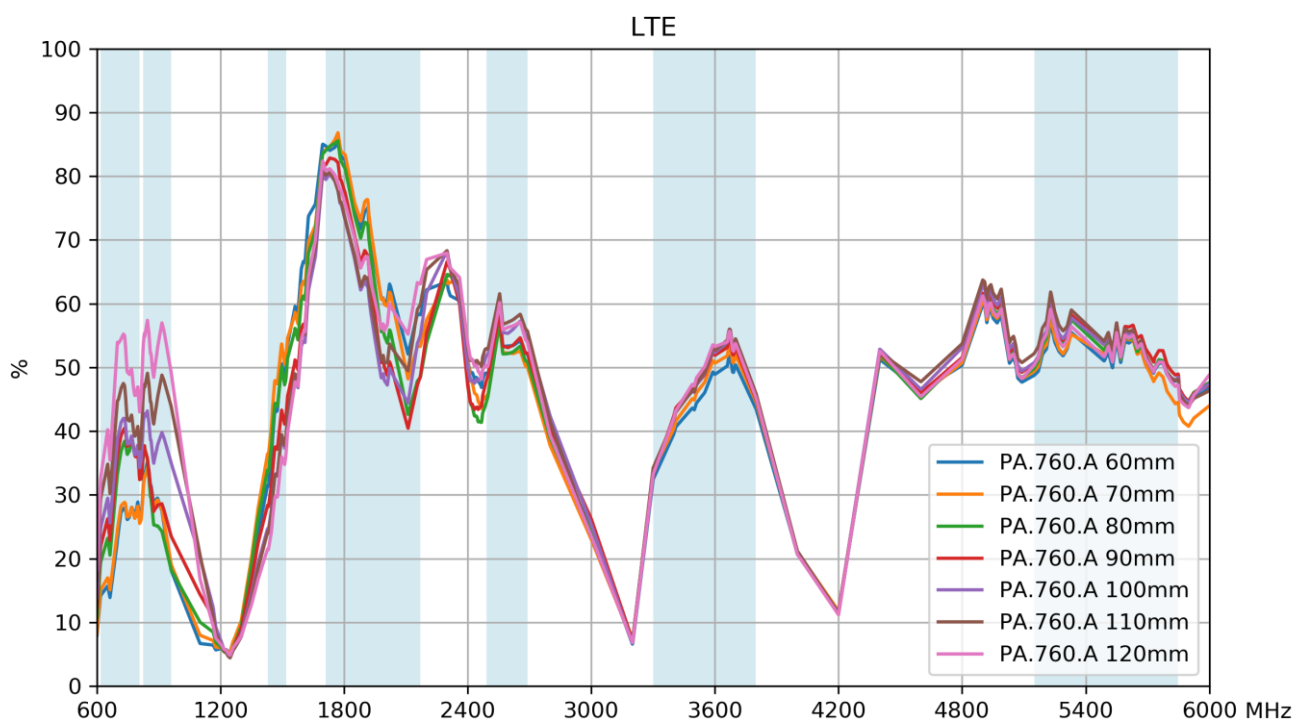

### 3.3 Average Gain

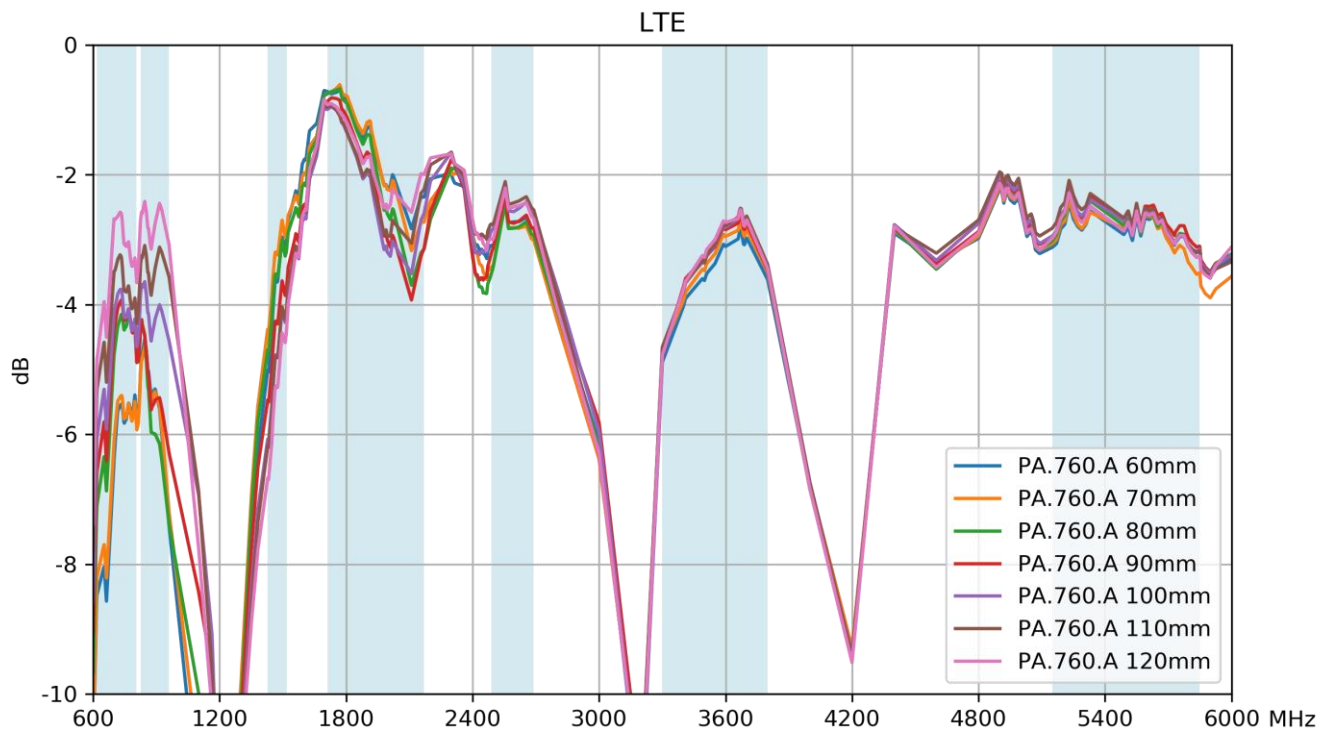

### 3.4 Peak Gain

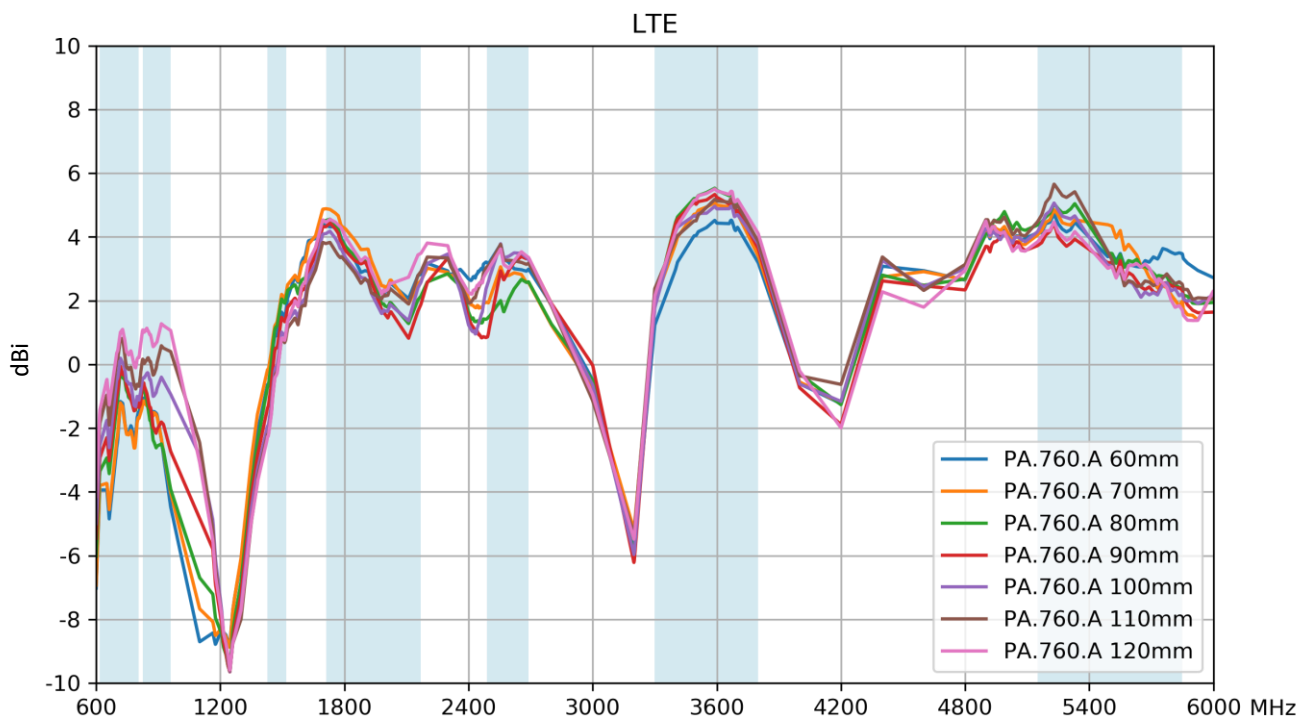



## 4. 2D Radiation Patterns

### 4.1 Test Setup

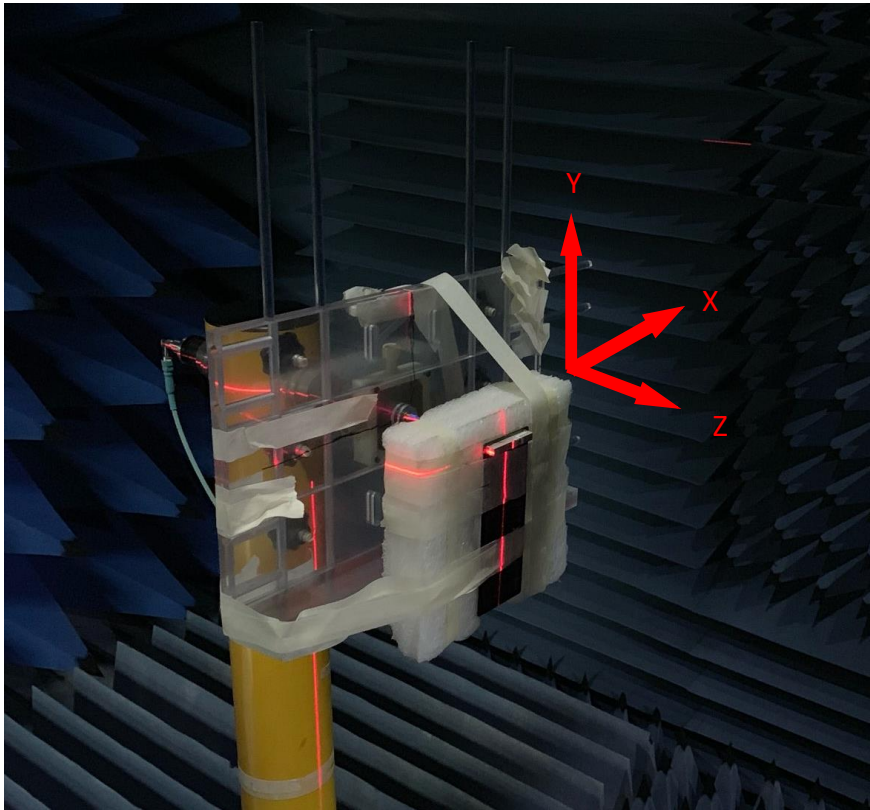

Tested on PAD.760.A Evaluation board(120x45mm)



## 4.2 On Evaluation Board 120\*45mm 2D & 3D Radiation Patterns

600MHz

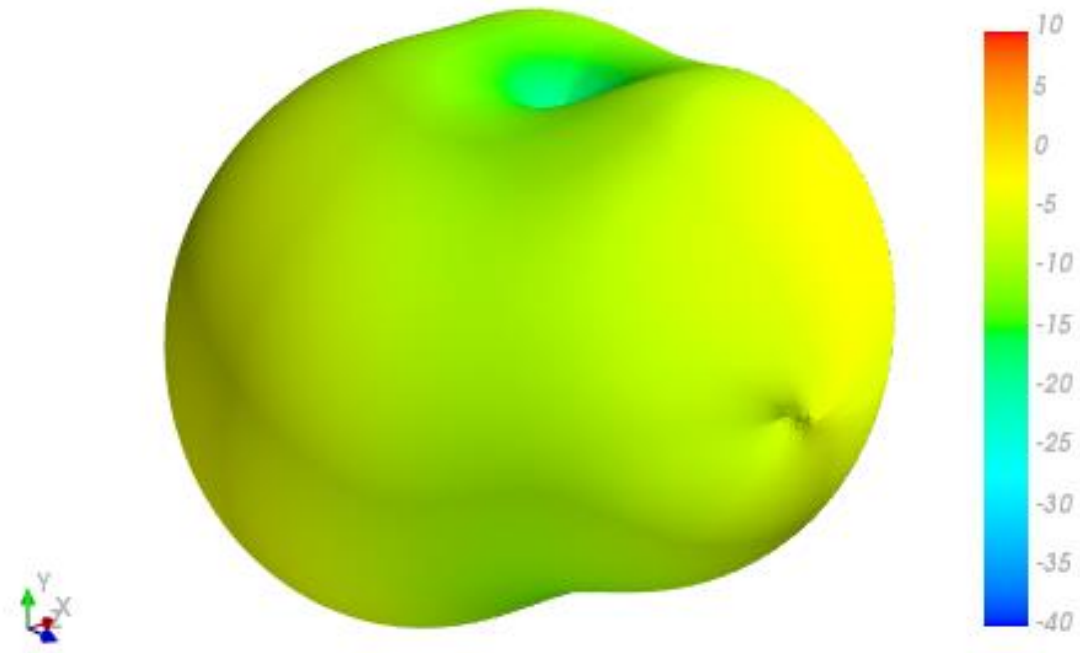

XY Plane

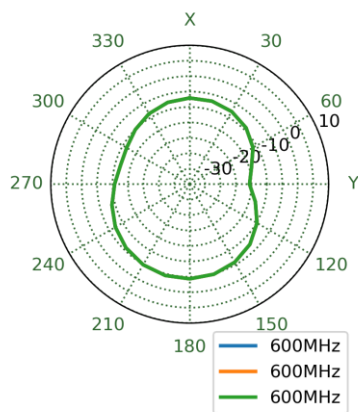

XZ Plane

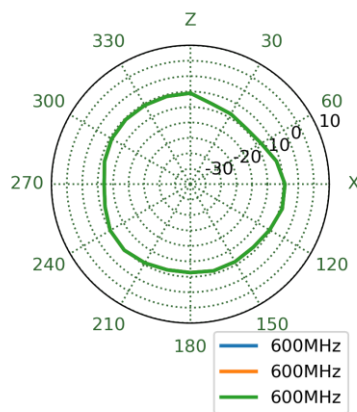

YZ Plane

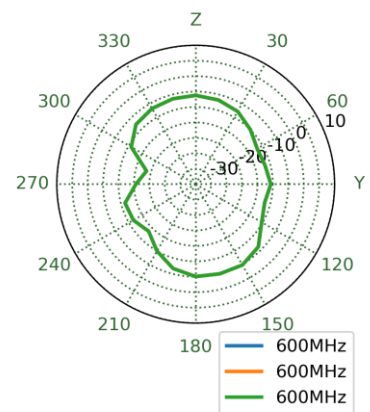

652MHz

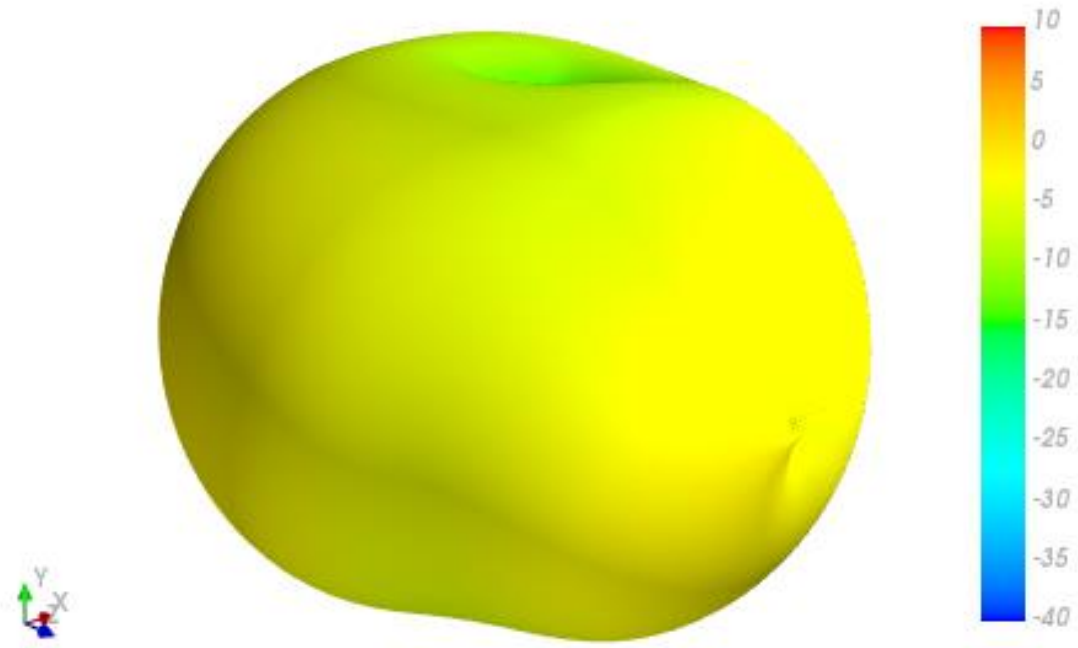

XY Plane

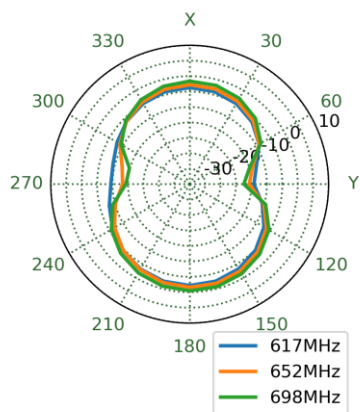

XZ Plane

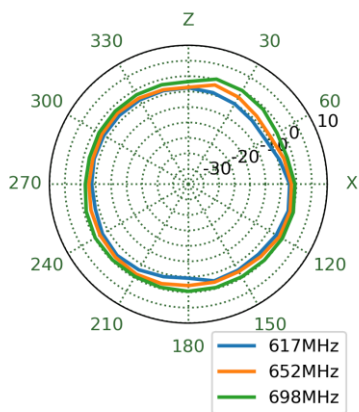

YZ Plane

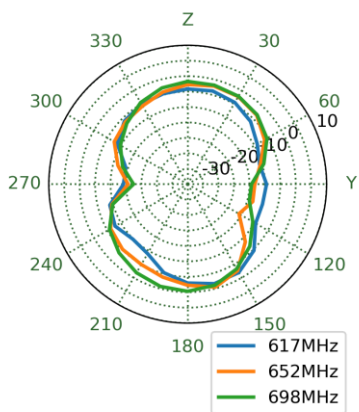

751MHz

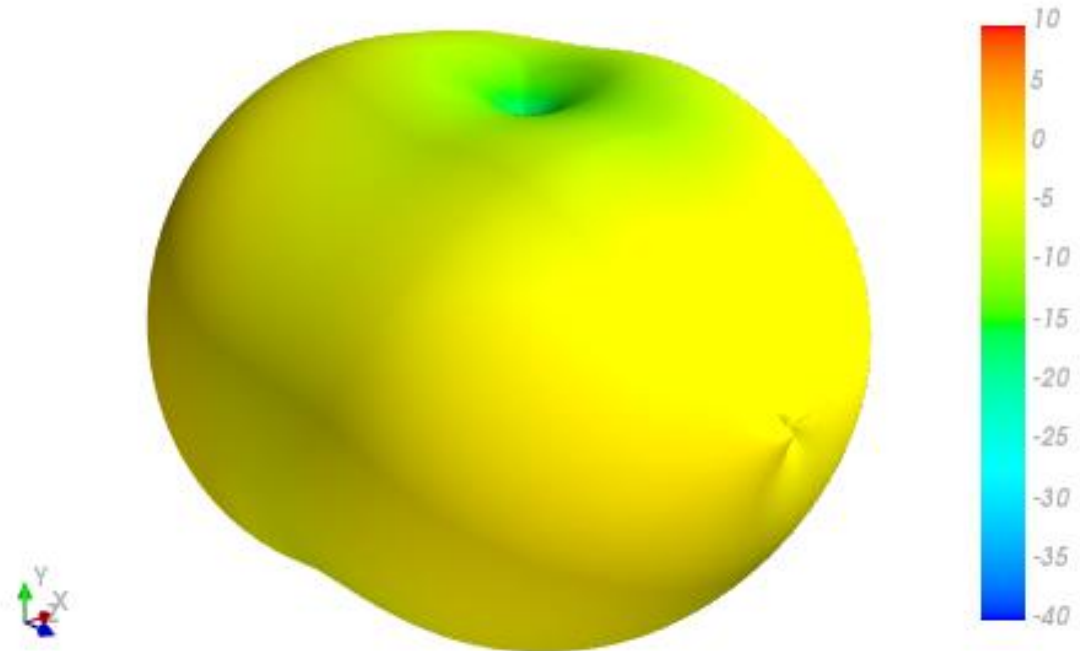

XY Plane      XZ Plane      YZ Plane

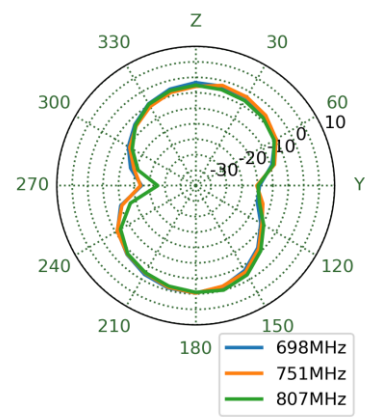
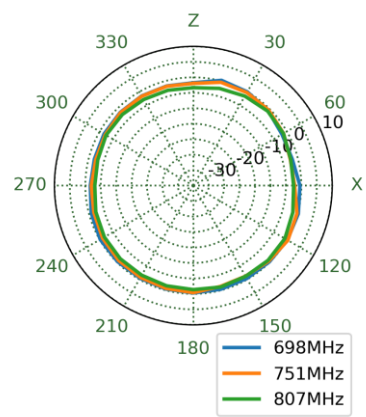
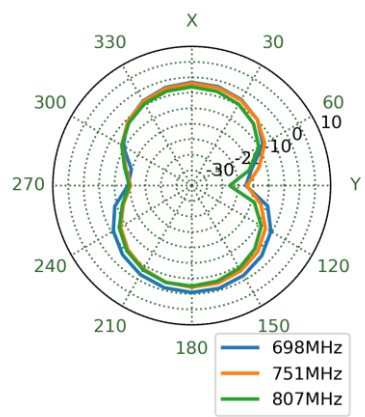

890MHz

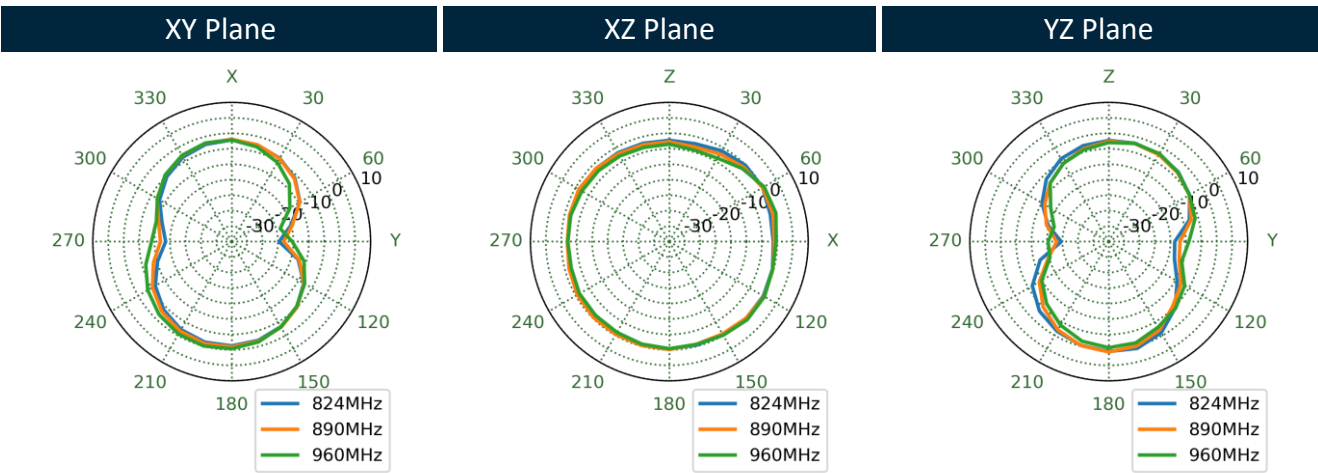
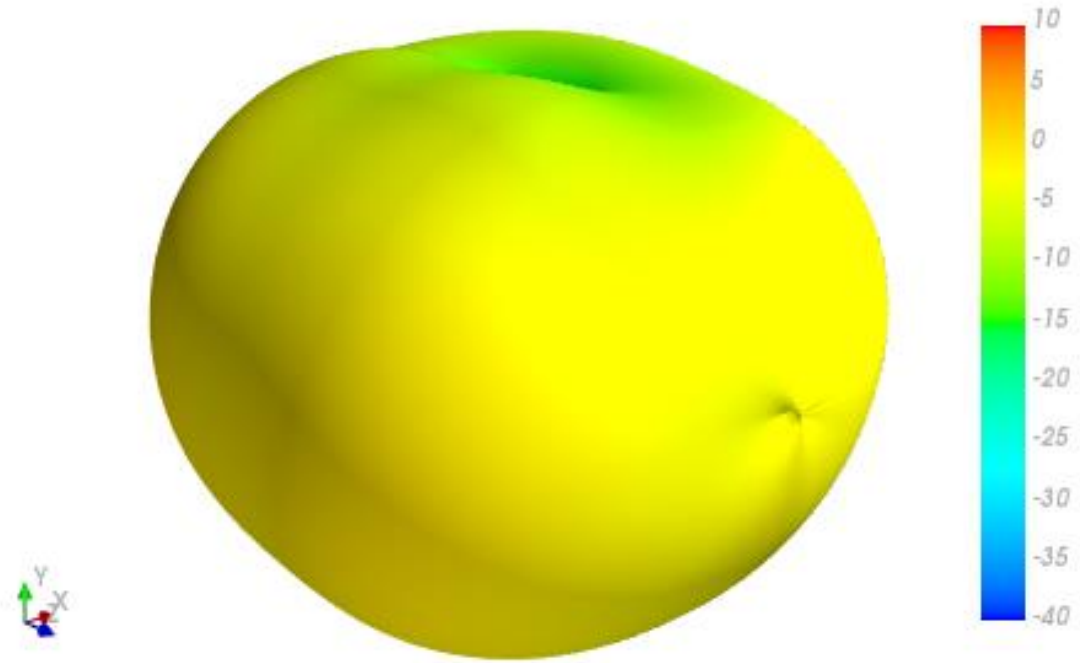

1470MHz

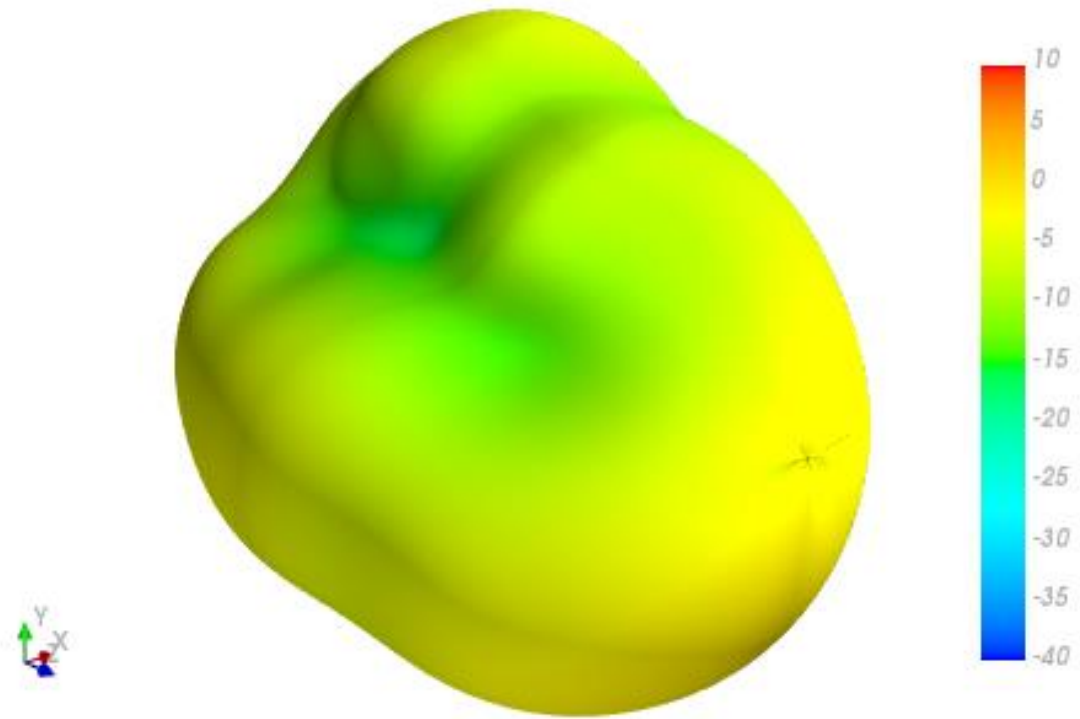

XY Plane

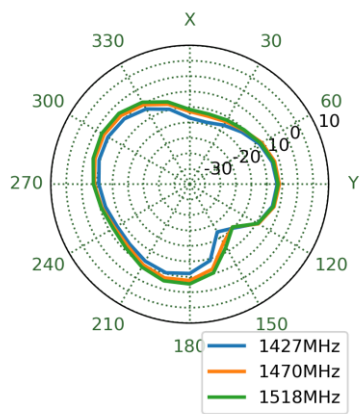

XZ Plane

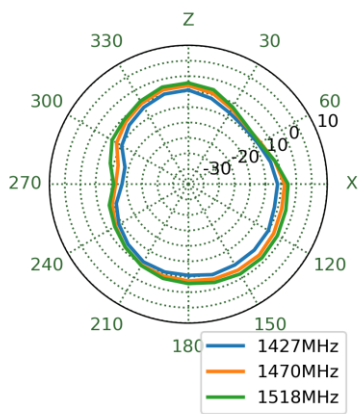

YZ Plane

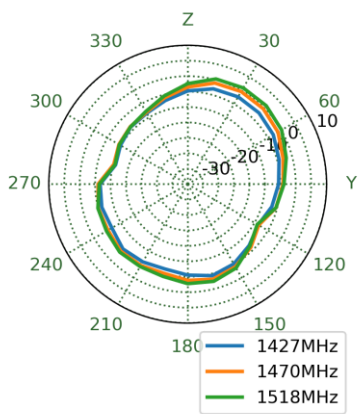

1805MHz

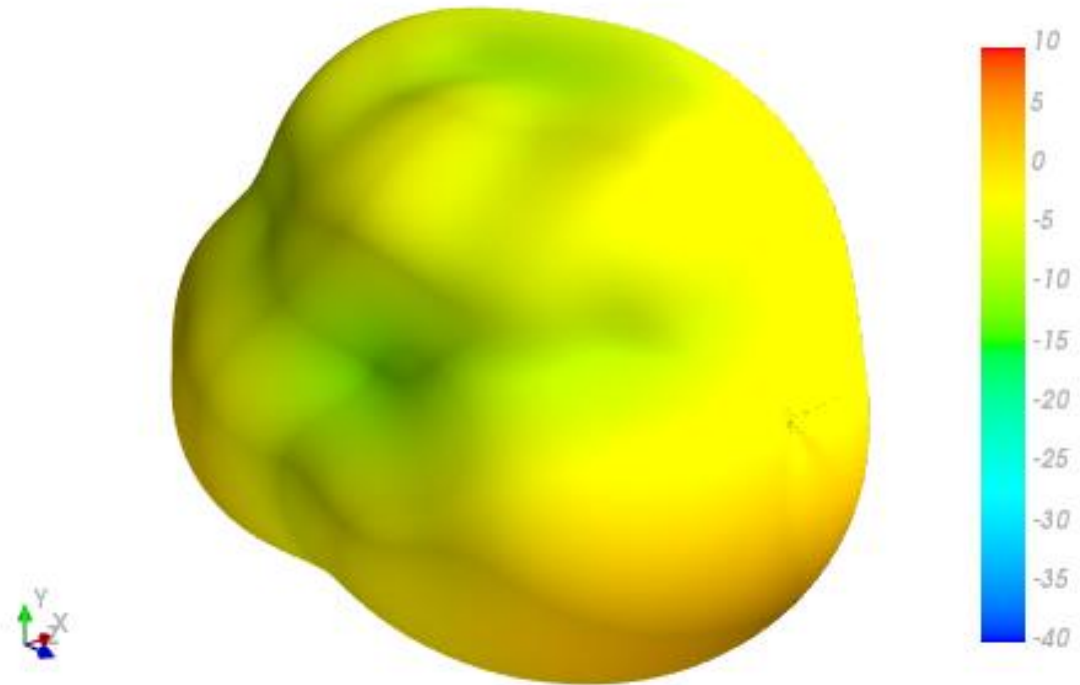

XY Plane

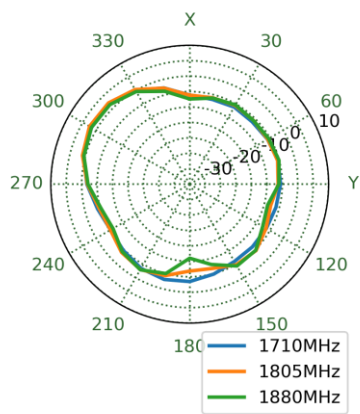

XZ Plane

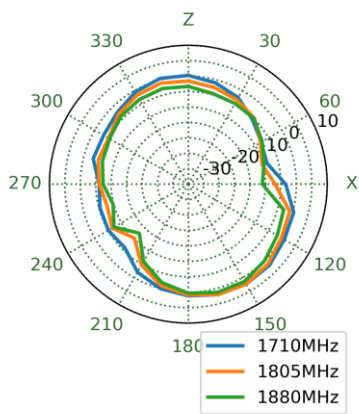

YZ Plane

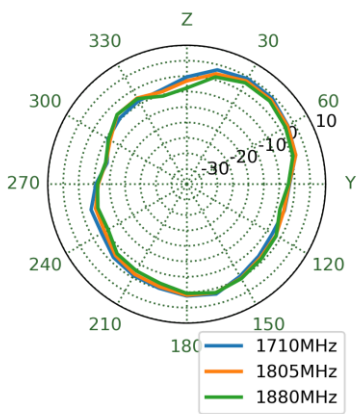

1920MHz

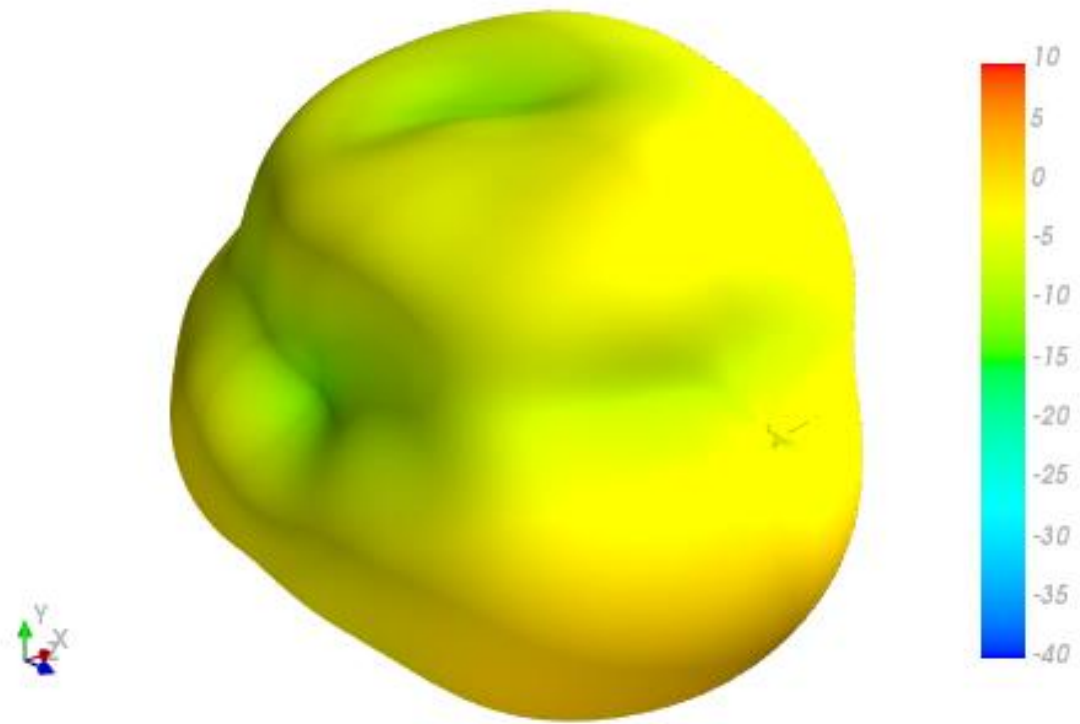

XY Plane

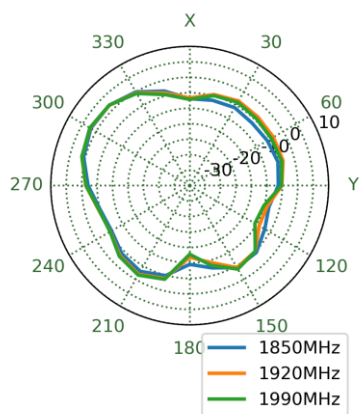

XZ Plane

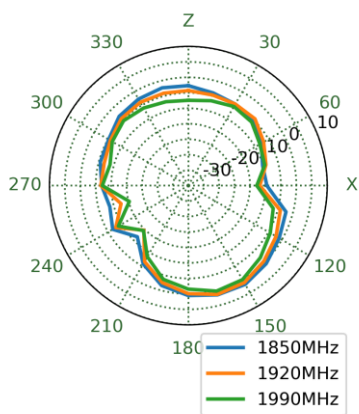

YZ Plane

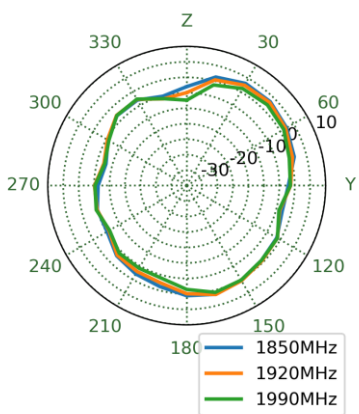



# 1990MHz

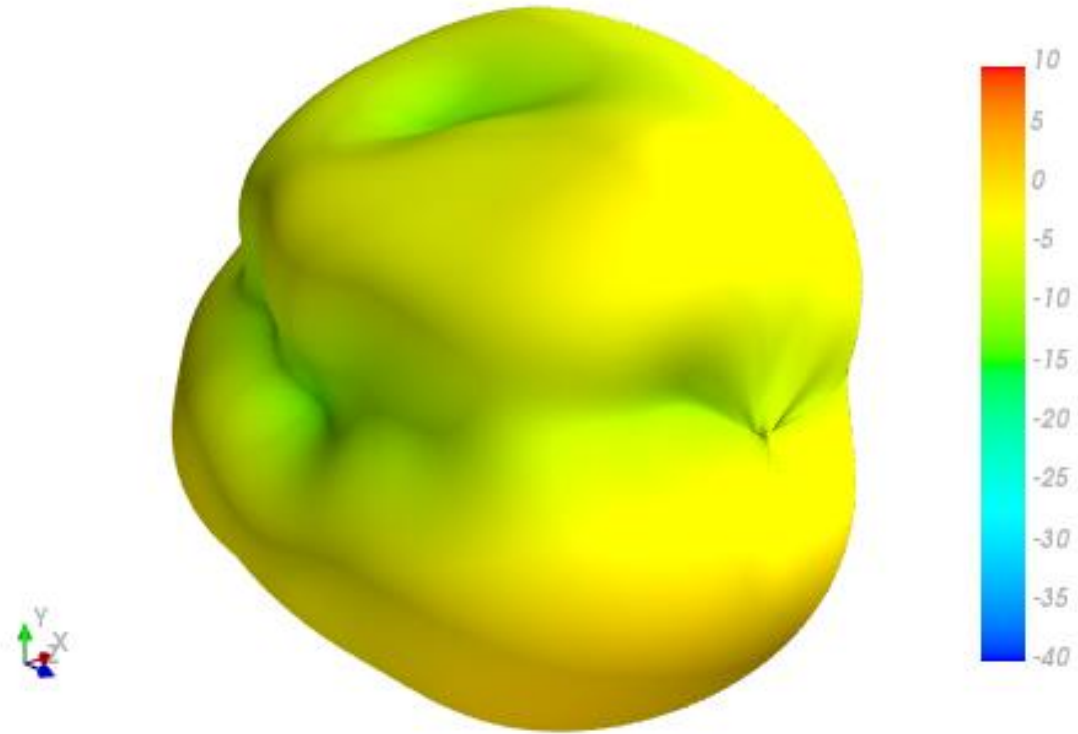

XY Plane
XZ Plane
YZ Plane

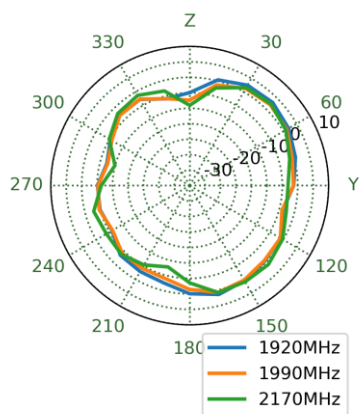
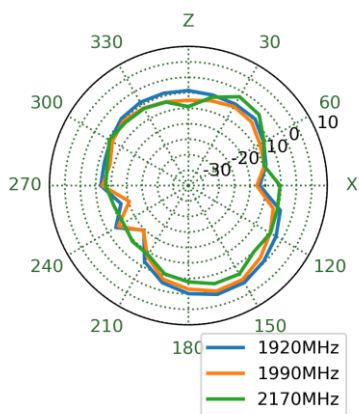
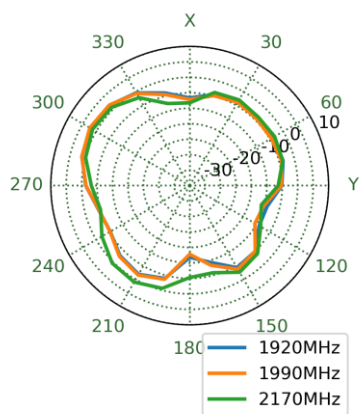

2595MHz

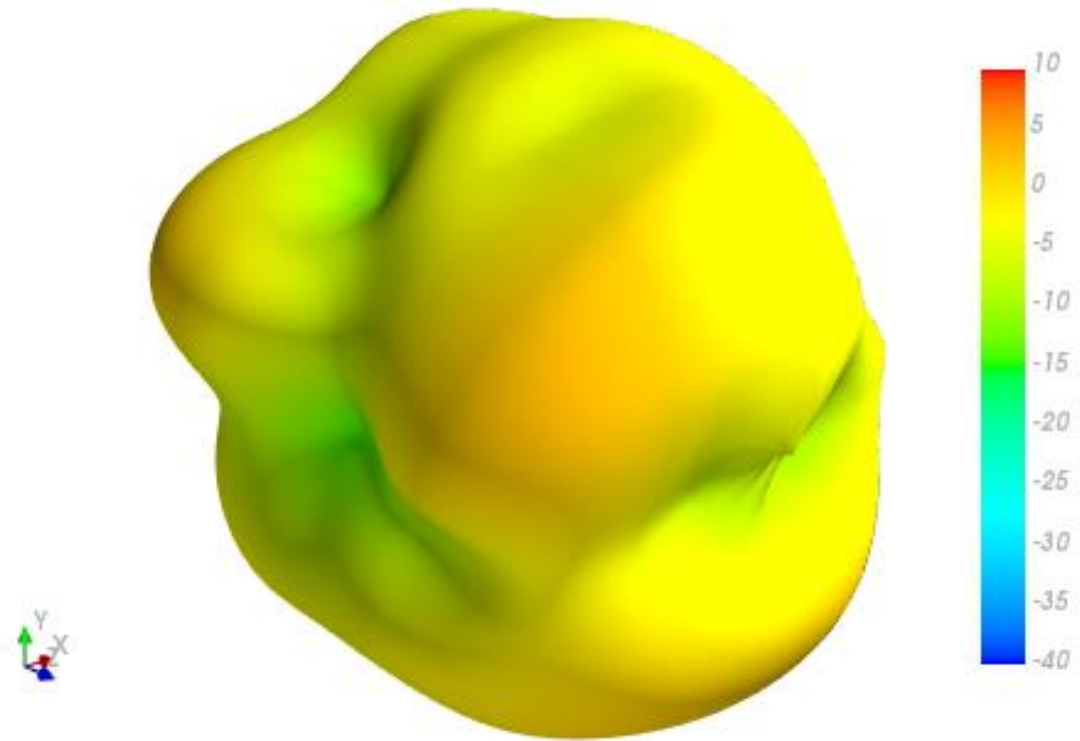

XY Plane

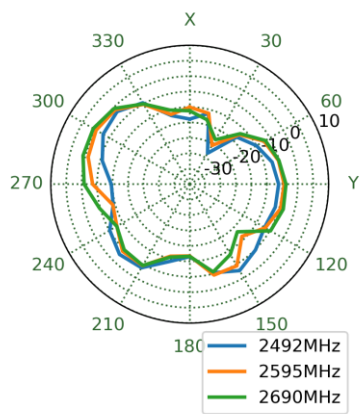

XZ Plane

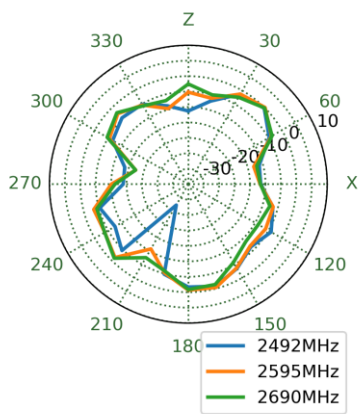

YZ Plane

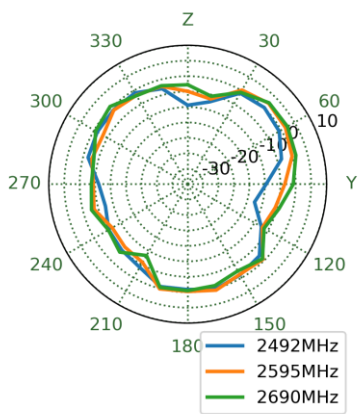

3550MHz

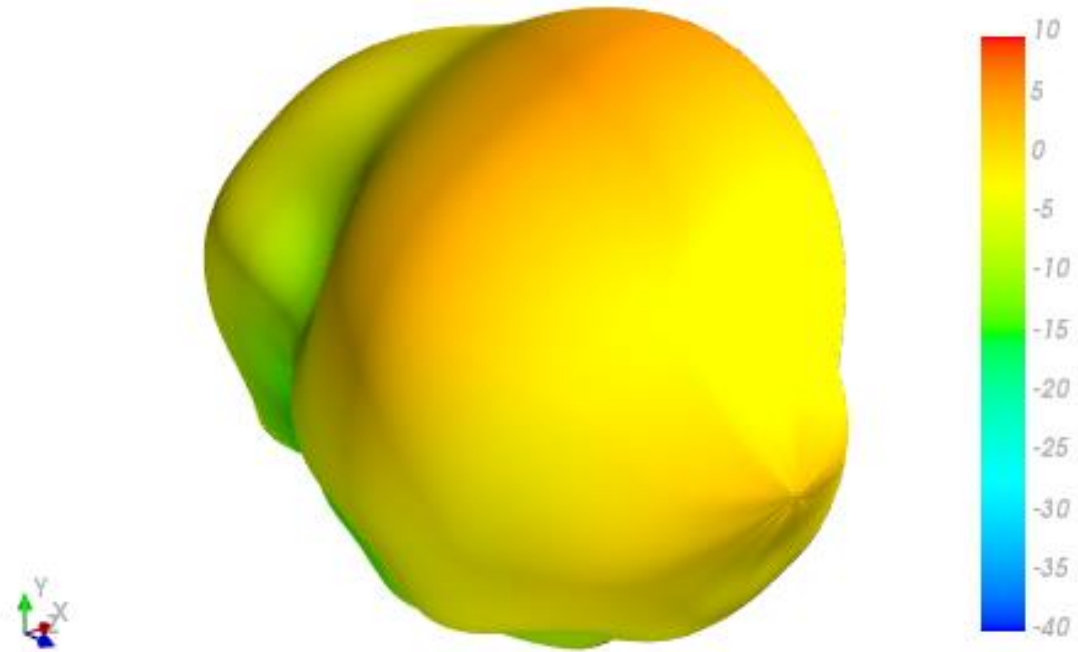

XY Plane

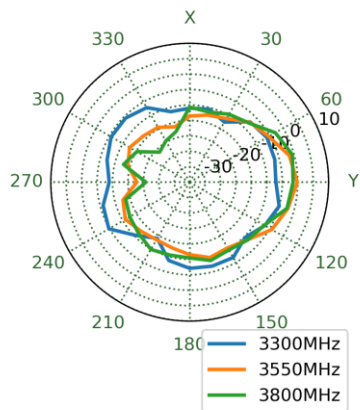

XZ Plane

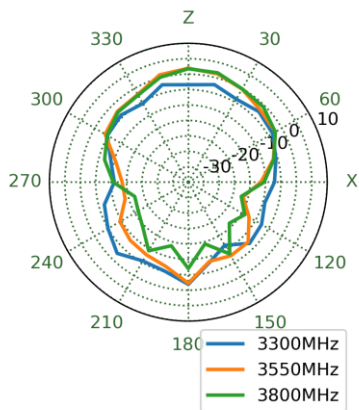

YZ Plane

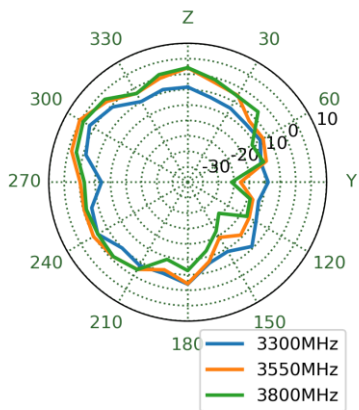

# 5530MHz

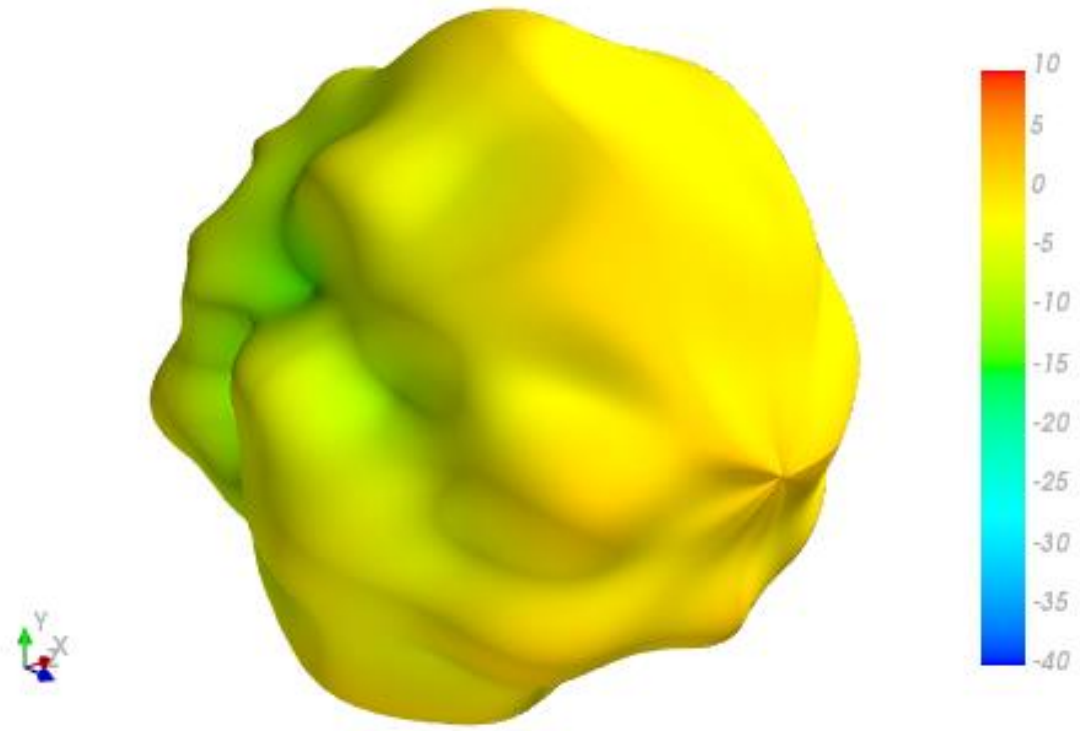

XY Plane

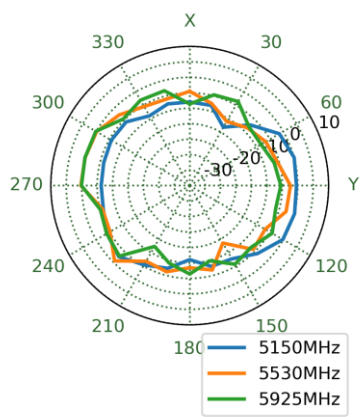

XZ Plane

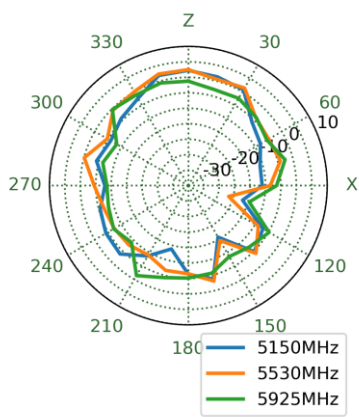

YZ Plane

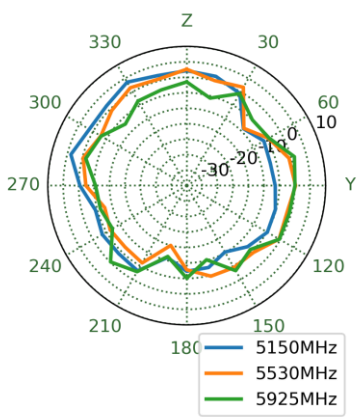

# 5. Mechanical Drawing (Units: mm)

## 5.1 Antenna Drawing

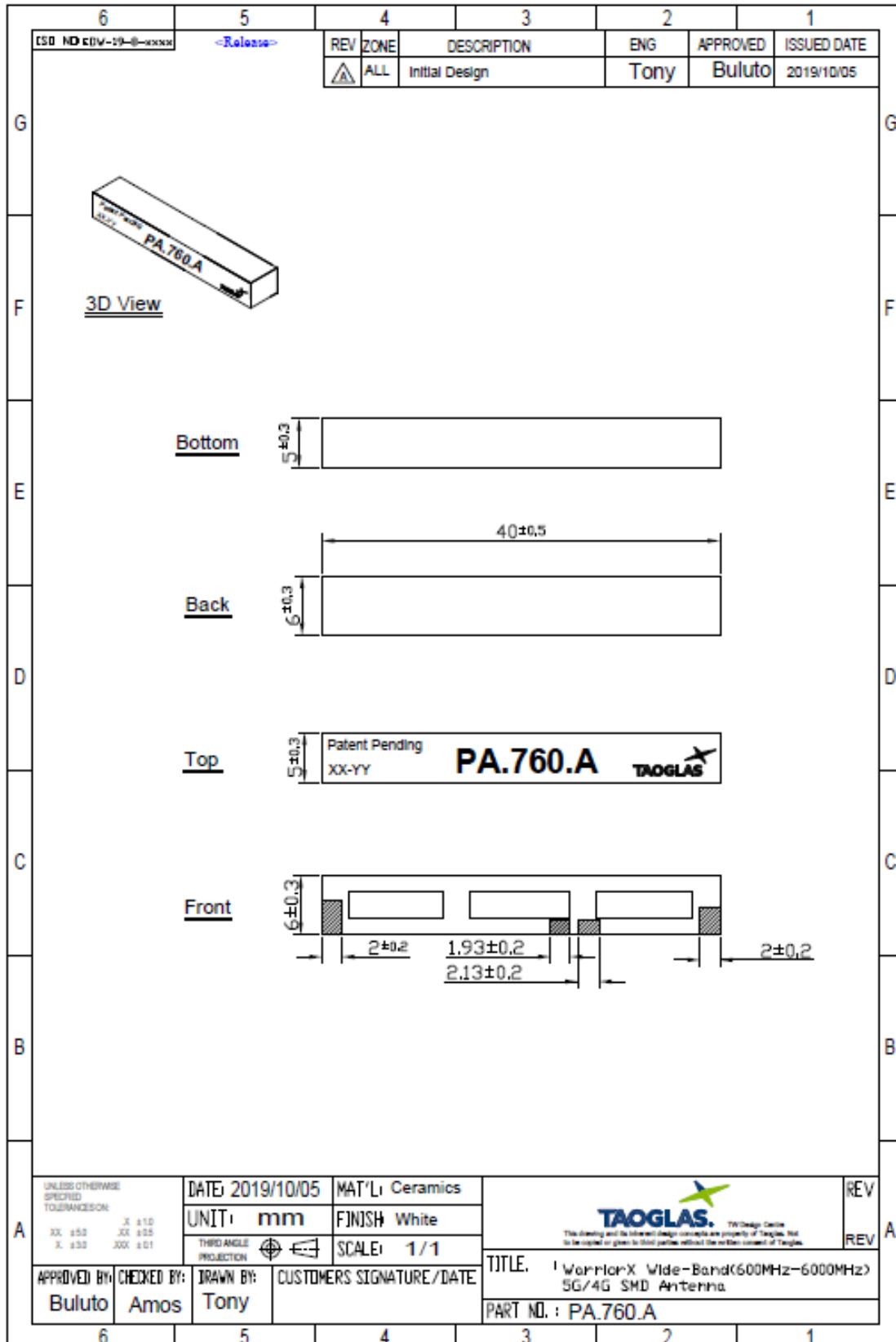

## 5.2 Paste Area

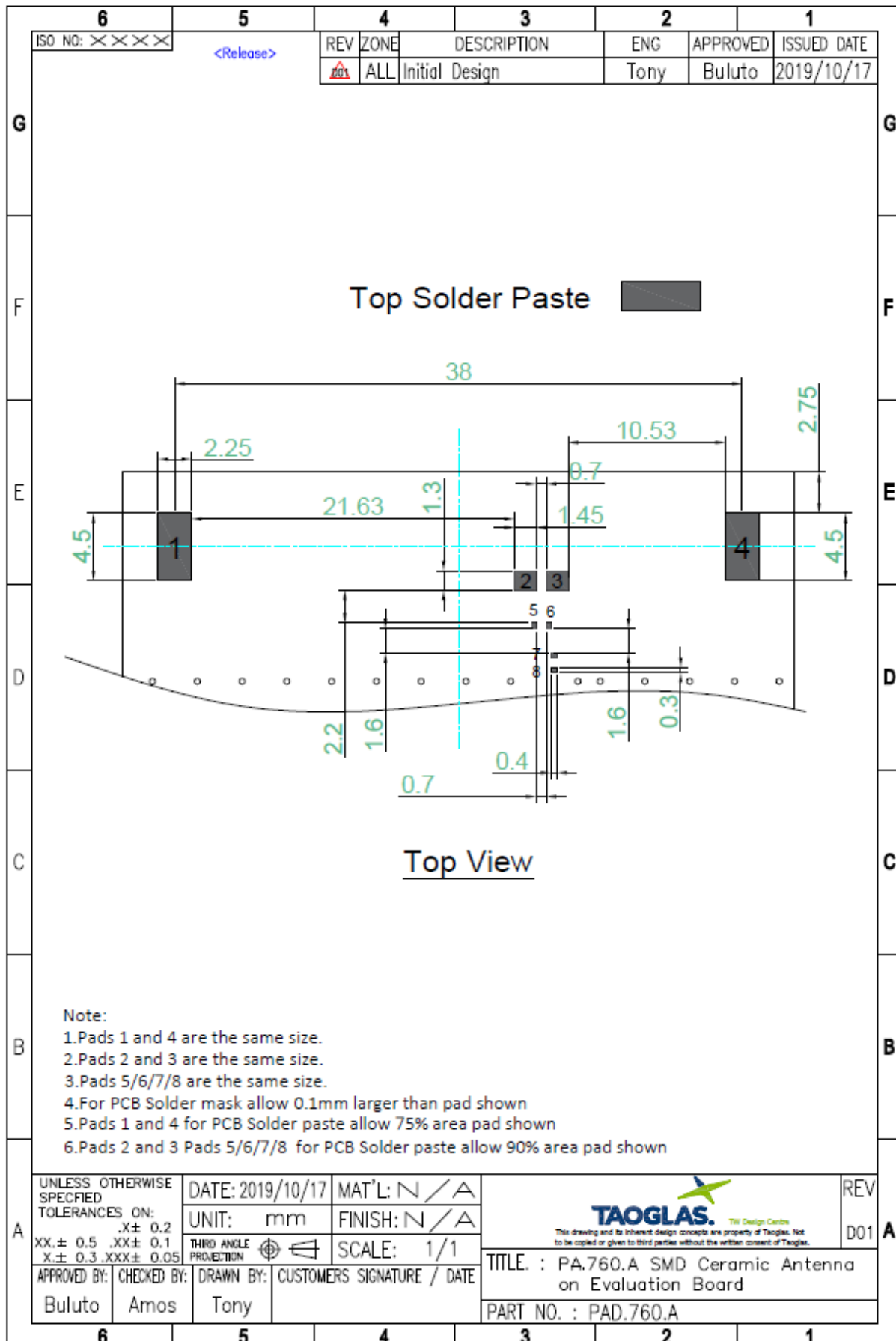

5.3 Copper Keep-Out Areas

Top Layer

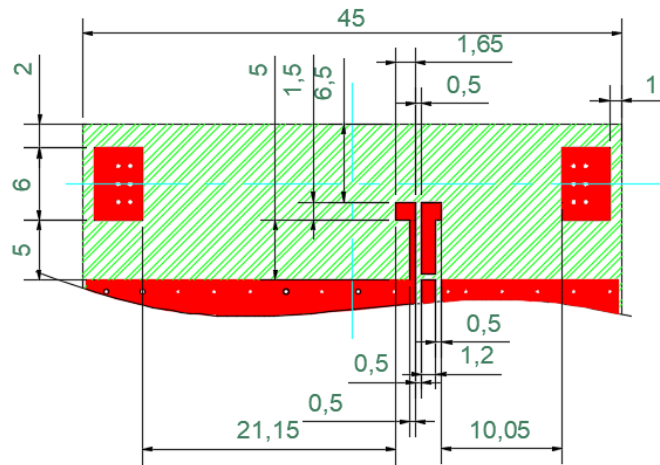

Top View

Bottom Layer

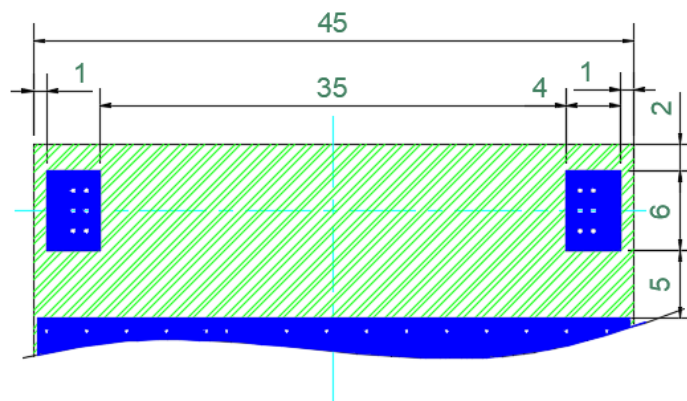

Bottom View

Note:

- 1. Copper area
- 2. Ground Clearance Area



## 5.4 Solder Layer

### Top Solder Paste

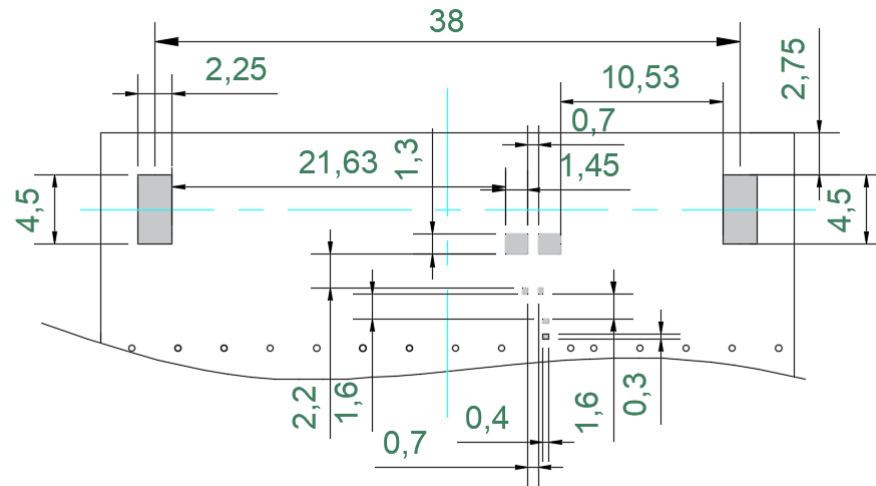

### Top View

### Top Solder Mask

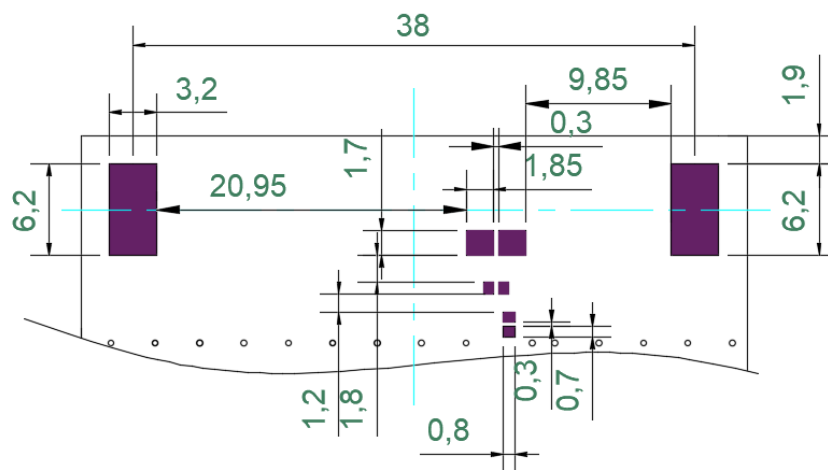

### Top View

#### Note:

- 1. Top Solder Paste
- 2. Top Solder Mask

## 5.5 Evaluation Board

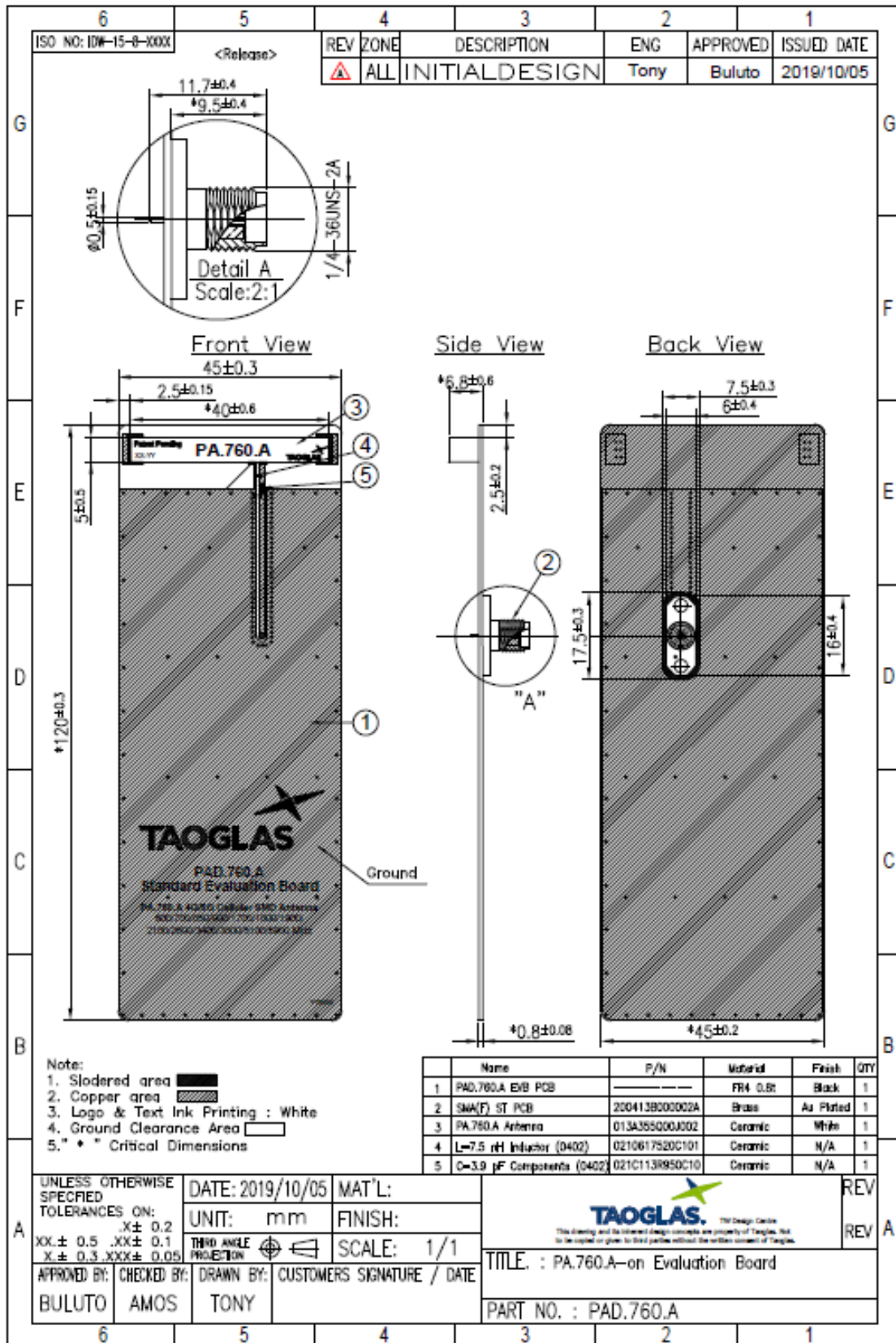

## 5.6 Footprint Dimensions

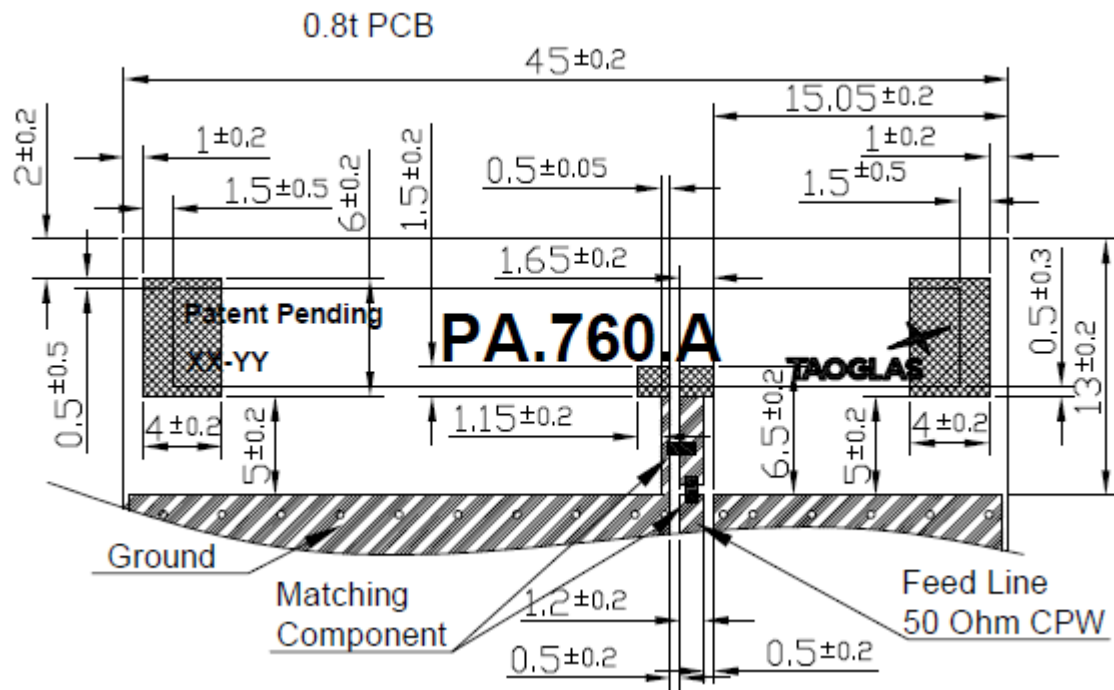

## 6. Evaluation Board Matching Circuit

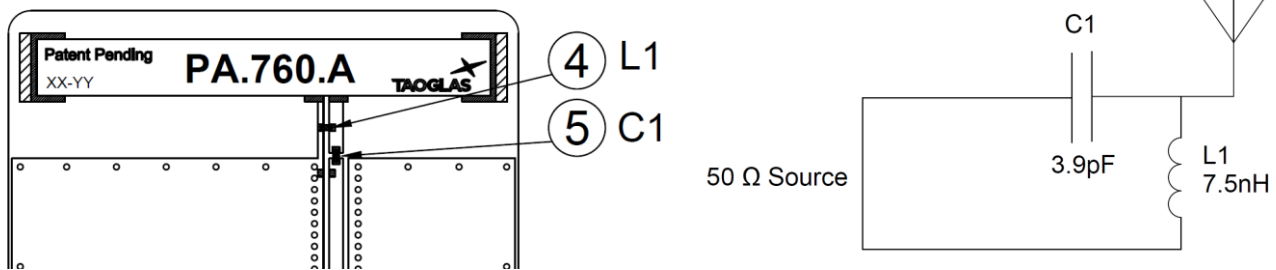

Circuit Symbol	Size	Description
L1	0402	7.5nH inductor ±5%/SMD0402/Murata/LQG15HS7N5J02D
C1	0402	3.9pF Capacitor 50V/±0.25PF/MURATA

## 7. Packaging

450 pc PA.760.A per Tape & Reel

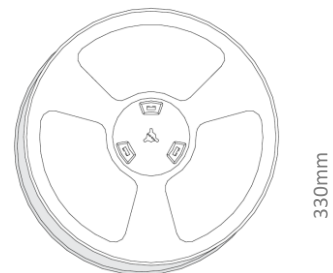

330mm

330mm

1 reel in small inner box  
Dimensions: 350\*350\*70mm  
Weight: 2.4Kg

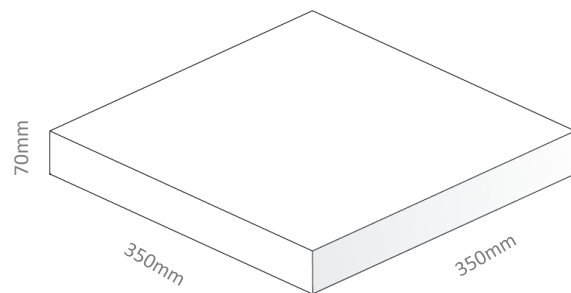

70mm

350mm

350mm

1350 pcs in one carton  
Dimensions: 370\*360\*275mm  
Weight: 7.5Kg

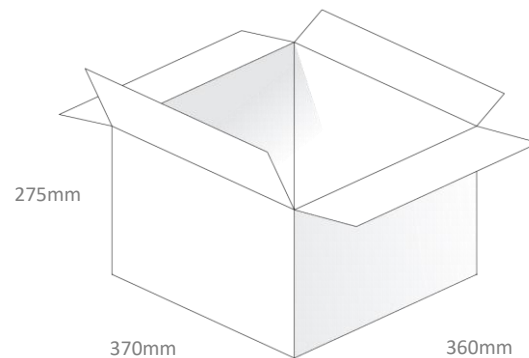

275mm

370mm

360mm

Pallet Dimensions:  
1110\*1320\*1100mm  
36 Cartons Per Pallet  
9 Cartons Per Layer, 4 Layers

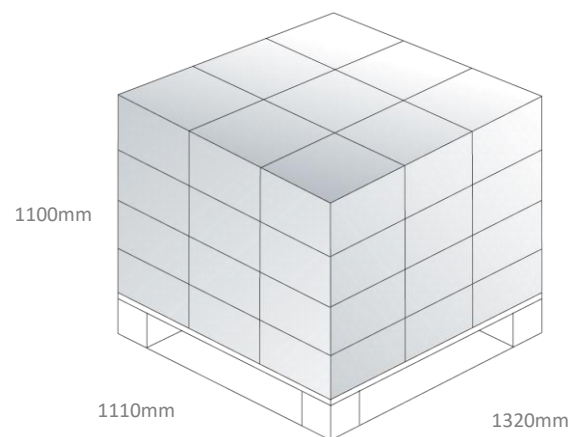

1100mm

1110mm

1320mm

## 8. Application Note

The PA.760.A has been tested on various size ground planes (180 to 50mm), see the below graphs for performance details.

### 8.1 Return Loss

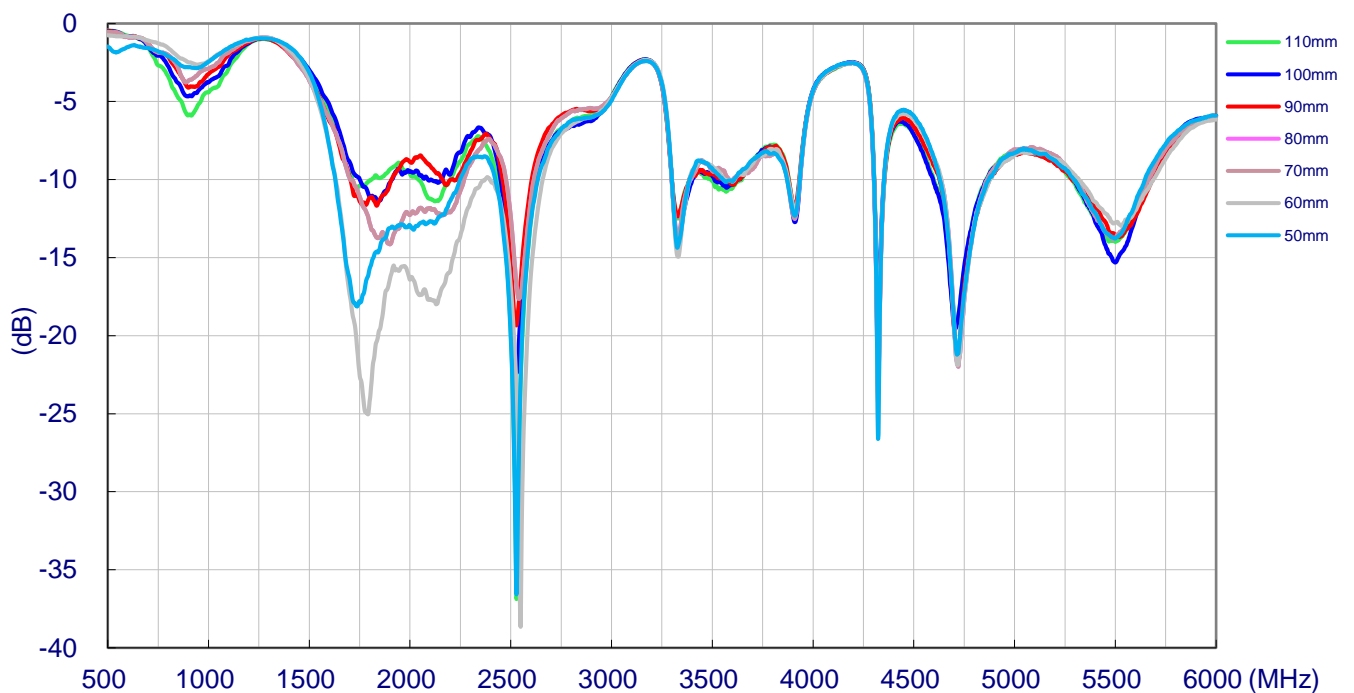
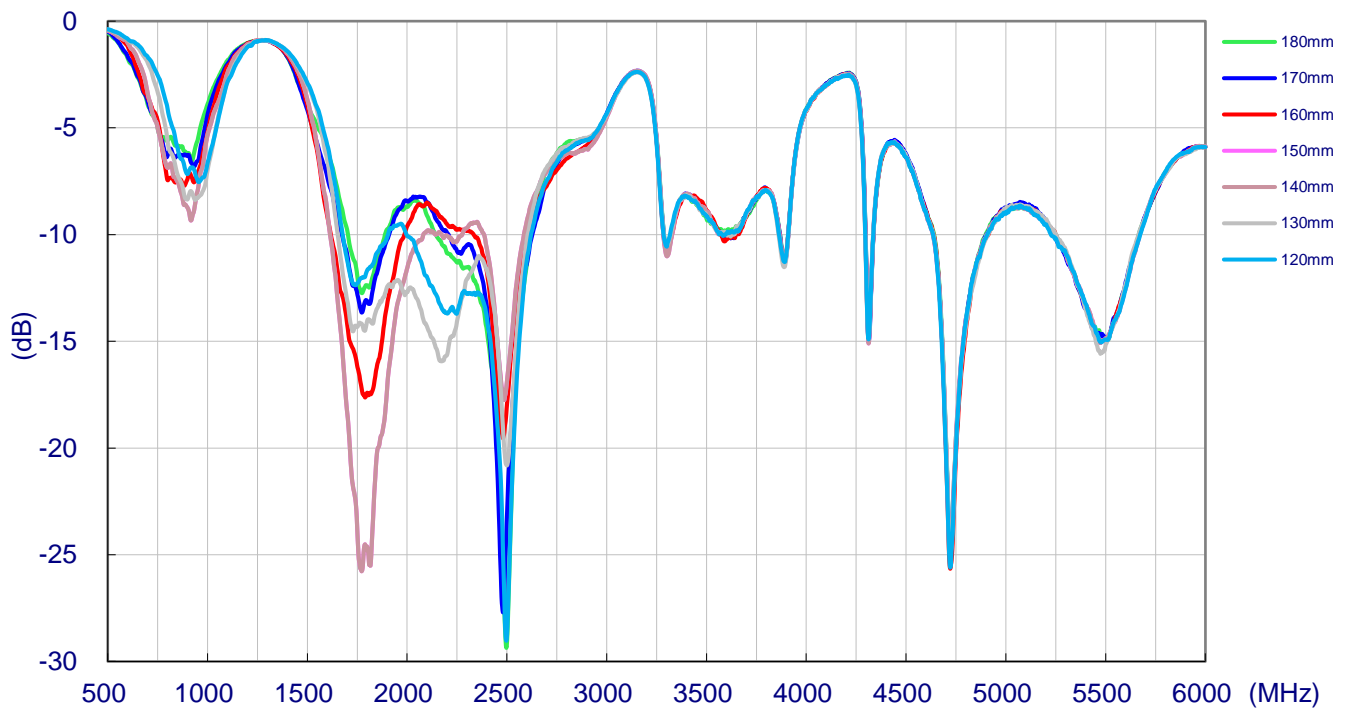

## 8.2 Efficiency

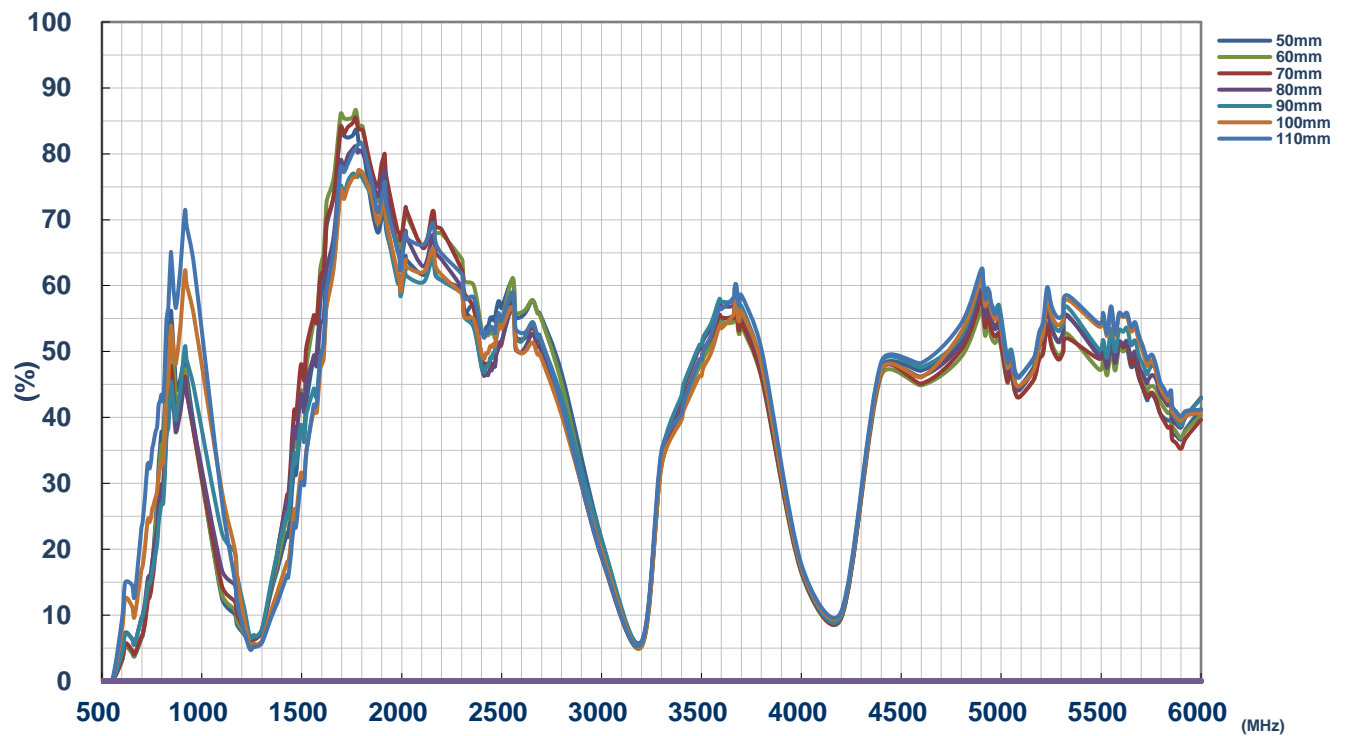
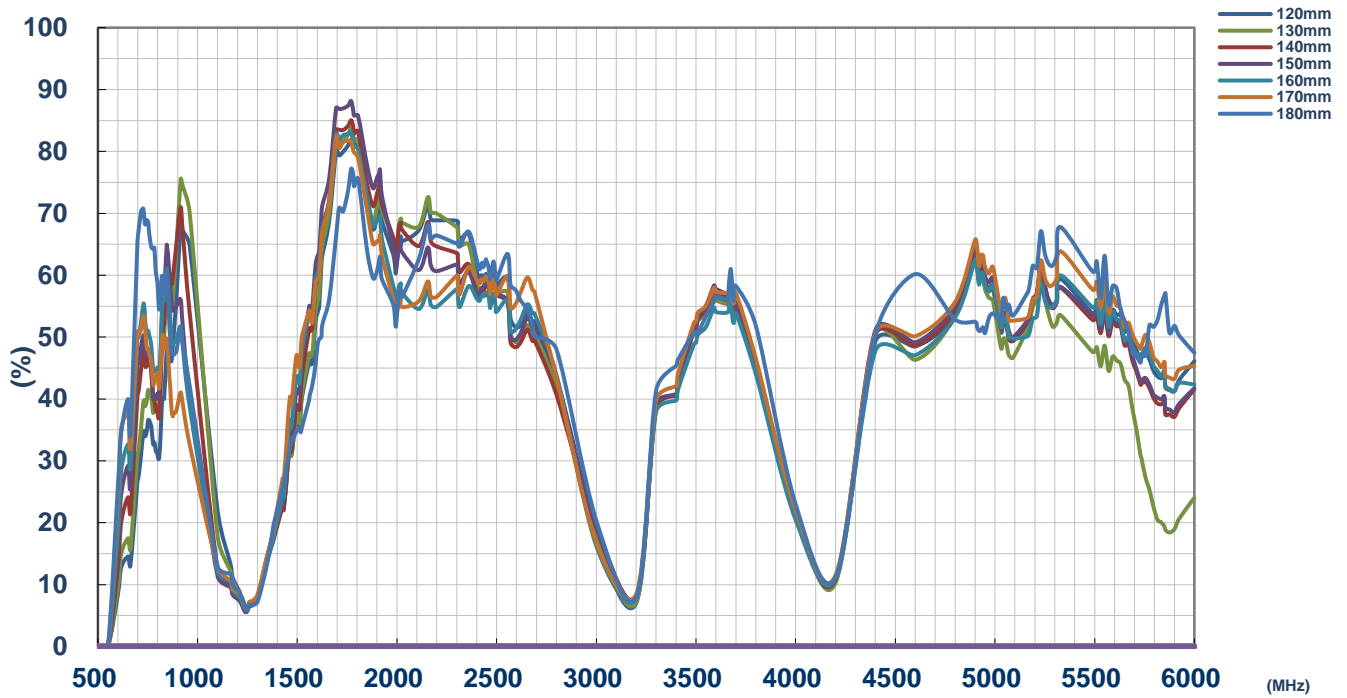



### 8.3 Average Gain

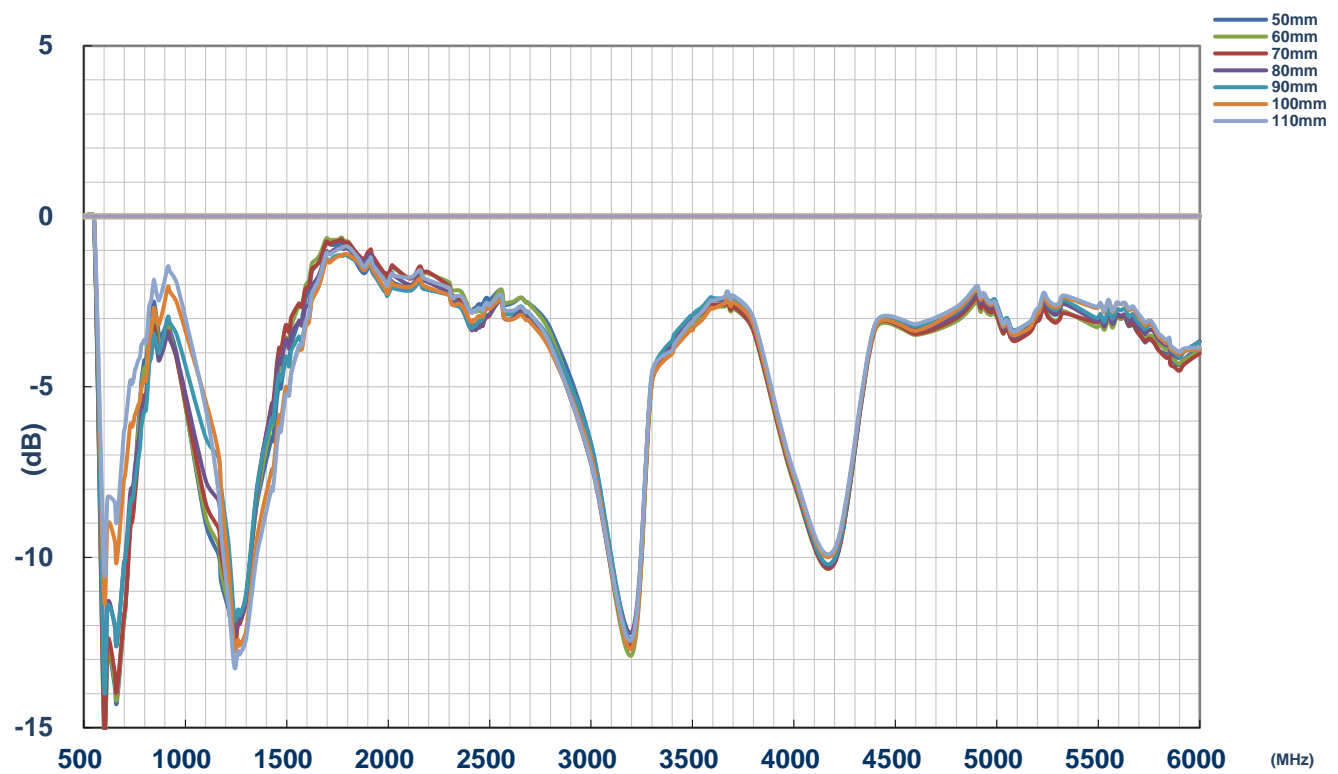
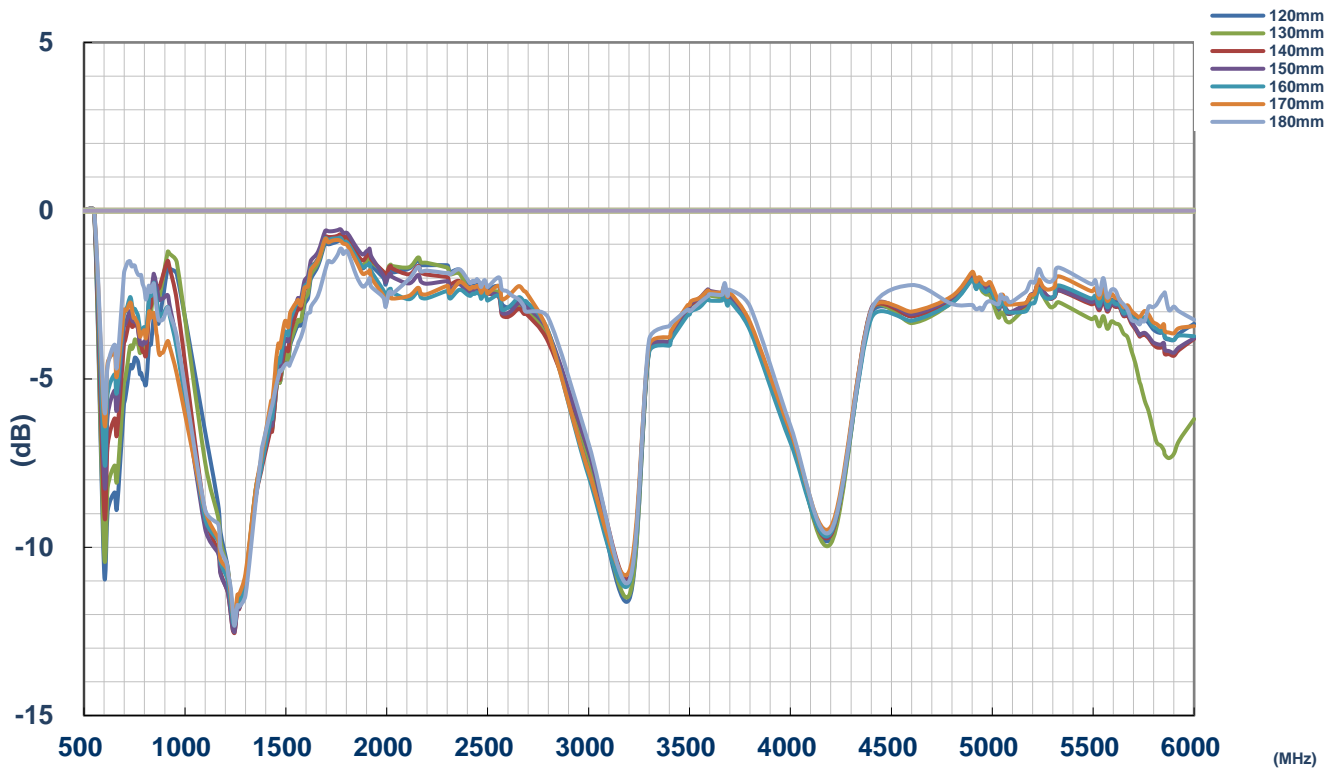

8.4 Peak Gain

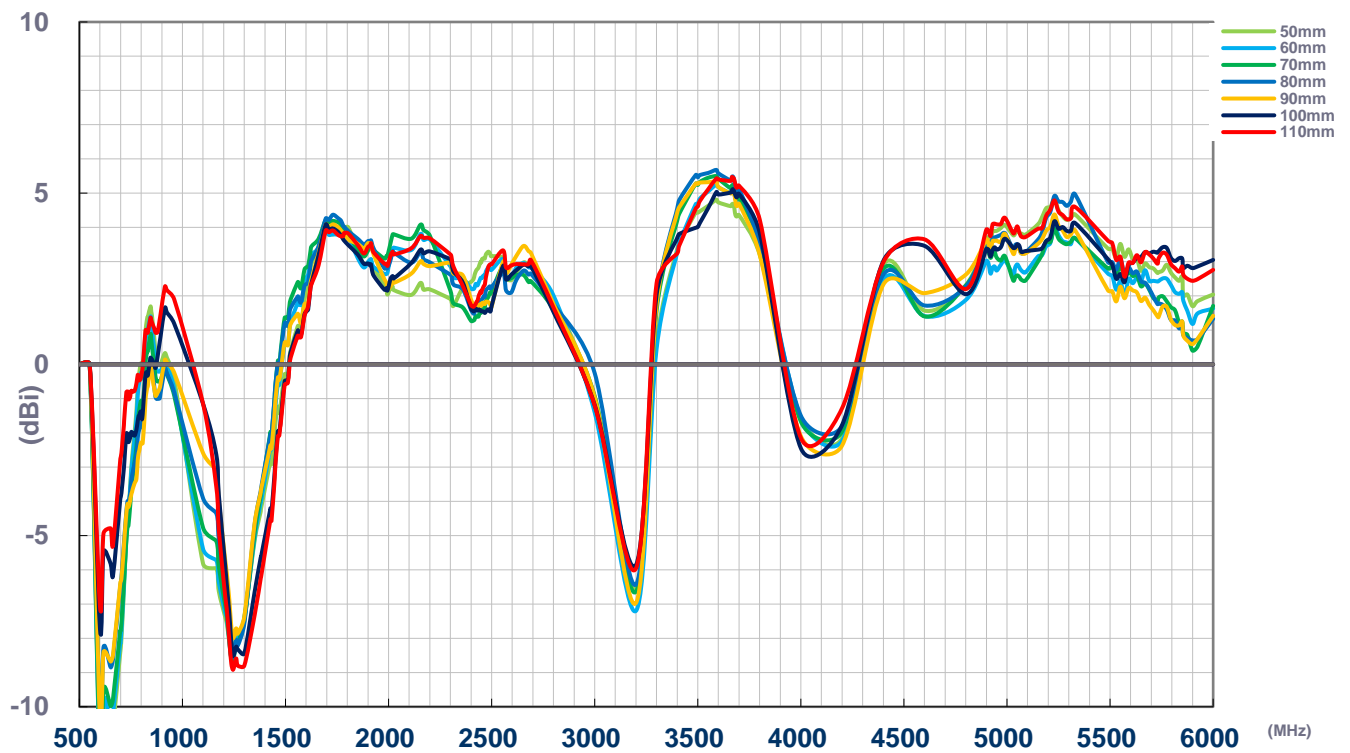
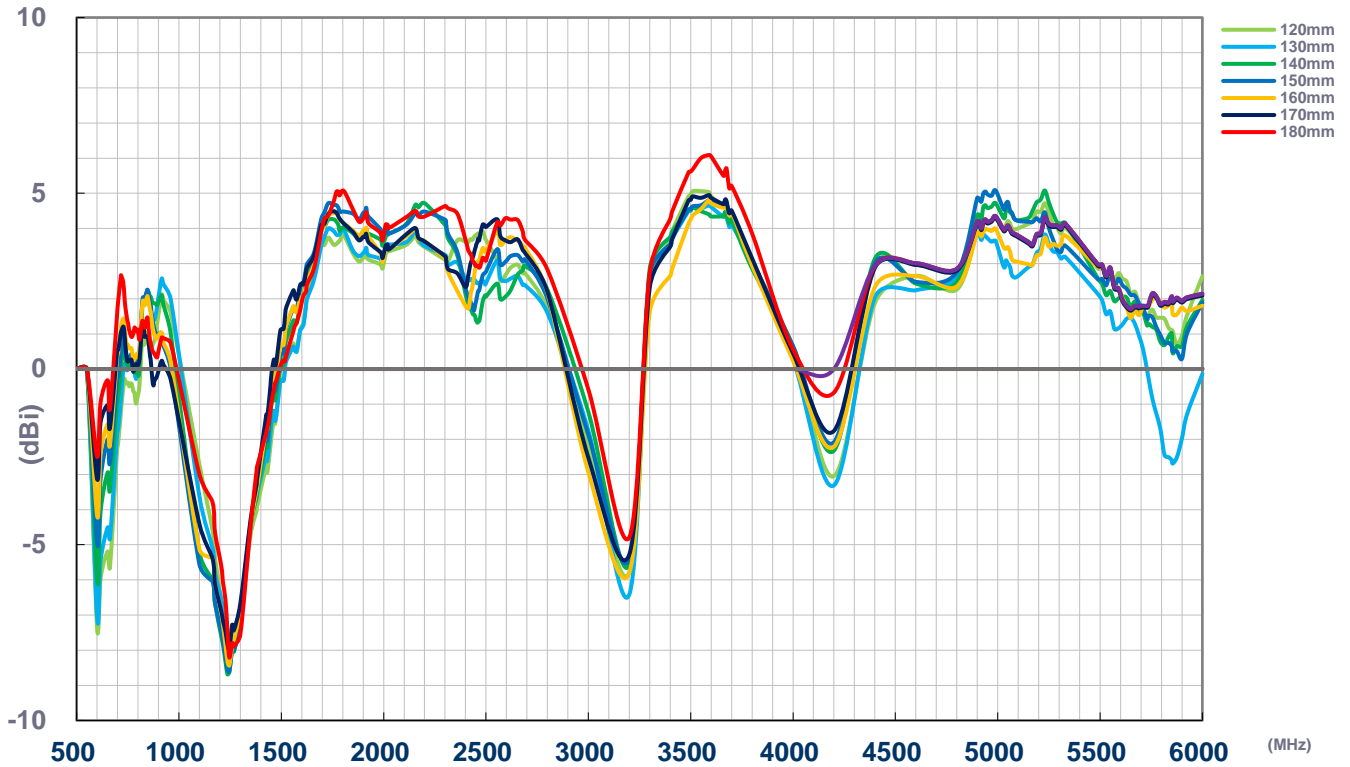

## 9. Solder Reflow Temperature

PA.760.A can be assembled following either Sn-Pb or Pb-Free assembly processes. The recommended soldering temperatures are as follows:

Phase	Profile Features	Sn-Pb Assembly	Pb-Free Assembly (SnAgCu)
Ramp-Up	Avg. Ramp-Up Rate (T <sub>smax</sub> to TP)	3°C/second (max)	3°C/second (max)
Preheat	Temperature Min (T <sub>smin</sub> )	100°	100°
	Temperature Max (T <sub>smax</sub> )	150°	150°
	Time (t <sub>smin</sub> to t <sub>smax</sub> )	60-120 seconds	60-120 seconds
Reflow	Temperature (T <sub>L</sub> )	183°C	217°C
	Total Time Above T <sub>L</sub> b(t <sub>L</sub> )	60-150 seconds	60-150 seconds
Peak	Temperature (T <sub>p</sub> )	235°C	260°C
	Time (t <sub>p</sub> )	10-30 seconds	20-40 seconds
Ramp-Down	Rate	6°C/second (max)	6°C/second (max)
Time from 25°C to peak Temperature		6 minutes max	8 minutes max

### Temperature profile – (green area) for the assembly process in reflow ovens

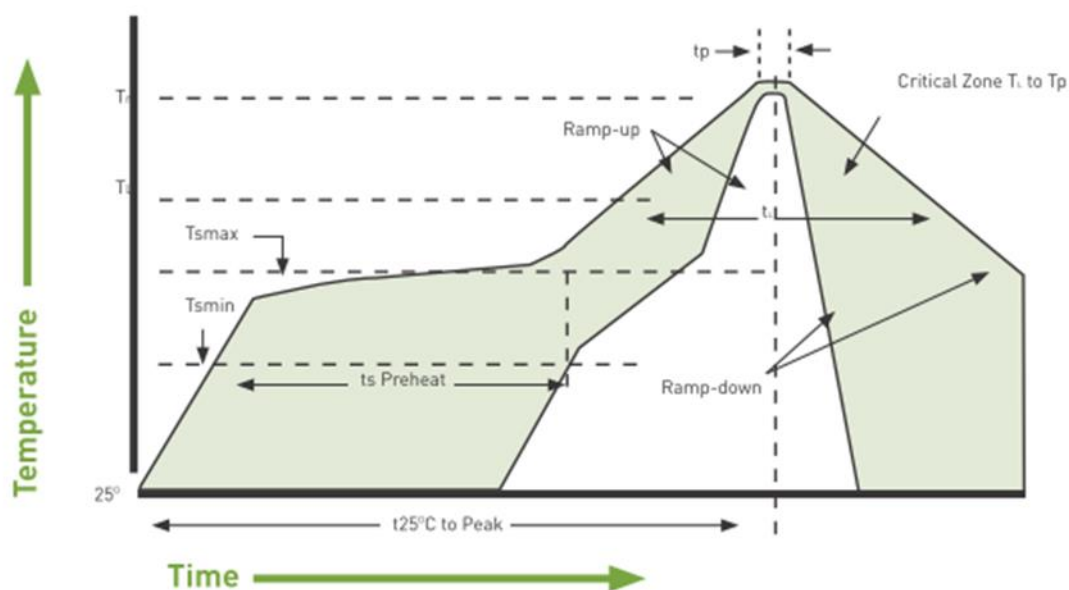

Changelog for the datasheet

**SPE-19-8-134 – PA.760.A**

**Revision: A (Original First Release)**

Date:	2019-10-18
Notes:	Initial Release
Author:	Jack Conroy

**Previous Revisions**



**TAOGLAS**®

[www.taoglas.com](http://www.taoglas.com)

