

## Specification

Part No.	:	<b>PA.26A</b>
Product Name	:	Anam LTE Ceramic SMT Antenna For 4G/3G/2G Applications 698MHz to 960MHz, 1710MHz to 2690MHz
Features	:	LTE / GSM / CDMA /DCS /PCS / WCDMA / UMTS / HSDPA / GPRS / EDGE /IMT, Compact High Efficiency Antenna Patent Pending Surface Mount Device Dims: 35*5*6mm <b>RoHS Compliant</b>



## 1. Introduction

The PA.26A is an SMT LTE 4G antenna designed for direct SMT mount on the device PCB. It provides highest efficiency in the smallest form SMT form factor, 35\*5\*6mm. Due to its rectangular shape and compact size the PA.26A is very easy to integrate and can be mounted directly on the edge of the PCB. Matching is accomplished using a pi network. Using SMT (On-Board) antennas saves on labor, cable, and connector costs. SMT antennas also lead to higher integration yield rates, higher transmit power and higher sensitivity.

The PA.26A operates at all common 4G/3G/2G LTE bands; 698MHz to 960MHz, 1710MHz to 2700MHz. The PA.26A also operates with great efficiency on worldwide Nb-IoT and CAT-M frequency bands.

Typical applications:

- Telematics Control Unit (TCU)
- HD Video over LTE
- First Responder and Emergency Services
- Intelligent Transport Systems
- Internet of Things (IoT)
- High Definition Video Broadcast Systems
- Wireless LTE M2M Devices
- Medical Devices

The antenna dimensions and footprint are exactly the same as the PA.25A, providing customers with a drop-in conversion from 2G/3G to 4G systems. Care should be taken to follow layout instructions and place antenna on the edge of board with adequate clearance to metal. Also minimum ground-plane requirements must be met to achieve targeted efficiencies. Taoglas provides optimization services for matching, and active TRP, TIS and RSE testing. Please contact your regional Taoglas sales office for support.

## 2. Specification Table

ELECTRICAL									
STANDARD	4G/3G/2G								
Operation Frequency (MHz)	LTE	GSM850	GSM900	DCS	PCS	UMTS1	LTE	LTE 2600	LTE 3500
	698-824	824-894	880-960	1710-1880	1850-1990	1920-2170	2300-2400	2500-2700	3400-3600
Peak Gain (dBi)	1.13	1.79	1.87	3.71	3.04	2.43	3.86	2.75	
Average Gain (dBi)	-4.34	-1.30	-1.45	-1.93	-2.99	-3.08	-1.95	-2.92	
Efficiency (%)	40.83	74.14	71.55	64.37	50.37	49.28	63.98	51.55	
VSWR	<3.5:1								
Impedance	50Ω								
Polarization	Linear								
Radiation Properties	Omnidirectional								
Max Input Power	5 W								

- The antenna was tested on a 110\*40mm ground plane and covered by 2mm thick ABS plastic.
- Actual Antenna Electrical performance will depend on customer ground plane size.

### MECHANICAL

Dimensions	35*5*6mm
Material	Ceramic
Termination	Ag (environmental-friendly Pb free)
Weight	3g
EVB Connector	SMA(F)

### ENVIRONMENTAL

Operation Temperature	-40°C to 85°C
Storage Temperature	-40°C to 105°C
Relative Humidity	Non-condensing 65°C 95% RH
RoHs Compliant	Yes

## 3. Test Configuration

### 3.1 Test Setup

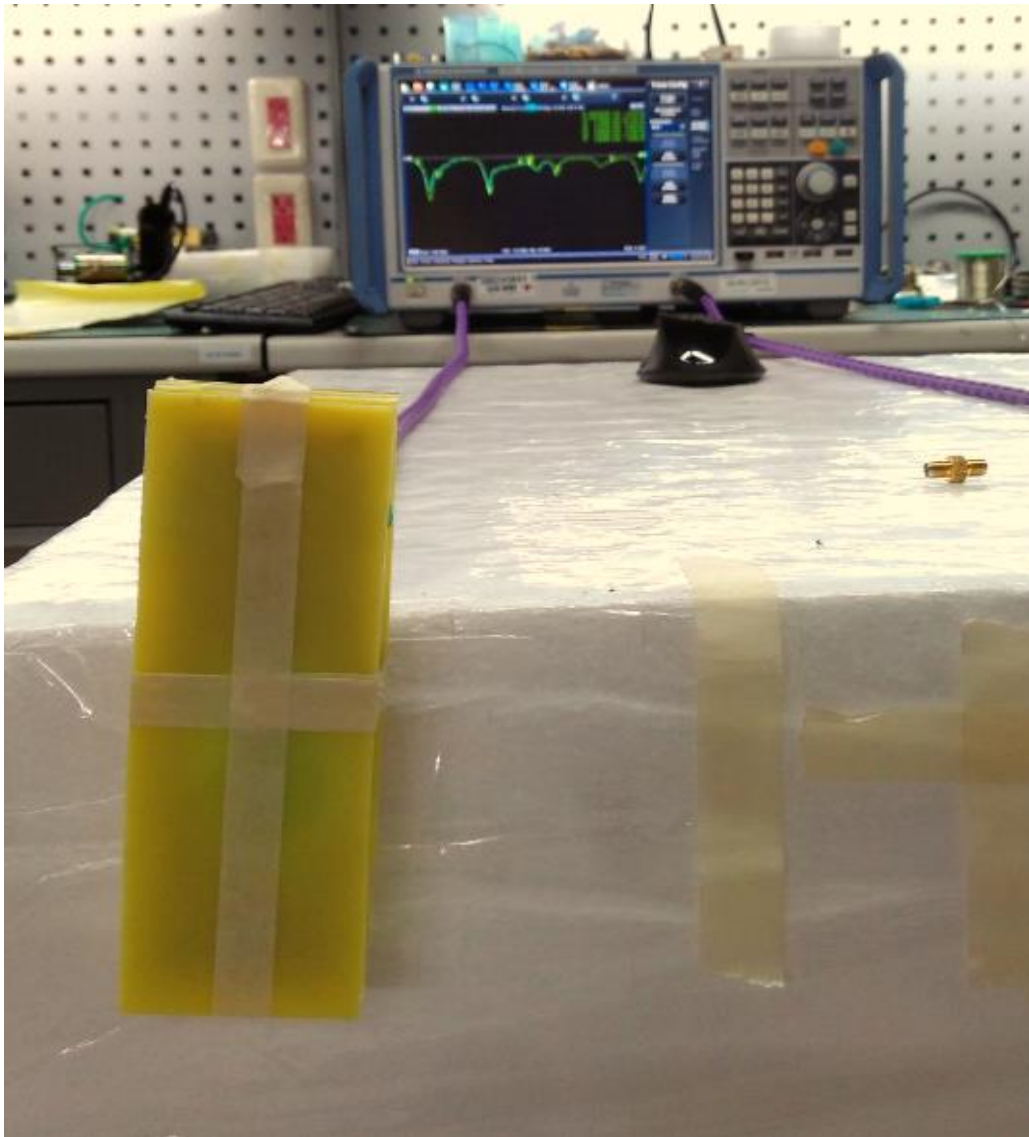

In free space



## 3.1.1 Return Loss

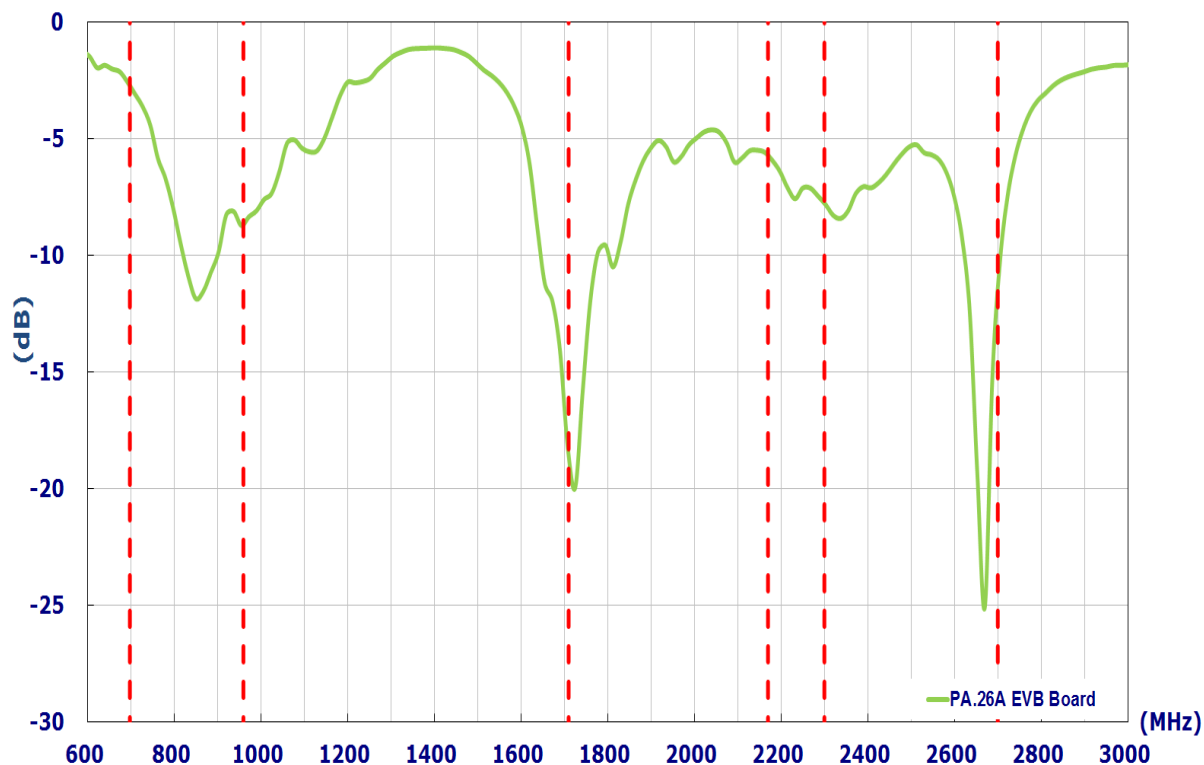

## 3.1.2 Efficiency

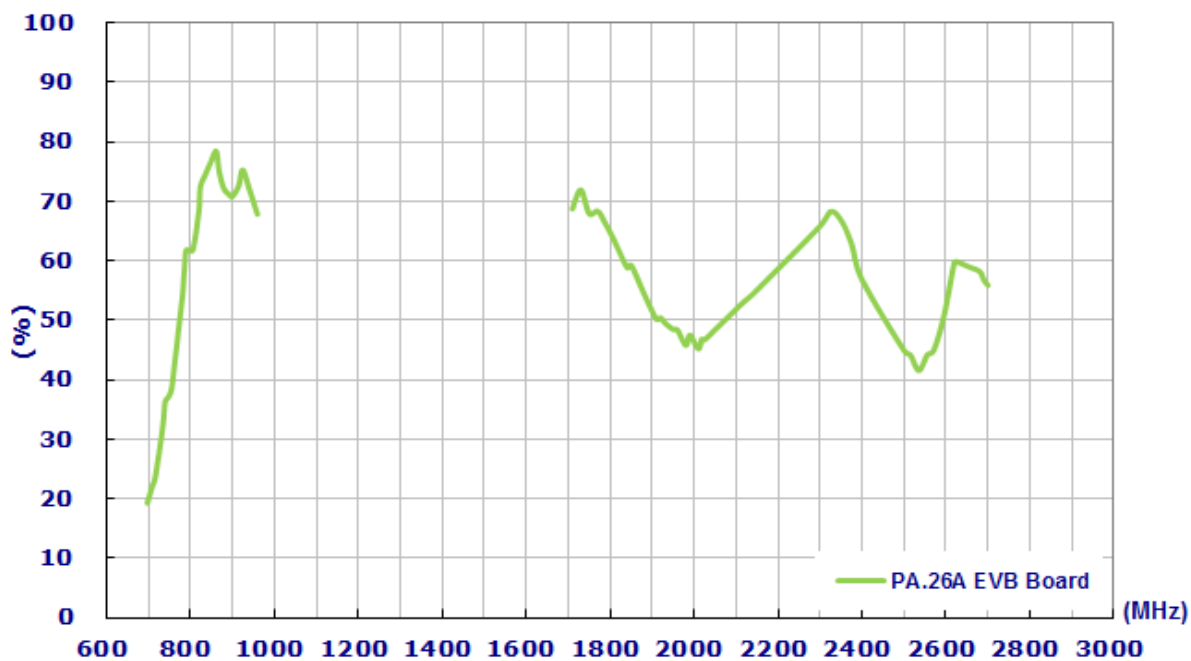



### 3.1.3 Peak Gain

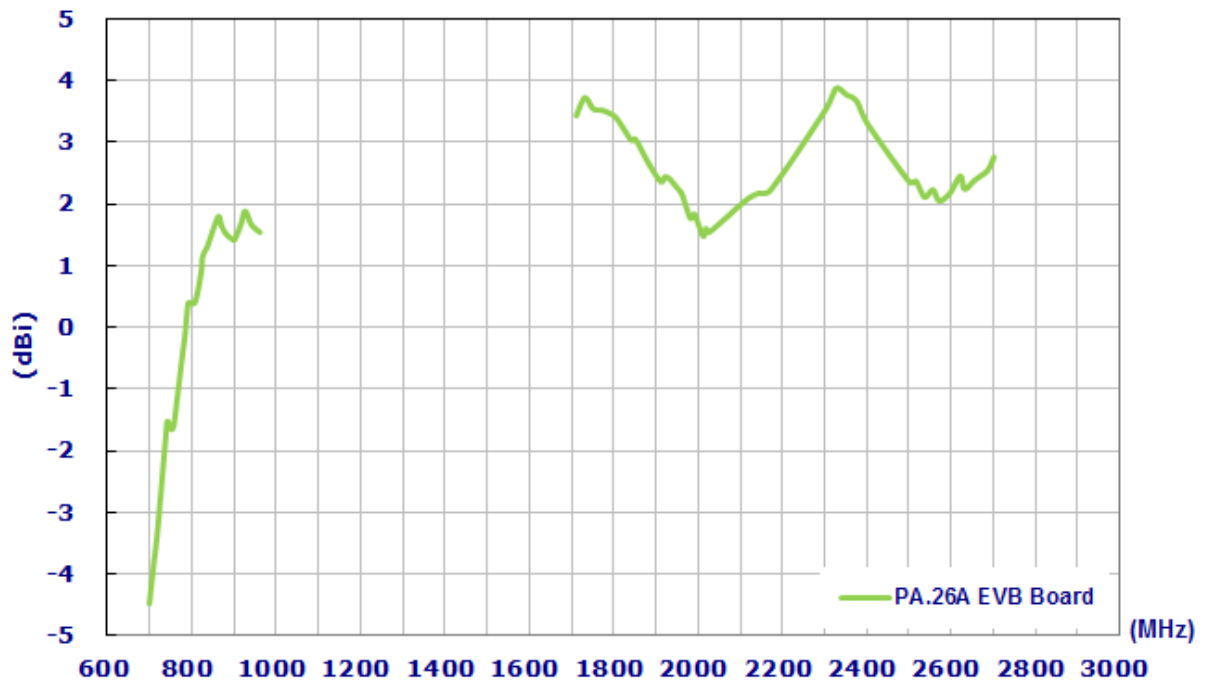

### 3.1.4 Average Gain

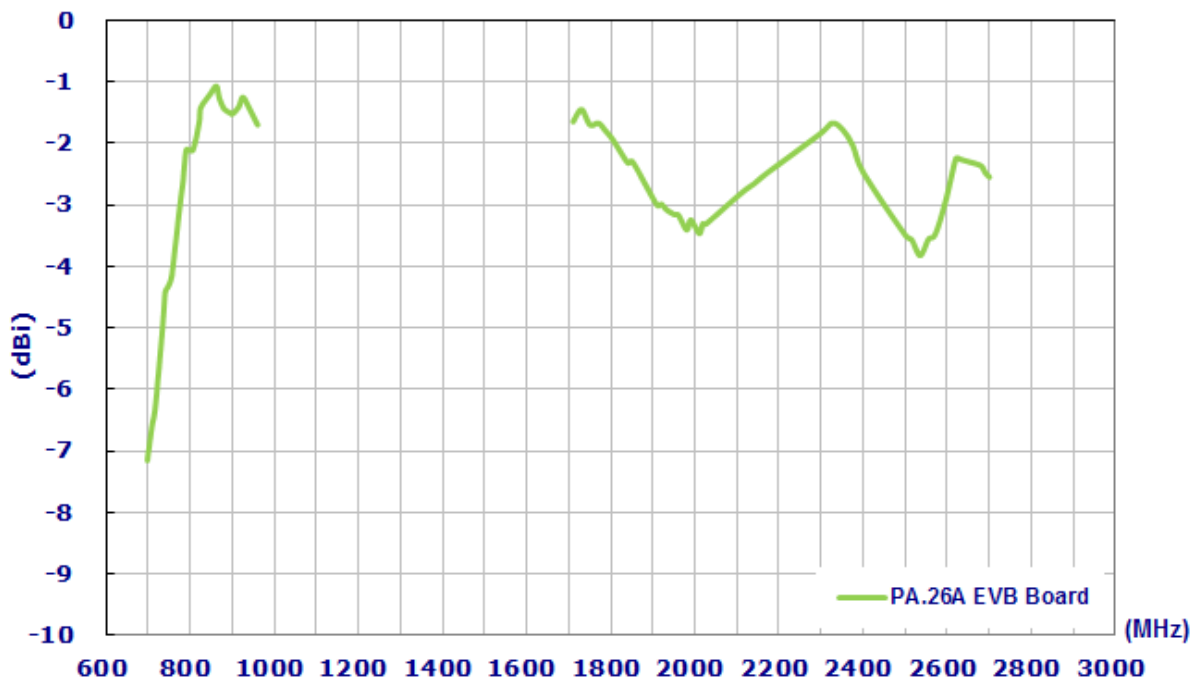

## 3.2 Radiation Pattern

### 3.2.1 Test Setup

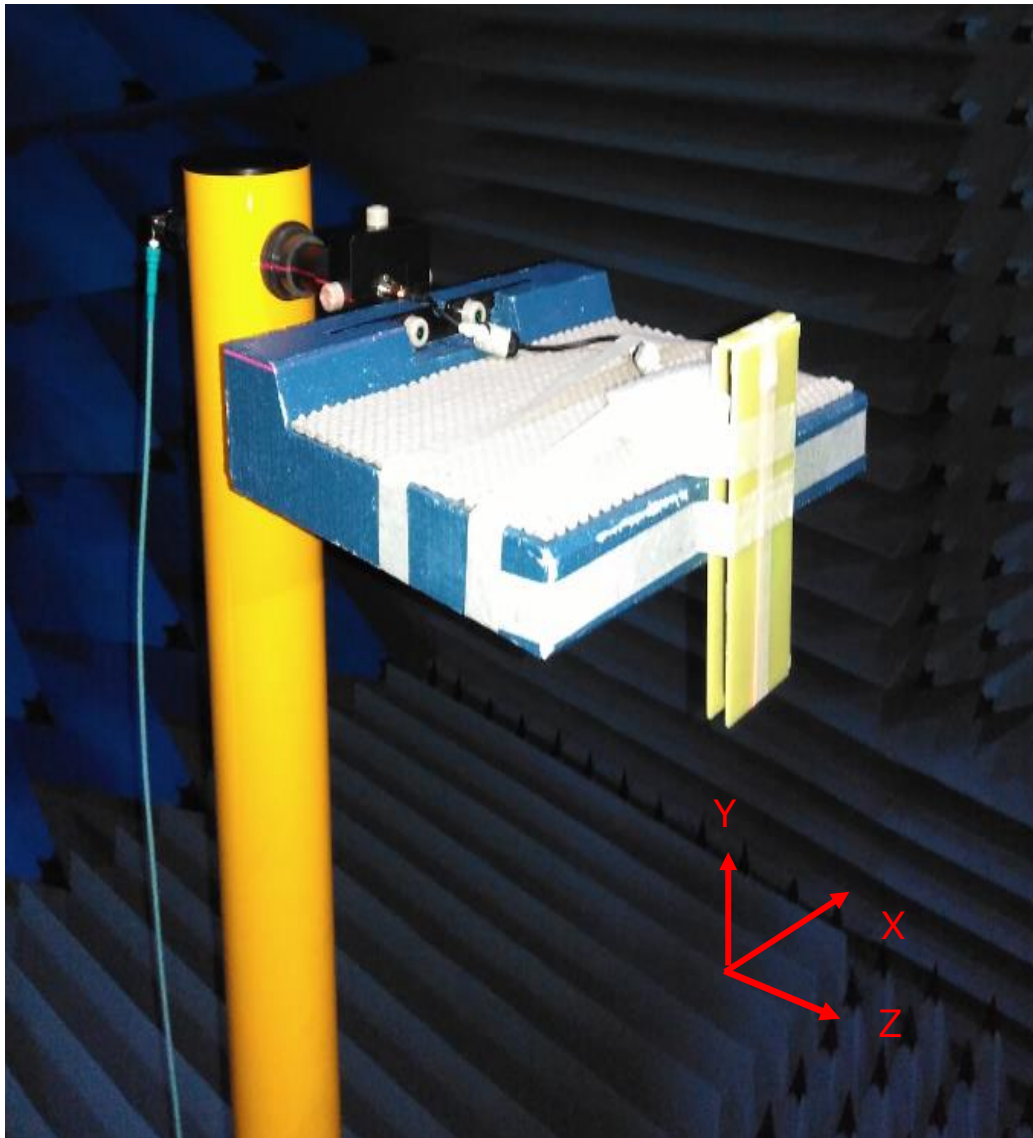

In free space





## 3.2.2.2 1710-2170MHz

XY Plane

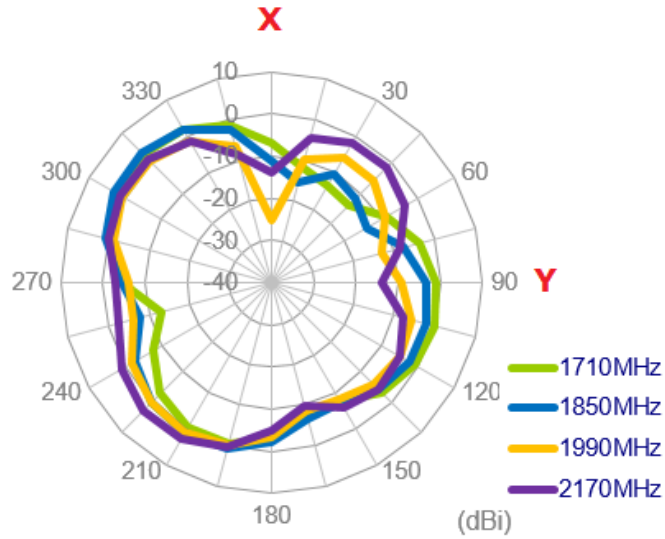

XZ Plane

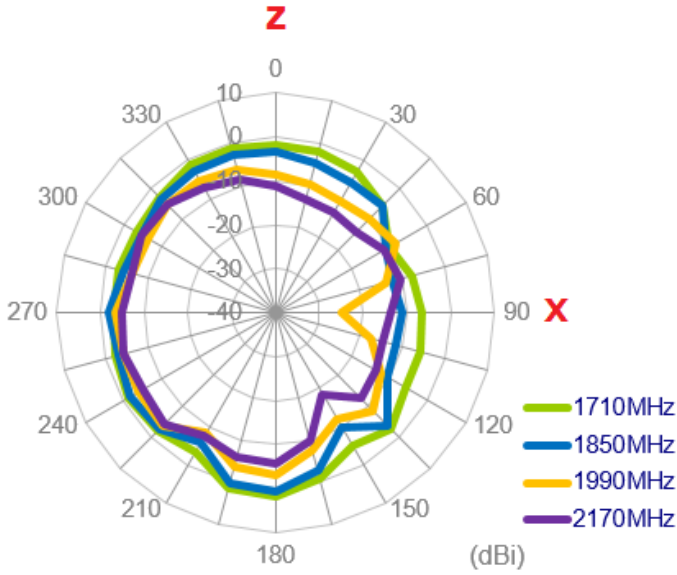

YZ Plane

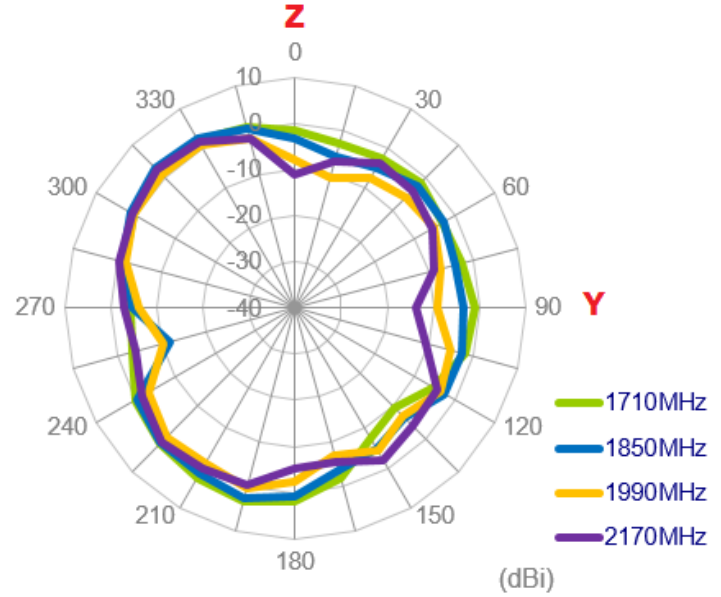

## 3.2.2.3 2500-2700MHz

XY Plane

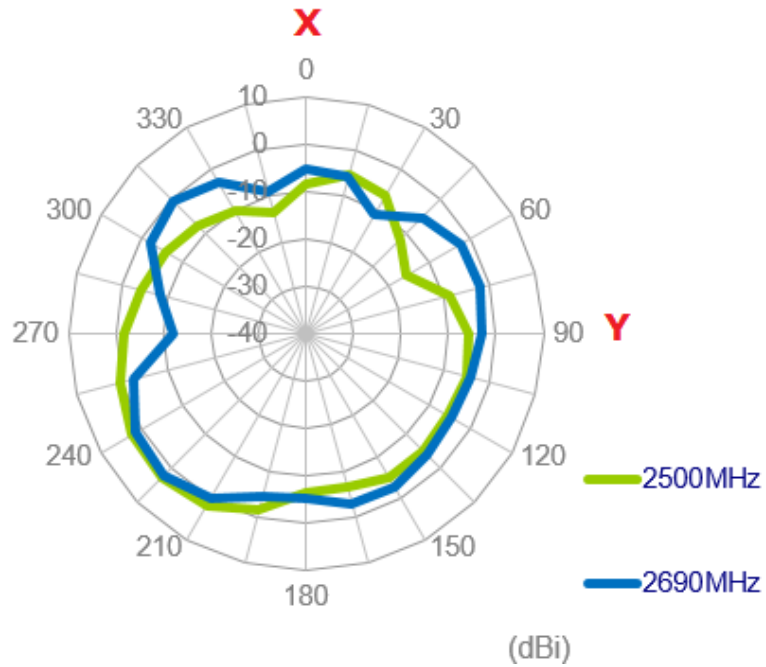

XZ Plane

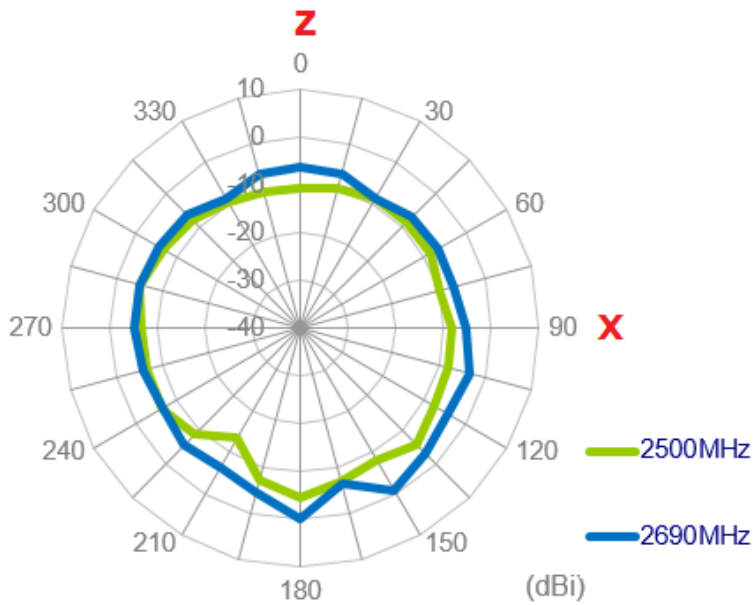

YZ Plane

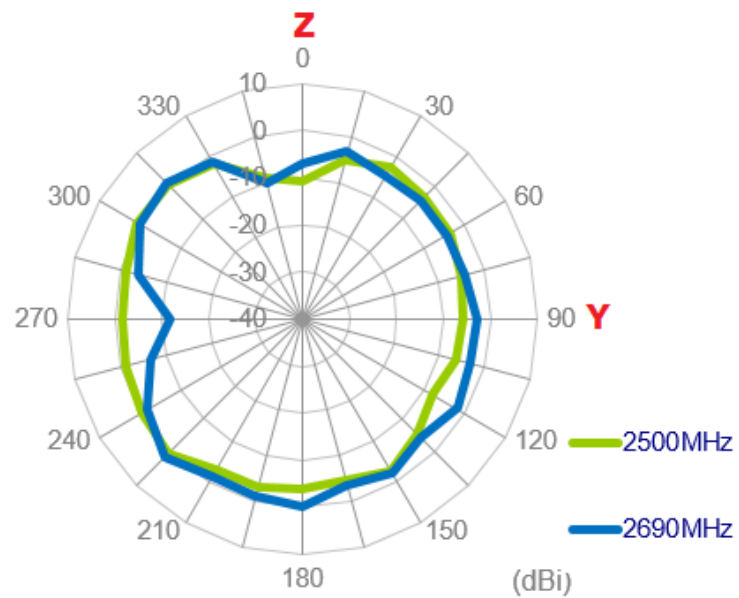



## 3.2.3 3D Radiation Pattern

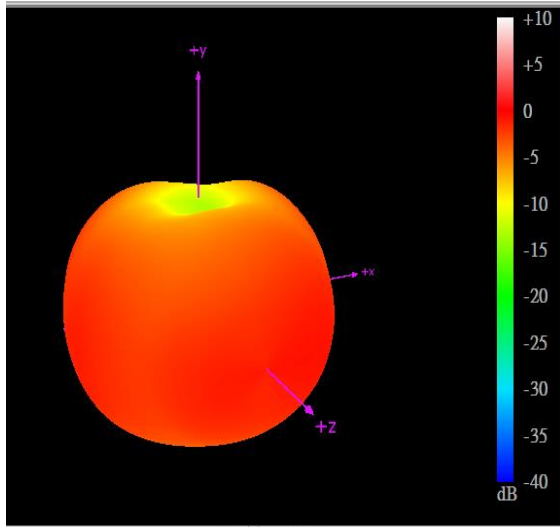

704MHz

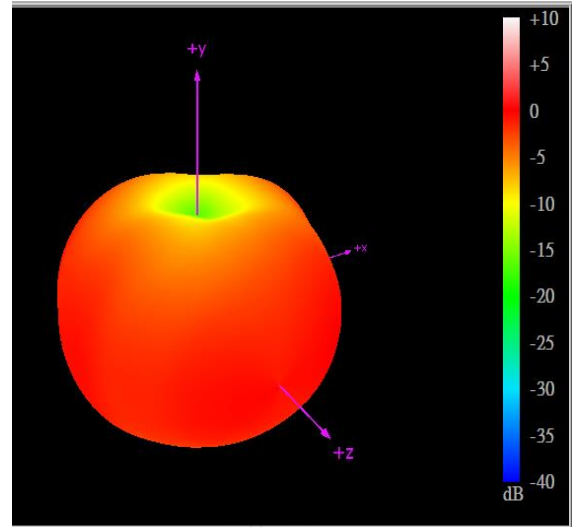

751MHz

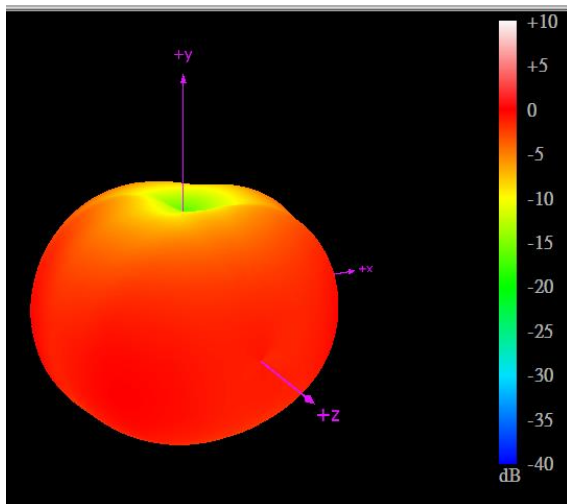

824MHz

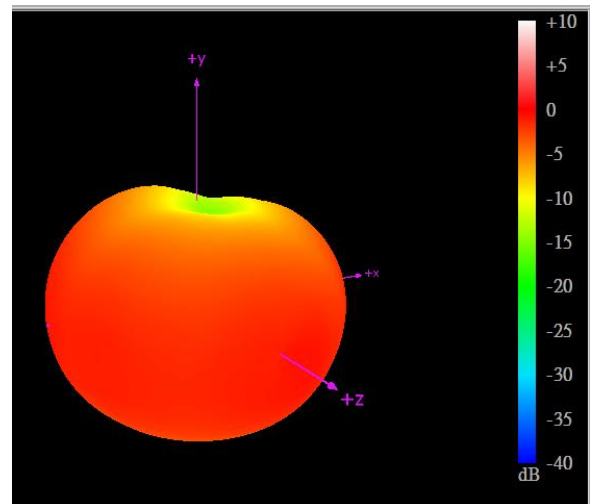

960MHz



# TAOGLAS®

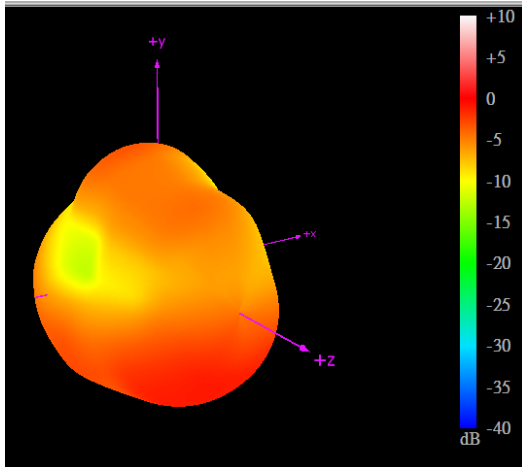

1710MHz

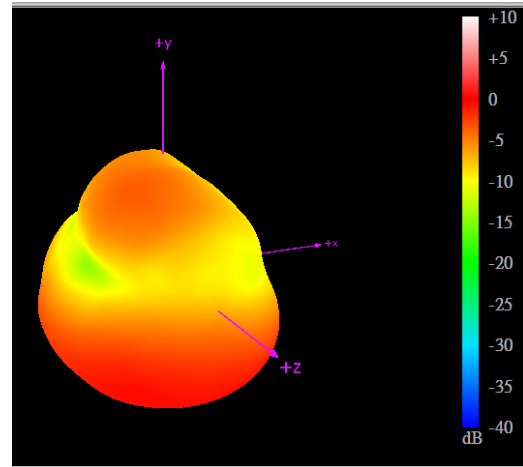

1850MHz

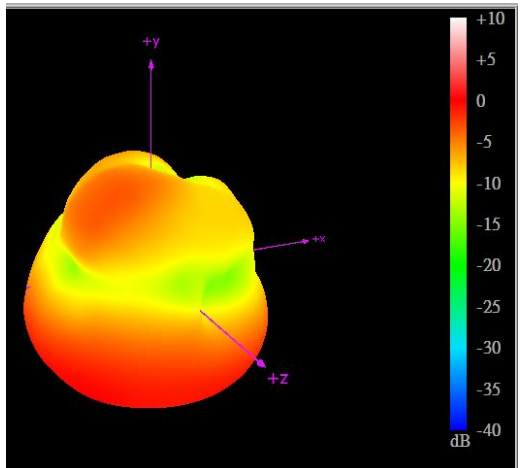

1990MHz

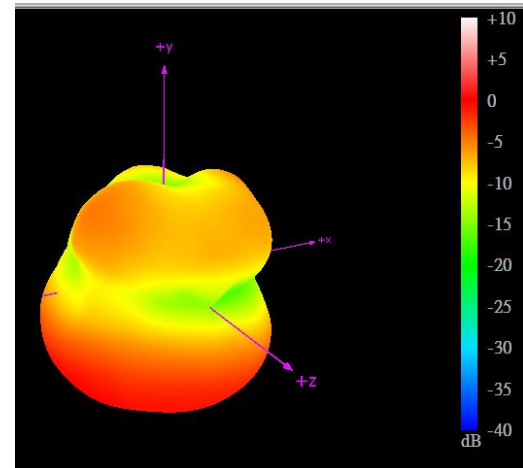

2170MHz

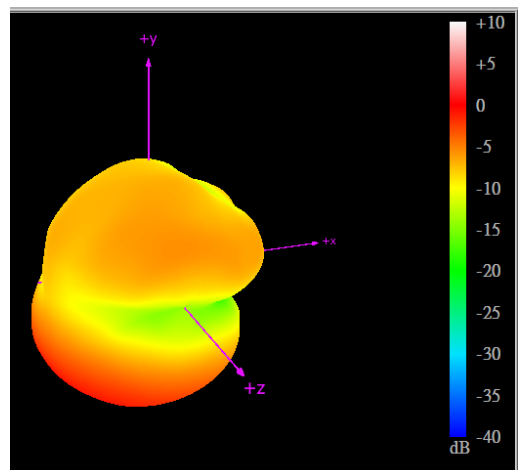

2500MHz

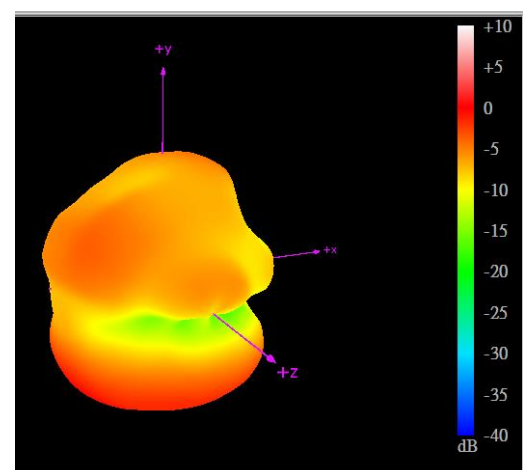

2690MHz

## 4. Drawings (Units: mm)

### 4.1. Antenna Dimensions

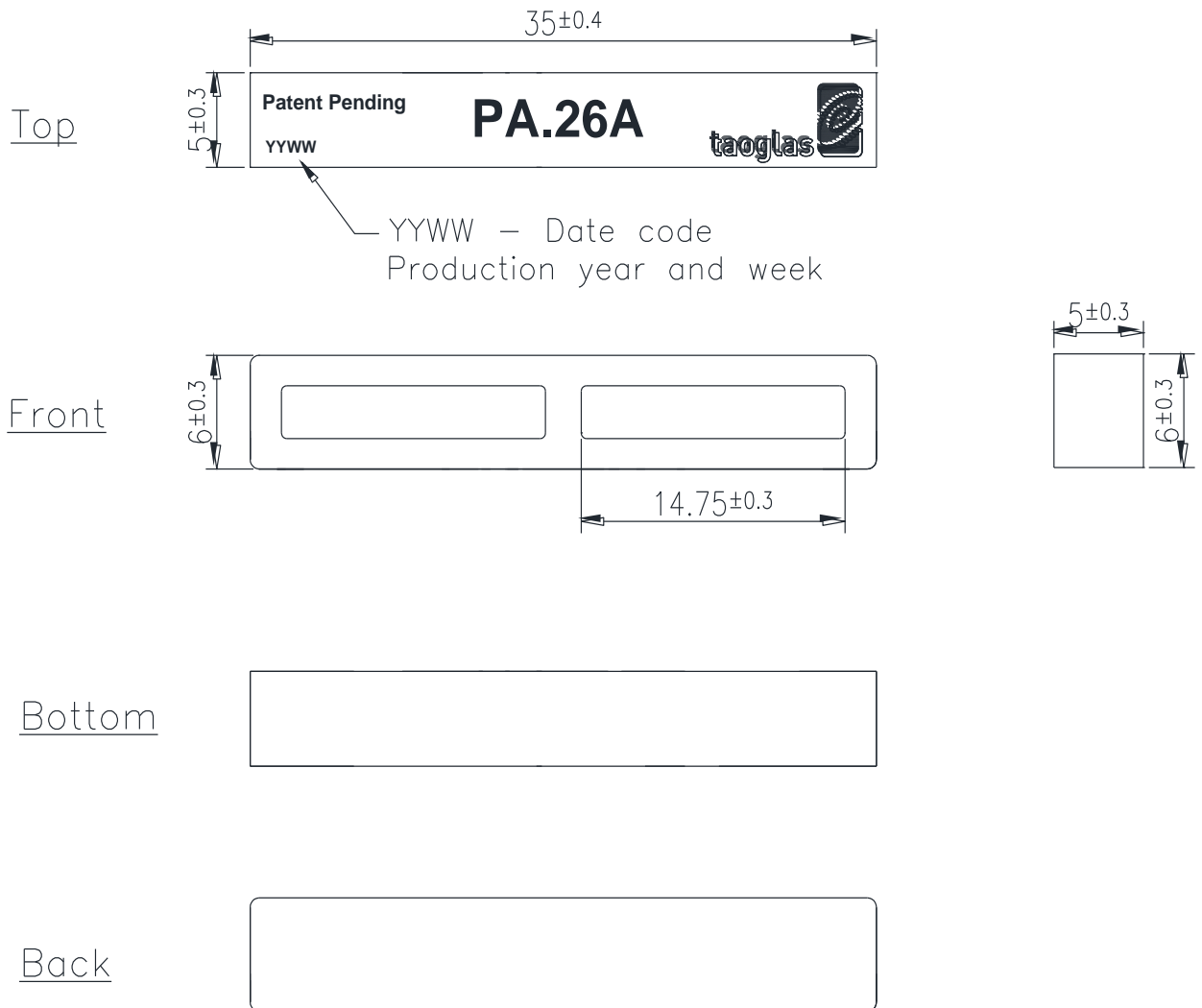

## 4.2. Antenna Footprint

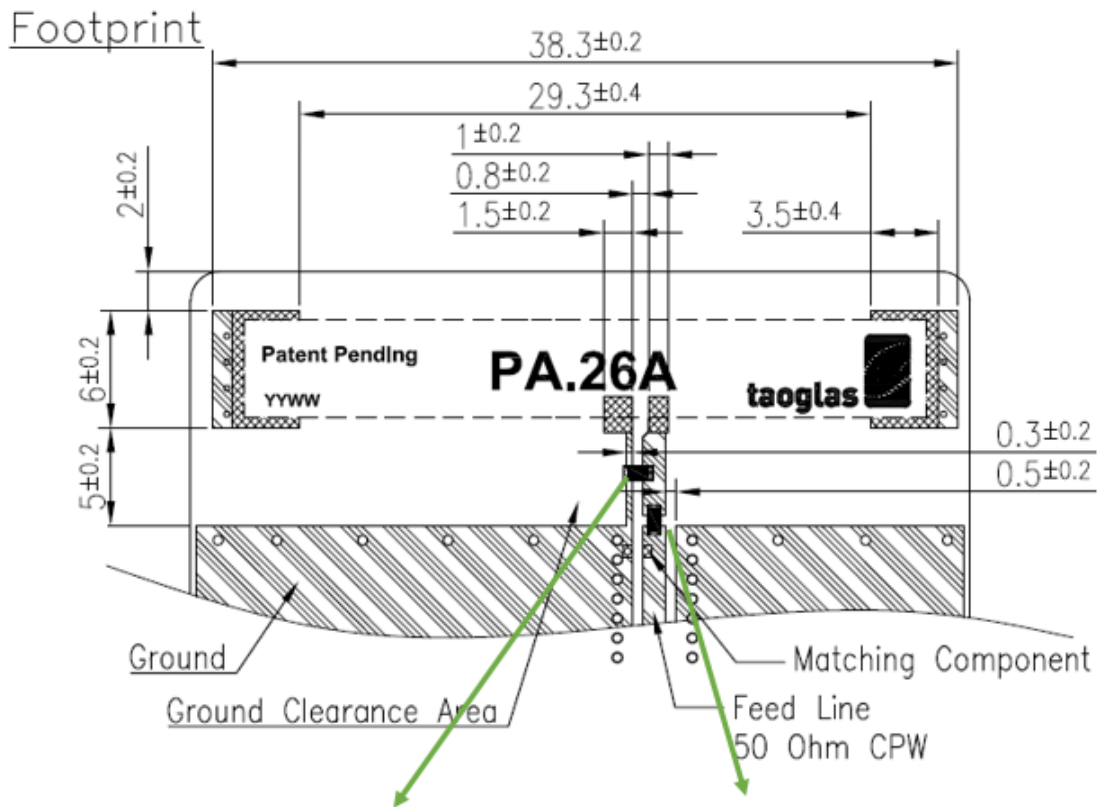

Note 1: Inductor Value 8.7nH for Taoglas Evaluation Board – different values may be required for different board designs

Note 2: Resistor Value 0Ω for Taoglas Evaluation Board – different values may be required for different board designs

	Size	Description
Note 1	0402	8.7nH Inductor
Note 2	0402	0Ω Resistor



# TAOGLAS®

## 5. EVB Drawing (Unit: mm)

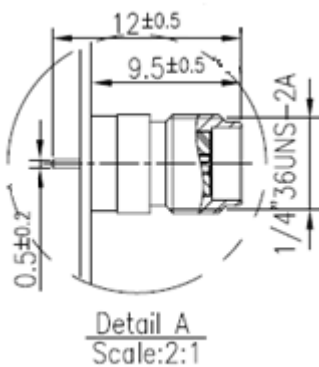
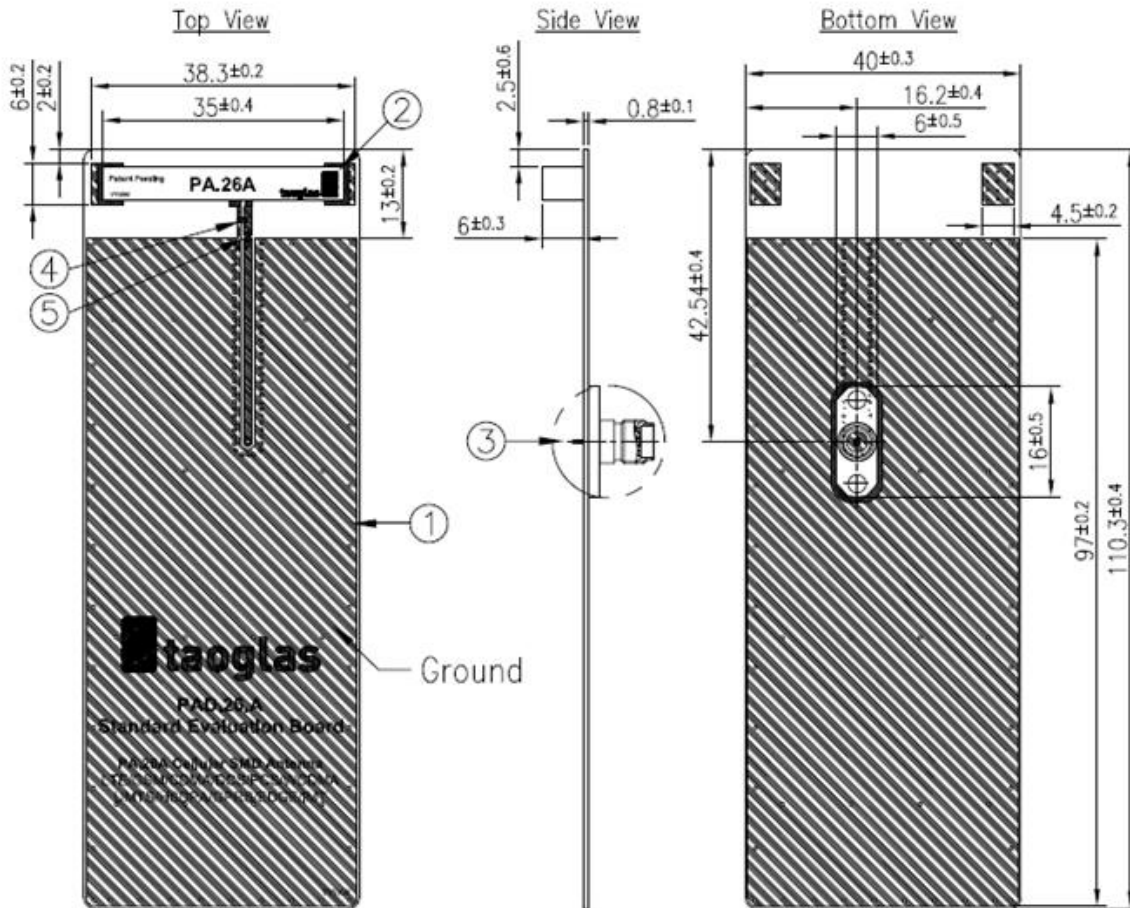

	Name	P/N	Material	Finish	QTY
1	PAD.26.A EVB PCB	100216A040000A	Composite	Black	1
2	PA.26A Antenna	001516A000000A	Ceramic	Clear	1
3	SMA(F) PCB	200216A00002BA	Brass	Au Plated	1
4	8.7nH Inductor (0402)	001516A010000A	Ceramic	Clear	1
5	0Ω Resistor (0402)	001511J010012A	Ceramic	Clear	1

## 6. Transmission Line & Matching Component

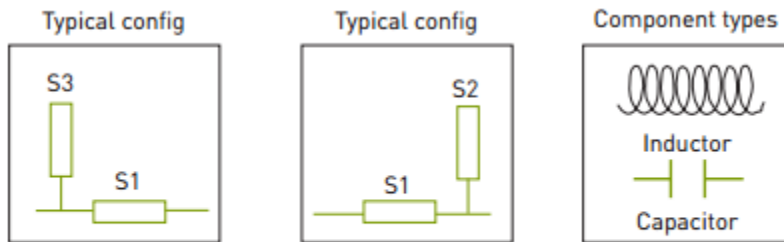
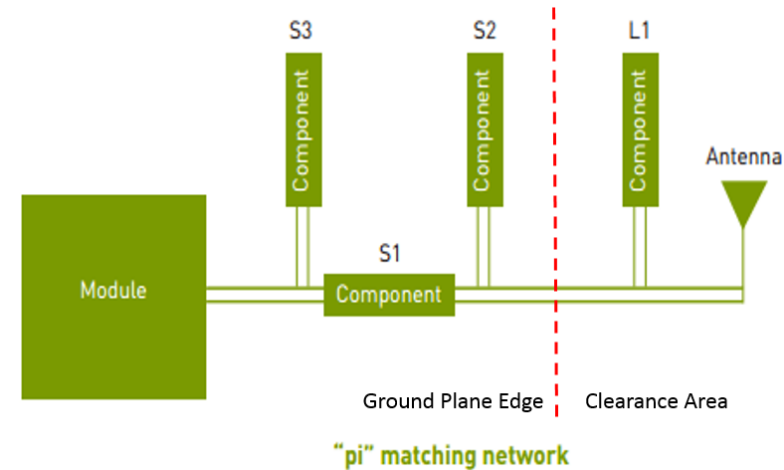

A matching component (L1 in the above drawing) in parallel with the PA.26A is required for the antenna to have optimal performance on the evaluation board, located outside of the ground plane in the space specified in the above drawings.

Additional matching components may be necessary for your device, so we recommend incorporating extra component footprints, forming a "pi" network, between the cellular module and the edge of the ground plane.





## 7. Recommended Reflow Temperature Profile

The PA.26 can be assembled following either Sn-Pb or Pb-Free assembly processes. The recommended soldering temperatures are as follows:

Phase	Profile Features	Sn-Pb Assembly	Pb-Free Assembly (SnAgCu)
Ramp-Up	Avg Ramp-Up Rate (T <sub>smax</sub> to T <sub>p</sub> )	3°C/second (max)	3°C/second (max)
Preheat	Temperature Min (T <sub>smin</sub> ) Temperature Max (T <sub>smax</sub> ) Time (t <sub>smin</sub> to t <sub>smax</sub> )	100°C 150°C 60-120 seconds	150°C 200°C 60-120 seconds
Reflow	Temperature (T <sub>L</sub> ) Total Time Above T <sub>L</sub> b[t <sub>L</sub> ]	183°C 60-150 seconds	217°C 60-150 seconds
Peak	Temperature (T <sub>p</sub> ) Time (t <sub>p</sub> )	235°C 10-30 seconds	260°C 20-40 seconds
Ramp-Down	Rate	6°C/second (max)	6°C/second (max)
Time from 25°C to peak Temperature		6 minutes max	8 minutes max

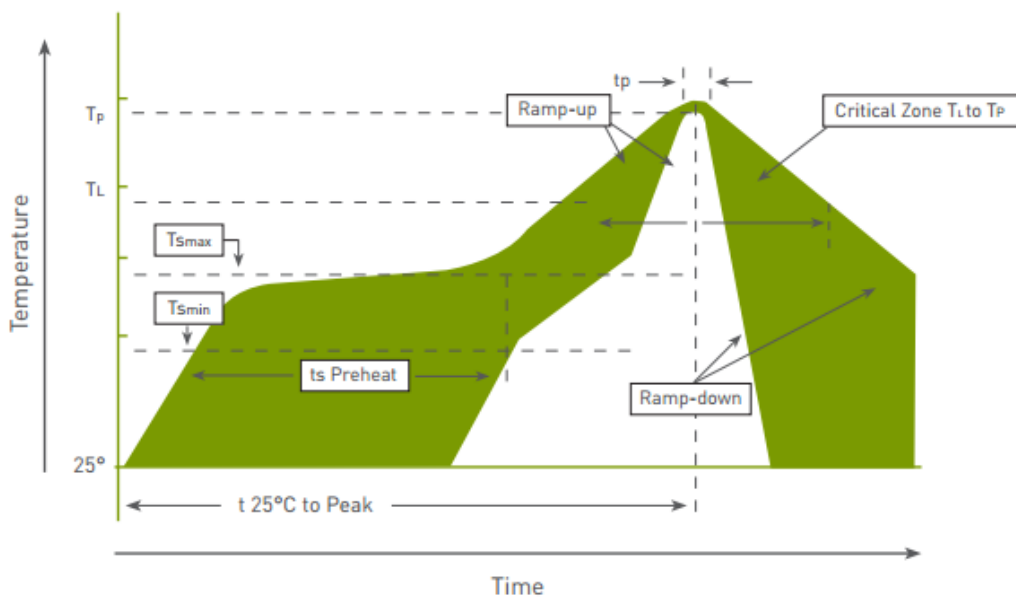

Temperature profile – (green area) for the assembly process in reflow ovens



## 8. Packaging Specifications (Units: mm)

450 pc PA.26A  
 1 reel per small inner box  
 Dimensions - 330\*56mm  
 Weight - 1.7kg

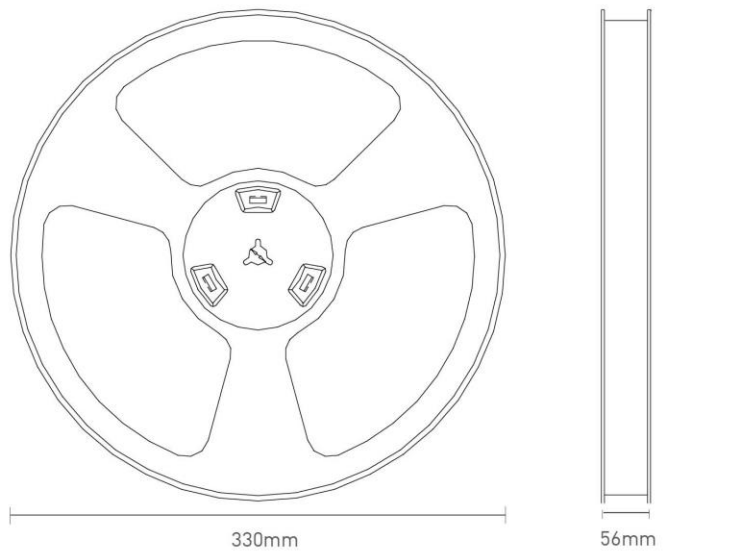

Symbol	Spec
Po	4.0 ± 0.10
P1	12.0 ± 0.10
P2	2.0 ± 0.15
Do	1.5
D1	2.0 (Min)
F	20.2 ± 0.10
So	40.4 ± 0.10
W	44.0 ± 0.30

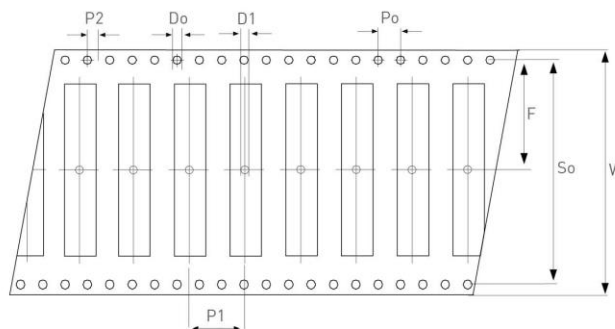



# TAOGLAS®

450 pc PA.26A  
1 reel in small inner box  
Dimensions - 350\*340\*67  
Weight - 1.9Kg

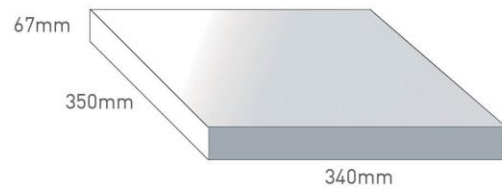

3 boxes / 1350 pcs in one carton  
Carton Dimensions - 370\*360\*275mm  
Weight - 6.8Kg

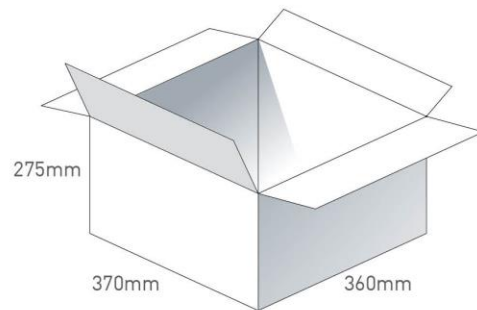

Pallet Dimensions 1110\*720\*1270mm  
24 Cartons per Pallet  
6 Cartons per layer  
4 Layers

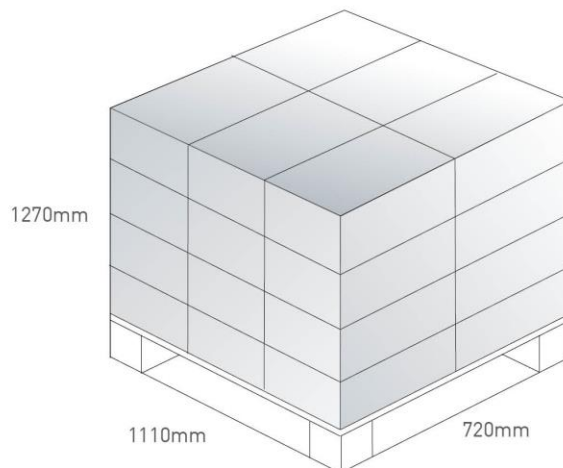

## 9. Application Note

Taoglas PA.26A antenna performance with different ground plane lengths.

### 9.1 Return Loss

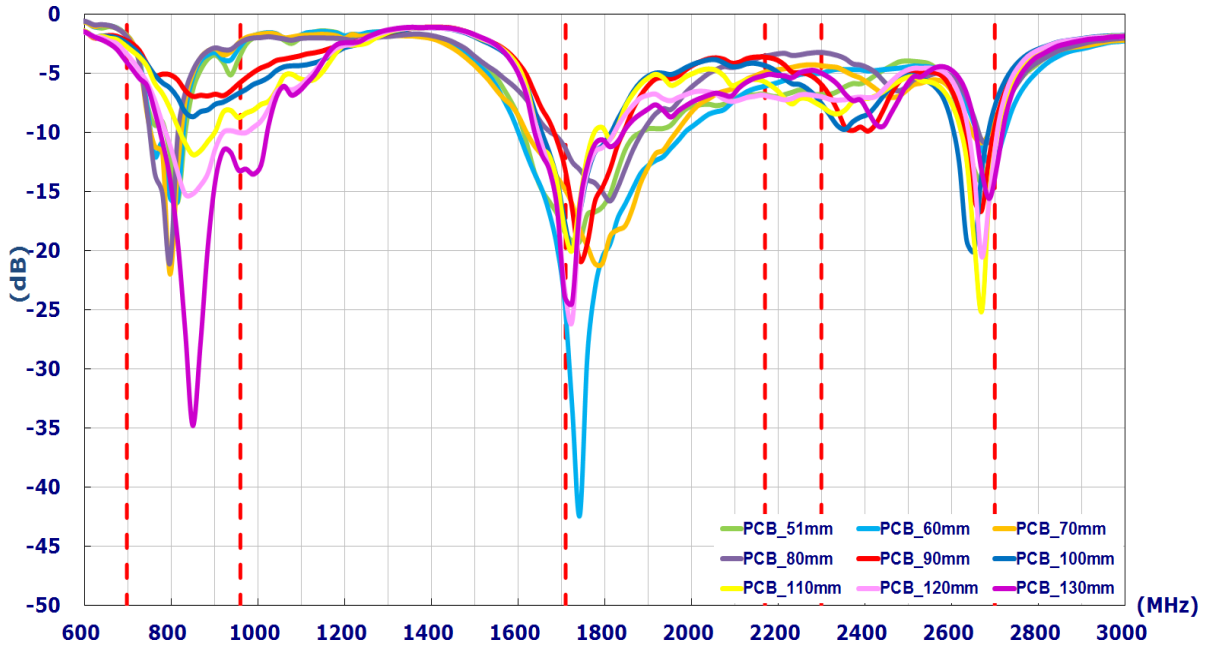

### 9.2 Efficiency

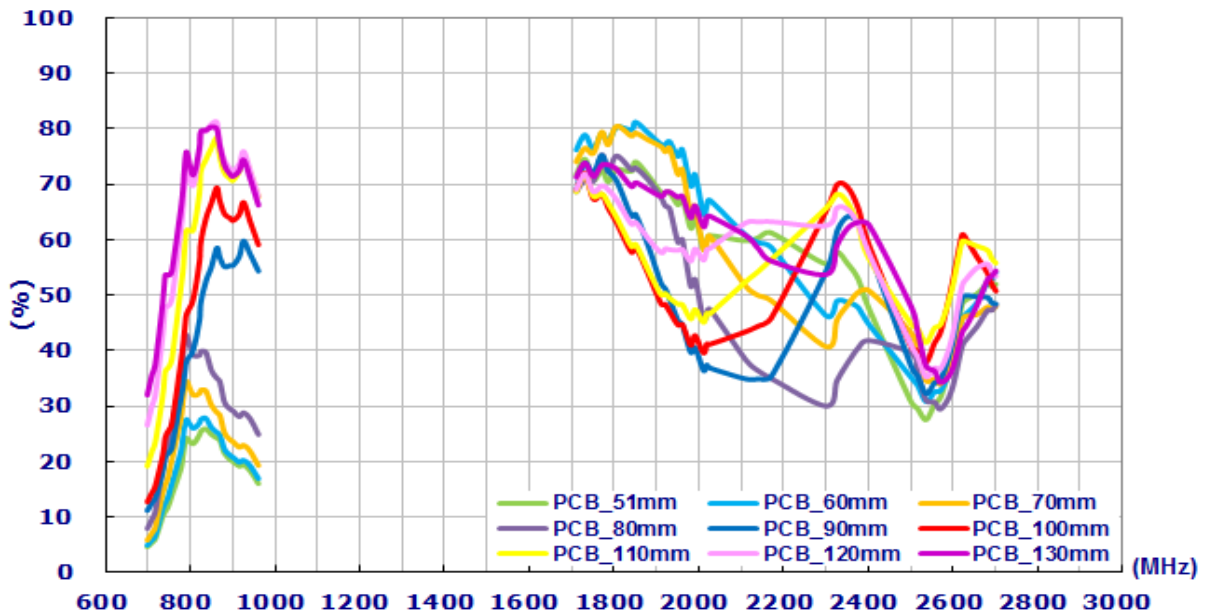



## 9.3 Peak Gain

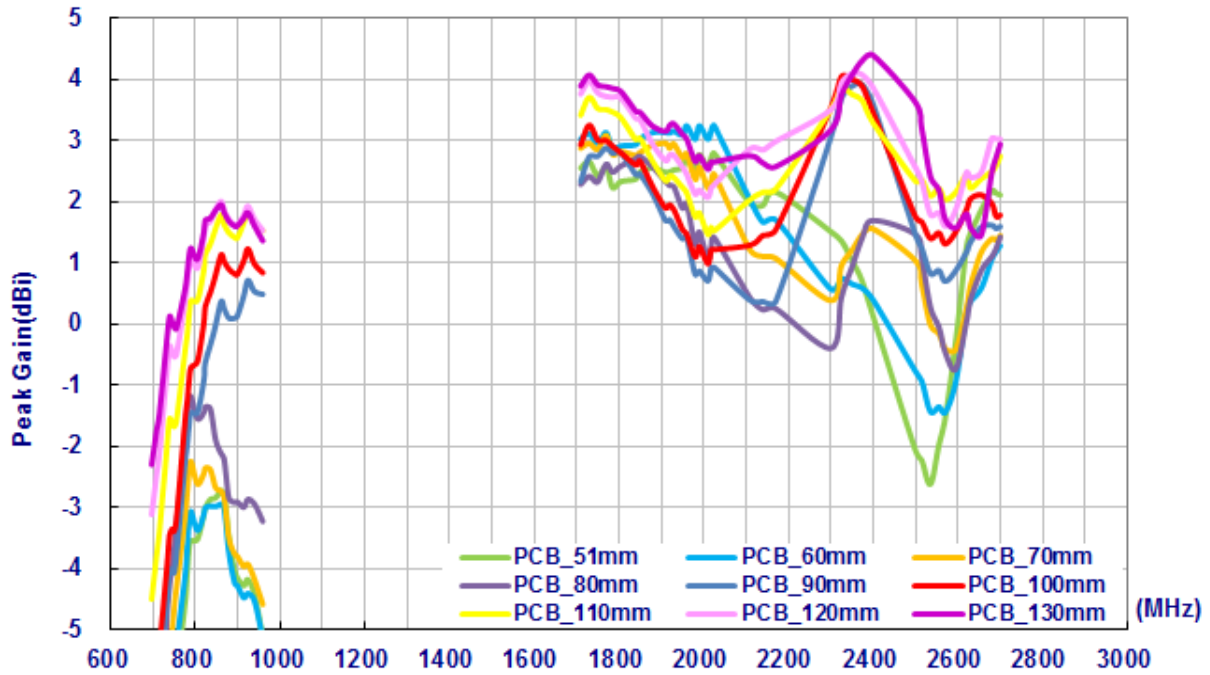

## 9.4 Average Gain

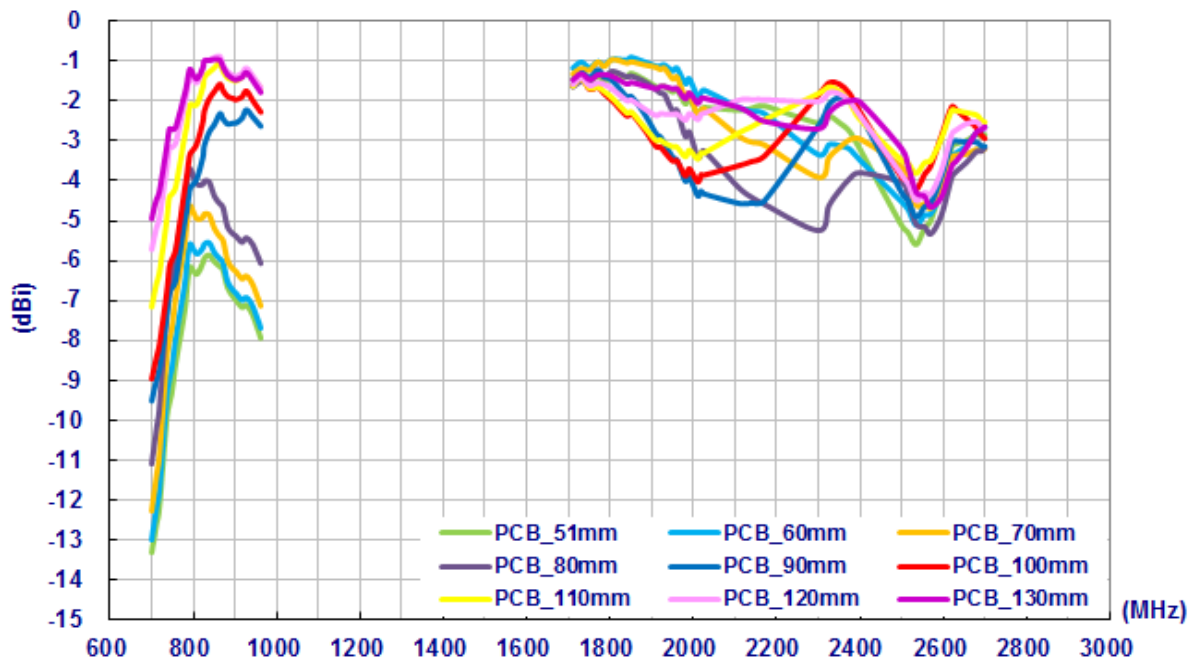



Taoglas makes no warranties based on the accuracy or completeness of the contents of this document and reserves the right to make changes to specifications and product descriptions at any time without notice. Taoglas reserves all rights to this document and the information contained herein.

Reproduction, use or disclosure to third parties without express permission is strictly prohibited.

Copyright © Taoglas Ltd.