

# SPECIFICATION

## Patent Pending

- Part No. : **MA910.W.A.CG.001**
- Product Name : **Guardian** 2 in 1 Wi-Fi MIMO  
Adhesive Mount Antenna
- Features : Low-Profile Housing – Mounts Flush to Wall  
2\* Wi-Fi MIMO 2.4GHz/5.8 GHz  
IP67 Waterproof Resistant Enclosure  
Dims: 146\*134\*20mm  
Cable: 3000mm Low Loss KSR200-P with RP-SMA(M)  
connectors  
Custom Cables and Connectors Available  
**RoHS Compliant**



## 1. Introduction

The MA910 Guardian is a low-profile 2 in 1 Wi-Fi MIMO wall and adhesive mount external antenna. As part of the first series of panel antenna worldwide designed for IoT gateway and router devices, it belongs to a new generation of combination antenna.

The MA910 Guardian is ideal for Wi-Fi applications requiring the increased data throughput and range provided by MIMO technology, all in a convenient and compact form factor. It is designed with high efficiency and gain as well as high isolation between the antennas to prevent self-interference. Low loss cables are used to keep efficiency high over long cable lengths. With its heavy-duty, fully IP67 casing, the MA910 Guardian can withstand a range of environments.

All of these factors make the MA910 Guardian antenna an excellent choice for use by RF professionals in:

- IoT Gateway and Routers
- HD Video Streaming
- Transportation
- Remote monitoring applications

The standard MA910 Guardian antenna comes with 3 meter, low loss KSR-200-P coaxial cable. Customized cables and connector versions are also available. Also available in black.

## 2. Specification

2.4GHz/5GHz Wi-Fi Antenna			
Frequency (MHz)		2400~2500	4900~5850
Efficiency (%)			
MIMO_1	Free space	43.80	31.63
	ABS	40.64	32.52
	Glass	40.95	31.05
	Metal	39.31	30.75
	Wall	46.28	30.47
MIMO_2	Free space	33.44	30.94
	ABS	35.14	30.79
	Glass	30.94	30.85
	Metal	34.58	30.00
	Wall	38.41	28.68
Average Gain (dBi)			
MIMO_1	Free space	-3.59	-5.08
	ABS	-3.91	-4.96
	Glass	-3.88	-5.18
	Metal	-4.06	-5.26
	Wall	-3.35	-5.25
MIMO_2	Free space	-4.77	-5.15
	ABS	-4.57	-5.18
	Glass	-5.11	-5.17
	Metal	-4.65	-5.34
	Wall	-4.16	-5.49
Peak Gain (dBi)			
MIMO_1	Free space	3.15	3.14
	ABS	4.14	3.38
	Glass	1.79	3.23
	Metal	4.02	4.18
	Wall	4.27	3.97
MIMO_2	Free space	1.74	3.90
	ABS	0.98	3.63
	Glass	2.55	5.27
	Metal	4.82	4.96
	Wall	2.03	4.17
Impedance	50Ω		
Polarization	Linear		
VSWR	< 3		
Cable	3 meter KSR200-P standard, fully customizable		
Connector	RP-SMA(M) standard, fully customizable		

MECHANICAL	
Antenna Dimensions	146*134*20mm
Casing	ASA
Weight (including cable)	672g
Ingress Protection Rating	IP67
ENVIRONMENTAL	
Operation Temperature	-40°C to 85°C
Storage Temperature	-40°C to 90°C
Humidity	Non-condensing 65°C 95% RH

### 3. Antenna Characteristics

#### 3.1 Wi-Fi MIMO Antenna

##### 3.1.1 Test Setup

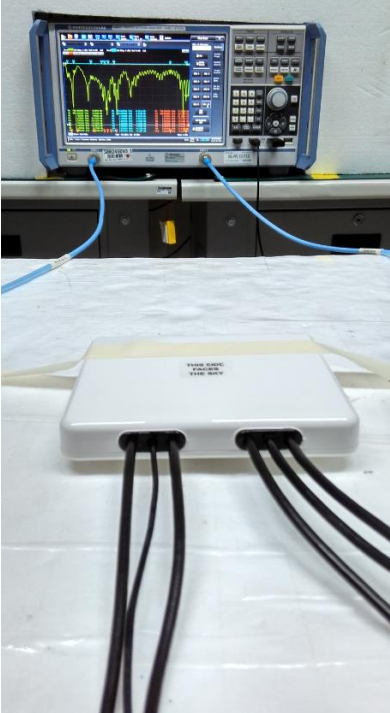

Free space



ABS

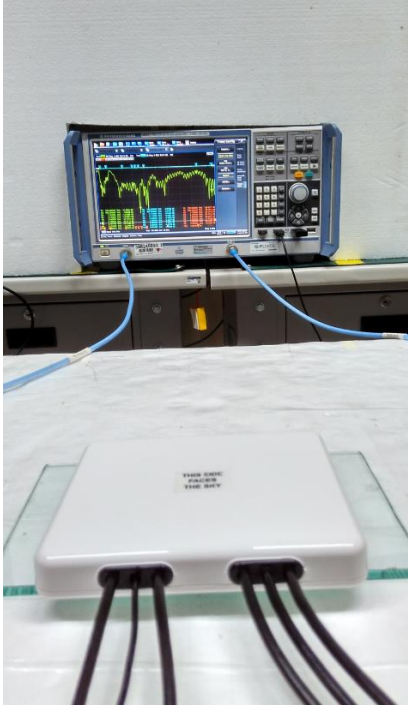

Glass

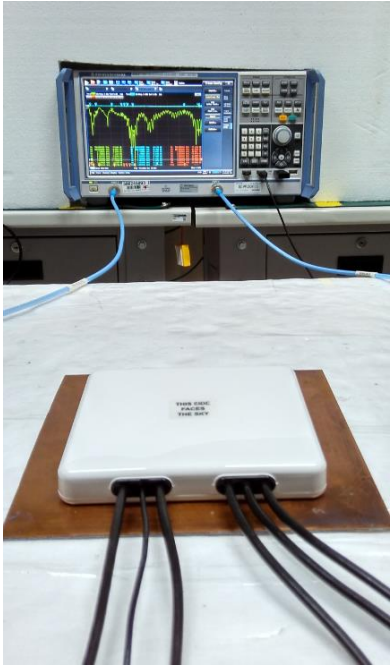

Metal



Wall

### 3.1.2 Wi-Fi 1 Antenna Return Loss

Performance in different environments with 3 meter cable length

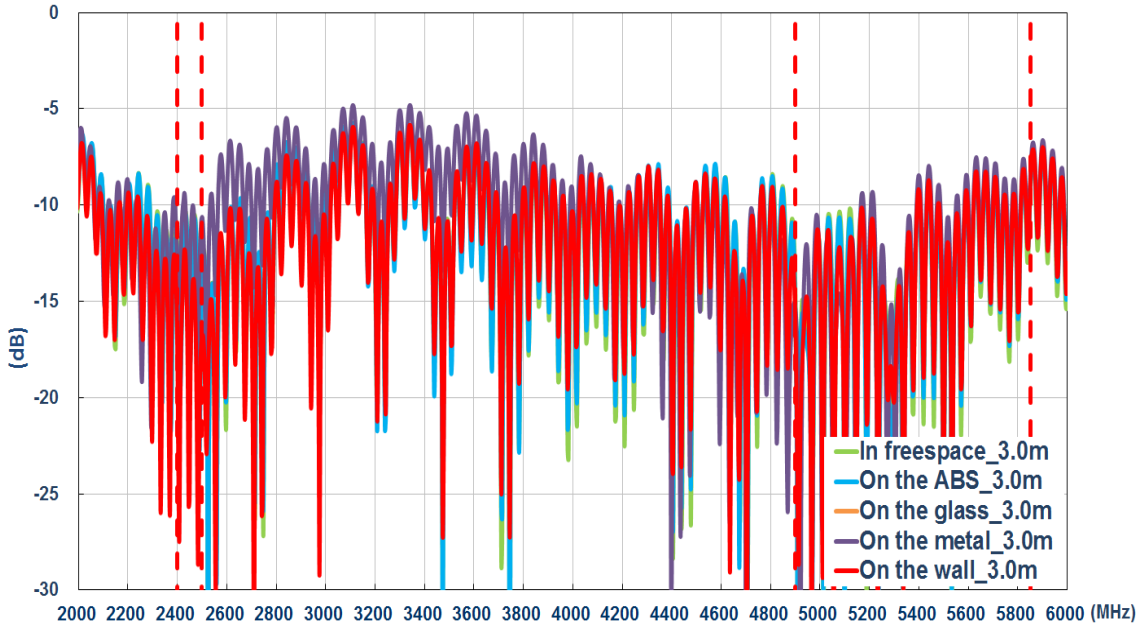

### 3.1.3 Wi-Fi 2 Antenna Return Loss

Performance in different environments with 3 meter cable length

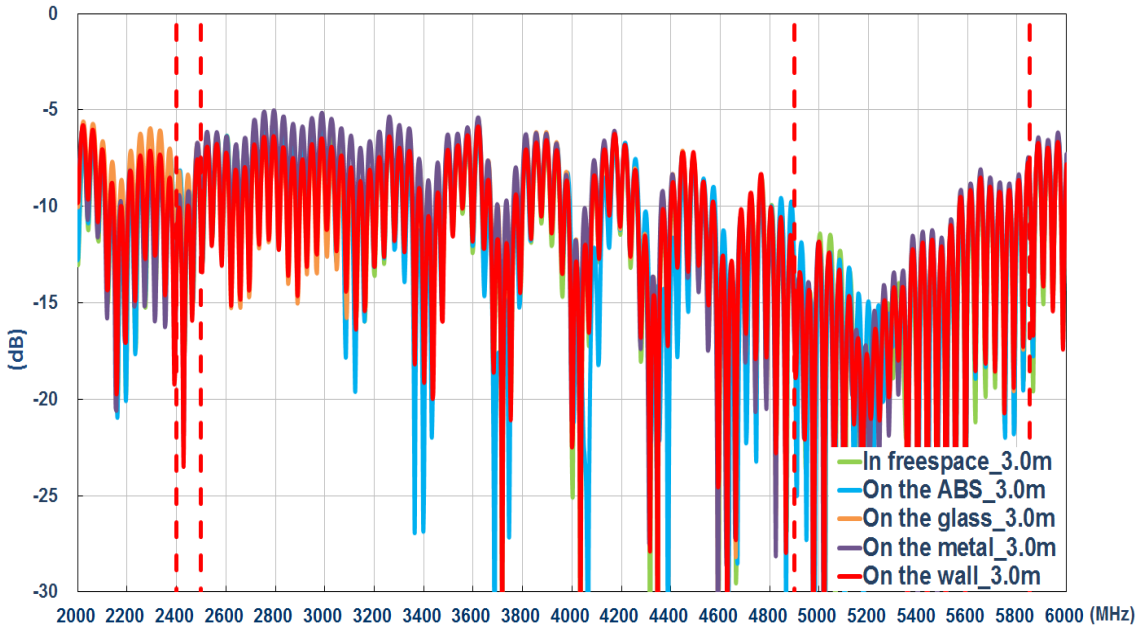

3.1.4 Wi-Fi Envelope Correlation Coefficient  
Performance in different environments with 3 meter cable length

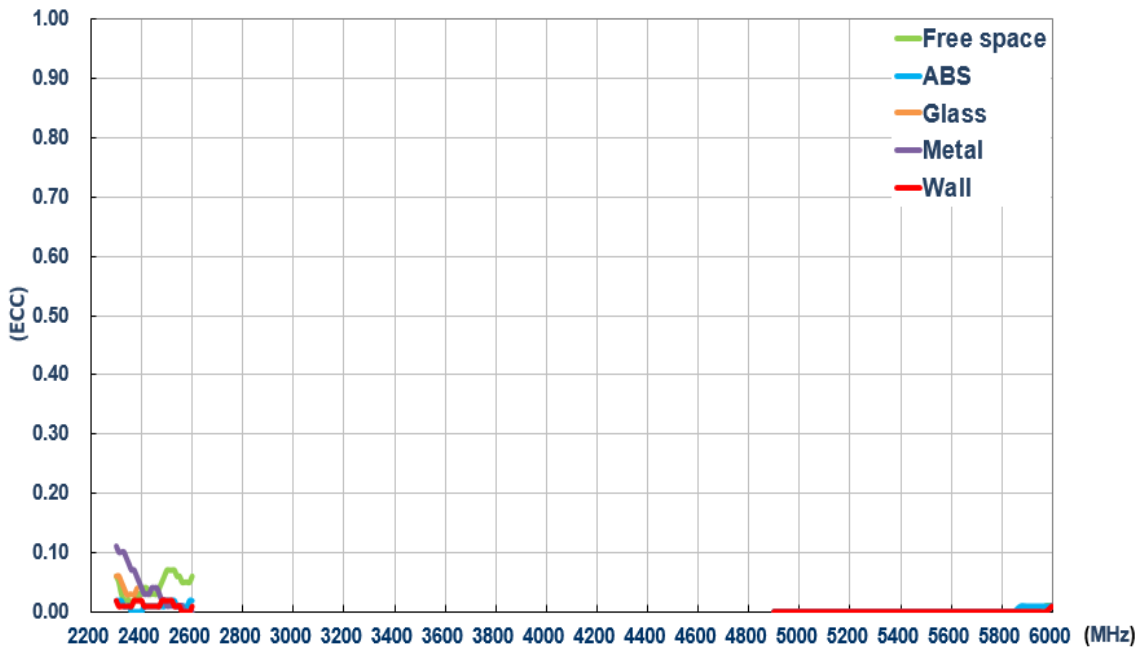

3.1.5 Wi-Fi 1 Antenna Efficiency  
Performance in different environments with 3 meter cable length

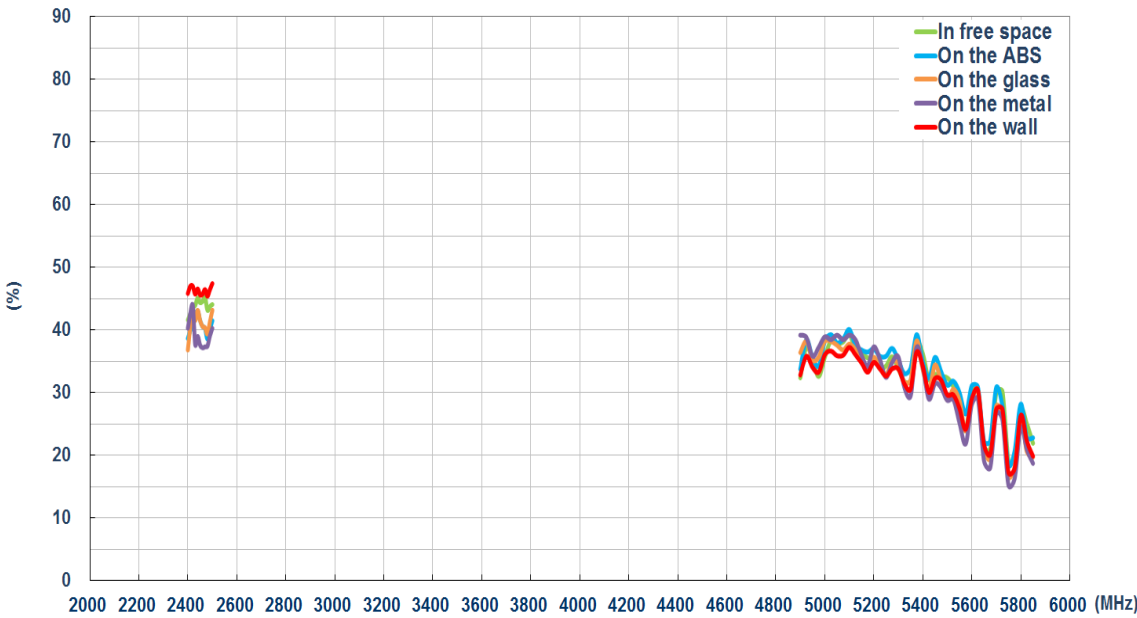

### 3.1.6 Wi-Fi 2 Antenna Efficiency

Performance in different environments with 3 meter cable length

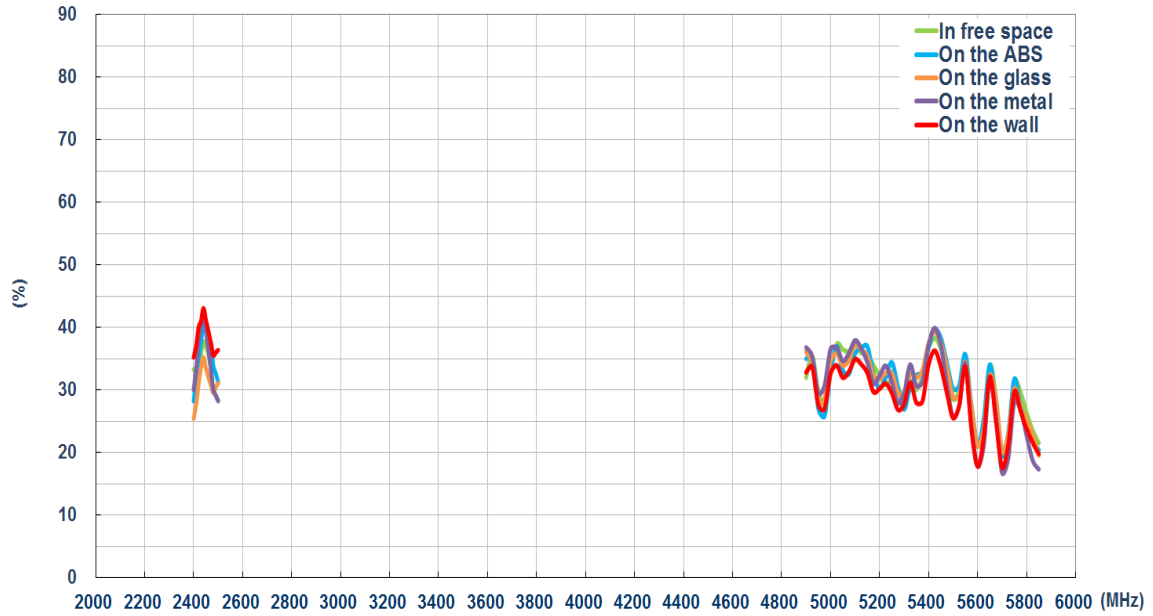

### 3.1.7 Wi-Fi 1 Antenna Average Gain

Performance in different environments with 3 meter cable length

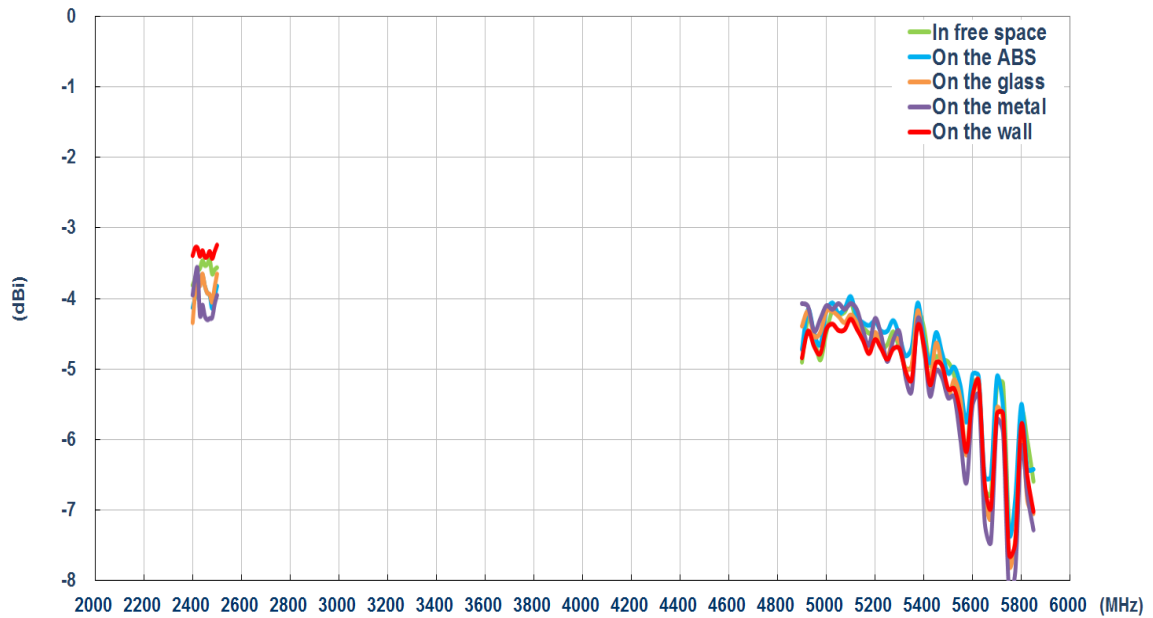



### 3.1.8 Wi-Fi 2 Antenna Average Gain

Performance in different environments with 3 meter cable length

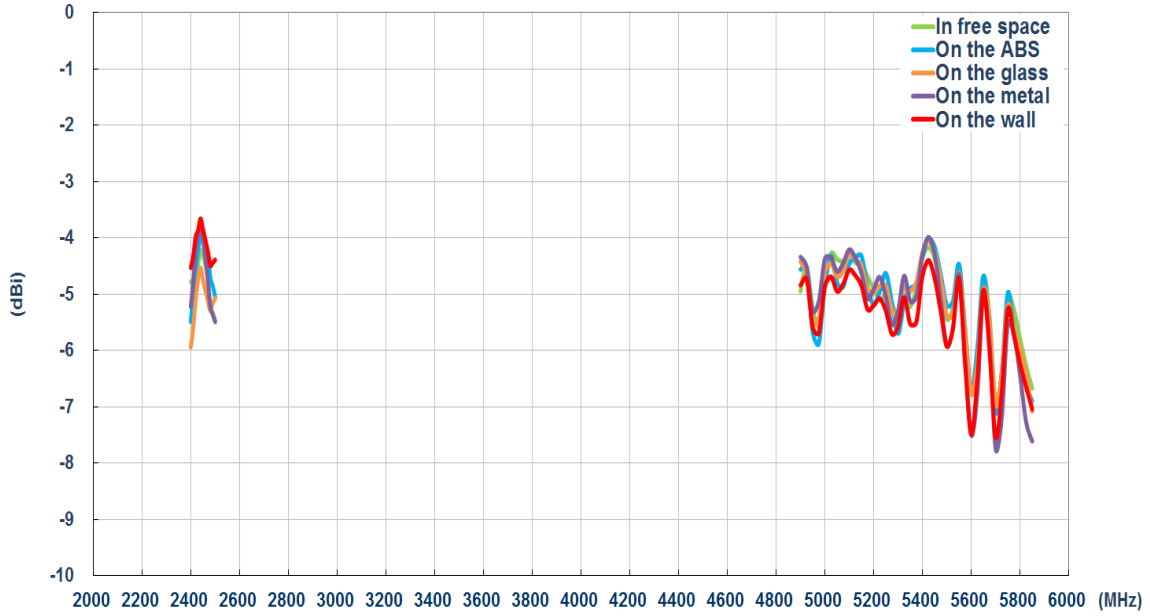

### 3.1.9 Wi-Fi 1 Antenna Peak Gain

Performance in different environments with 3 meter cable length

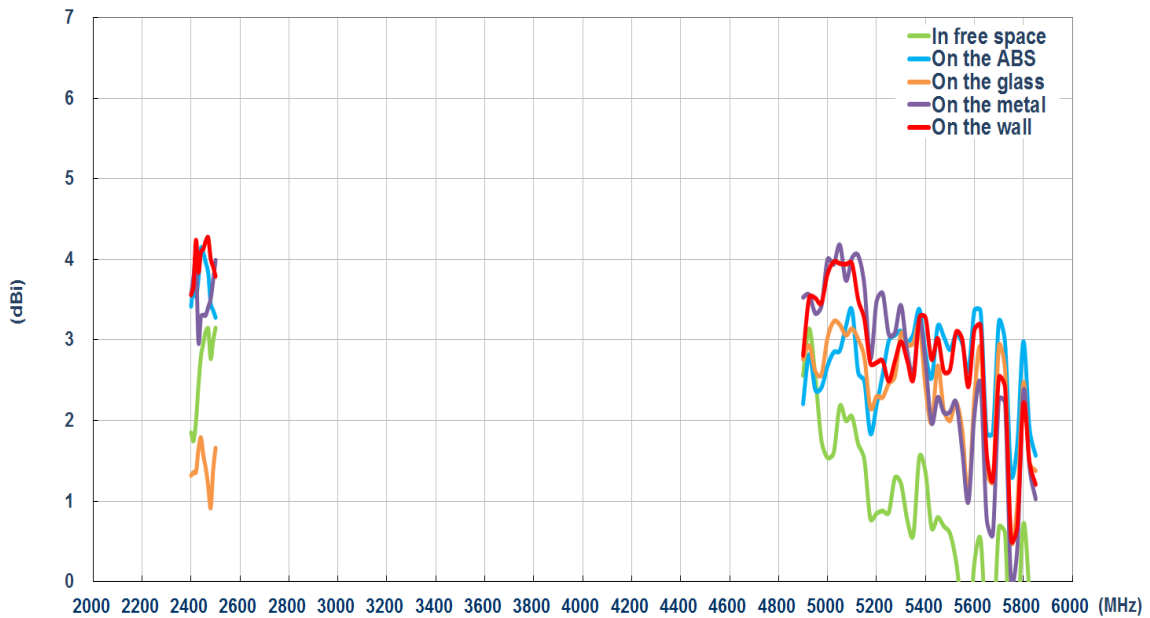

### 3.1.10 Wi-Fi 2 Antenna Peak Gain

Performance in different environments with 3 meter cable length

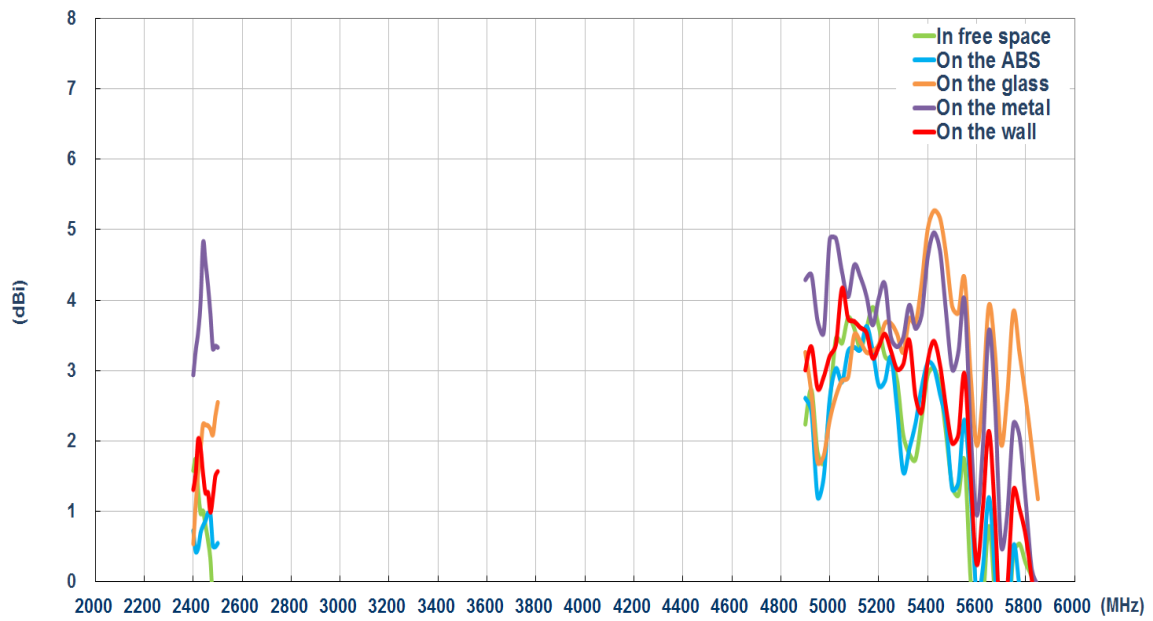

### 3.1.11 Test Setup For Antenna Radiation Pattern

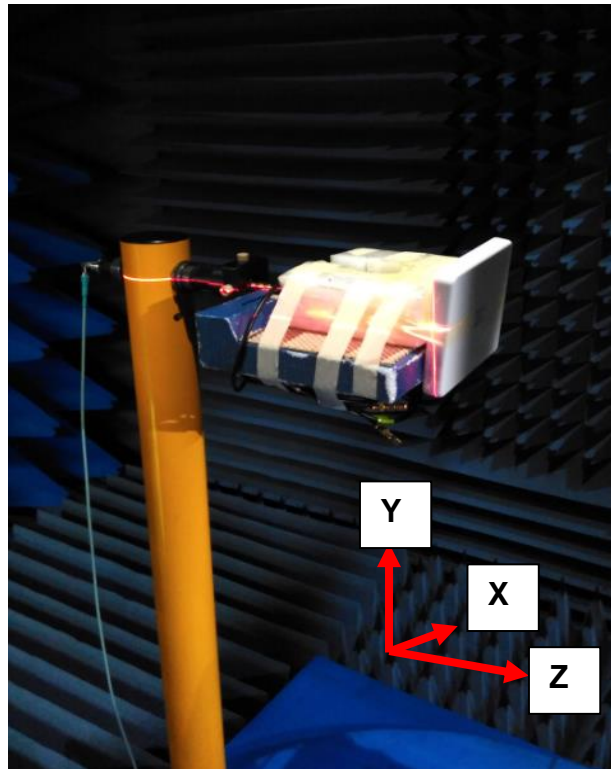

**In free space**

### 3.1.12 2D Radiation Pattern

Wi-Fi\_MIMO1 with 3M cable length in free space

XY Plane

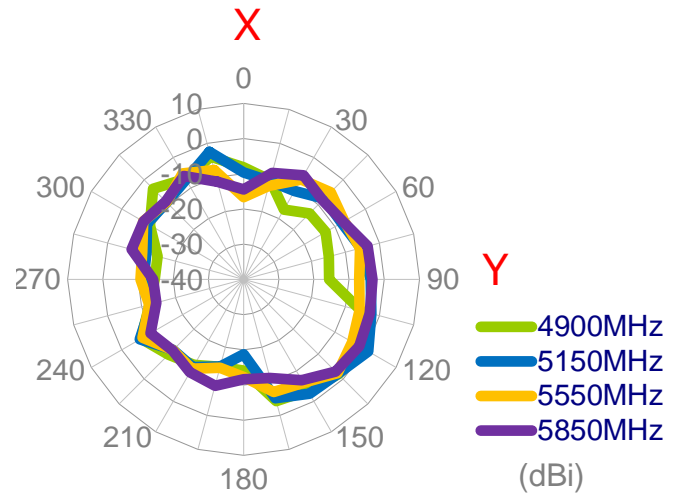
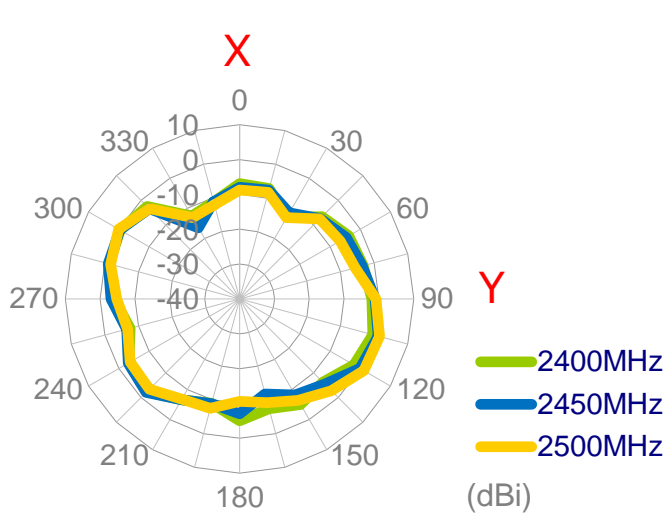

XZ Plane

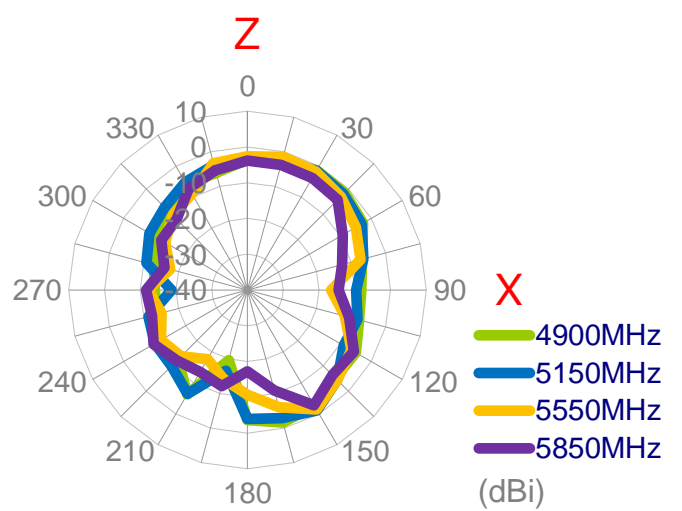
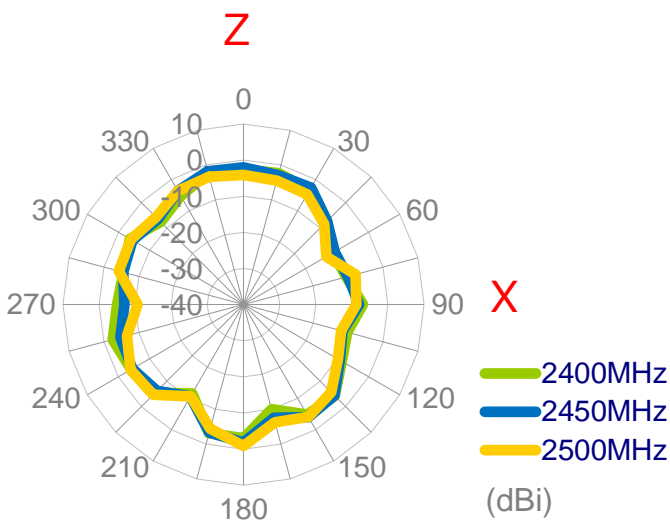

YZ Plane

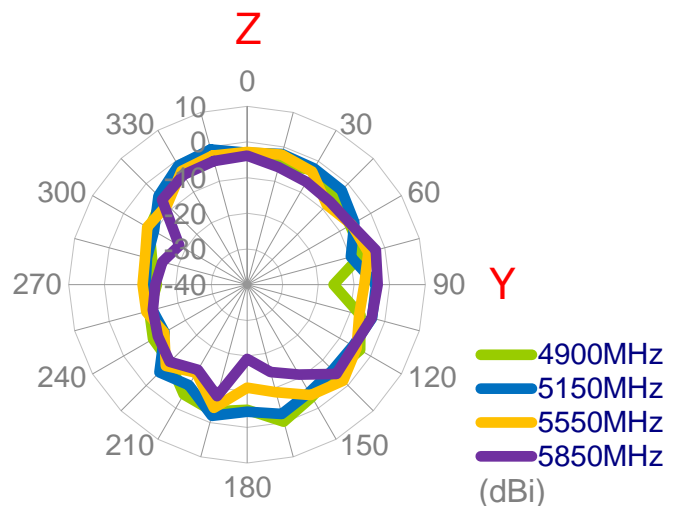
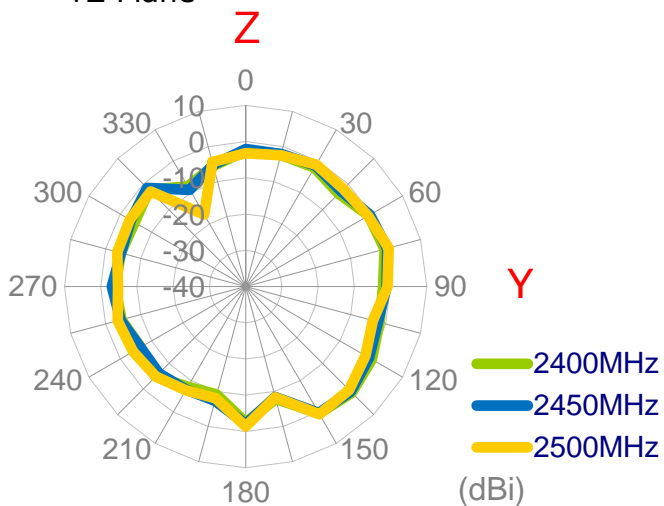

3.1.13 3D Radiation Pattern (Wi-Fi\_MIMO1 with 3M cable length in free space)

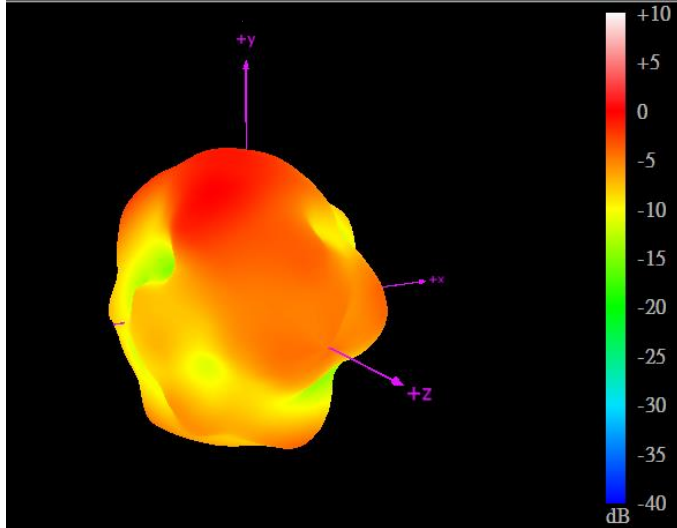

2450MH

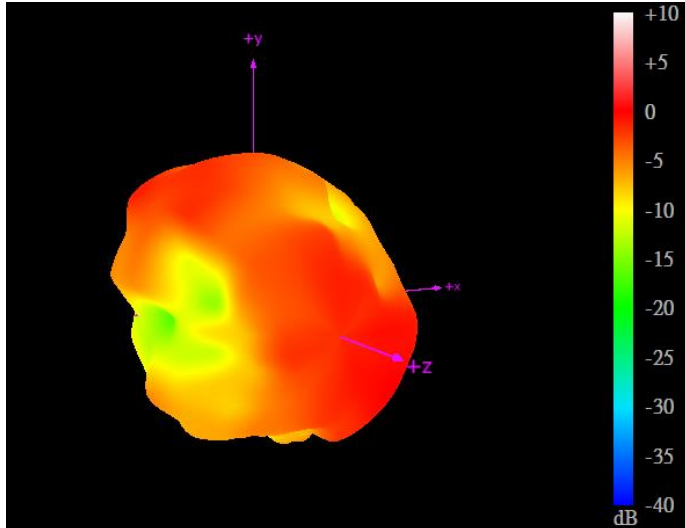

5550MHz

### 3.1.14 2D Radiation Pattern

Wi-Fi MIMO2 with 3M cable length in free space

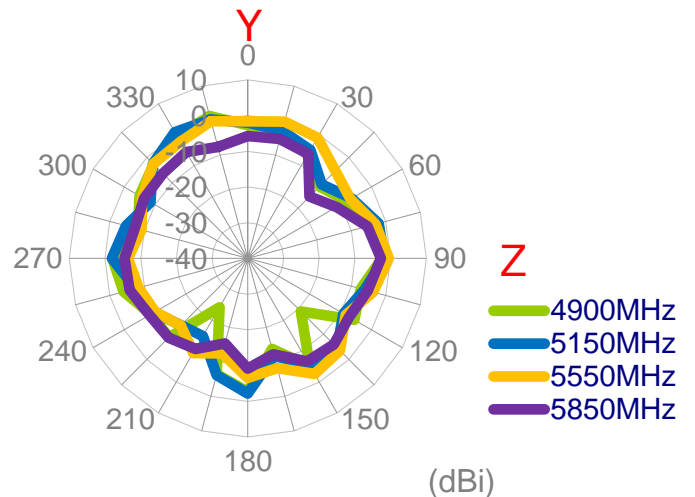
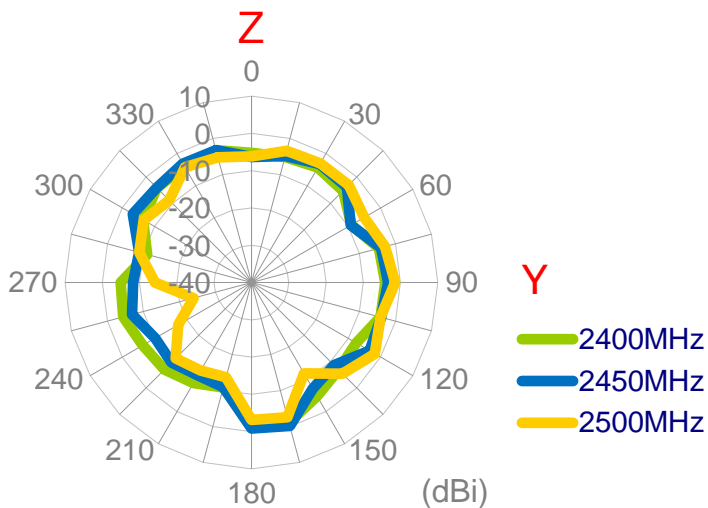
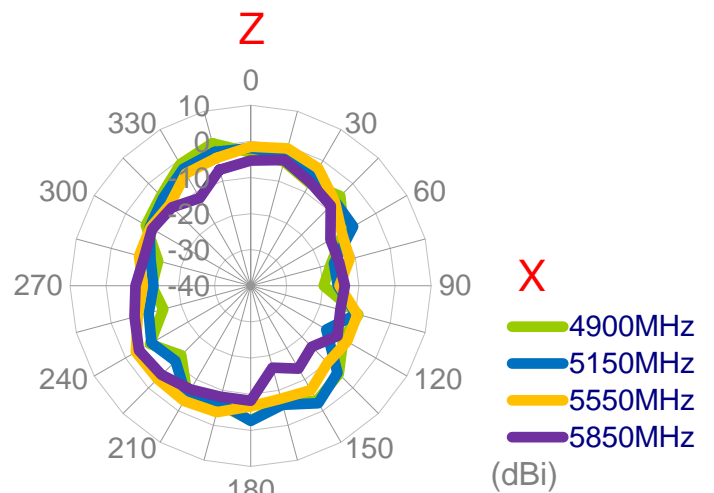
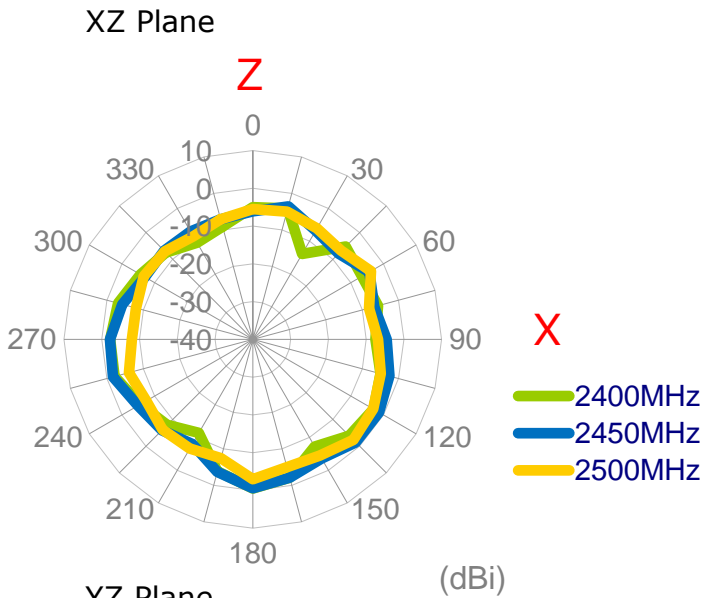
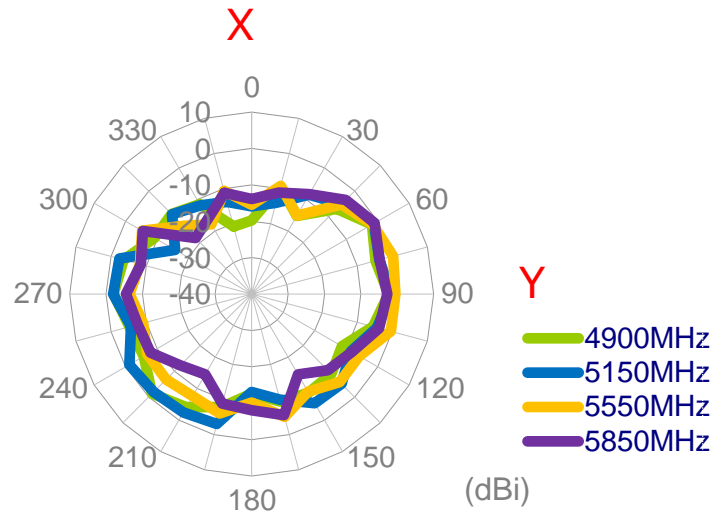
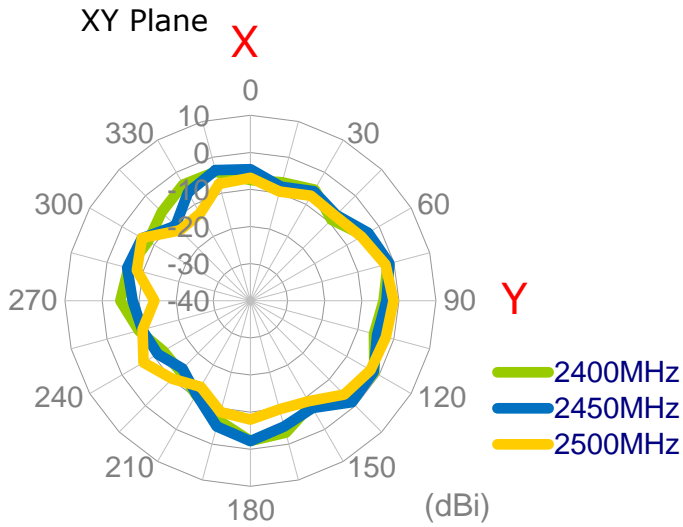

3.1.15 3D Radiation Pattern  
Wi-Fi MIMO2 with 3M cable length in free space

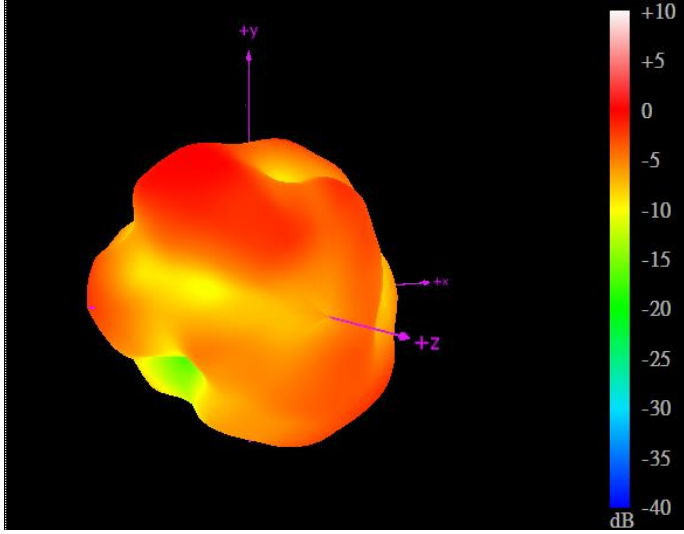

2450MHz

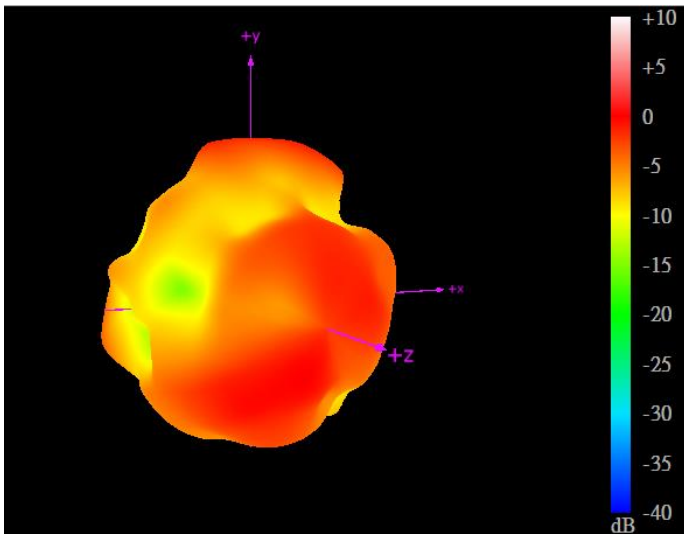

5550MHz

### 3.1.16 Test Setup for Antenna Radiation Pattern

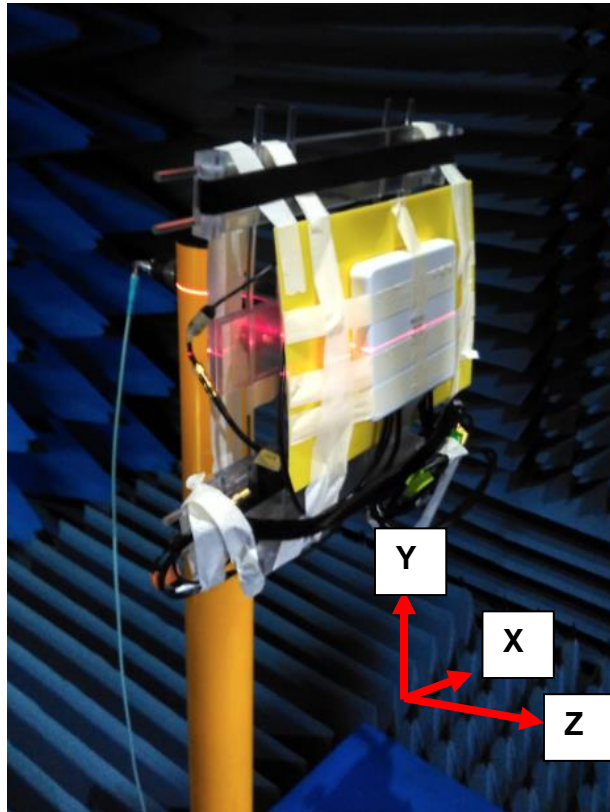

**On the ABS**



### 3.1.17 2D Radiation Pattern

Wi-Fi MIMO1 with 3M cable length on the ABS

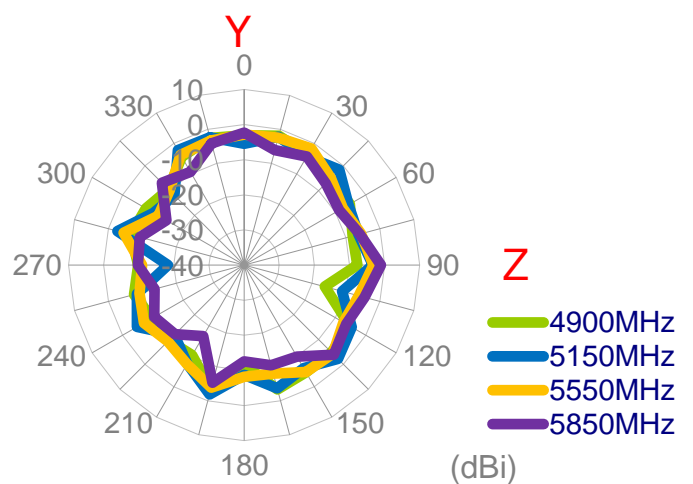
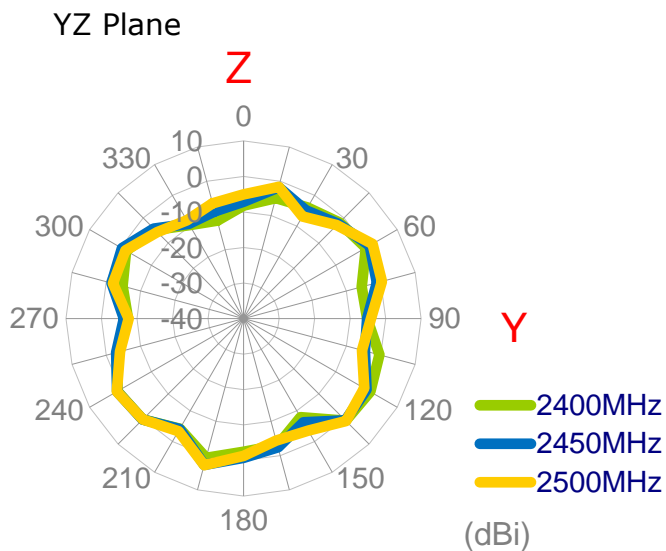
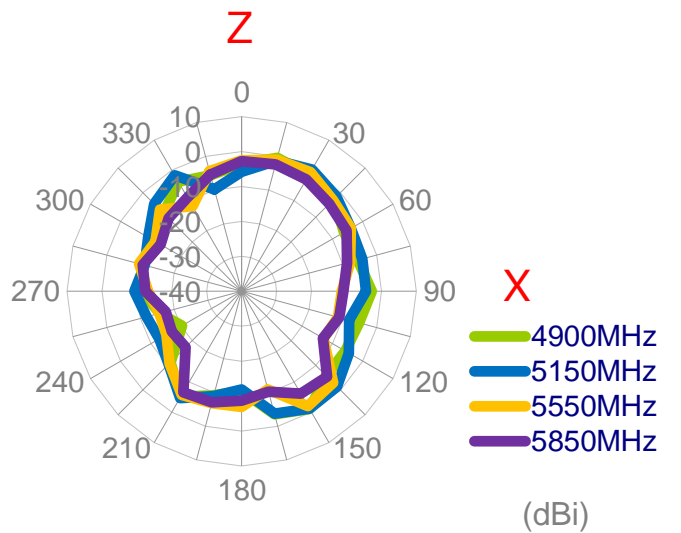
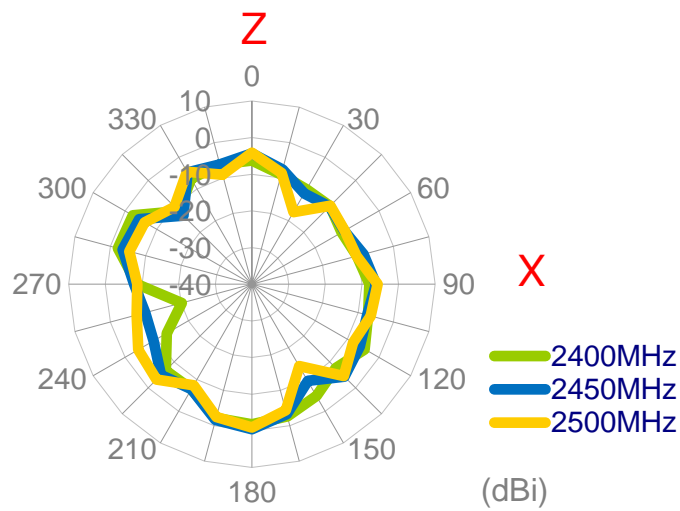
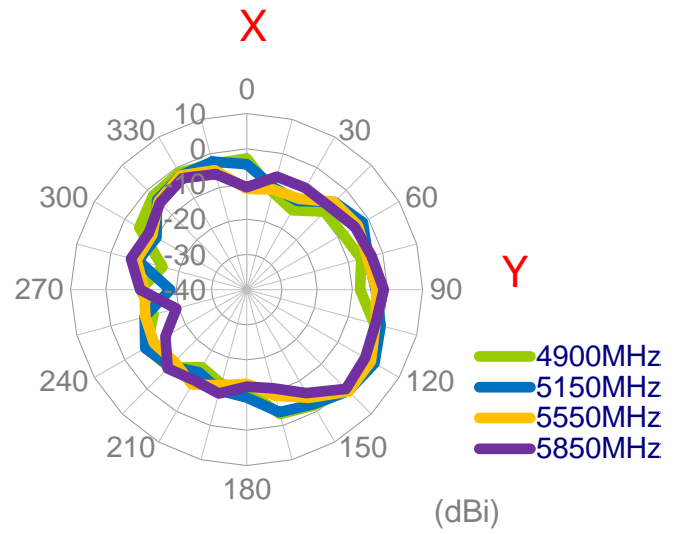
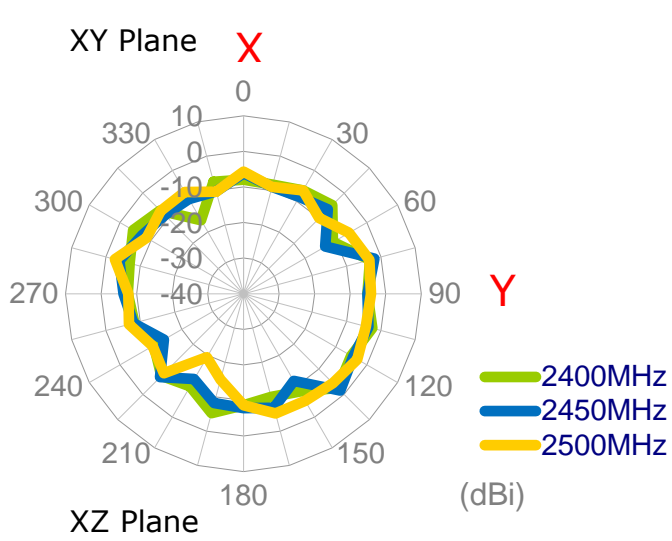

3.1.18 3D Radiation Pattern (Wi-Fi\_MIMO1 with 3M cable length on the ABS)

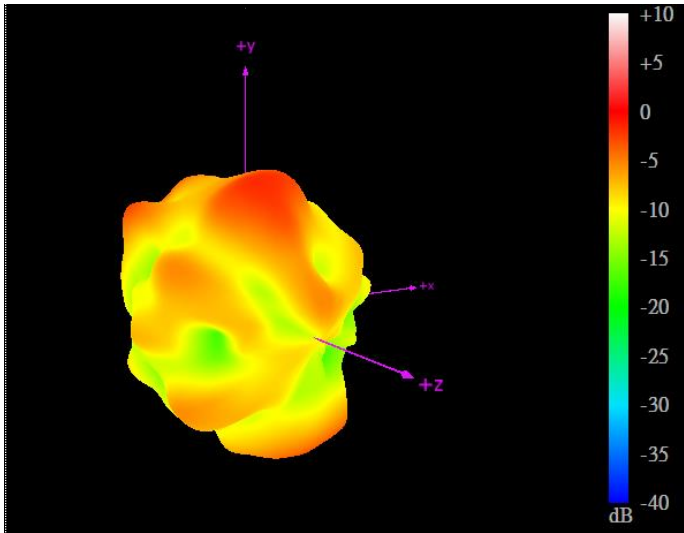

2450MHz

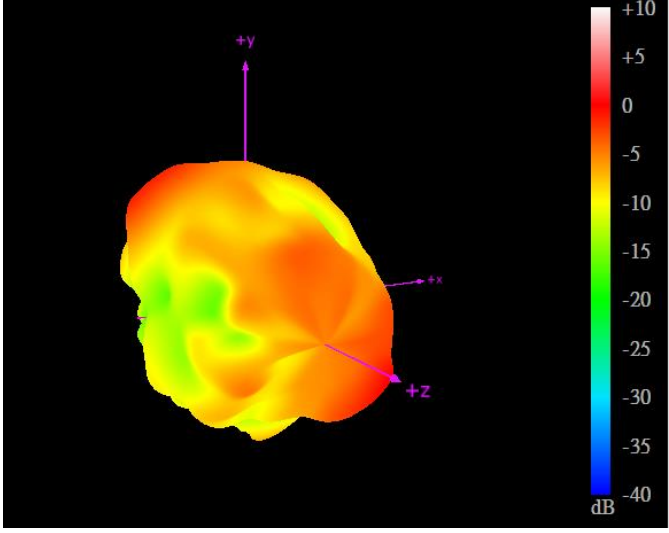

5550MHz

### 3.1.19 2D Radiation Pattern

Wi-Fi\_MIMO2 with 3M cable length on the ABS

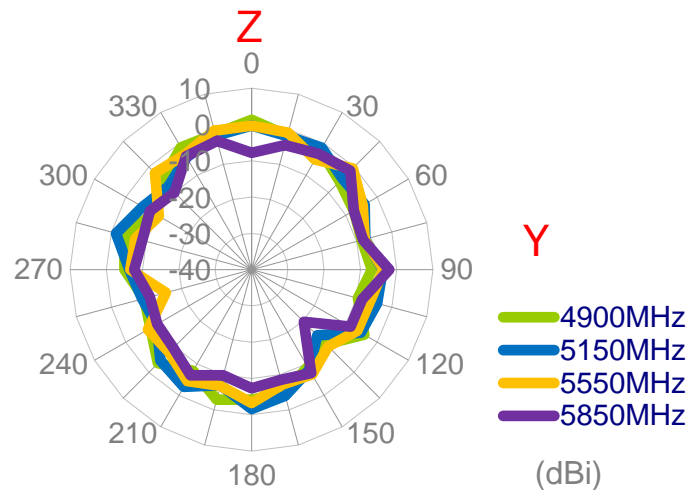
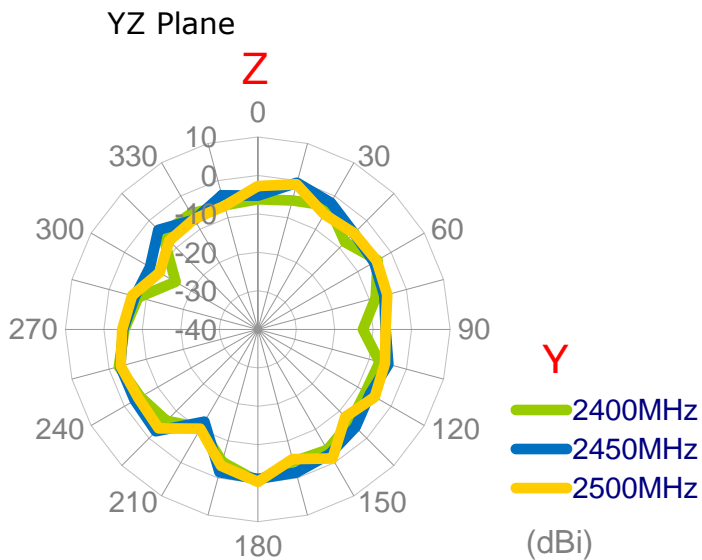
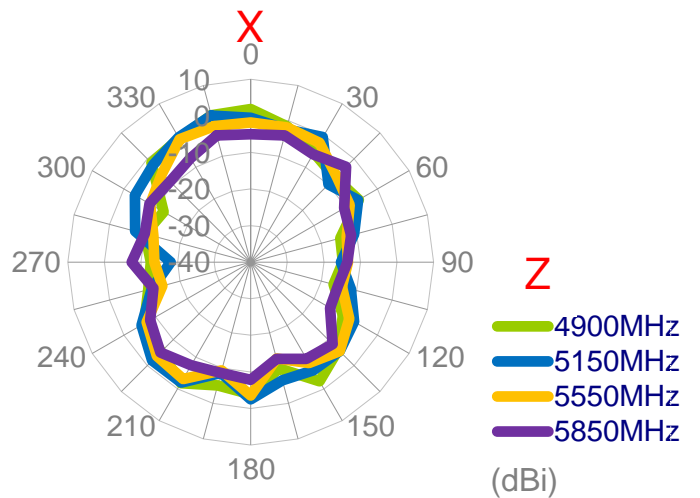
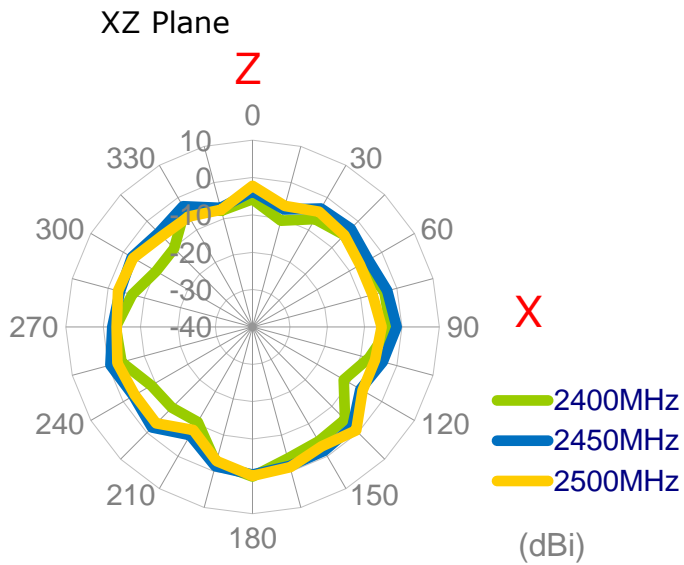
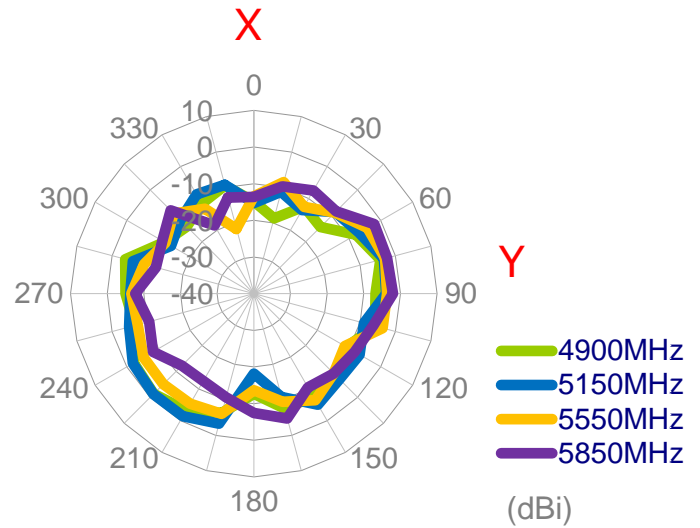
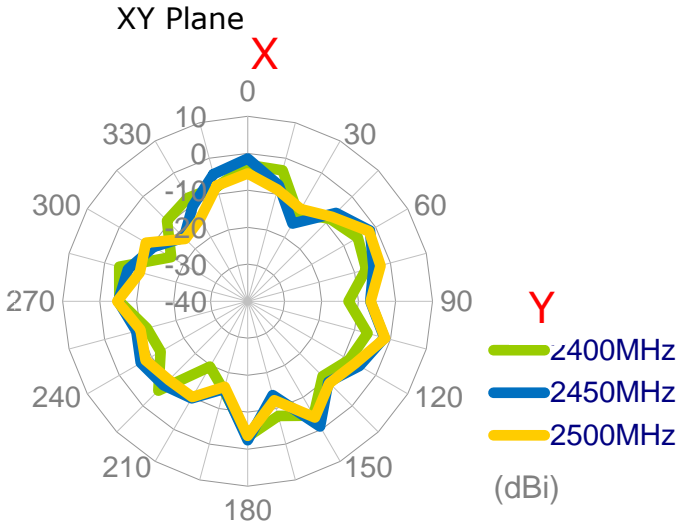

3.1.20 3D Radiation Pattern  
Wi-Fi MIMO2 with 3M cable length on the ABS

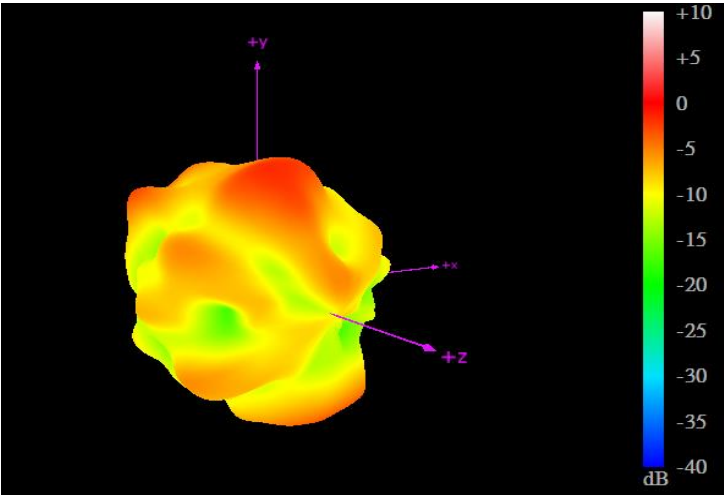

2450MH

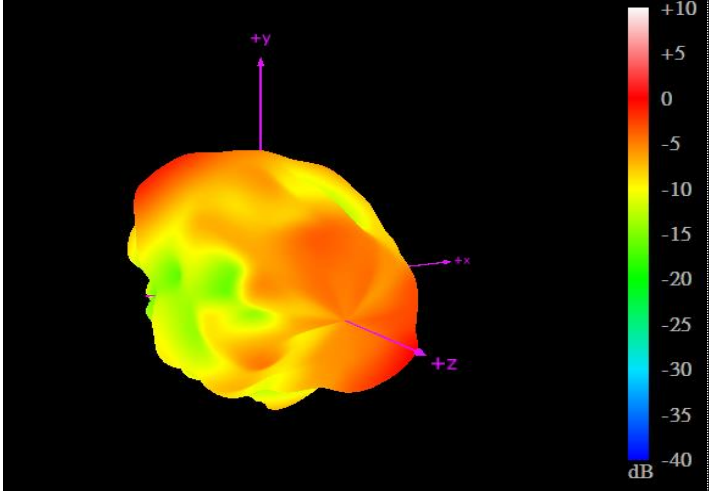

5550MH

### 3.1.21 Test Setup For Antenna Radiation Pattern

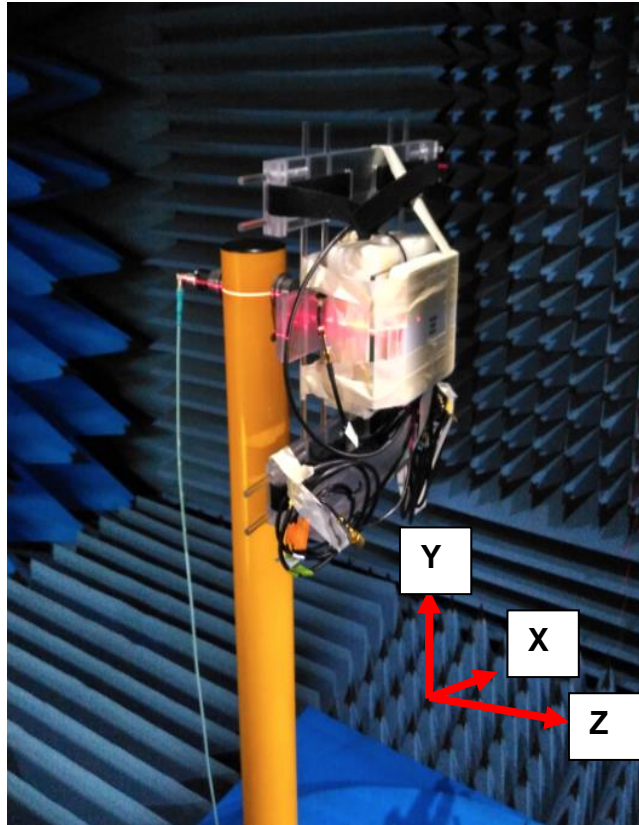

On the glass

3.1.22 2D Radiation Pattern  
 Wi-Fi MIMO1 with 1M cable length on the glass

XY Plane

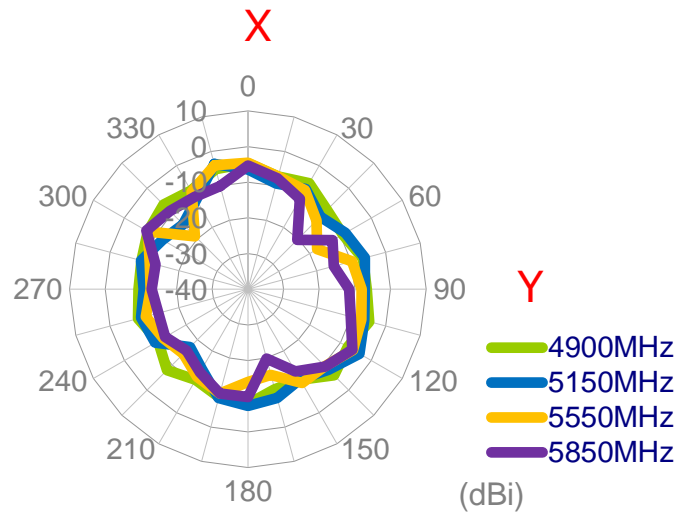
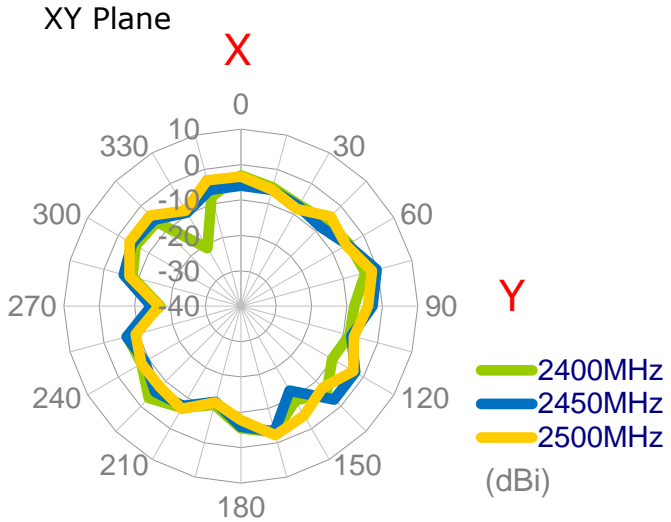

XZ Plane

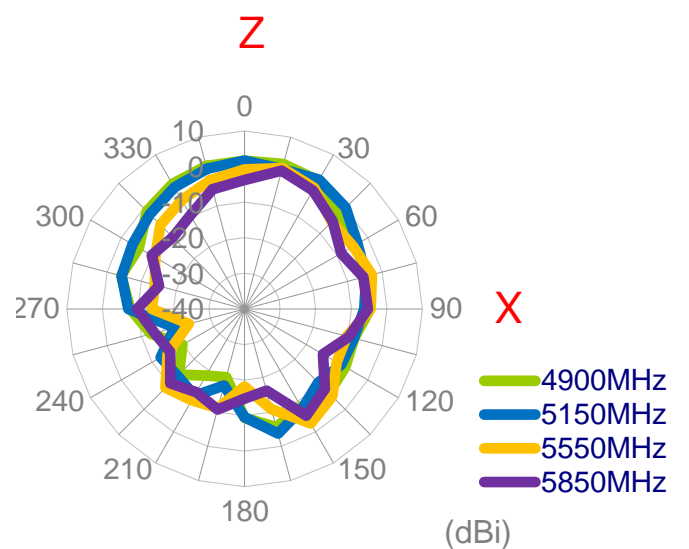
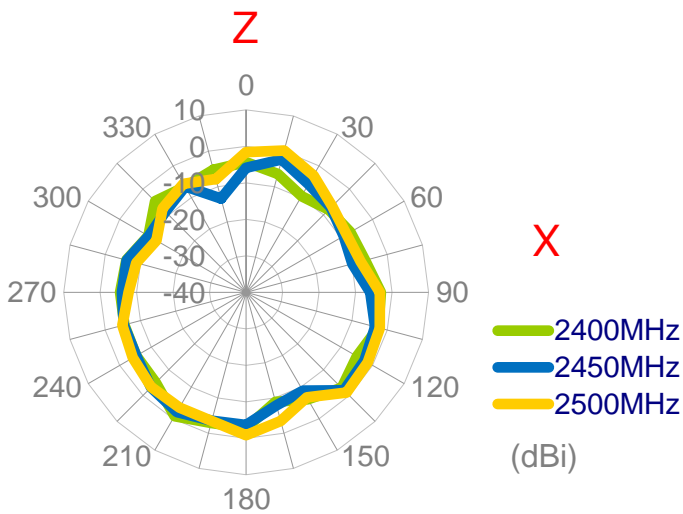

YZ Plane

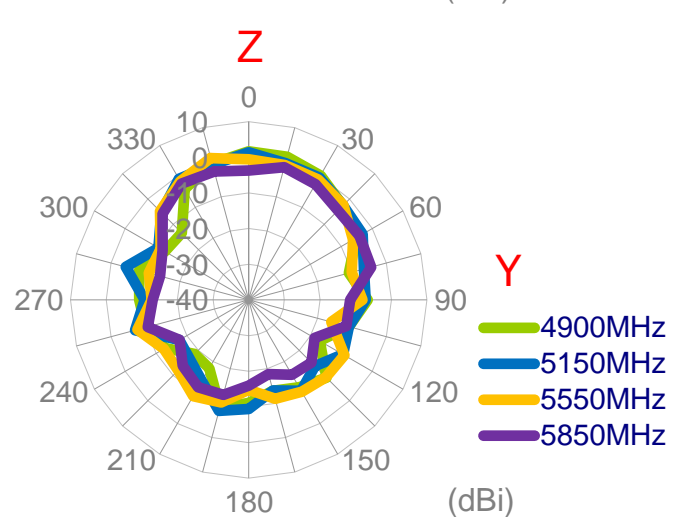
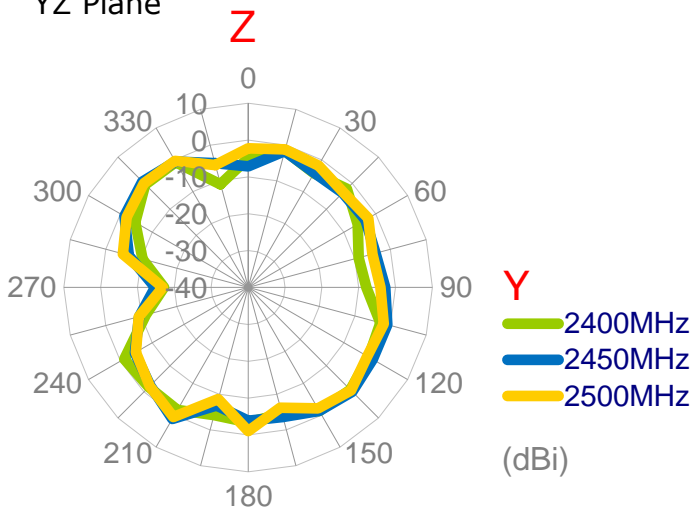

3.1.23 3D Radiation Pattern  
Wi-Fi MIMO1 with 3M cable length on the glass

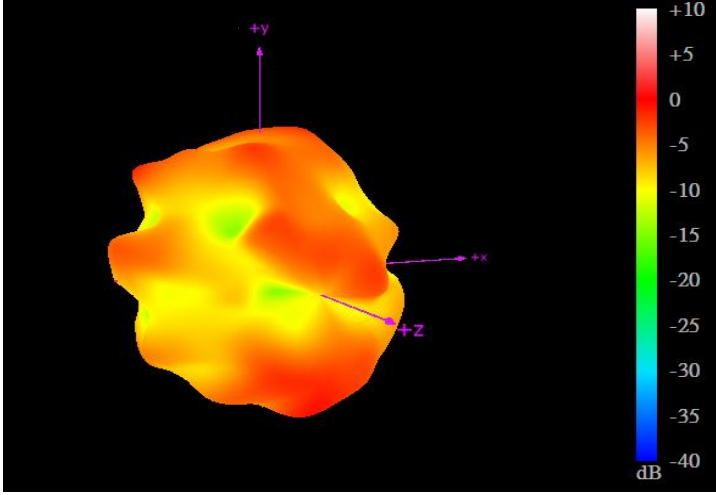

2450MHz

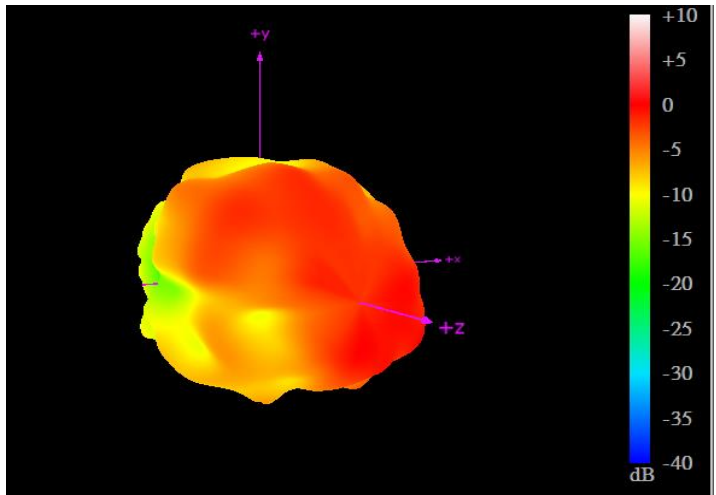

5550MHz

3.1.24 2D Radiation Pattern  
 Wi-Fi MIMO2 with 3M cable length on the glass

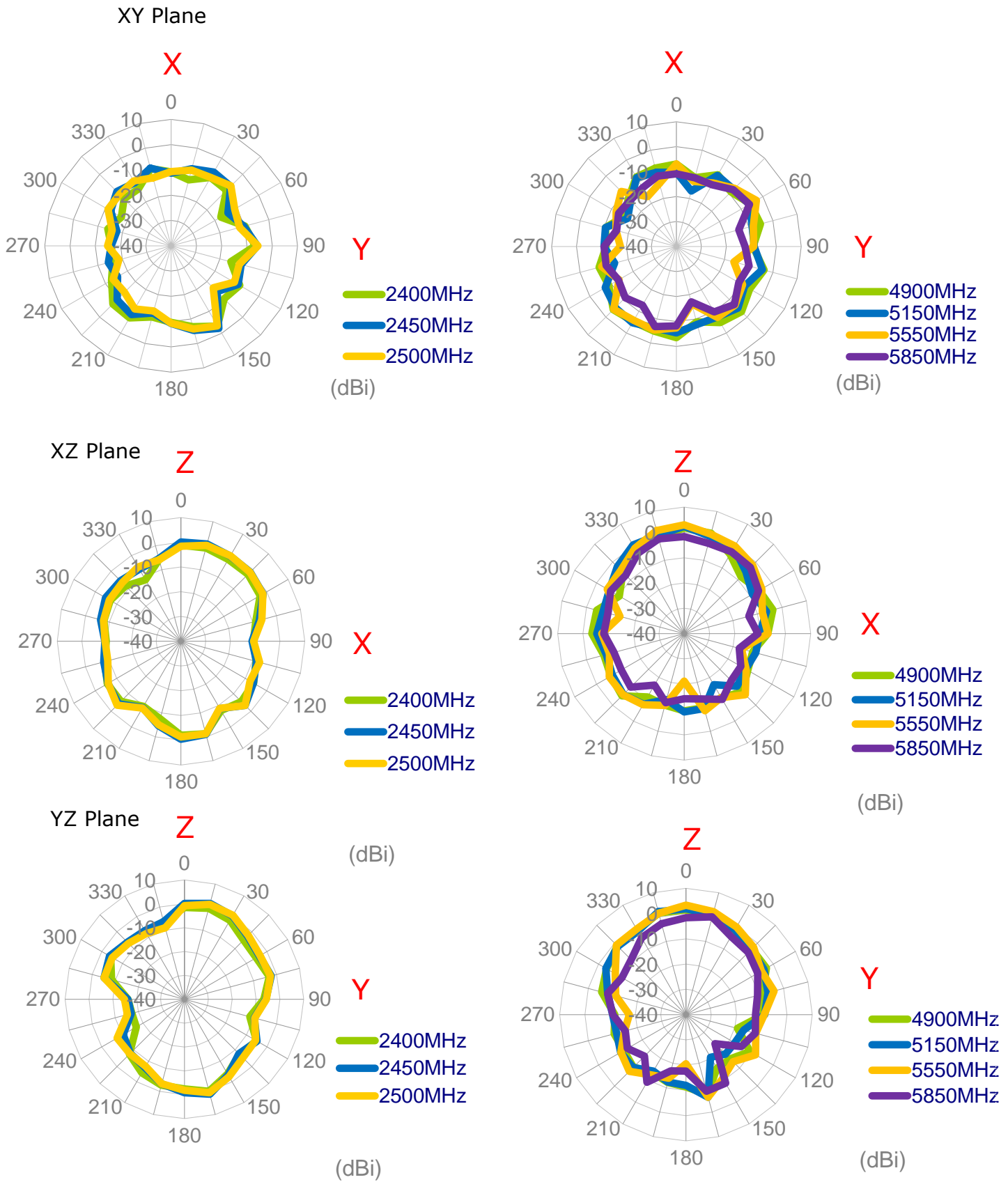



3.1.25 3D Radiation Pattern  
Wi-Fi MIMO2 with 3M cable length on the glass

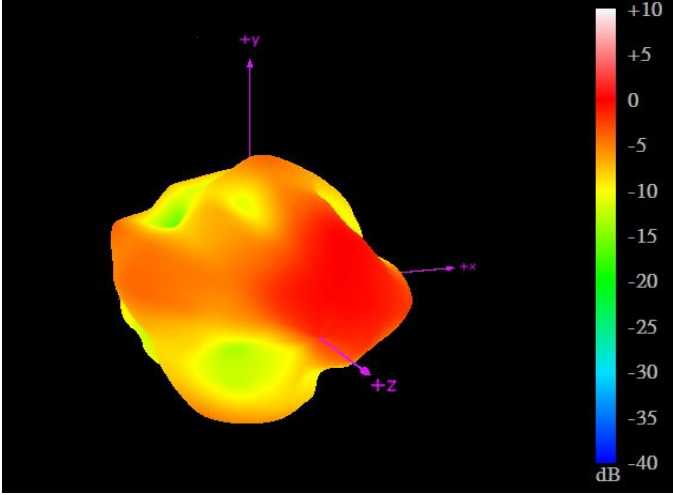

2450MHz

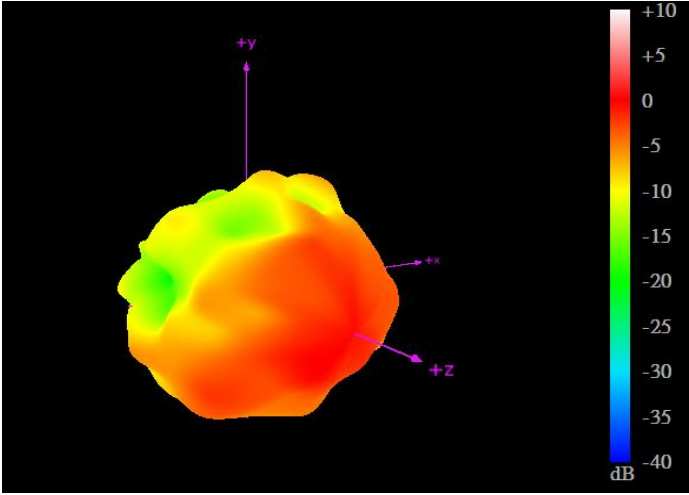

5550MHz

### 3.1.26 Test Setup For Antenna Radiation Pattern

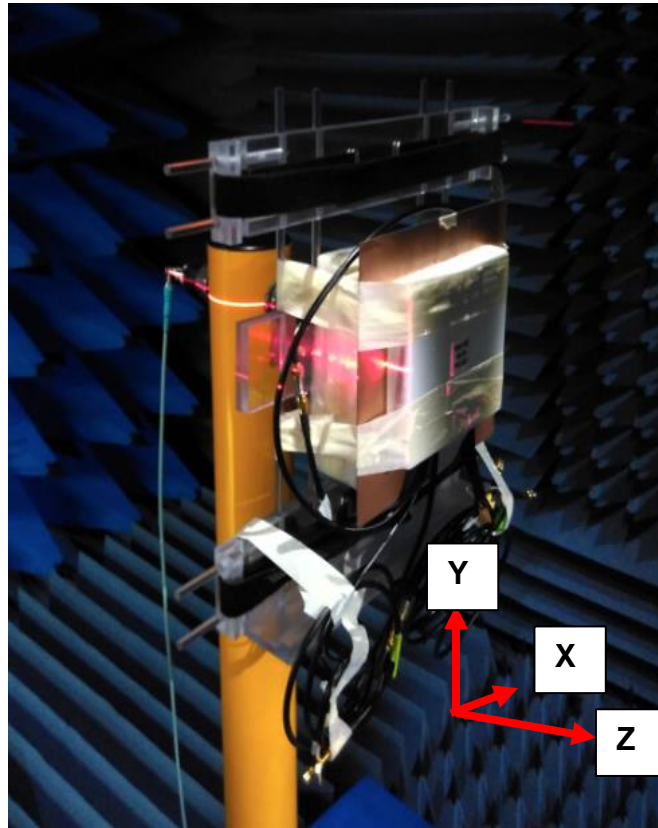

**On the metal**

### 3.1.27 2D Radiation Pattern

Wi-Fi MIMO1 with 3M cable length on the metal

XY Plane

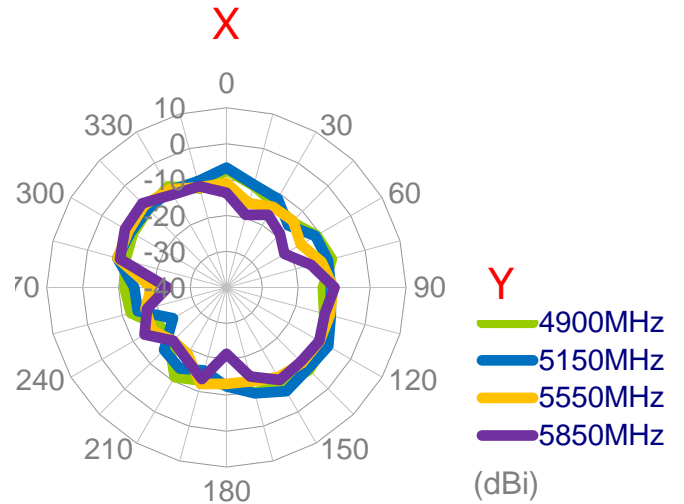
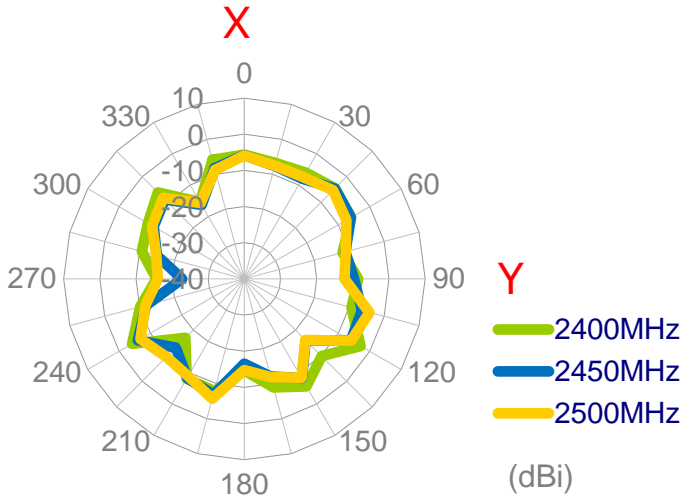

XZ Plane

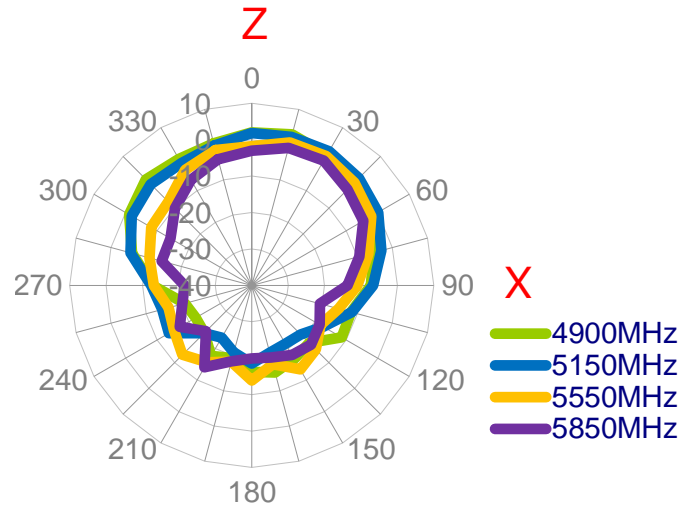
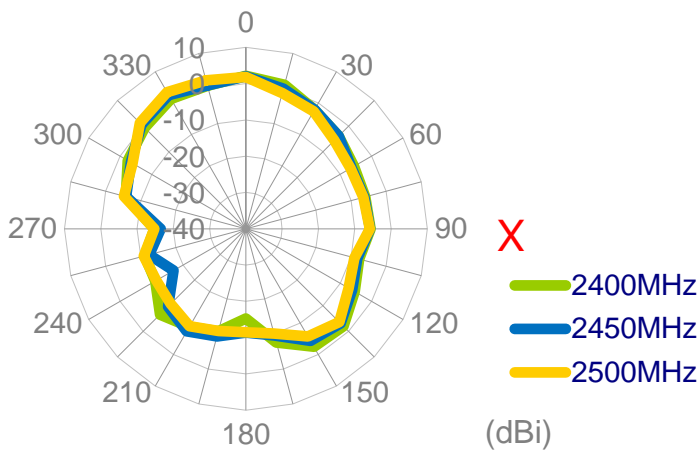

YZ Plane

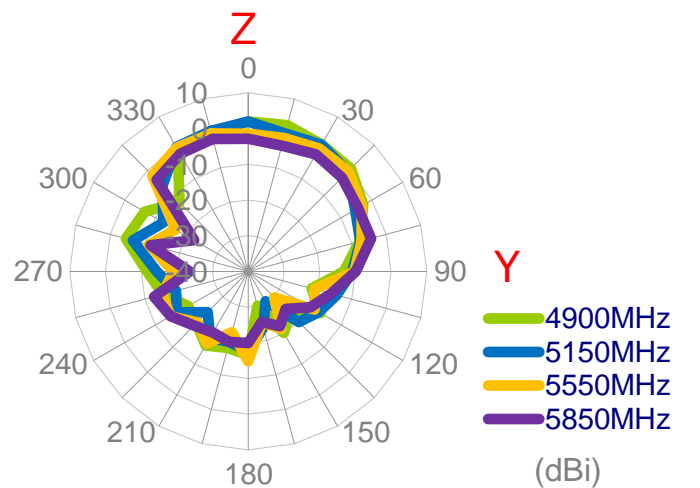
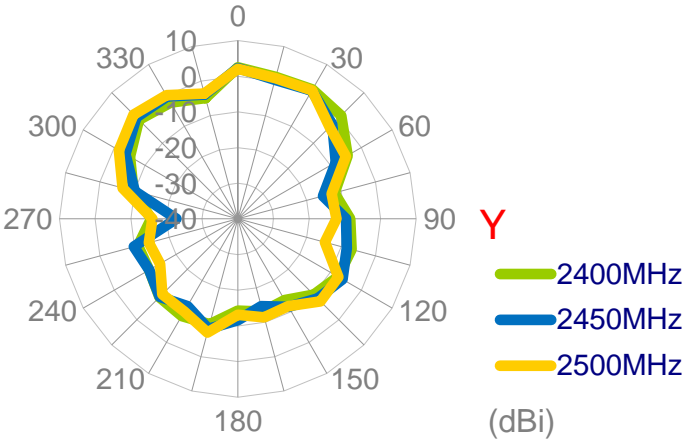

3.1.28 3D Radiation Pattern  
(Wi-Fi MIMO1 with 3M cable length on the metal)

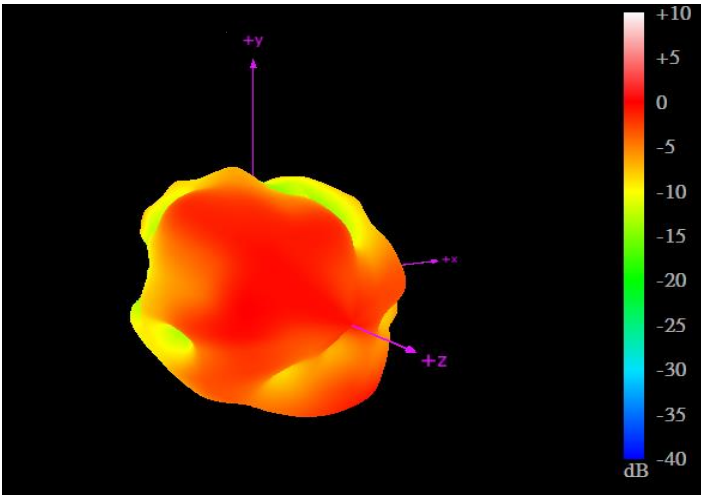

2450MHz

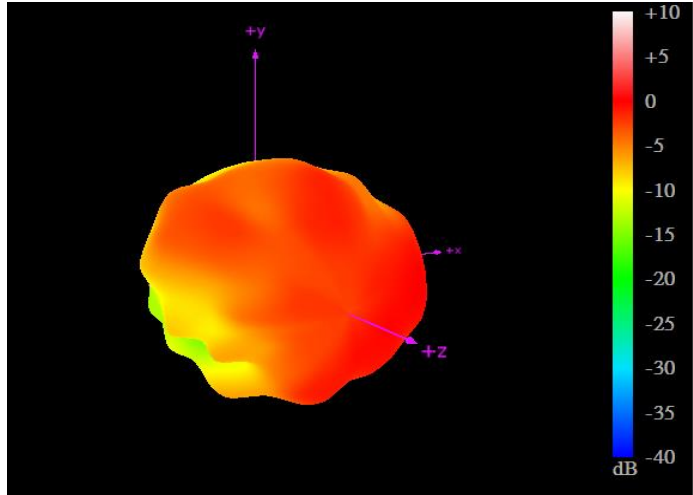

5550MHz

### 3.1.29 2D Radiation Pattern

Wi-Fi\_MIMO2 with 3M cable length on the metal

XY Plane

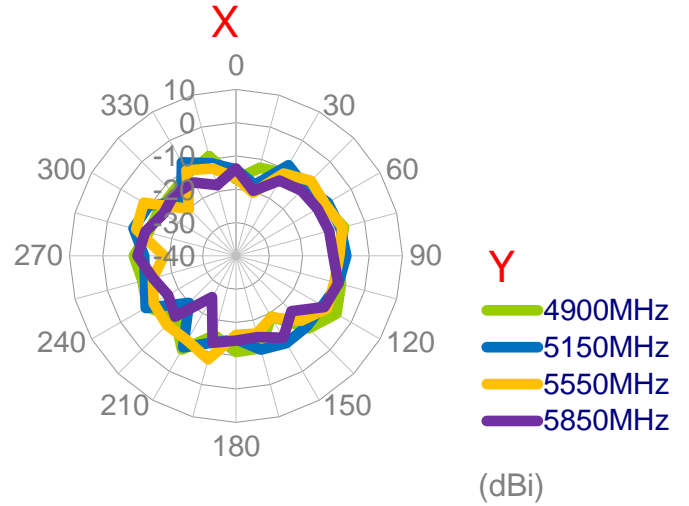
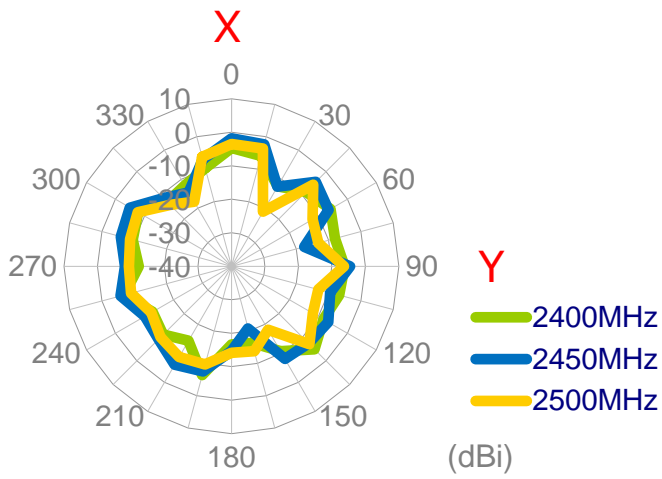

XZ Plane

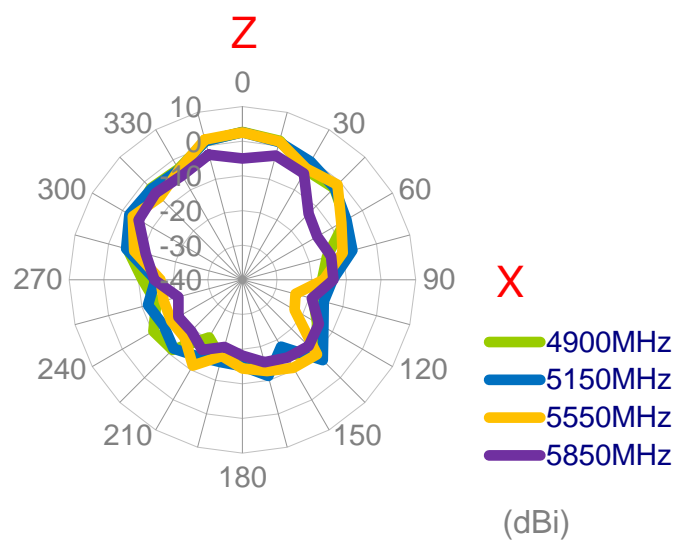
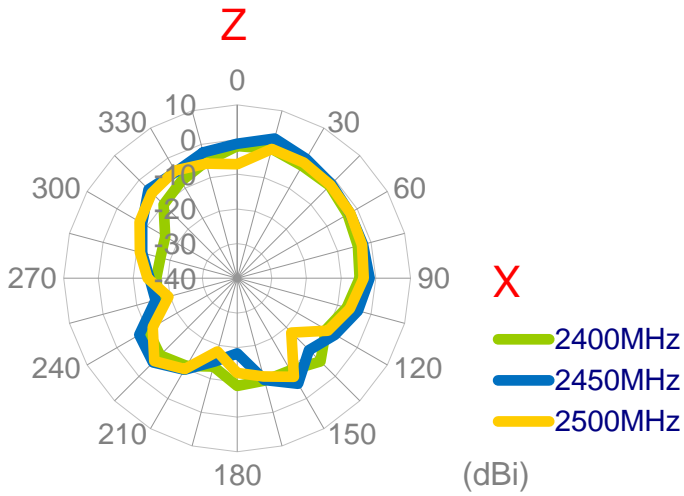

YZ Plane

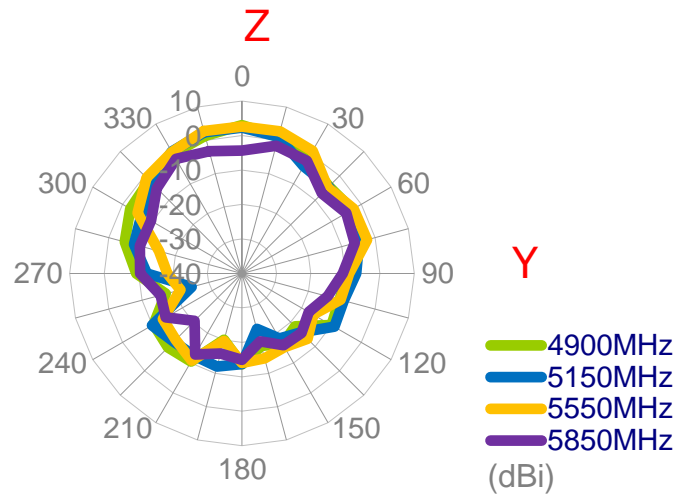
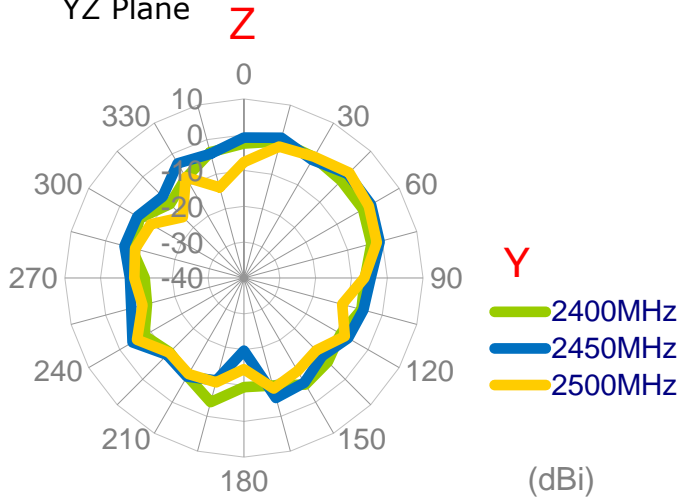

3.1.30 3D Radiation Pattern  
Wi-Fi MIMO2 with 3M cable length on the metal

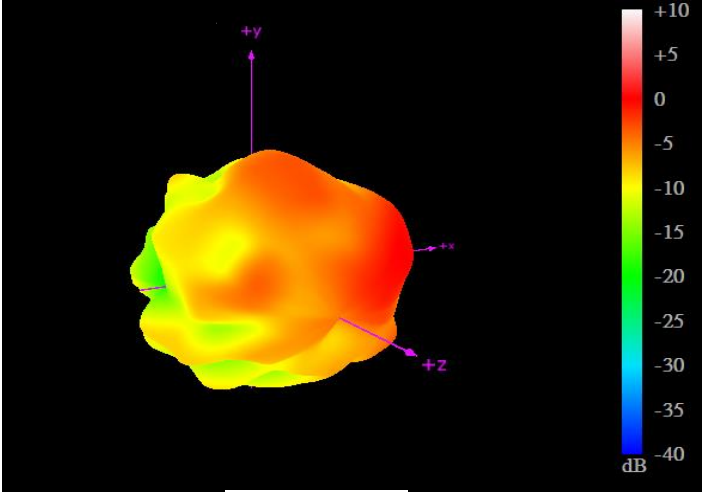

2450MHz

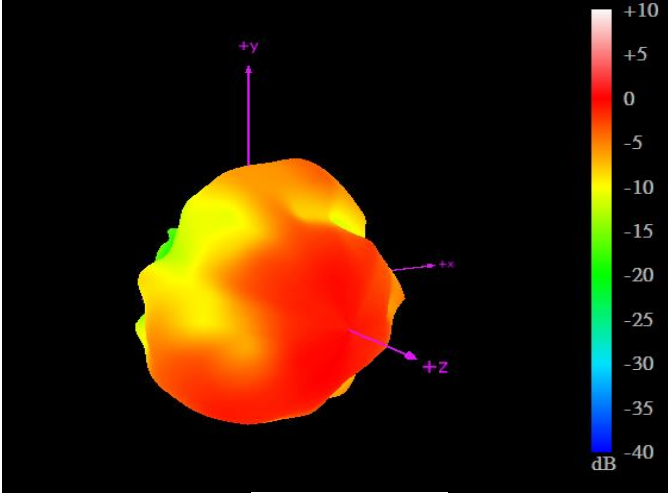

5550MHz

3.1.31 Test Setup For Antenna Radiation Pattern

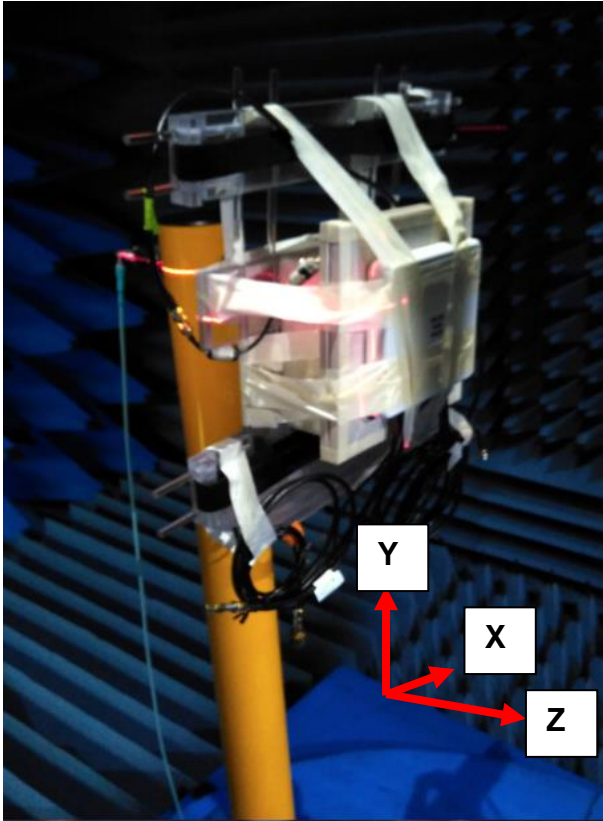

On the Wall

### 3.1.32 2D Radiation Pattern

Wi-Fi\_MIMO1 with 3M cable length in free space

XY Plane

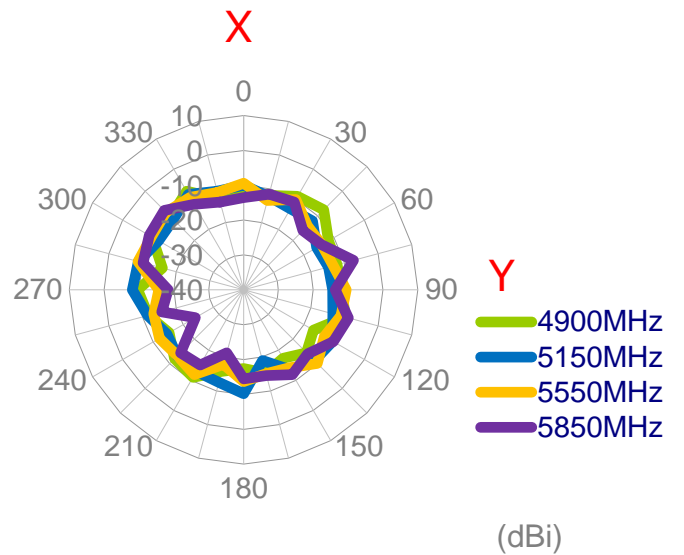
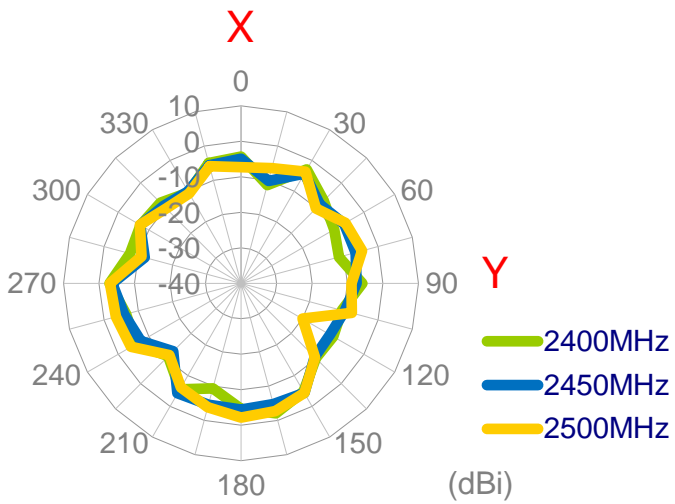

XZ Plane

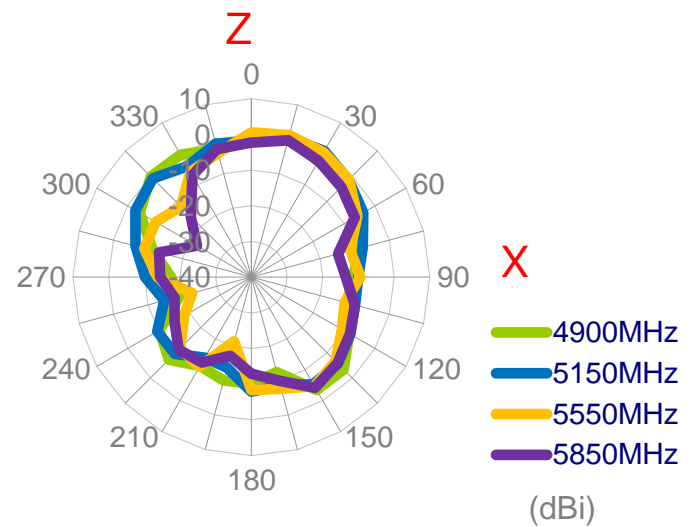
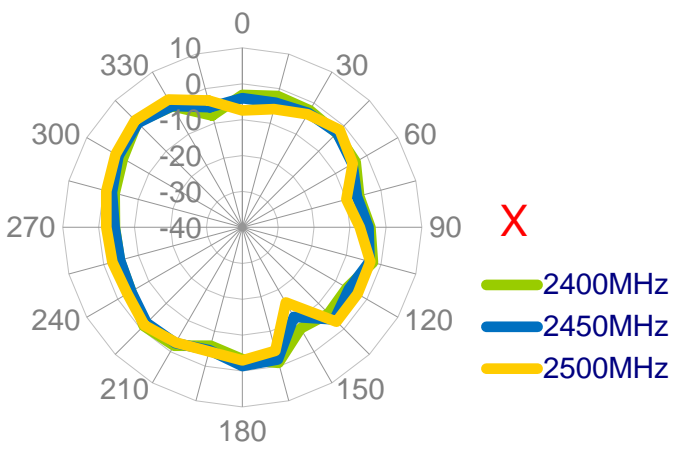

YZ Plane

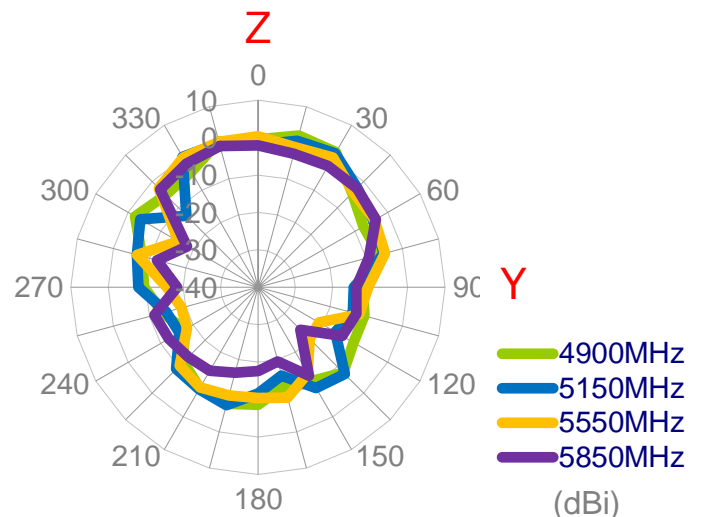
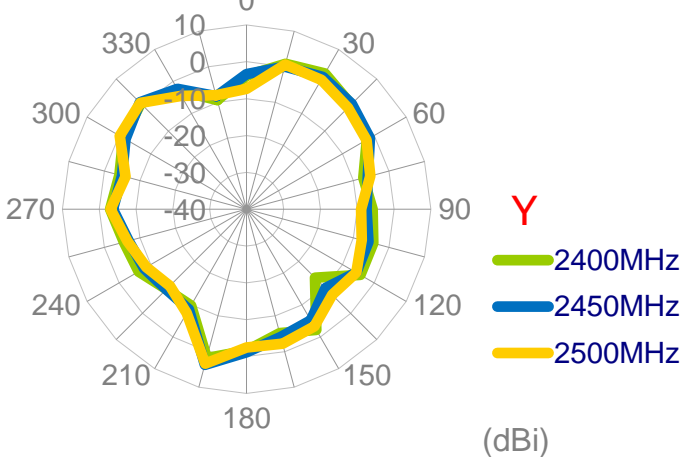



3.1.33 3D Radiation Pattern  
Wi-Fi MIMO1 with 3M cable length in free space

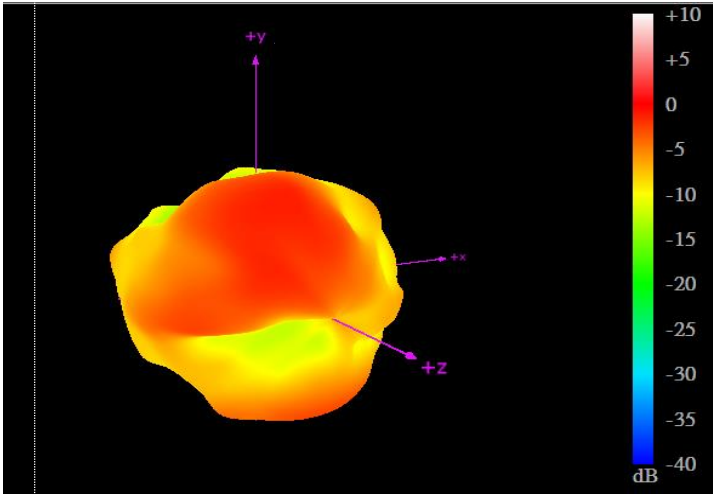

2450MHz

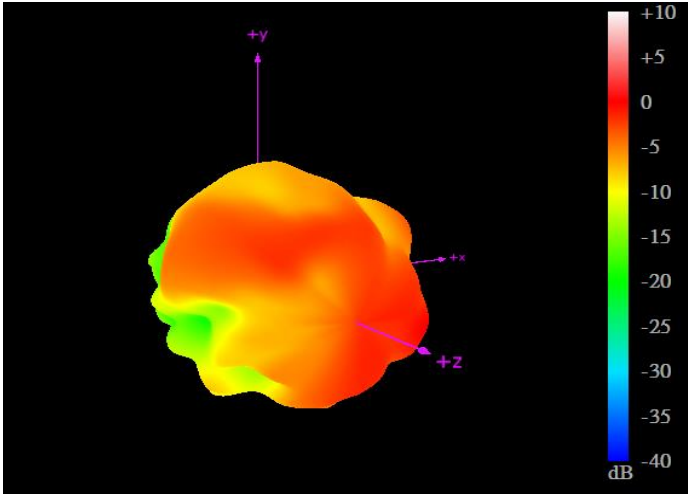

5550MHz

### 3.1.34 2D Radiation Pattern

Wi-Fi MIMO2 with 3M cable length in free space

XY Plane

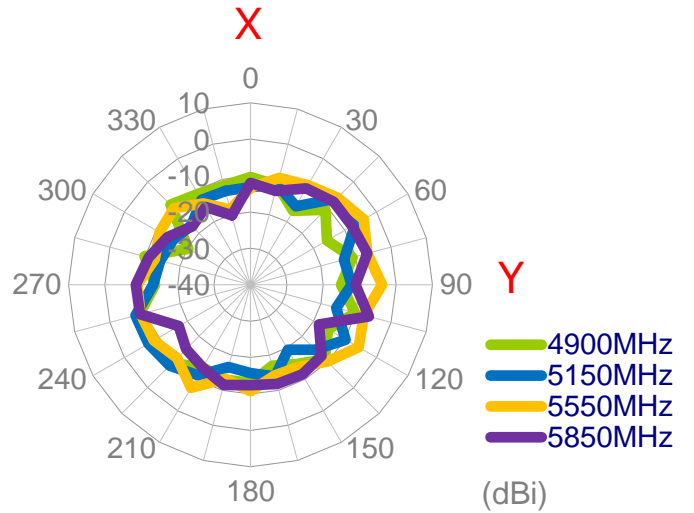
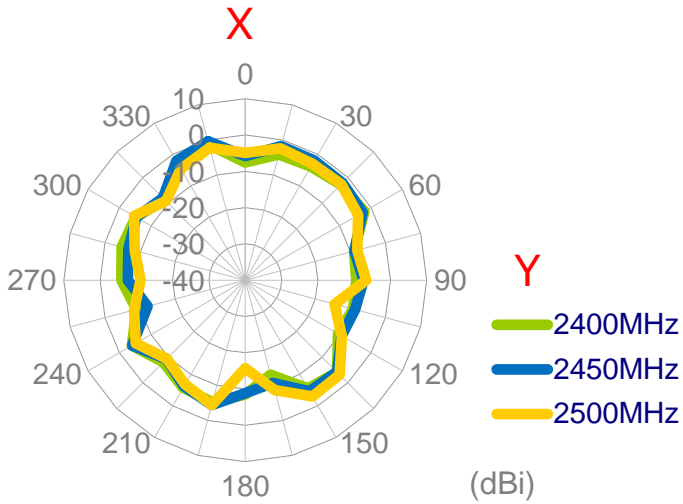

XZ Plane

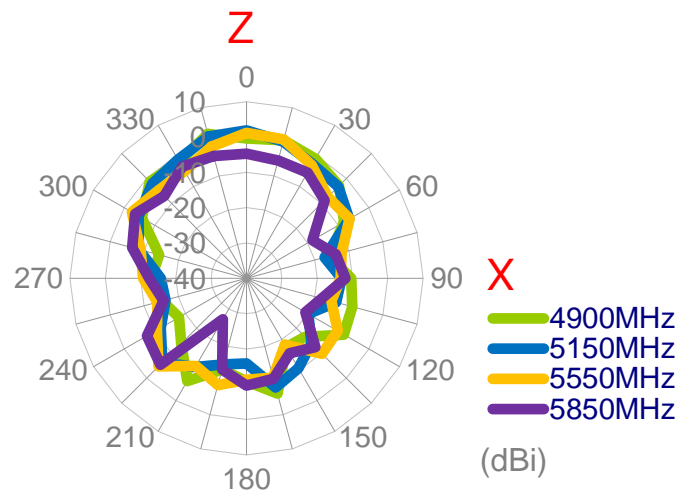
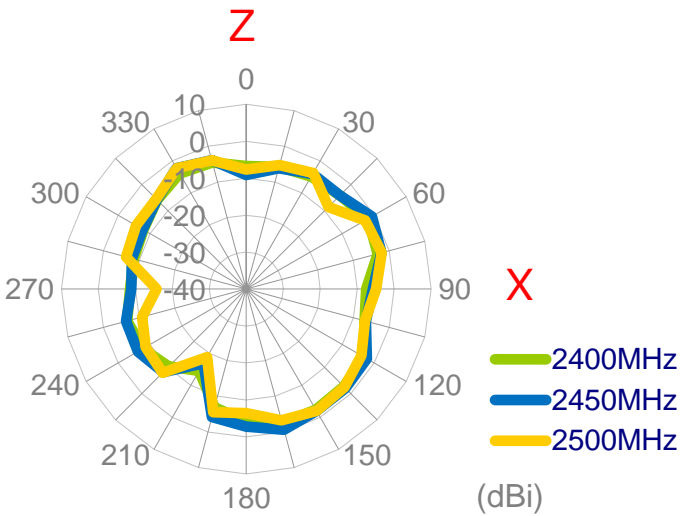

YZ Plane

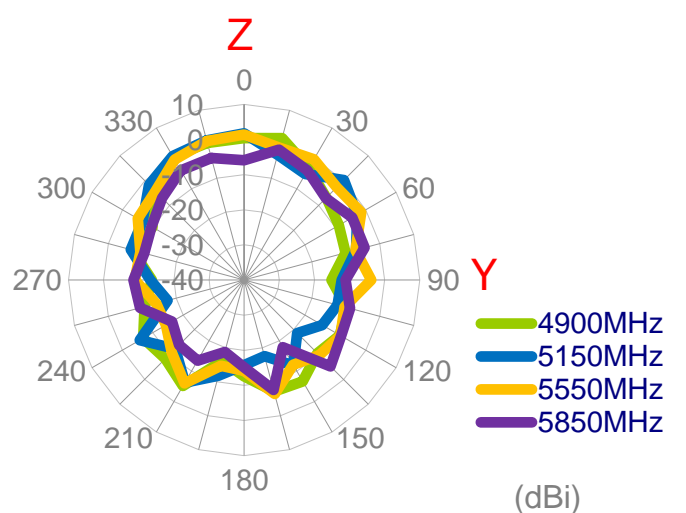
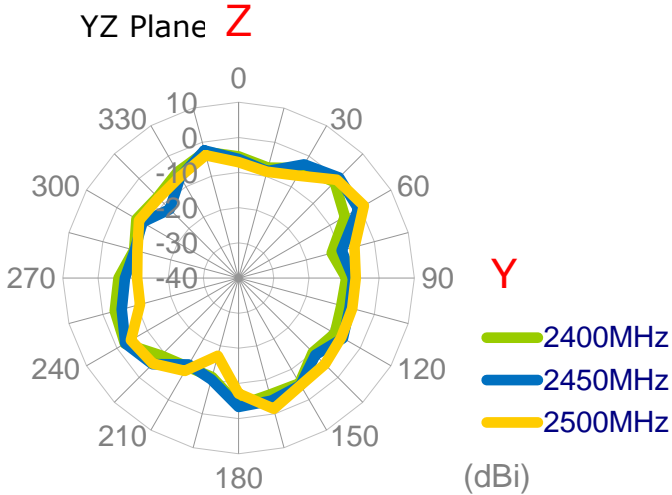

3.1.35 3D Radiation Pattern  
Wi-Fi MIMO2 with 3M cable length in free space

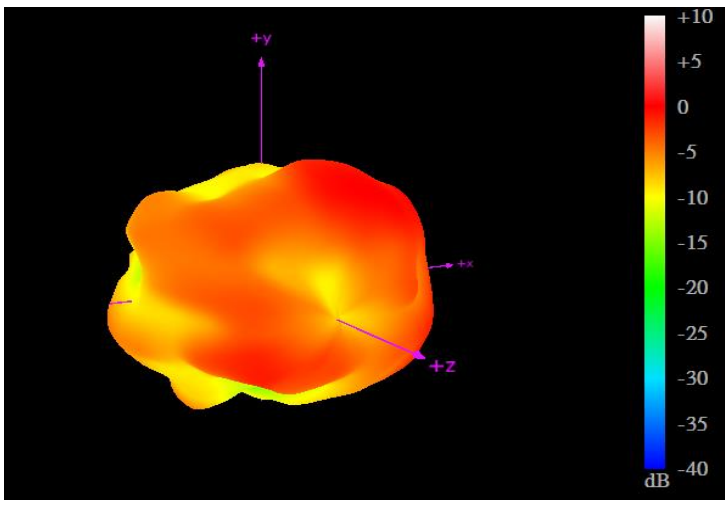

2450MHz

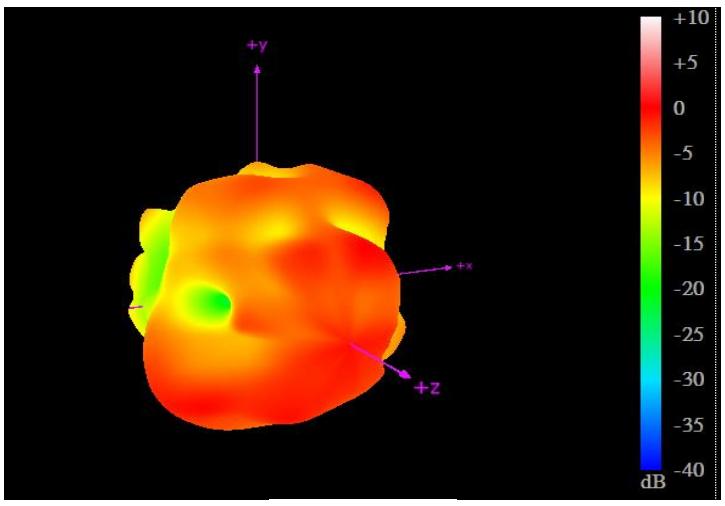

5550MHz

## 4. Mechanical Drawing (unit:mm)

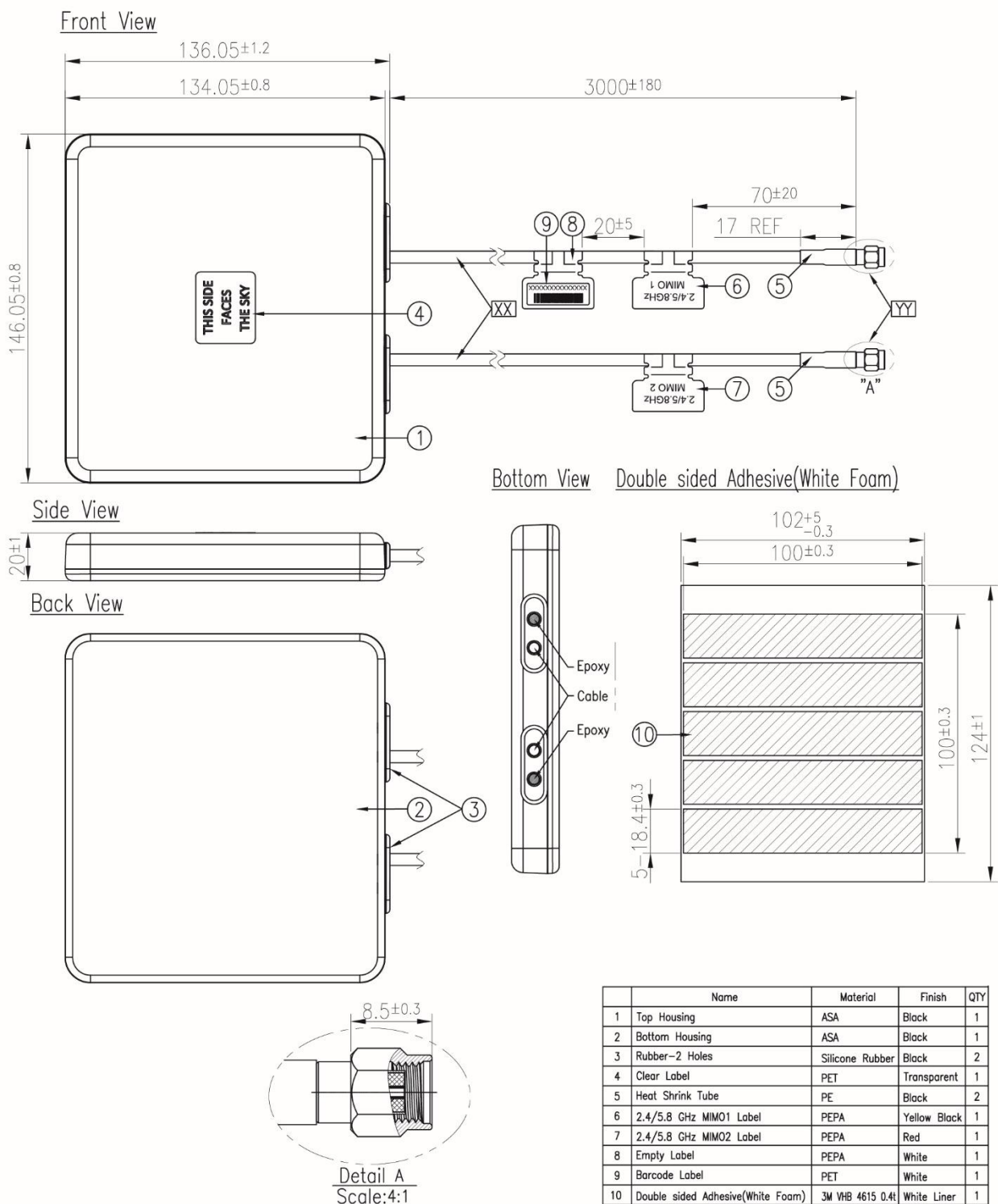

	Name	Material	Finish	QTY
1	Top Housing	ASA	Black	1
2	Bottom Housing	ASA	Black	1
3	Rubber-2 Holes	Silicone Rubber	Black	2
4	Clear Label	PET	Transparent	1
5	Heat Shrink Tube	PE	Black	2
6	2.4/5.8 GHz MIMO1 Label	PEPA	Yellow Black	1
7	2.4/5.8 GHz MIMO2 Label	PEPA	Red	1
8	Empty Label	PEPA	White	1
9	Barcode Label	PET	White	1
10	Double sided Adhesive(White Foam)	3M VHB 4615 0.4t	White Liner	1

	Name	Material	Finish	QTY
XX	Cable Type	CFD200	Black	2
YY	Connector Type	RP-SMA(M)ST	Au Plated	2

# 5. Packaging

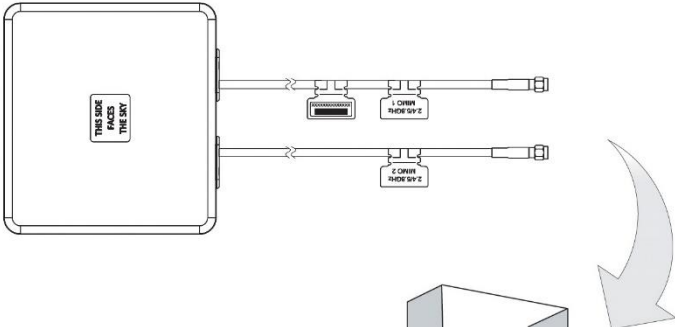

1 No. MA910.A.CG.001 per small box  
 Box Dimensions - 260 x 235 x 105mm  
 Weight - 0.75Kg

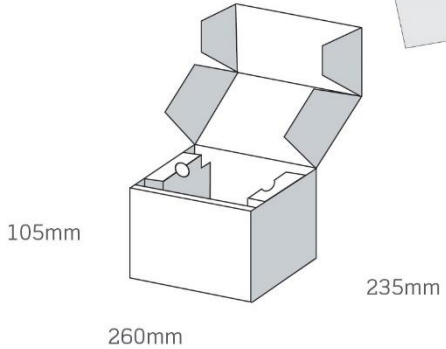

8 pcs MA910.A.CG.001 per carton  
 Carton Dimensions - 540 x 490 x 240mm  
 Weight - 6.6Kg

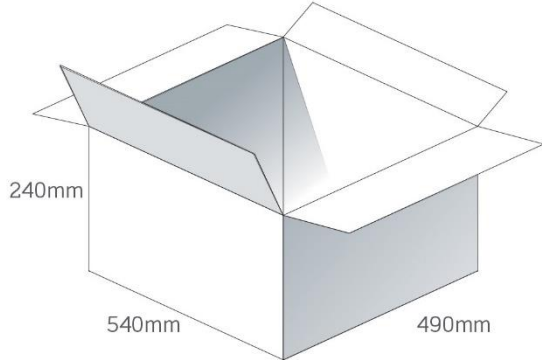

Pallet Dimensions 1200\*1000\*1400mm  
 20 Cartons per Pallet  
 4 Cartons per layer  
 5 Layers

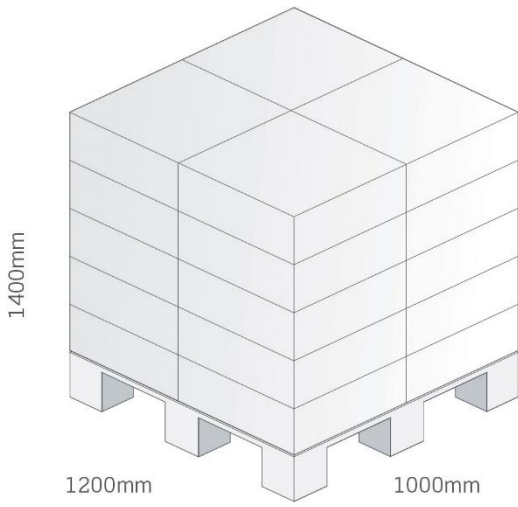

## 6. Application Note

The MA961 antenna performance with different cable lengths is shown below.

### 6.1 In free space (Wi-Fi)

#### 6.1.1 Return Loss (WI-FI\_MIMO 1)

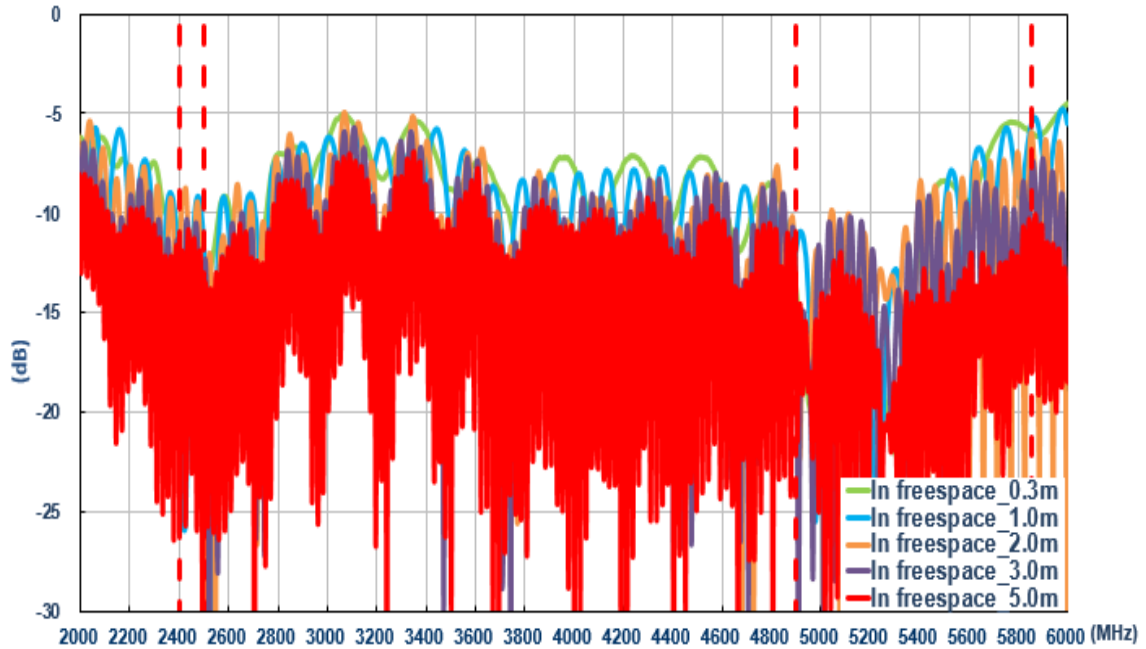

#### 6.1.2 Return Loss (Wi-Fi\_MIMO 2)

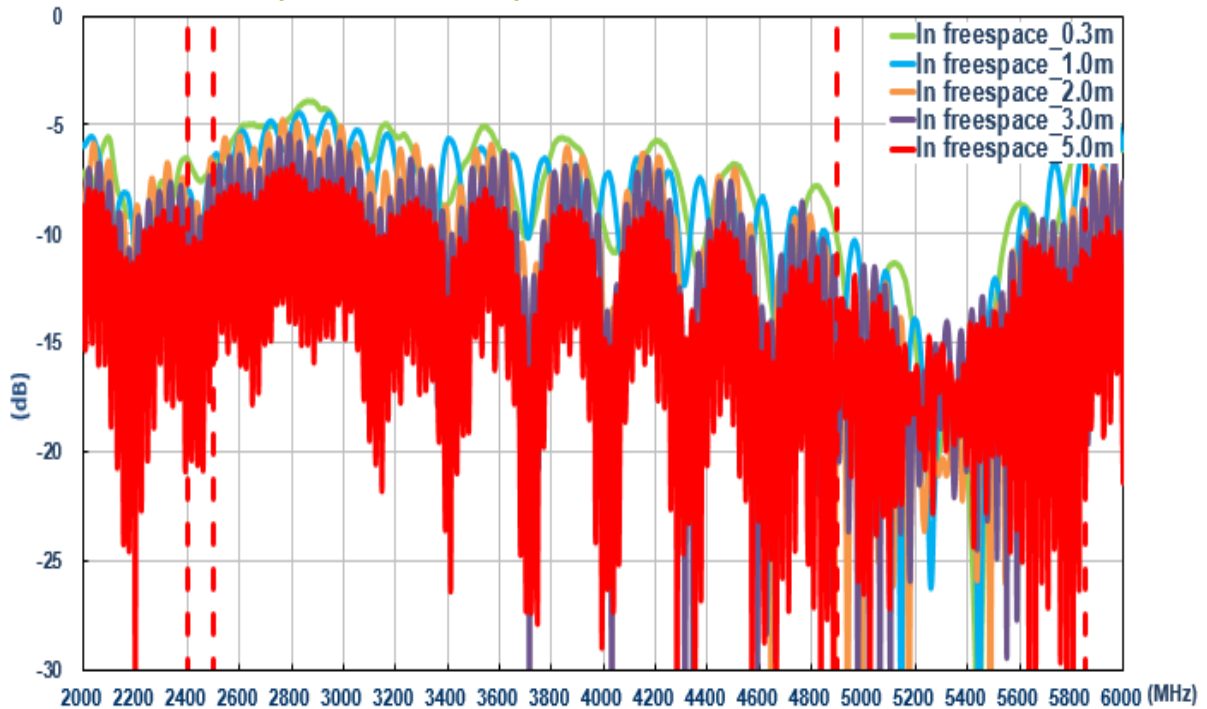

### 6.1.3 Isolation (Wi-Fi)

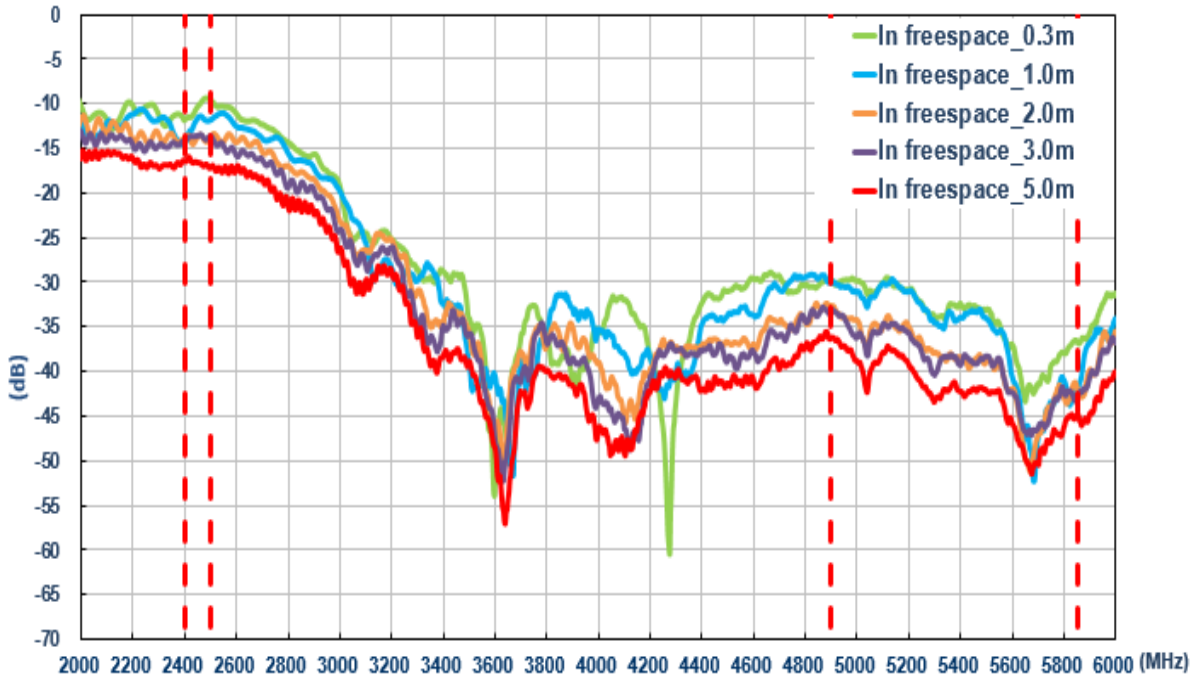

### 6.1.4 Efficiency (MIMO 1)

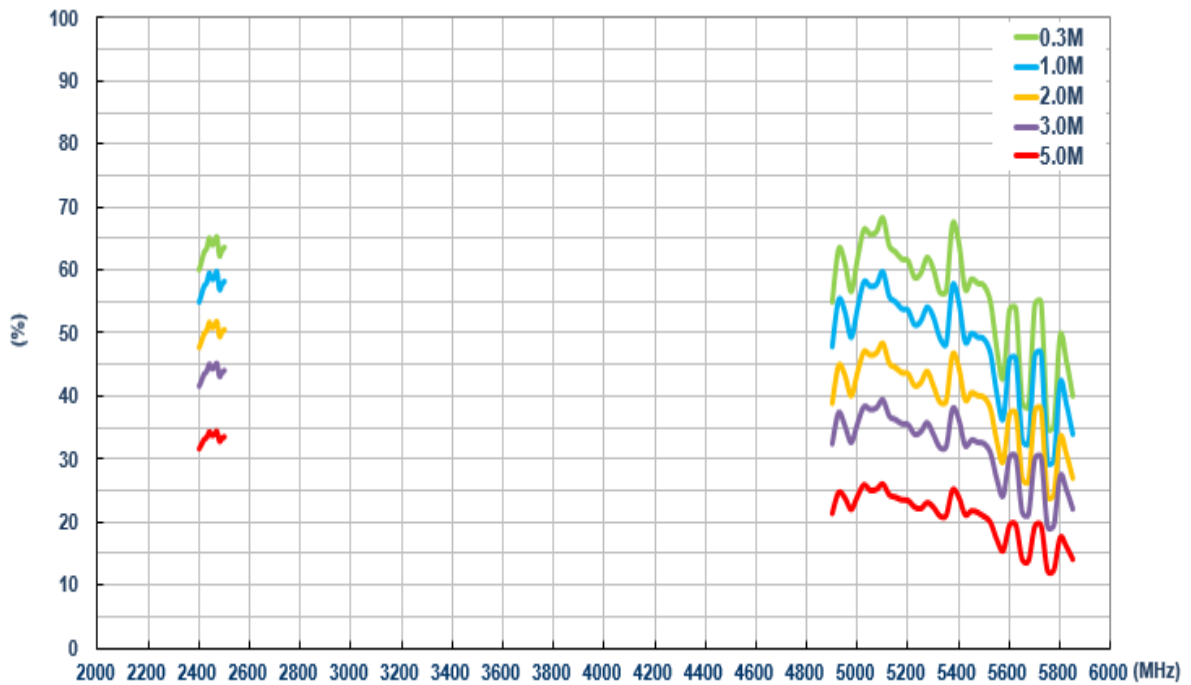

### 6.1.5 Efficiency (MIMO 2)

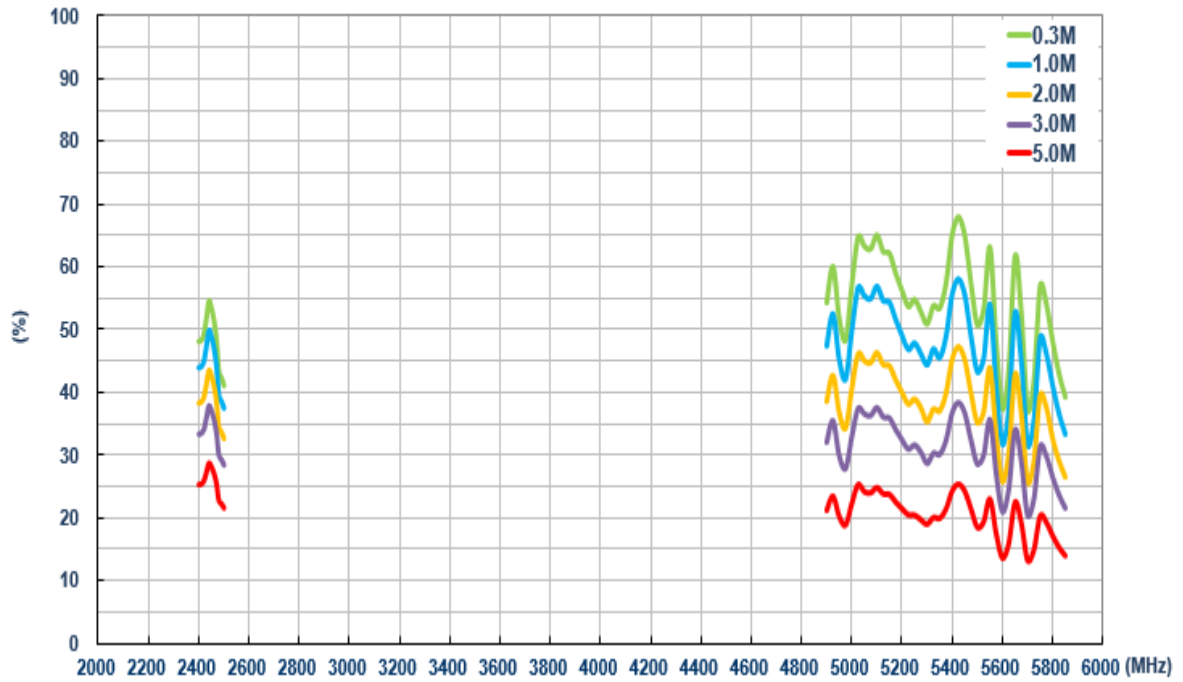

### 6.1.6 Average Gain (MIMO 1)

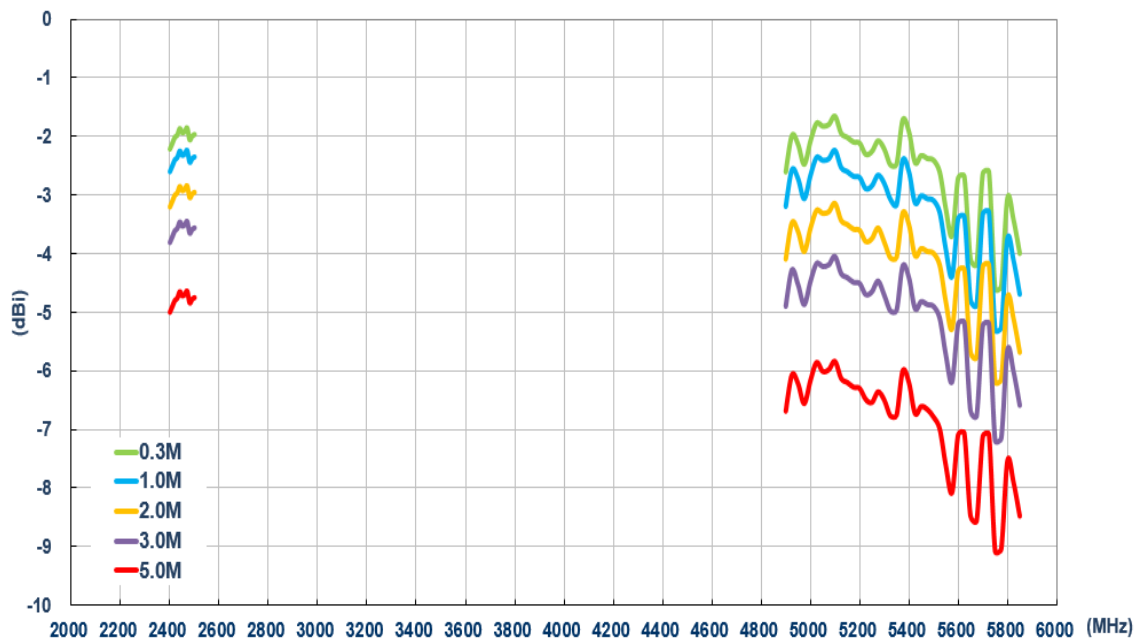



### 6.1.7 Average Gain (MIMO 2)

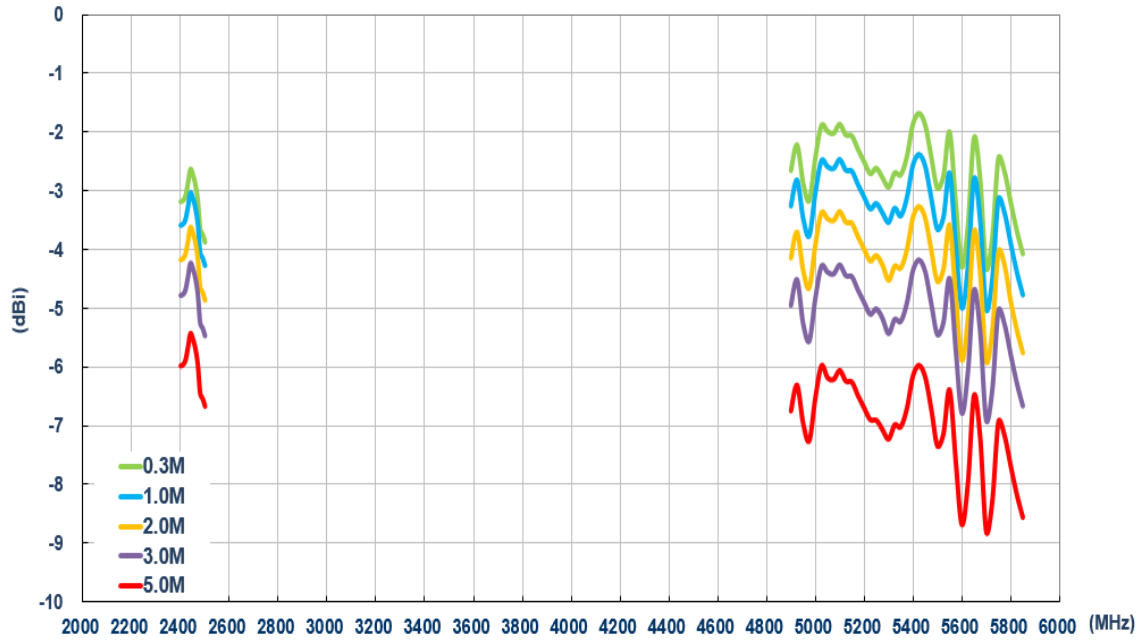

### 6.1.8 Peak Gain (MIMO 1)

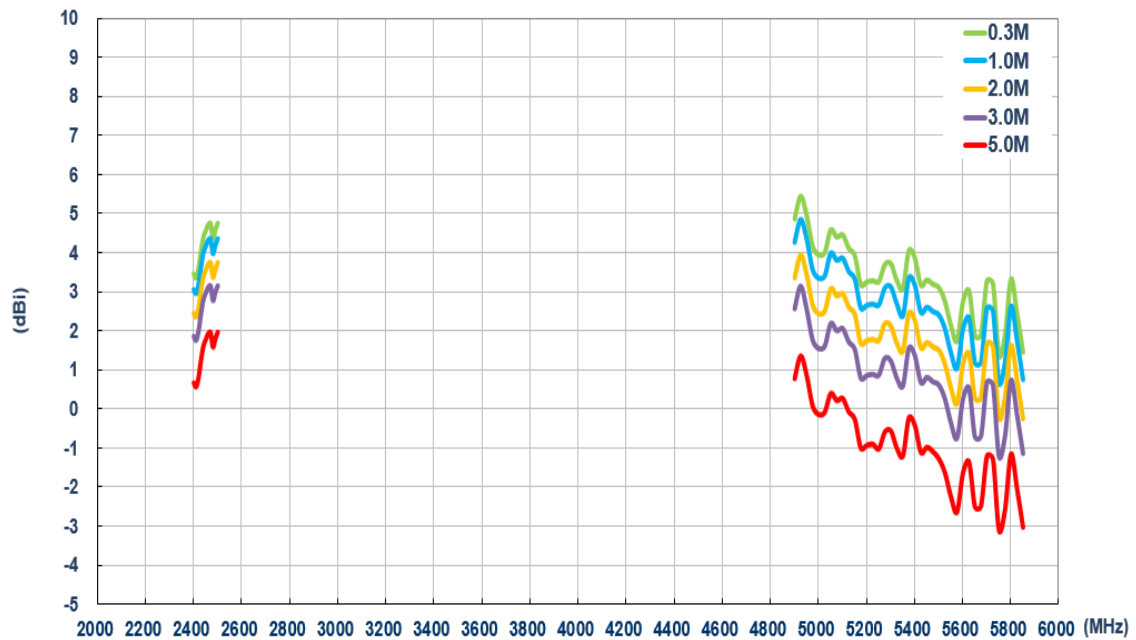

### 6.1.9 Peak Gain (MIMO 2)

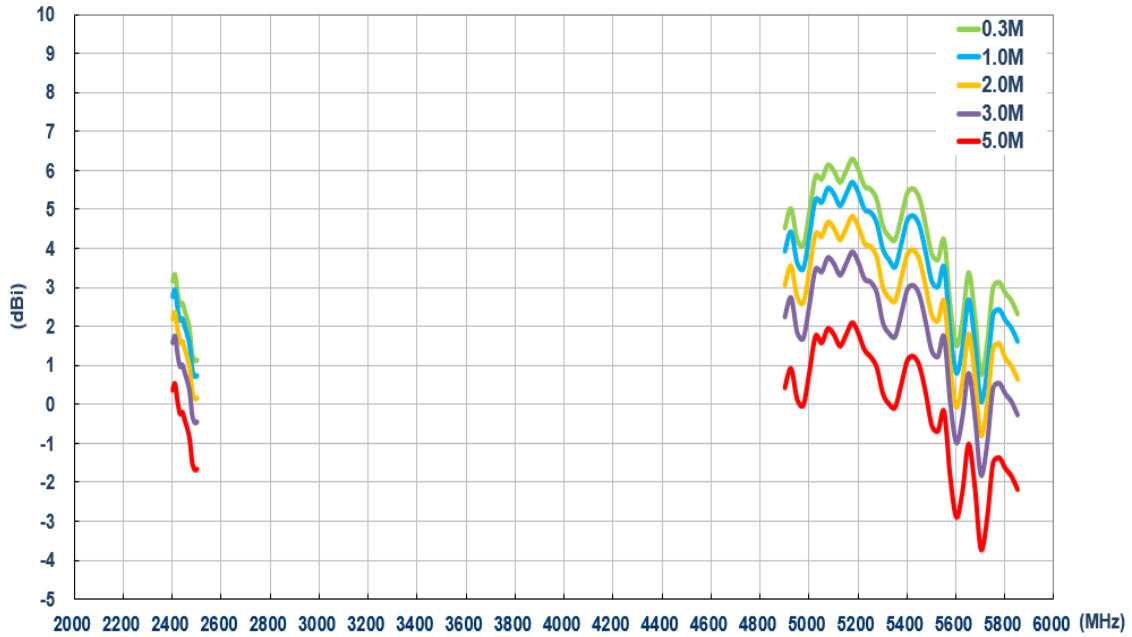

## 6.2 On the ABS (Wi-Fi)

### 6.2.1 Return Loss (Wi-Fi MIMO 1)

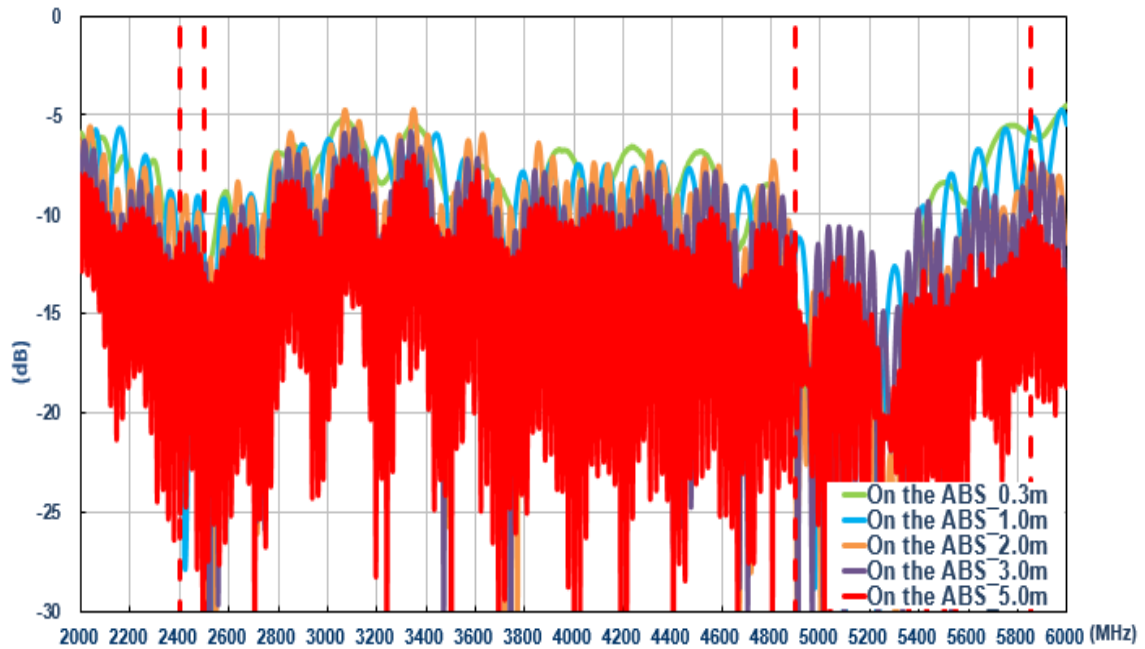

6.2.2 Return Loss (Wi-Fi MIMO 2)

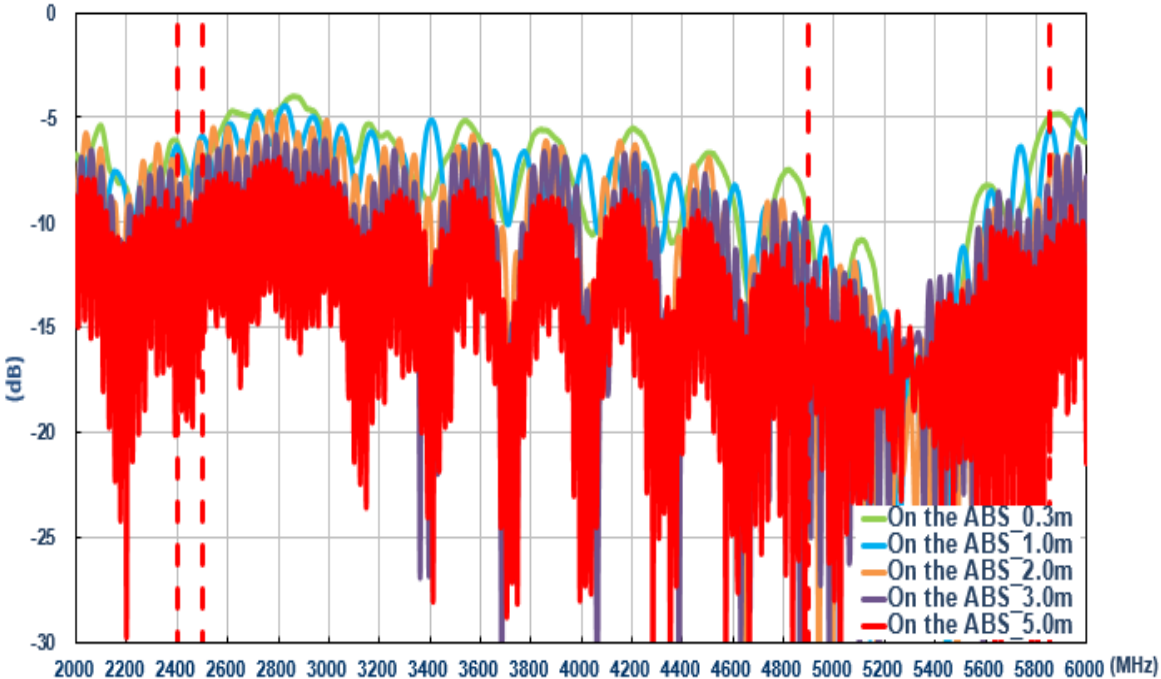

6.2.3 Isolation (Wi-Fi)

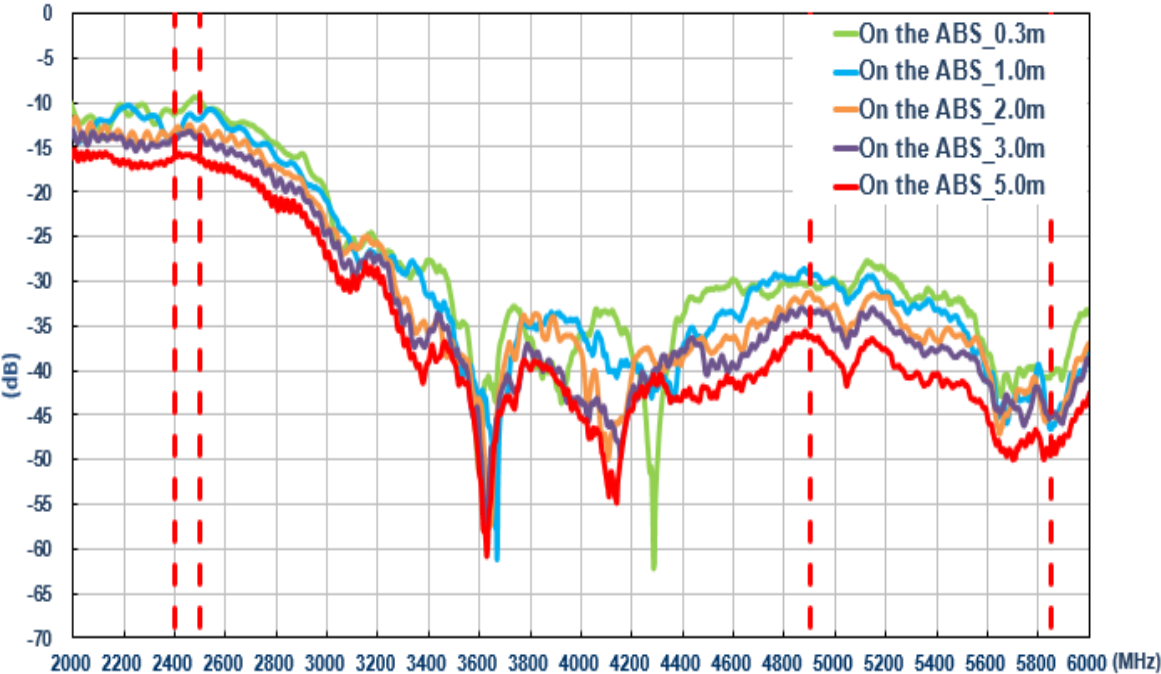

### 6.2.4 Efficiency (MIMO 1)

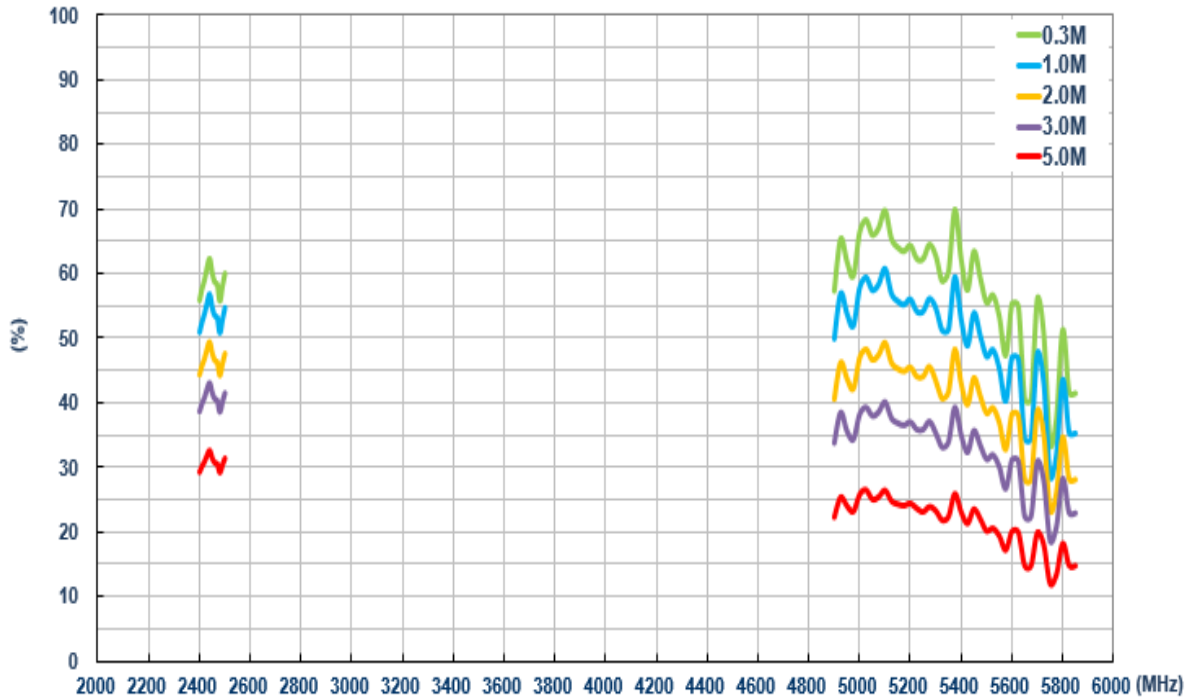

### 6.2.5 Efficiency (MIMO 2)

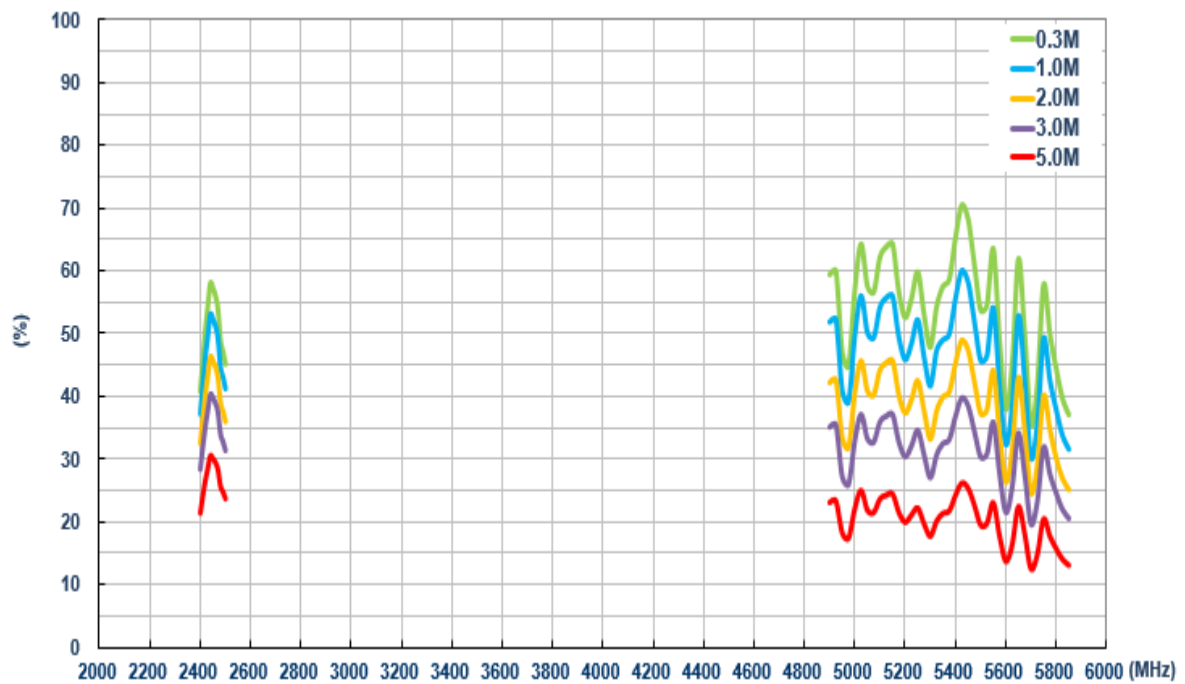

6.2.6 Average Gain (MIMO 1)

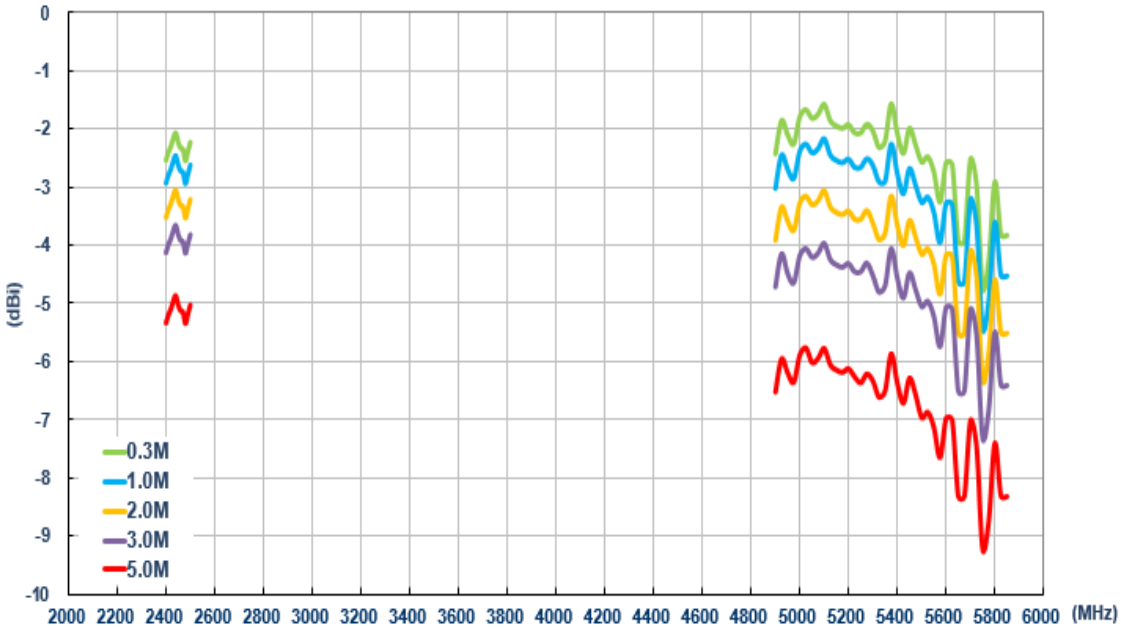

6.2.7 Average Gain (MIMO 2)

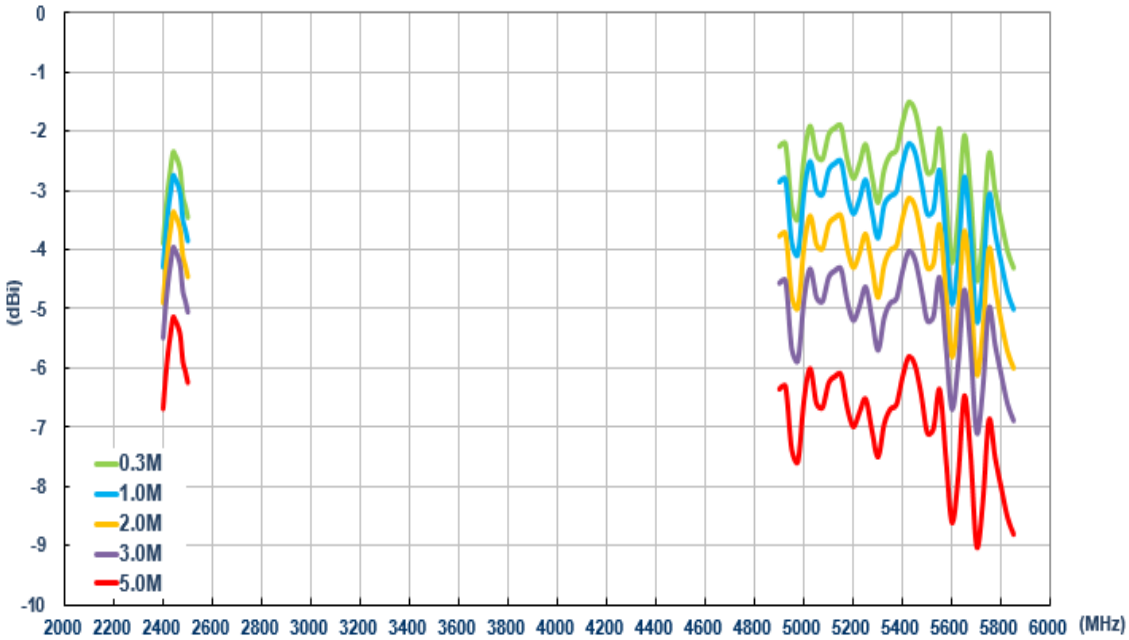

### 6.2.8 Peak Gain (MIMO 1)

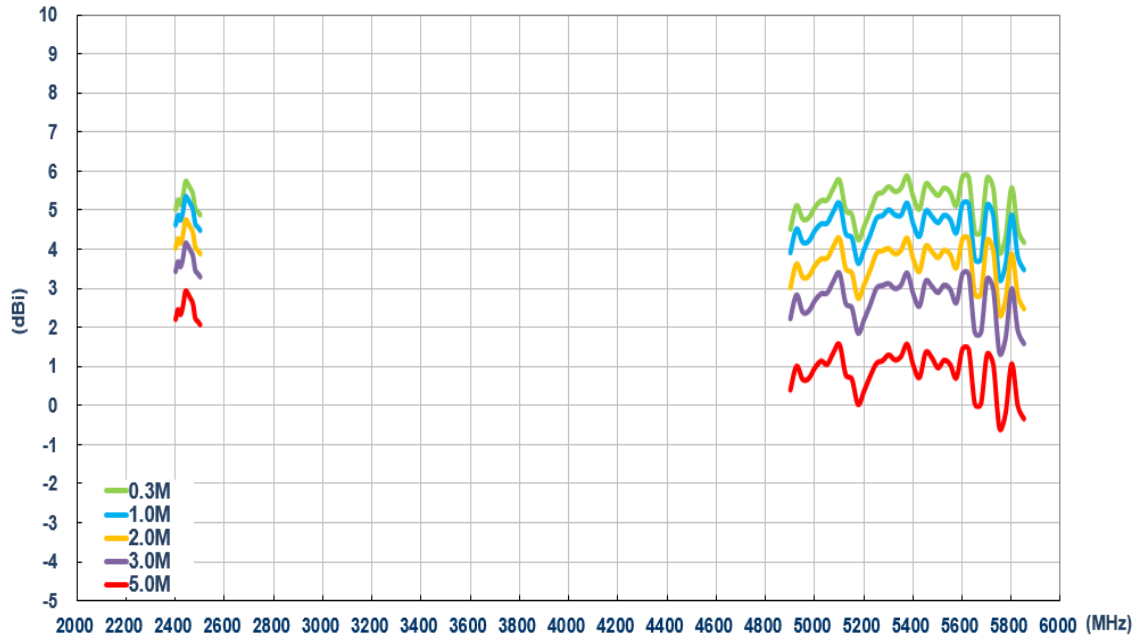

### 6.2.9 Peak Gain (MIMO 2)

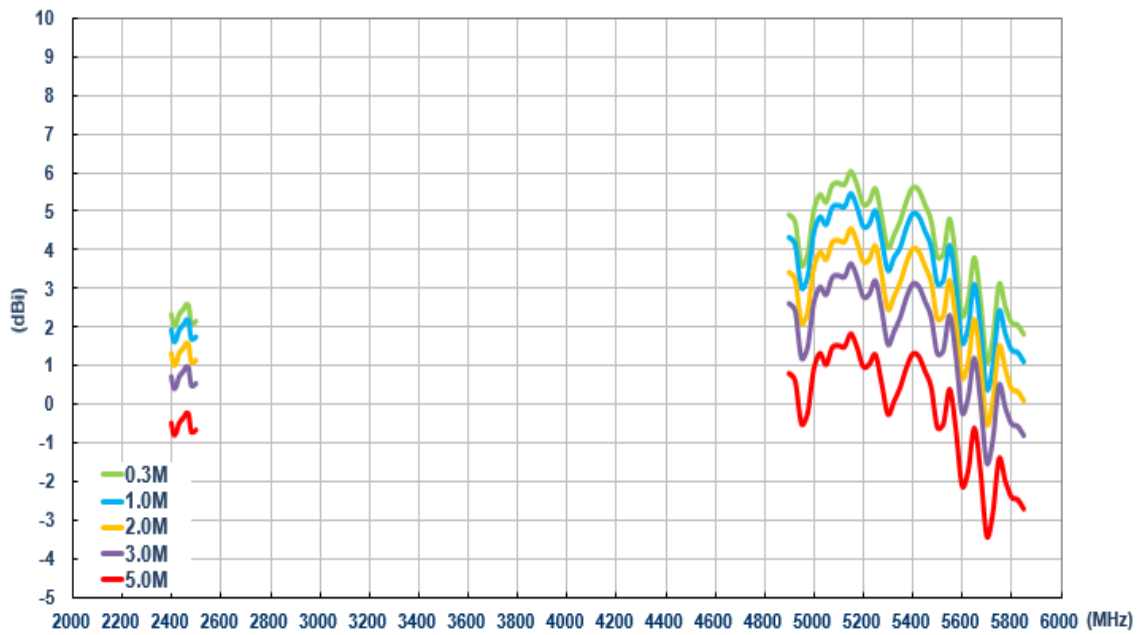

### 6.3 On the glass (Wi-Fi)

#### 6.35.1 Return Loss (Wi-Fi MIMO 1)

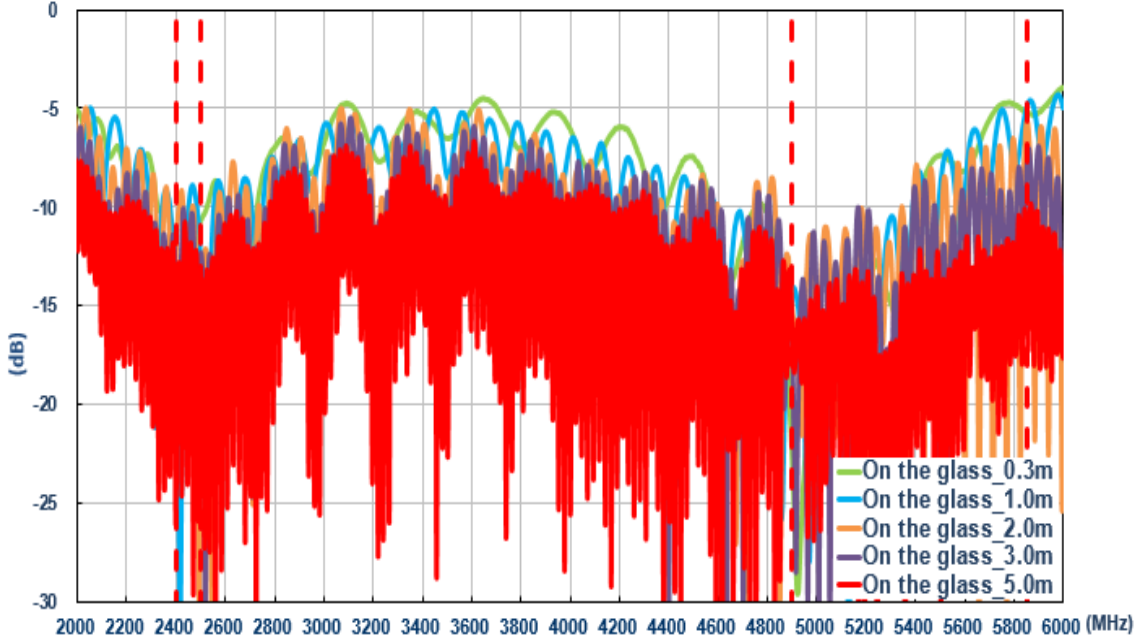

#### 6.35.2 Return Loss (Wi-Fi MIMO 2)

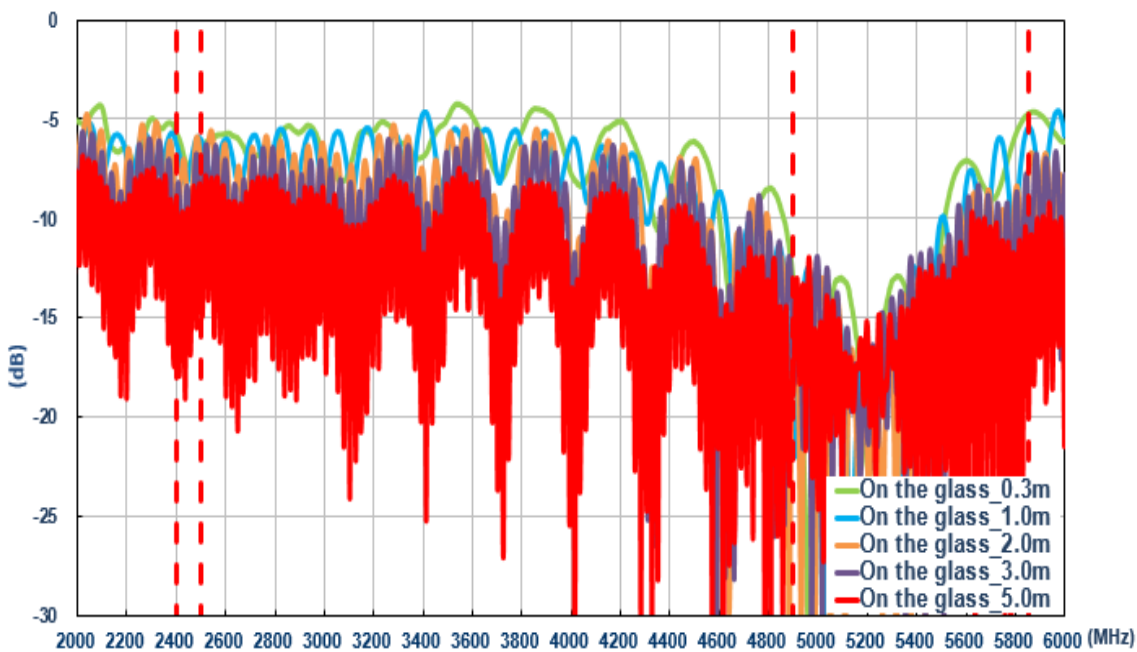

### 6.3.3 Isolation (Wi-Fi)

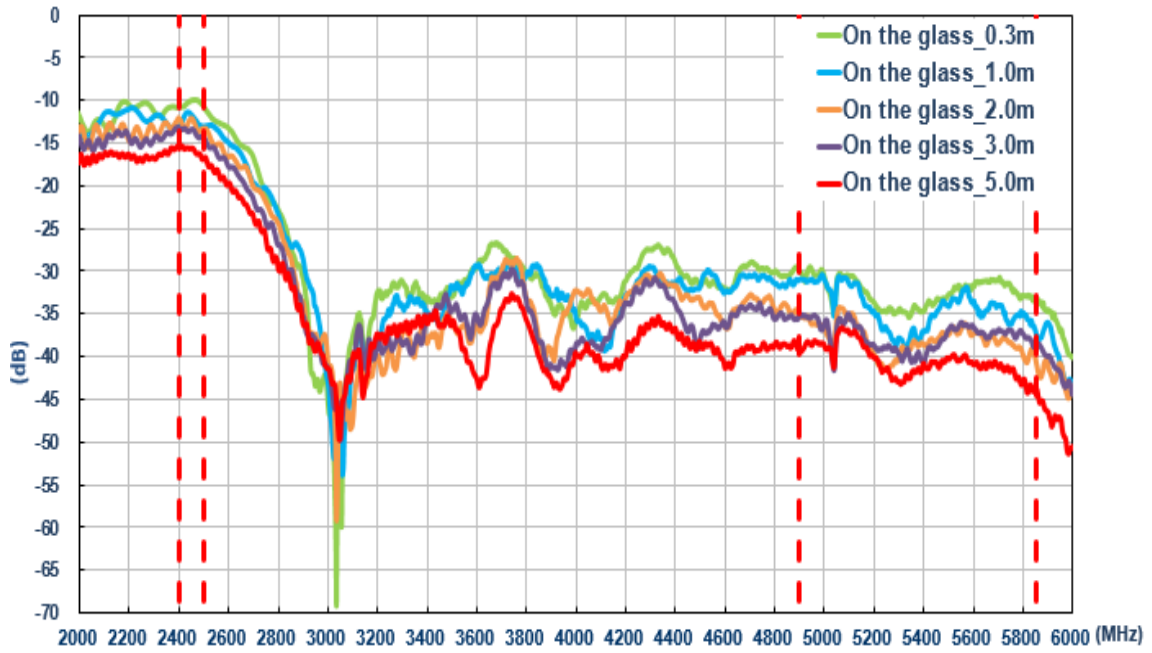

### 6.3.4 Efficiency (Wi-Fi MIMO 1)

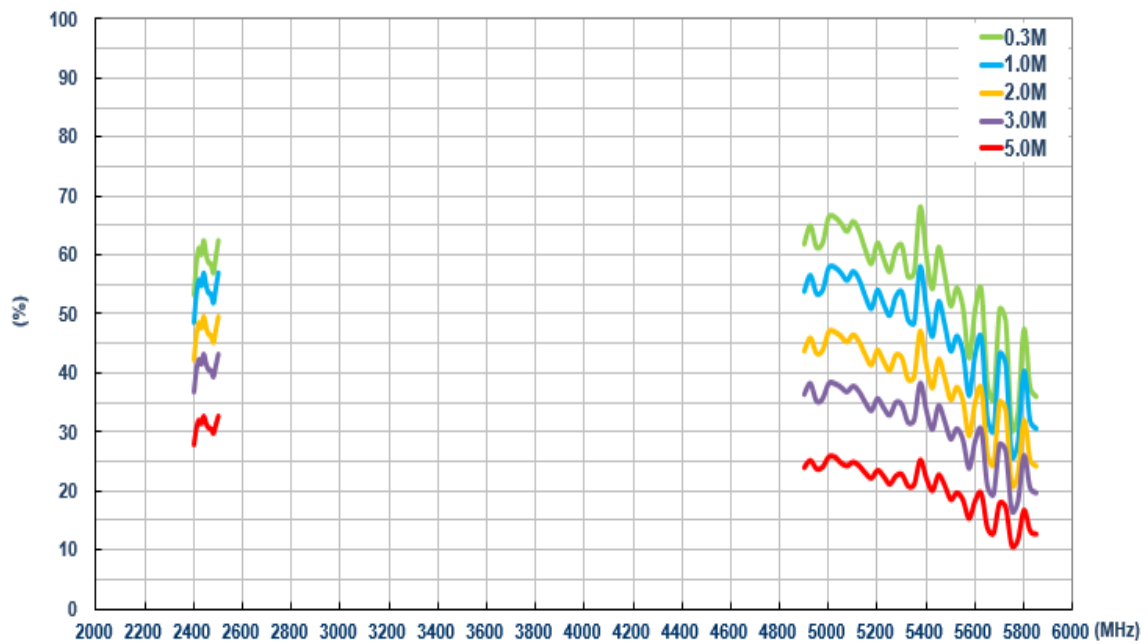



### 6.3.5 Efficiency (Wi-Fi MIMO 2)

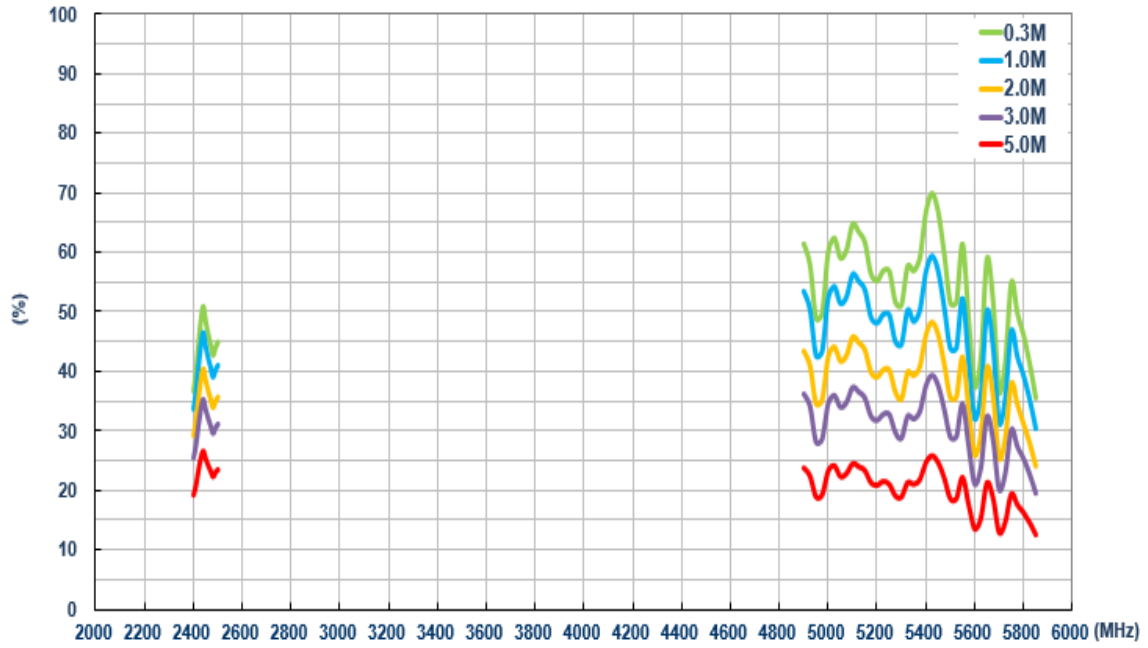

### 6.3.6 Average Gain (Wi-Fi MIMO 1)

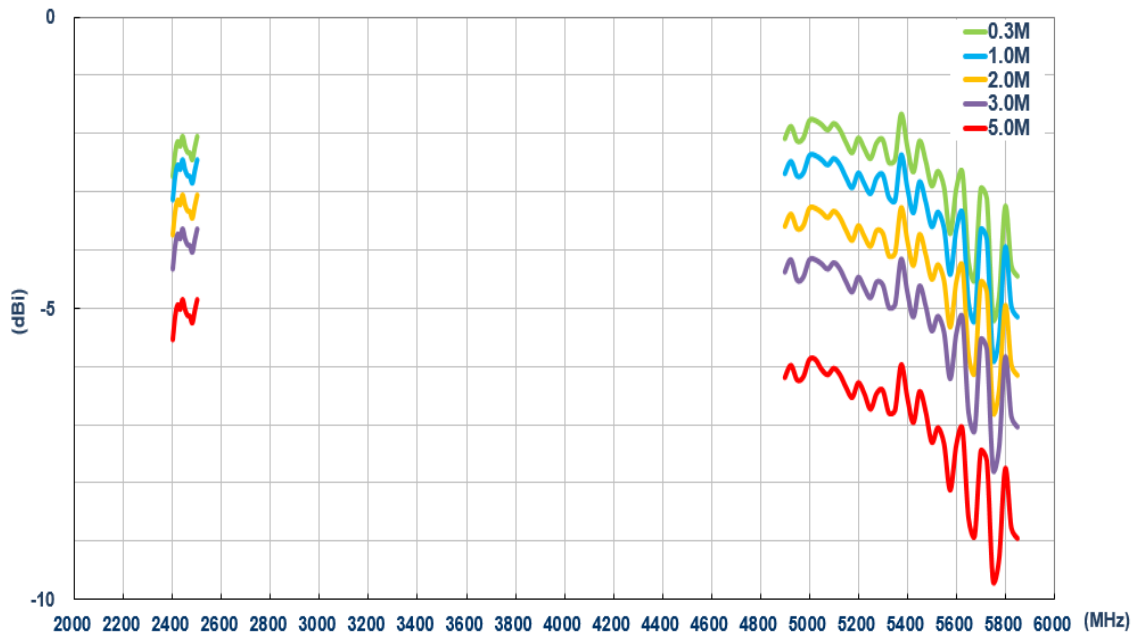

### 6.3.7 Average Gain (Wi-Fi MIMO 2)

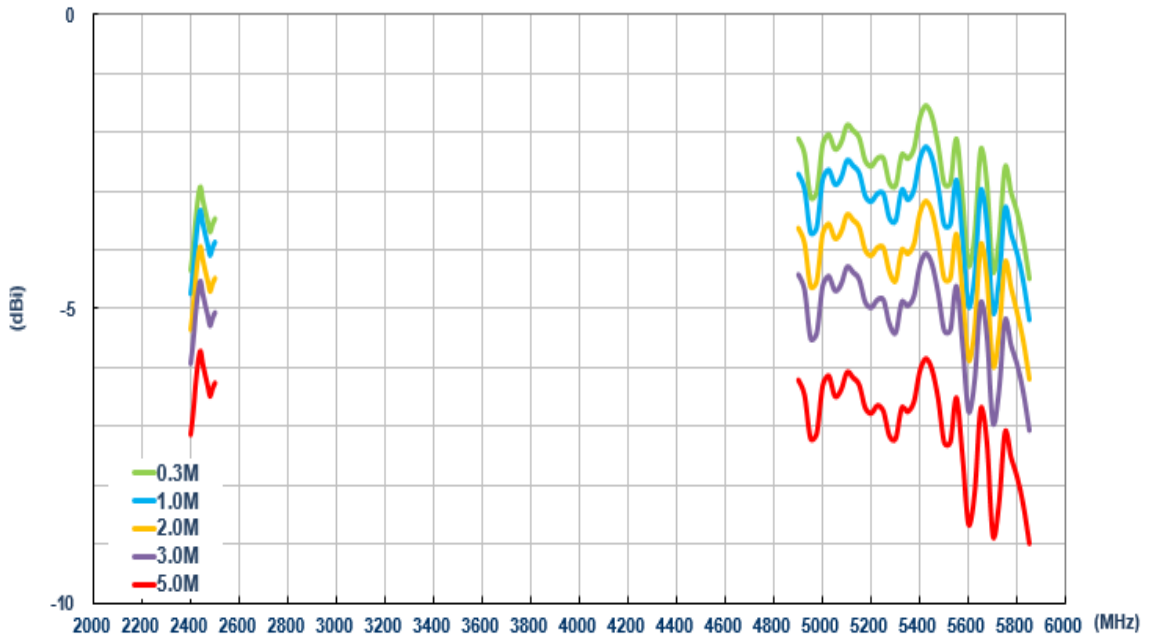

### 6.3.8 Peak Gain (Wi-Fi MIMO 1)

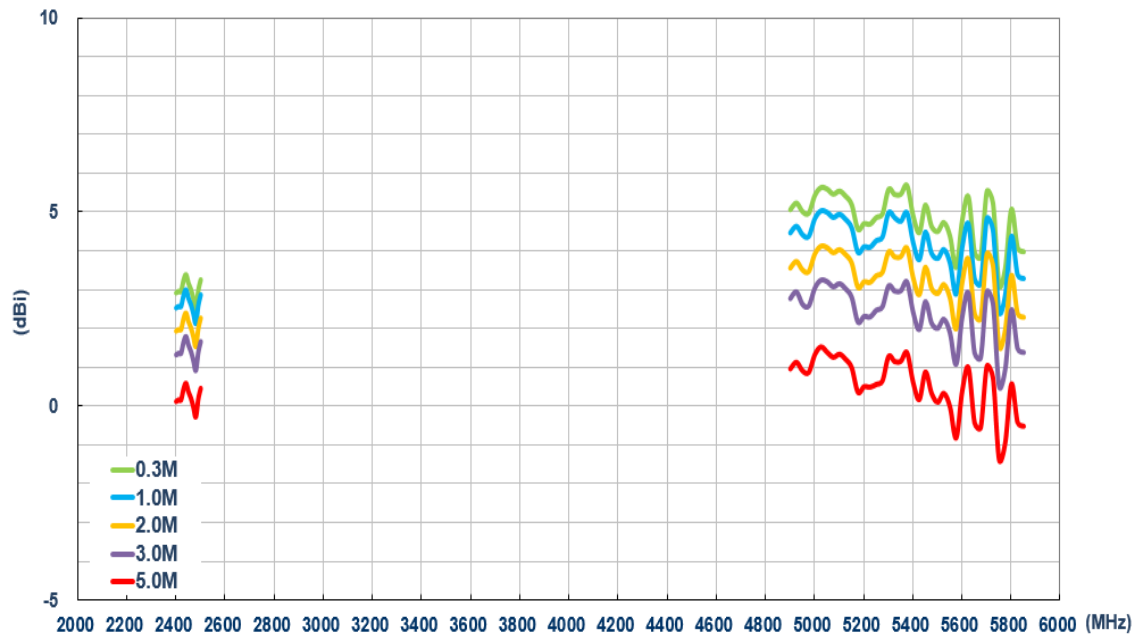

6.3.9 Peak Gain (Wi-Fi MIMO 2)

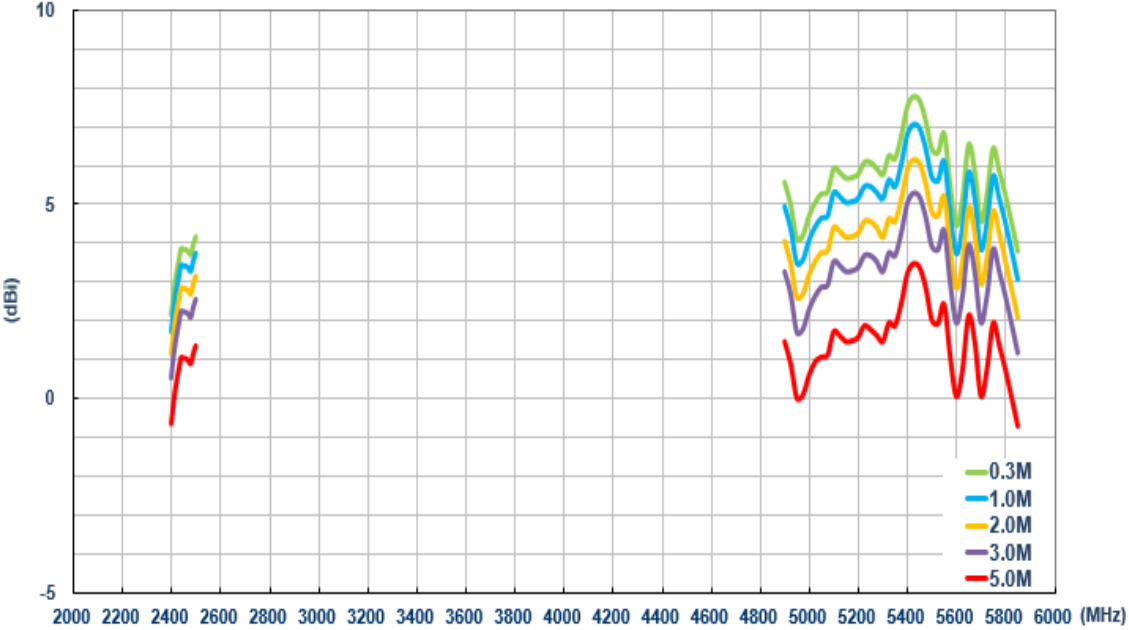

6.4 On the metal (Wi-Fi)

6.4.1 Return Loss (Wi-Fi MIMO 1)

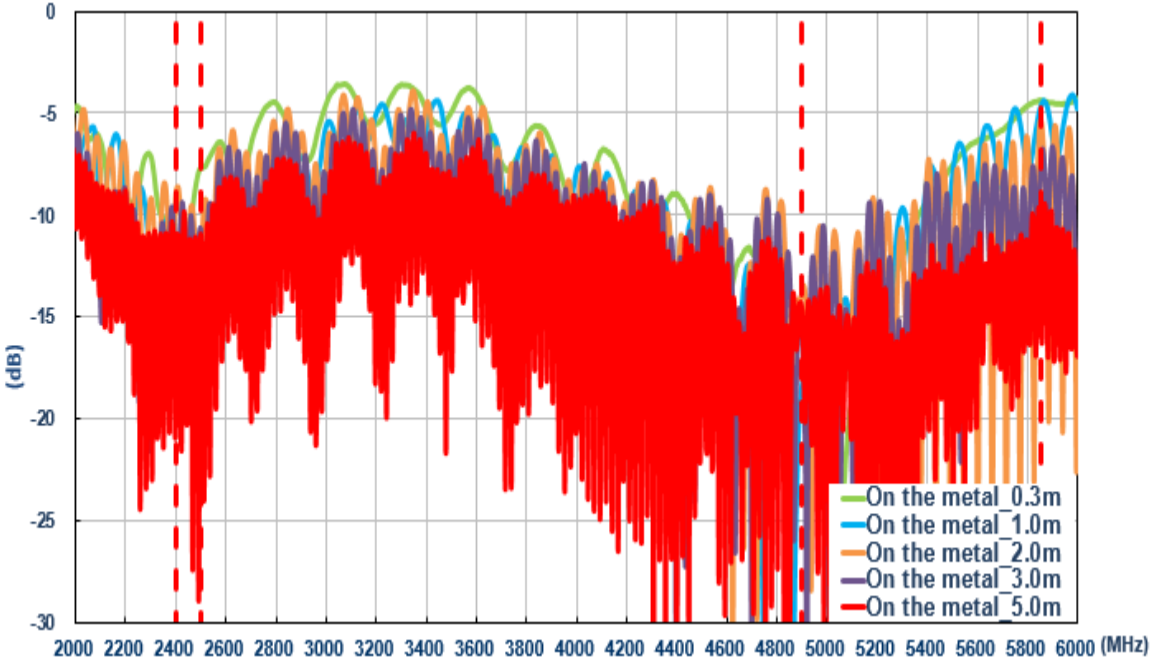

6.4.2 Return Loss (Wi-Fi MIMO 2)

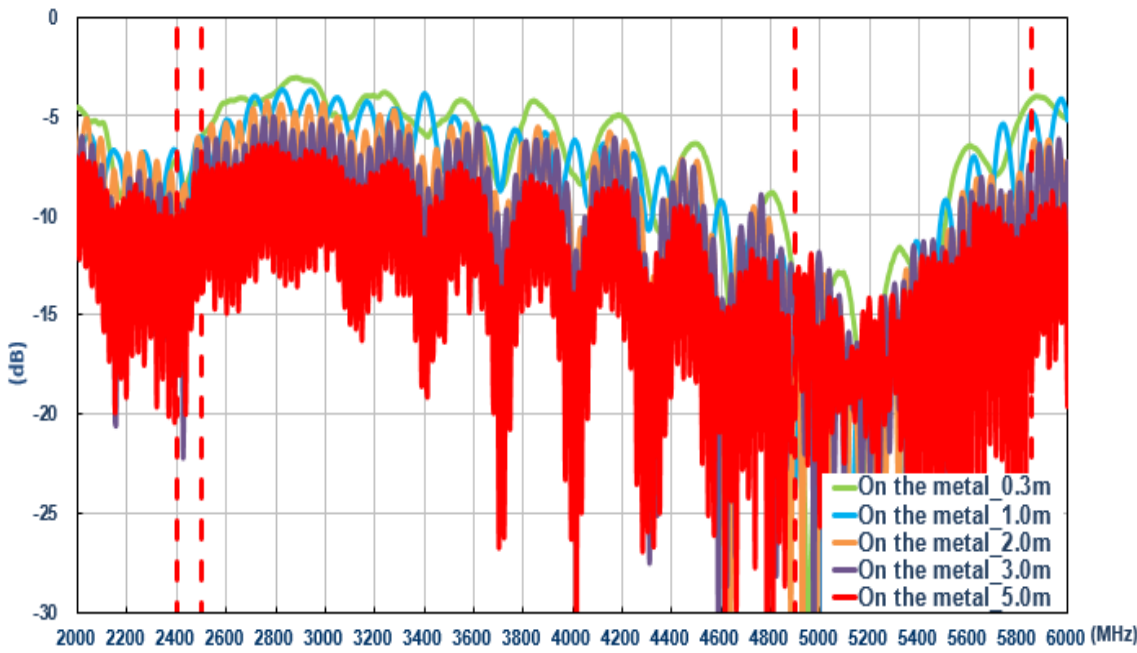

6.4.3 Isolation (Wi-Fi)

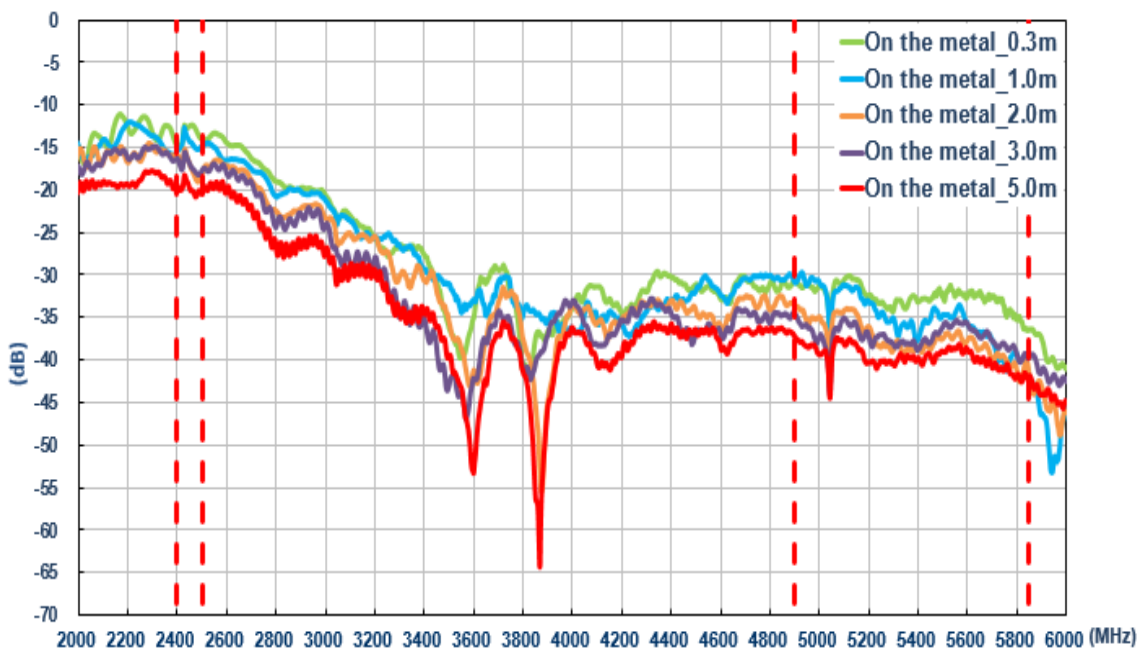

6.4.4 Efficiency (Wi-Fi MIMO 1)

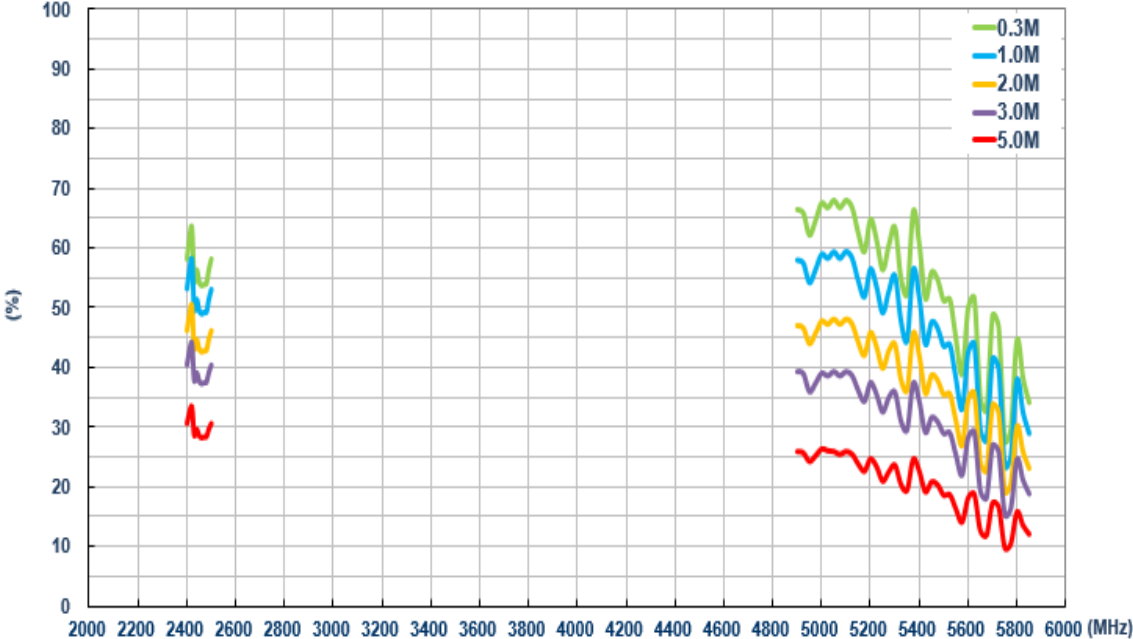

6.4.5 Efficiency (Wi-Fi MIMO 2)

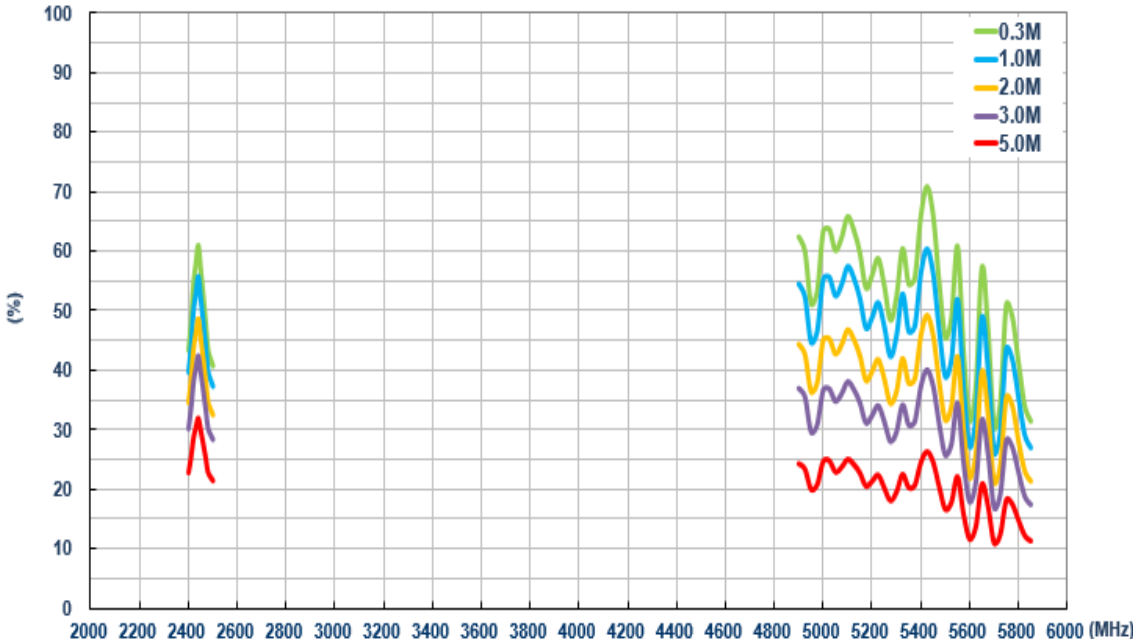

### 6.4.6 Average Gain (Wi-Fi MIMO 1)

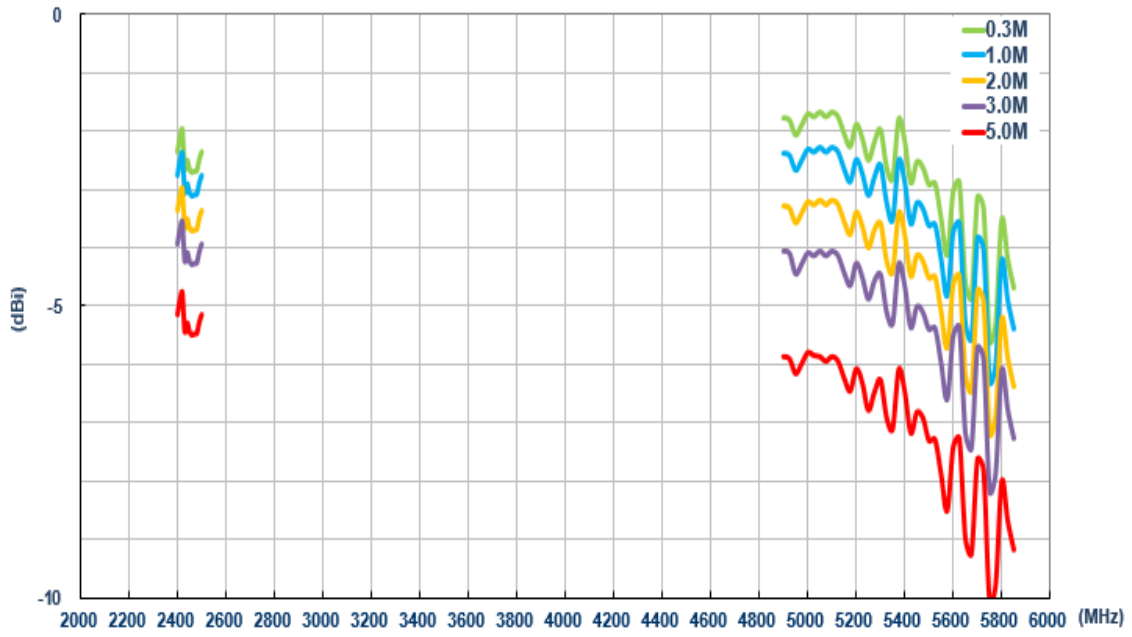

### 6.4.7 Average Gain (Wi-Fi MIMO 2)

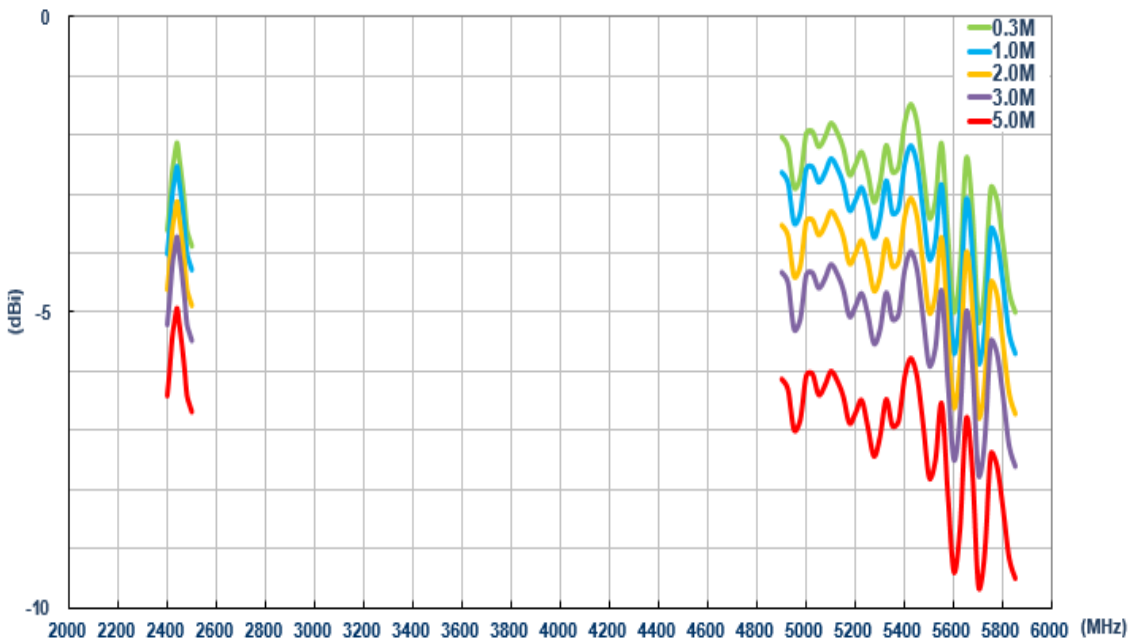

### 6.4.8 Peak Gain (Wi-Fi MIMO 1)

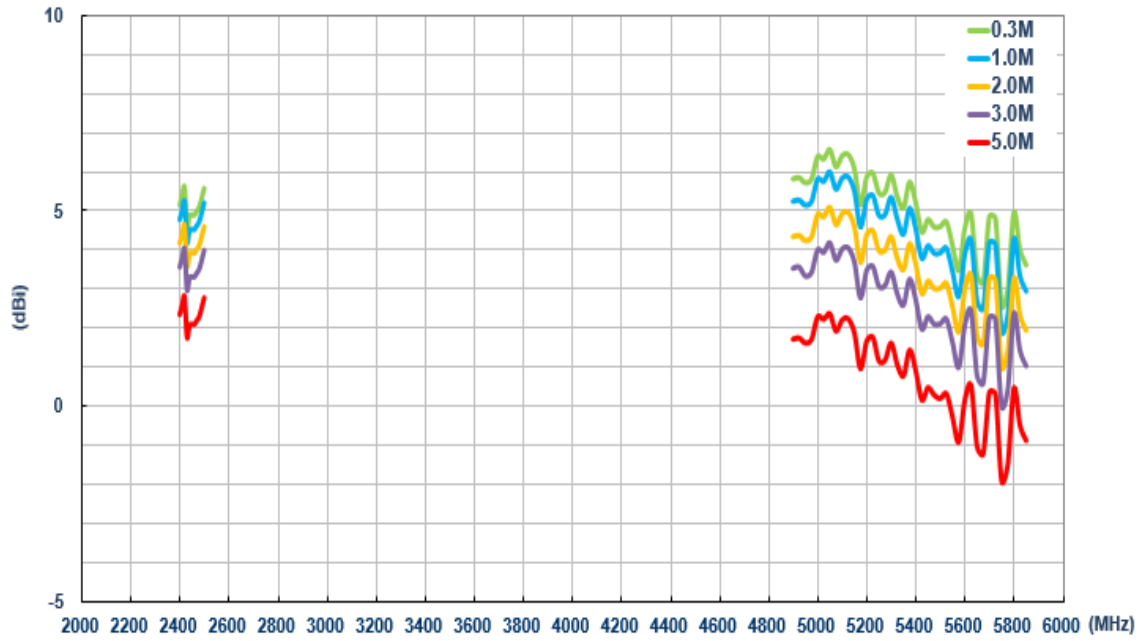

### 6.4.9 Peak Gain (Wi-Fi MIMO 2)

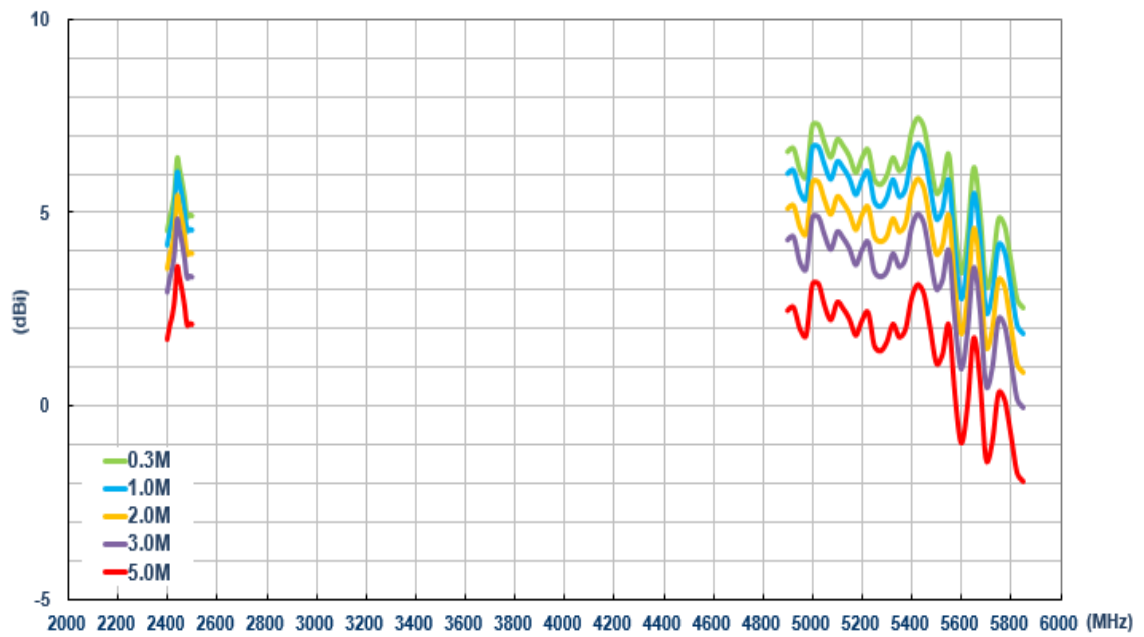

## 6.5 On the wall (Wi-Fi)

### 6.5.1 Return Loss (Wi-Fi MIMO 1)

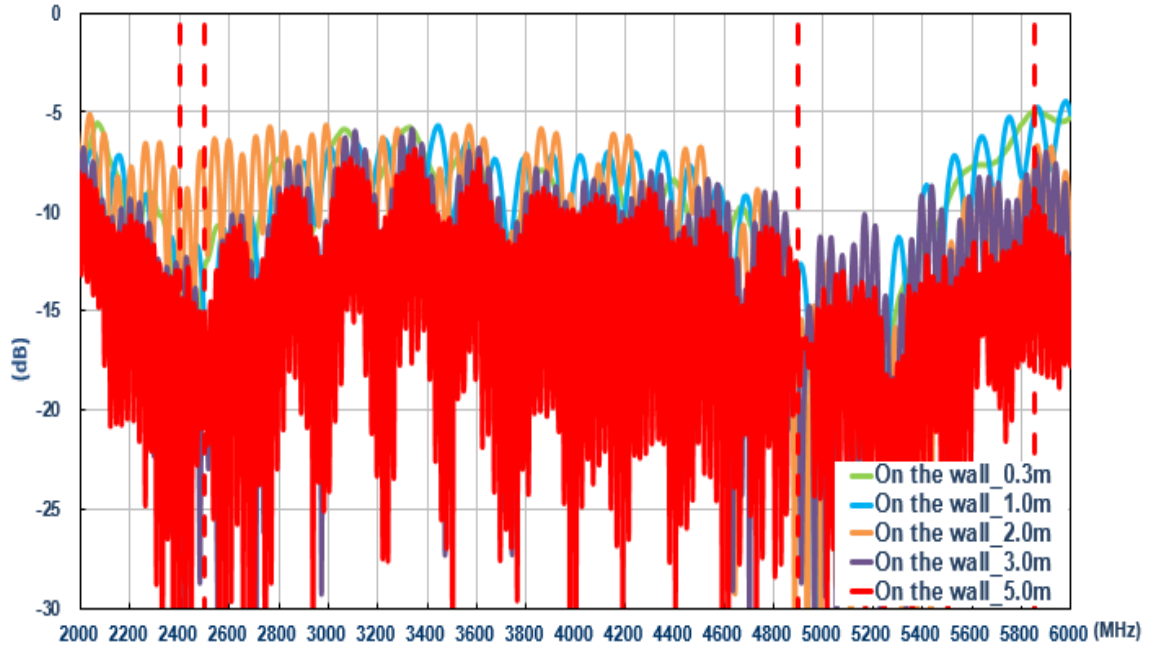

### 6.5.2 Return Loss (Wi-Fi MIMO 2)

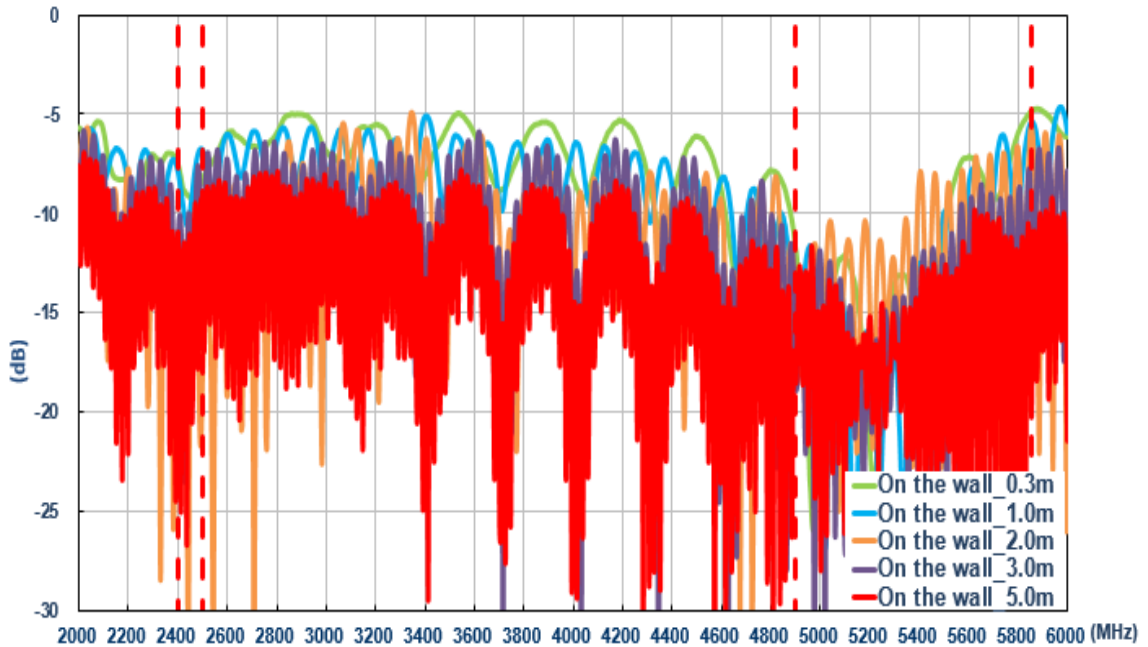



### 6.5.3 Isolation (Wi-Fi)

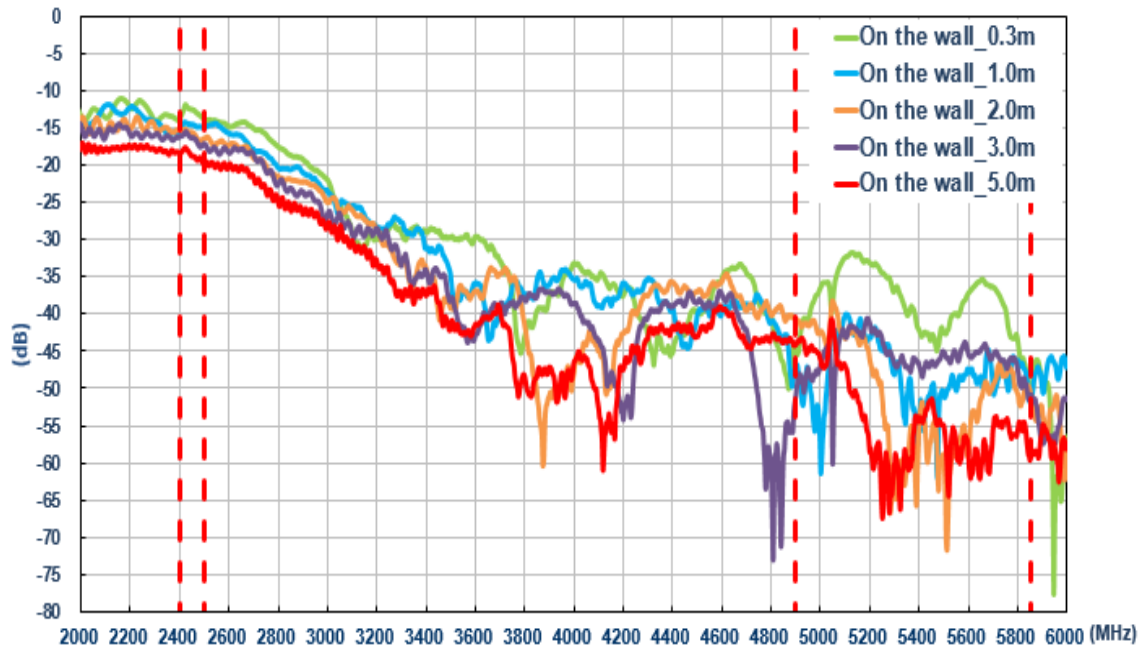

### 6.5.4 Efficiency (Wi-Fi MIMO 1)

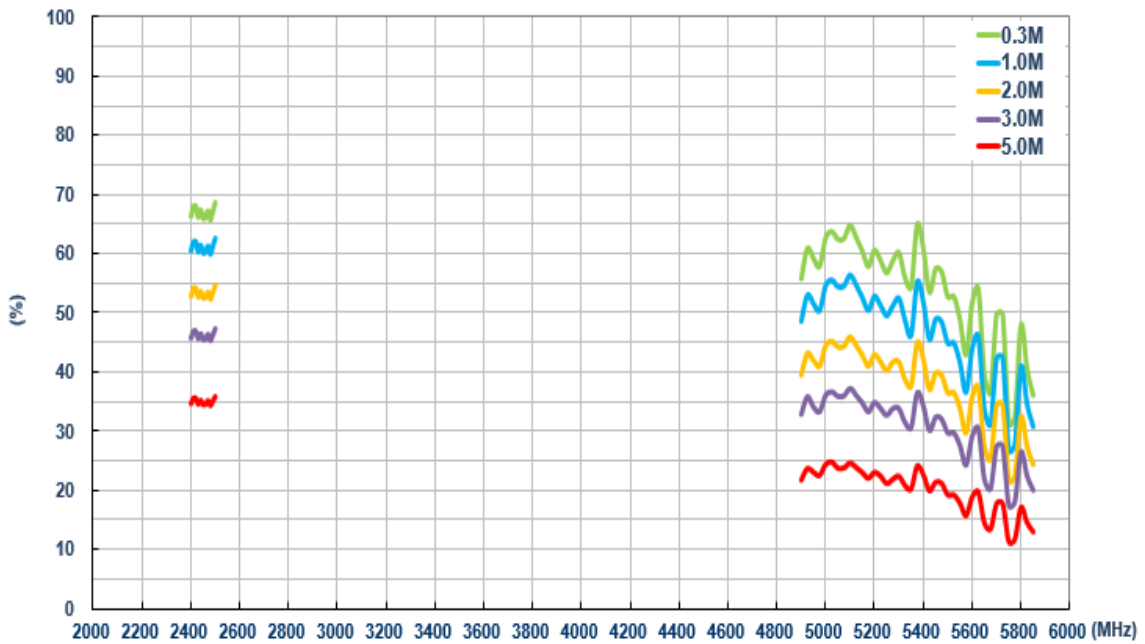

### 6.5.5 Efficiency (Wi-Fi MIMO 2)

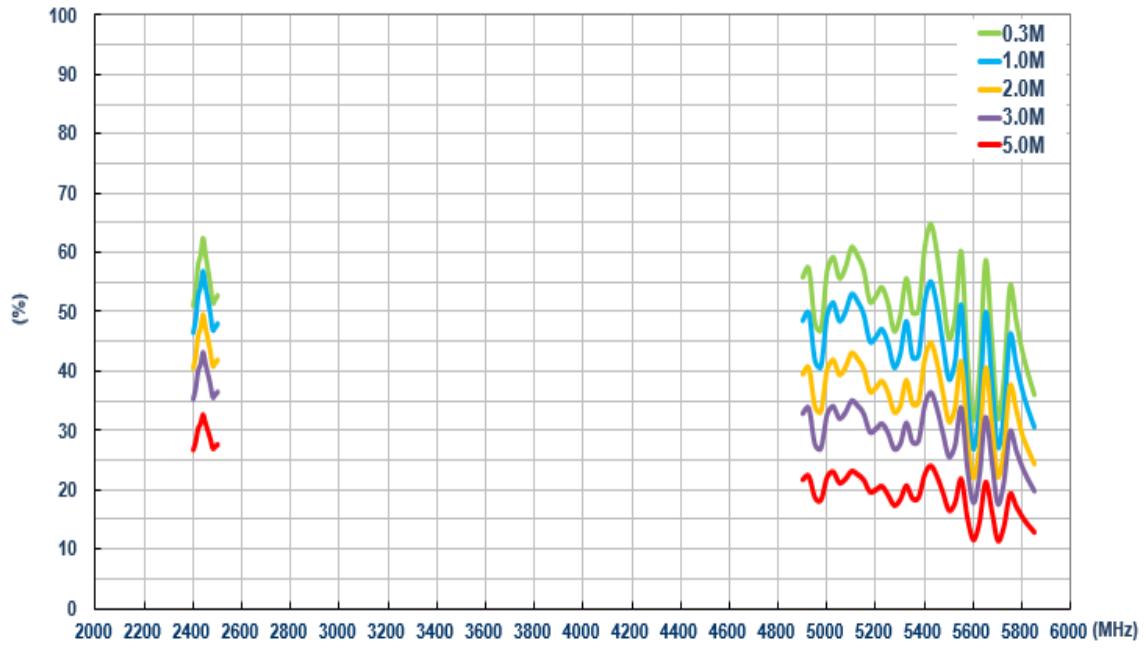

### 6.5.6 Average Gain (Wi-Fi MIMO 1)

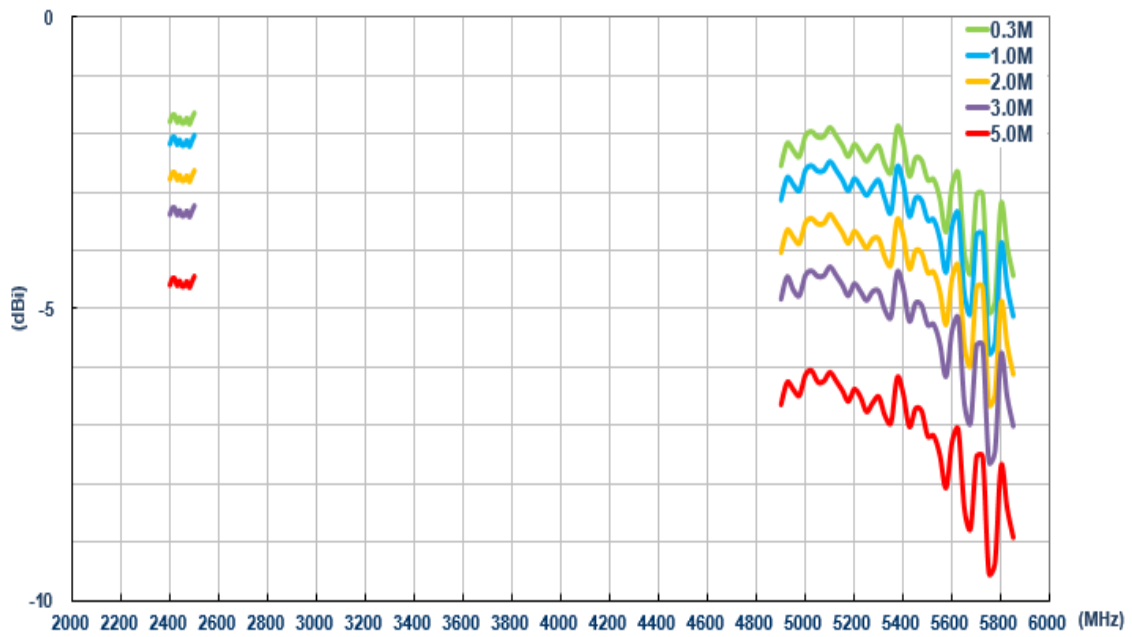

### 6.5.7 Average Gain (Wi-Fi MIMO 2)

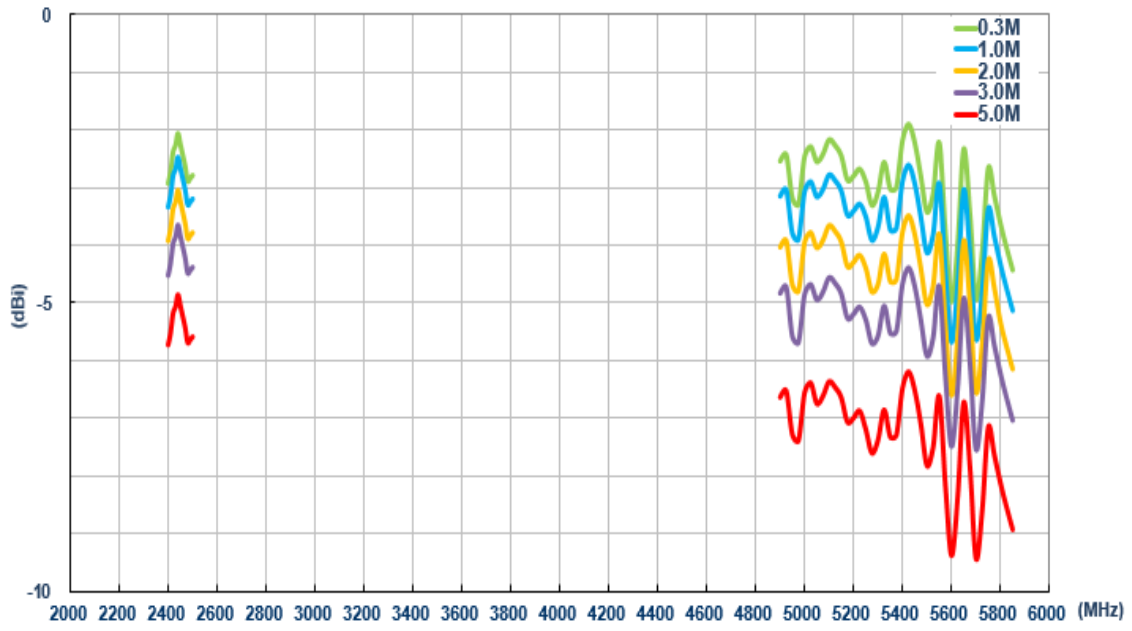

### 6.5.8 Peak Gain (Wi-Fi MIMO 1)

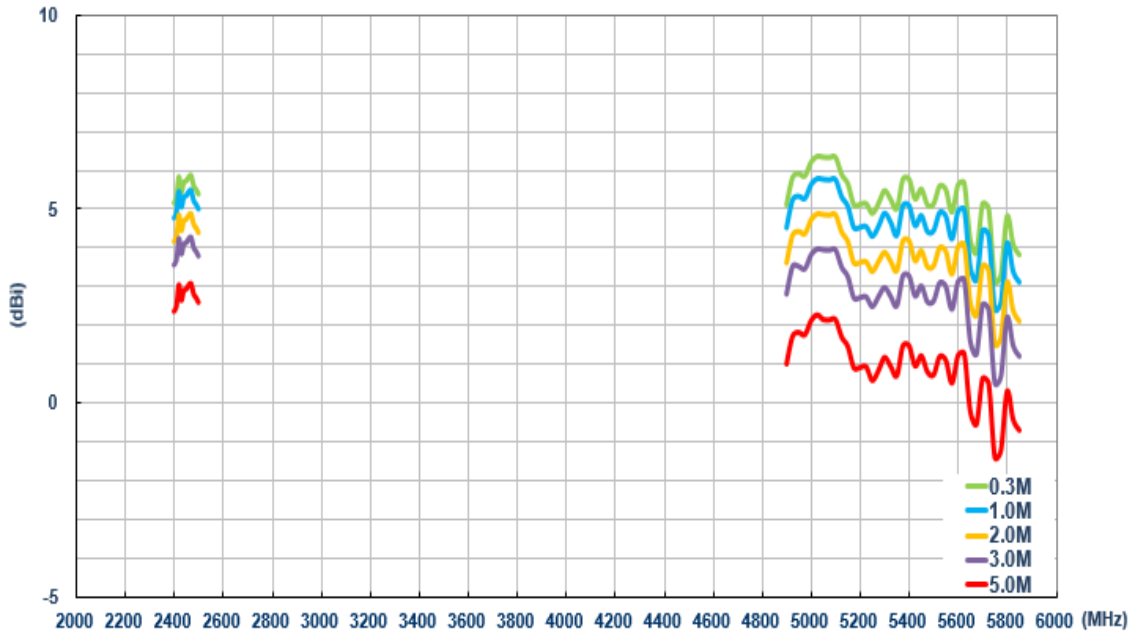

6.5.9 Peak Gain (Wi-Fi MIMO 2)

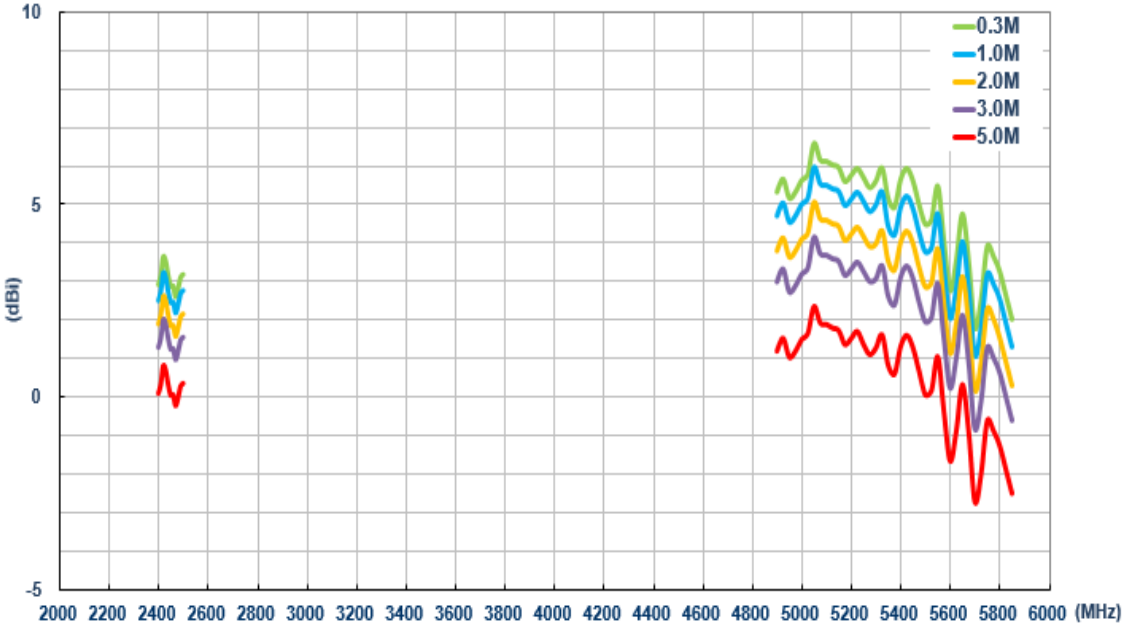

Taoglas makes no warranties based on the accuracy or completeness of the contents of this document and reserves the right to make changes to specifications and product descriptions at any time without notice. Taoglas reserves all rights to this document and the information contained herein.

Reproduction, use or disclosure to third parties without express permission is strictly prohibited.

Copyright © Taoglas Ltd.