

SPECIFICATION

Part No. : **MA710.W.A.ABI.001**

Product Name : White Pantheon Antenna 3in1 MA.710
Screw-Mount (Permanent Mount)
2 x 4G/3G/2G LTE MIMO Cellular Antenna
1 x GPS/GLONASS/GALILEO Antenna

Feature : 2 x Cellular 4G/3G/2G Antennas (MIMO)
LTE / HSPA / GSM / GPRS / CDMA / UMTS
698~960MHz / 1710~2170MHz / 2300~2700MHz /
2900-3500MHz
1 x GPS/GLONASS/GALILEO 1575.42/1602MHz Active
Antenna
IP67 Waterproof
High Efficiency / Peak Gain Outdoor Antenna
RoHS Compliant



1. Introduction

The MA710 Pantheon antenna is an omnidirectional heavy-duty, fully IP67 waterproof external M2M antenna for use in telematics, transportation and remote monitoring applications. It includes two LTE MIMO antennas and one GPS/GLONASS/GALILEO antenna, in the highest efficiency and peak gain possible. This antenna particularly finds its application in mobile video, vehicle communications, location and fleet management, safety & security, remote industrial equipment monitoring. The antenna consists of two LTE MIMO elements 698-960MHz, 1710-2170MHz, 2300~2700MHz, 2900-3500MHz. The antennas are designed to work equally well on LTE to deliver maximum data rates, or on legacy 3G and 2G frequencies where LTE is not available.

The GNSS antenna is a wide-band GPS/GLONASS/GALILEO element tuned to have optimum gain at 1575.42 MHz GPS/GALILEO and 1602MHz GLONASS frequencies.

Mechanically, we have packed 3 high efficiency and gain antennas in an extremely robust IP67 direct mount antenna package with excellent isolation (20dB+). The strengthened domed housing is designed to deflect tree branches and wires that tend to catch and break shark fin or rigid whip antennas. The Pantheon has its own internal ground-plane and can radiate on any mounting environment such as metal or plastic without affecting performance. The internal components are individually screwed down onto a robust plate, preventing damage from regular vehicle vibrations. A completely waterproof mounting seal prevents water from leaking under the housing.

The connectors and cable length are customizable. It is also available in Black (MA710).

2. Specification Table

4G /3G/2G MIMO									
	LTE	GSM 850	GSM 900	DCS	PCS	WCDMA I	ISM	LTE	
Frequency	698~787	824~896	880~960	1710~1880	1850~1990	1920~2170	2400~2500	2600~3500	MHz
MIMO 1									
VSWR (max.)	2.5	2.5	3	2.5	2.5	2.5	3	2.5	
Efficiency	66.17	51.88	47.87	39.97	47.67	45.97	28.73	38.35	%
Peak Gain	2.52	1.48	1.15	1.03	1.22	1.22	0.15	3.20	dBi
MIMO 2									
VSWR (max.)	3.5	3.5	3.5	2.5	2.5	2.5	2	2.5	
Efficiency	35.98	18.41	20.24	40.85	35.42	37.68	42.27	35.24	%
Peak Gain	1.56	-2.08	-2.31	1.69	0.86	2.06	2.99	2.97	dBi
Polarization	Vertical								
Impedance	50 Ω								
GPS/GLONASS/GALILEO									
Centre Frequency	1575.42MHz / 1602MHz								
Bandwidth	10MHz								
Radiation Efficiency	50 % (without cable)								
Passive Gain @ Zenith	4.0 dBi typ.(with $\psi=140$ mm ground)								
VSWR	2								
Impedance	50Ω								
DC Power Input Range	1.8V ~ 5V								
DC input	1.8V		3.3V		4.0V		5.5V		
MHz	1575.42	1602	1575.42	1602	1575.42	1602	1575.42	1602	
VSWR	2	2	2	2	2	2	2	2	
LNA Gain	17	17	29.2	29	31	31	32.3	32	
Noise Figure	3.4	3.4	3.1	3.1	3.2	3.2	3.4	3.4	
Power Consumption	3.2	3.2	7.5	7.5	9.4	9.4	15	15	
Band Attenuation	1535MHz: -20dB 1642MHz: -20dB		1520MHz: -20dB 1642MHz: -20dB		1520MHz: -20dB 1642MHz: -20dB		1520MHz: -20dB 1642MHz: -20dB		
Cable	3m RG174 standard								
Connector	SMA(M) standard								

MECHANICAL	
Antenna Dimensions	Height 85.7mm x Diameter 145.6mm
Casing	Wonderloy PC-540 PC/ABS Alloy
Waterproof	IP67
4G/3G/2G MIMO 1	3M Low Loss CFD-200 SMA(M)
4G/3G/2G MIMO 2	3M Low Loss CFD-200 SMA(M)
GPS/GLONASS/GALILEO	3M RG-174 SMA(M)
ENVIRONMENTAL	
Operation Temperature	-40°C to 85°C
Storage Temperature	-40°C to 90°C
Humidity	Non-condensing 65°C 95% RH

* all measurements were conducted with 3m low loss CFD200 cable on cellular and RG-174 cable on GPS/GLONASS/GALILEO

LTE BANDS				
Band Number	LTE / LTE-Advanced / WCDMA / HSPA / HSPA+ / TD-SCDMA			
	Uplink	Downlink	MIMO 1	MIMO 2
1	UL: 1920 to 1980	DL: 2110 to 2170	✓	✓
2	UL: 1850 to 1910	DL: 1930 to 1990	✓	✓
3	UL: 1710 to 1785	DL: 1805 to 1880	✓	✓
4	UL: 1710 to 1755	DL: 2110 to 2155	✓	✓
5	UL: 824 to 849	DL: 869 to 894	✓	✗
7	UL: 2500 to 2570	DL: 2620 to 2690	✓	✓
8	UL: 880 to 915	DL: 925 to 960	✓	✗
9	UL: 1749.9 to 1784.9	DL: 1844.9 to 1879.9	✓	✓
11	UL: 1427.9 to 1447.9	DL: 1475.9 to 1495.9	✗	✗
12	UL: 699 to 716	DL: 729 to 746	✓	✓
13	UL: 777 to 787	DL: 746 to 756	✓	✓
14	UL: 788 to 798	DL: 758 to 768	✓	✓
17	UL: 704 to 716	DL: 734 to 746 (LTE only)	✓	✓
18	UL: 815 to 830	DL: 860 to 875 (LTE only)	✓	✗
19	UL: 830 to 845	DL: 875 to 890	✓	✗
20	UL: 832 to 862	DL: 791 to 821	✓	✗
21	UL: 1447.9 to 1462.9	DL: 1495.9 to 1510.9	✗	✗
22	UL: 3410 to 3490	DL: 3510 to 3590	✗	✗
23	UL: 2000 to 2020	DL: 2180 to 2200 (LTE only)	✓	✓
24	UL: 1625.5 to 1660.5	DL: 1525 to 1559 (LTE only)	✓	✓
25	UL: 1850 to 1915	DL: 1930 to 1995	✓	✓
26	UL: 814 to 849	DL: 859 to 894	✓	✗
27	UL: 807 to 824	DL: 852 to 869 (LTE only)	✓	✗
28	UL: 703 to 748	DL: 758 to 803 (LTE only)	✓	✗
29	UL: -	DL: 717 to 728 (LTE only)	✓	✓
30	UL: 2305 to 2315	DL: 2350 to 2360 (LTE only)	✓	✓
31	UL: 452.5 to 457.5	DL: 462.5 to 467.5 (LTE only)	✗	✗
32	UL: -	DL: 1452 - 1496	✗	✗
35		1850 to 1910	✓	✓
38		2570 to 2620	✓	✓
39		1880 to 1920	✓	✓
40		2300 to 2400	✓	✓
41		2496 to 2690	✓	✓
42		3400 to 3600	✓	✗
43		3600 to 3800	✗	✗

*Covered bands represent an efficiency greater than 20%

3. LTE MIMO

3.1. LTE MIMO 1 and LTE MIMO 2 Specification

3.1.1. Return Loss

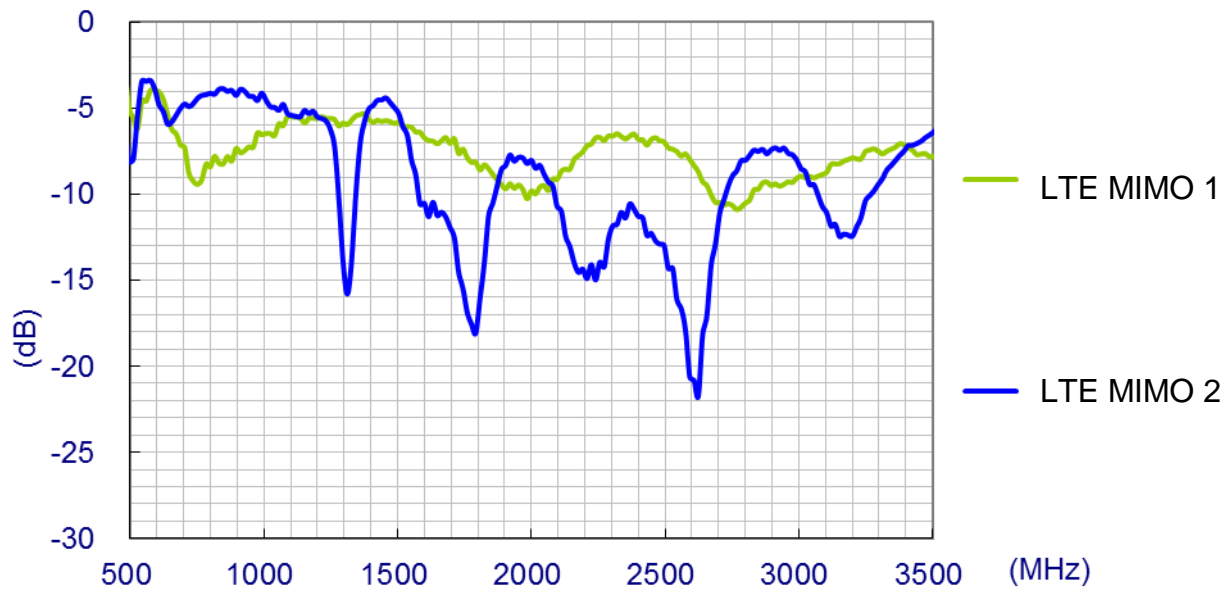

3.1.2. Maximum Gain

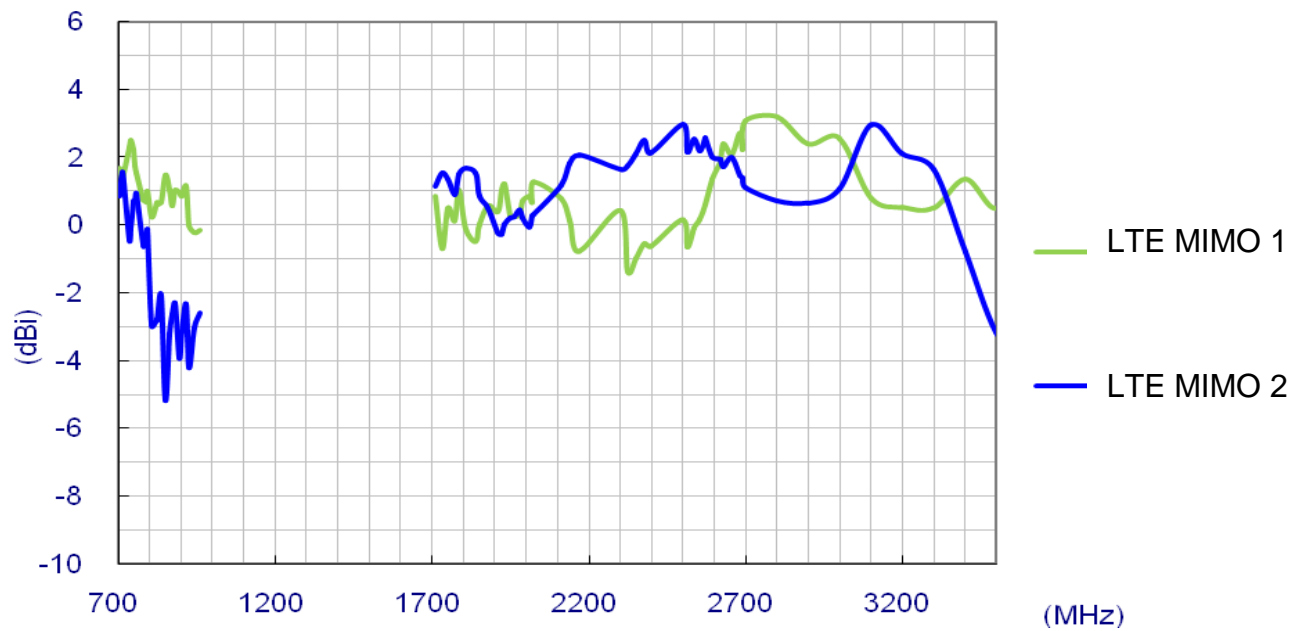

3.1.3. Average Gain

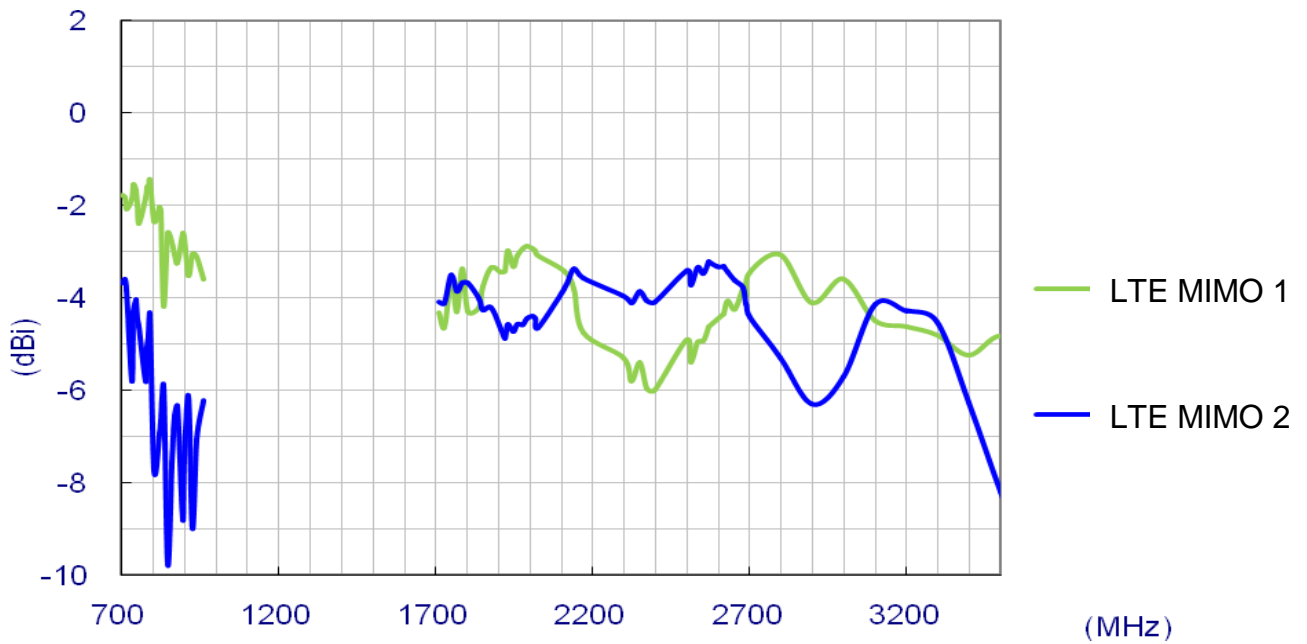

3.1.4. Efficiency

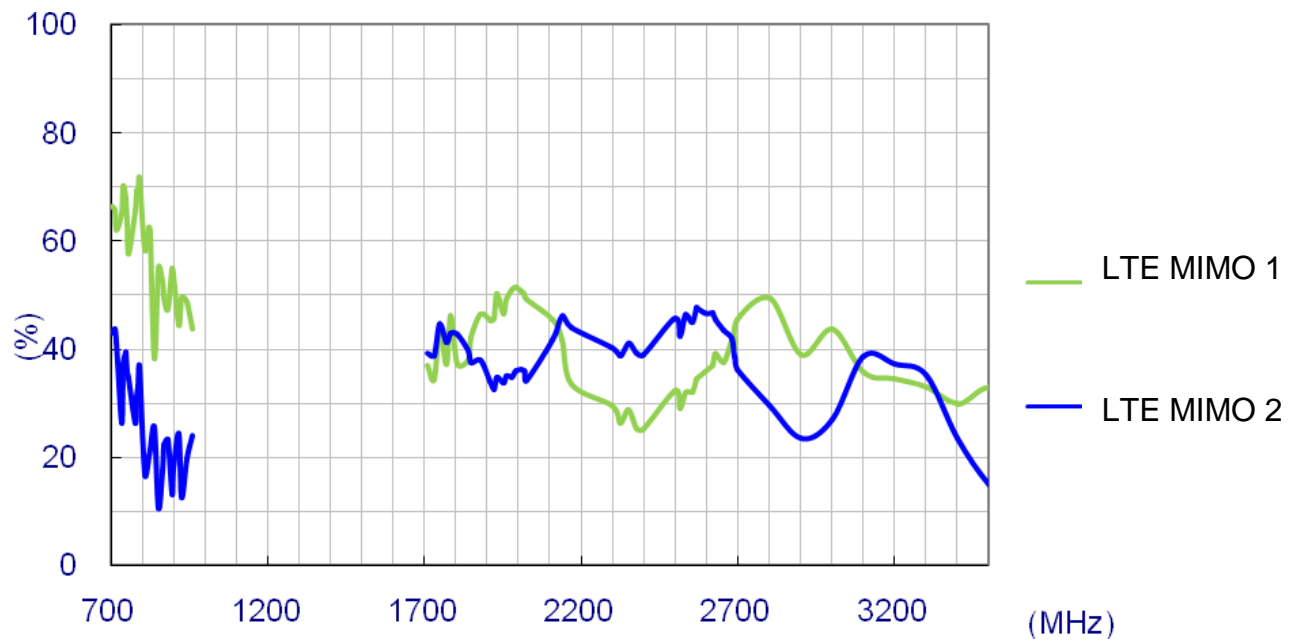

3.2. Radiation Patterns



3.2.1. LTE MIMO 1 Radiation Pattern

XY plane

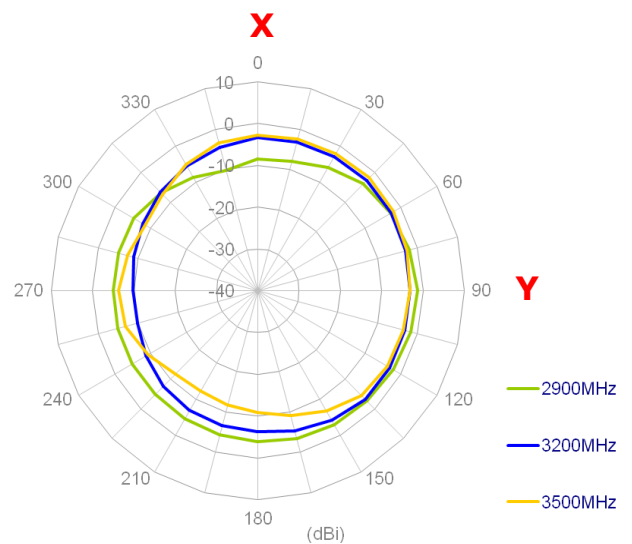
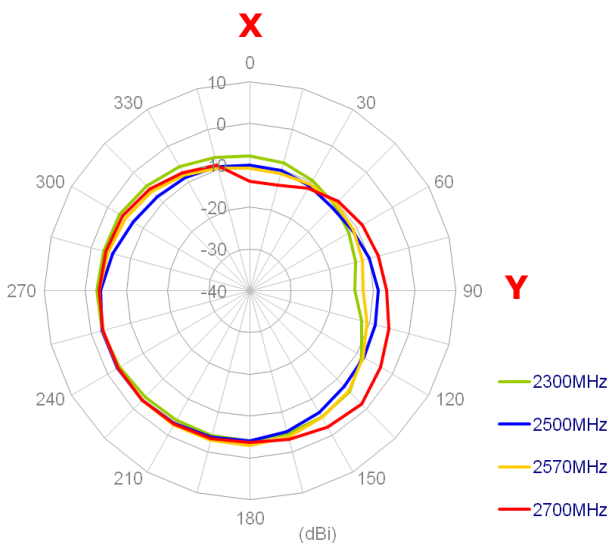
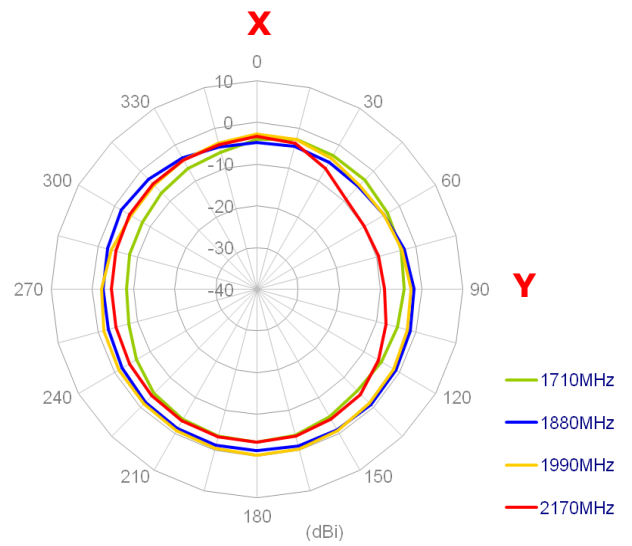
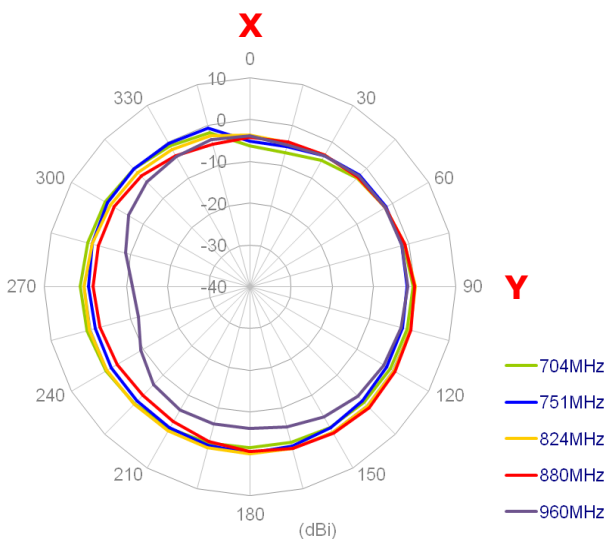

XZ Plane

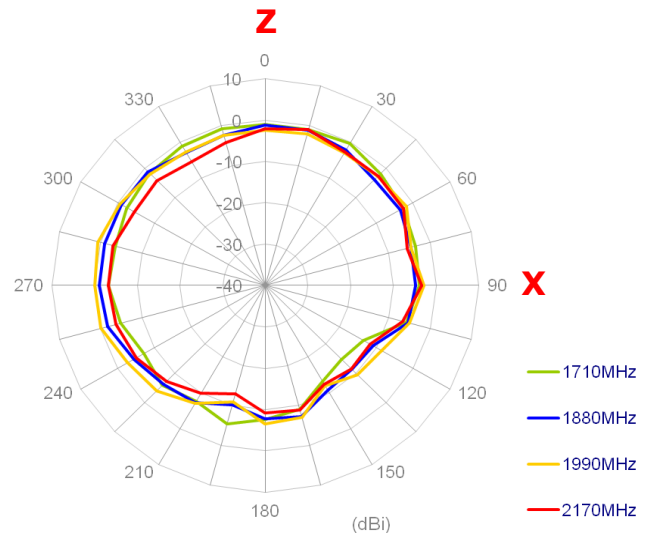
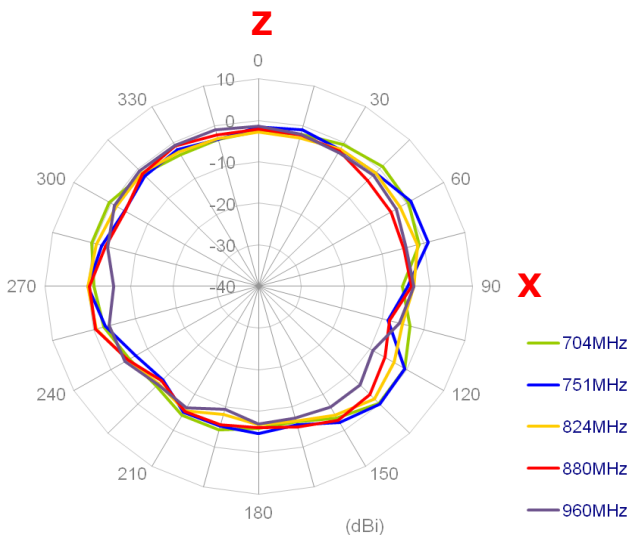

Z

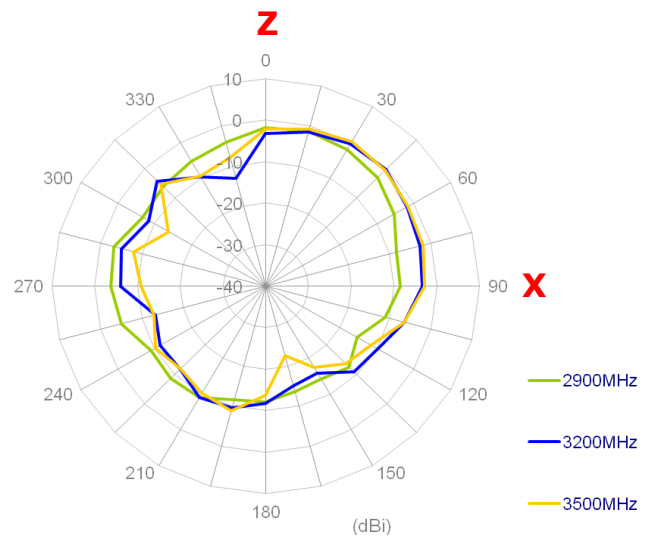
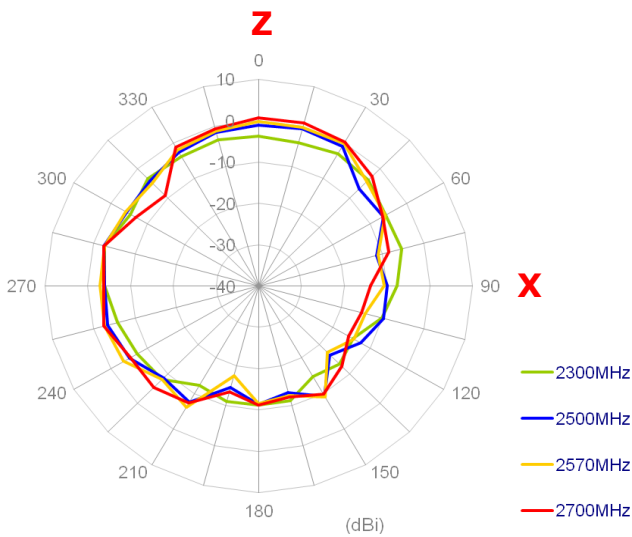

3.2.2. 3.2.2 LTE MIMO 2 Radiation Pattern

XY plane

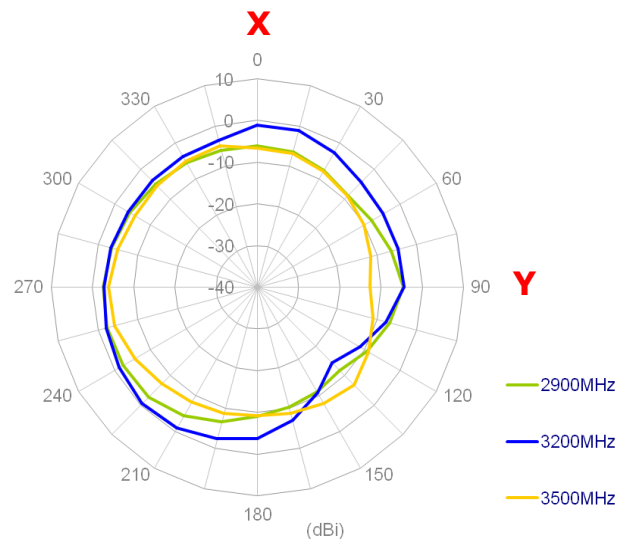
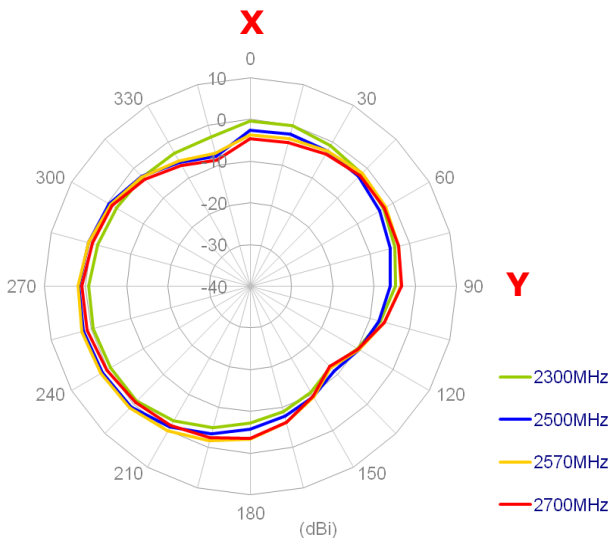
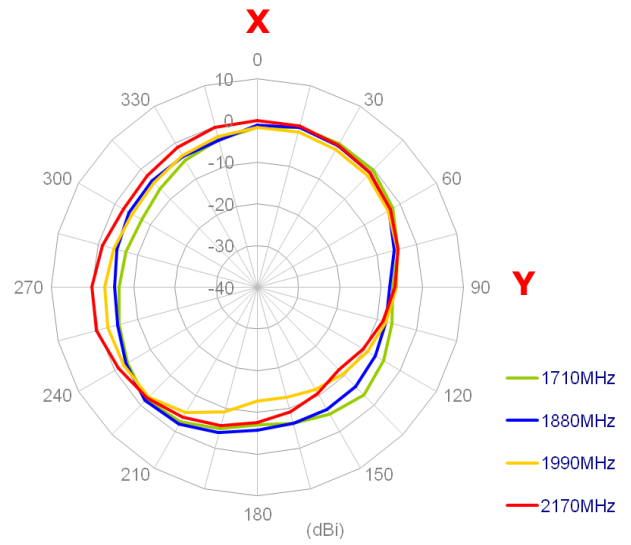
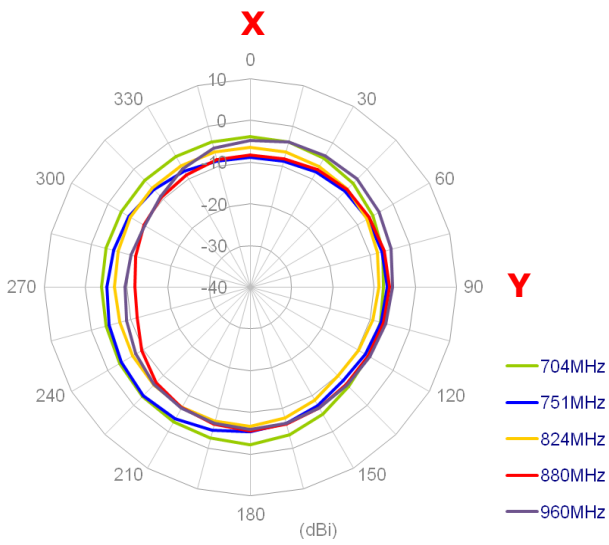

XZ Plane

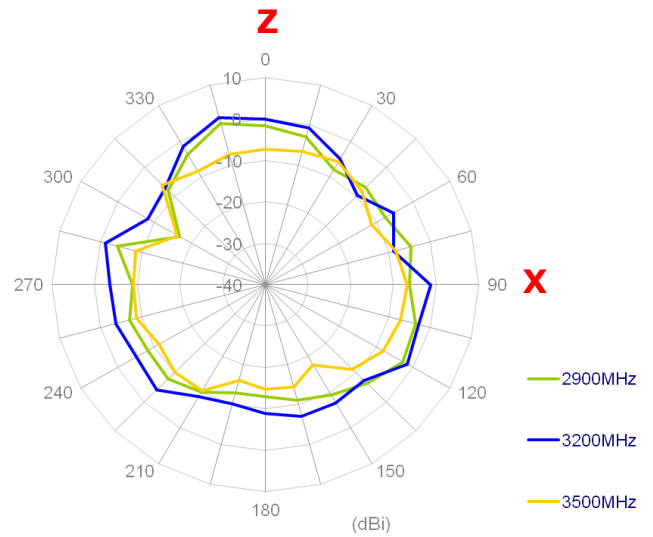
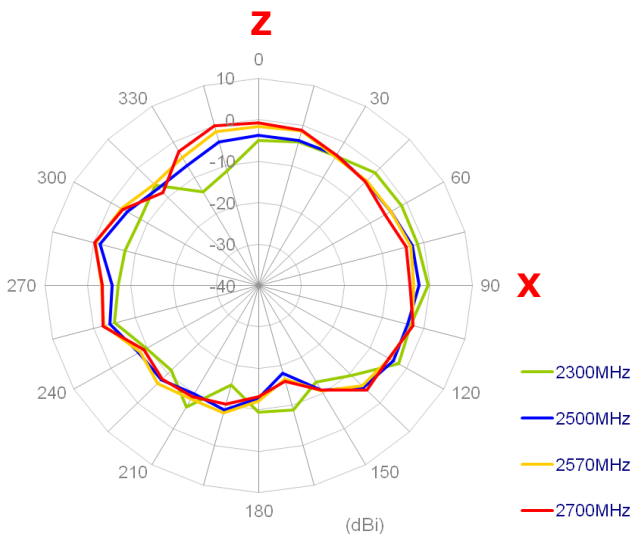
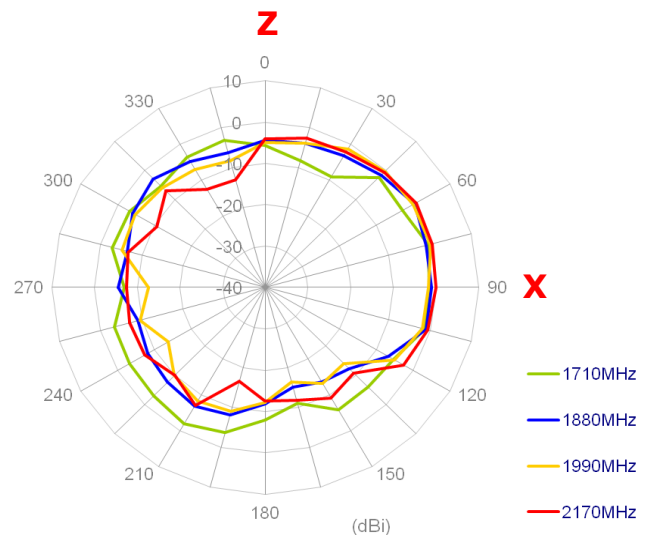
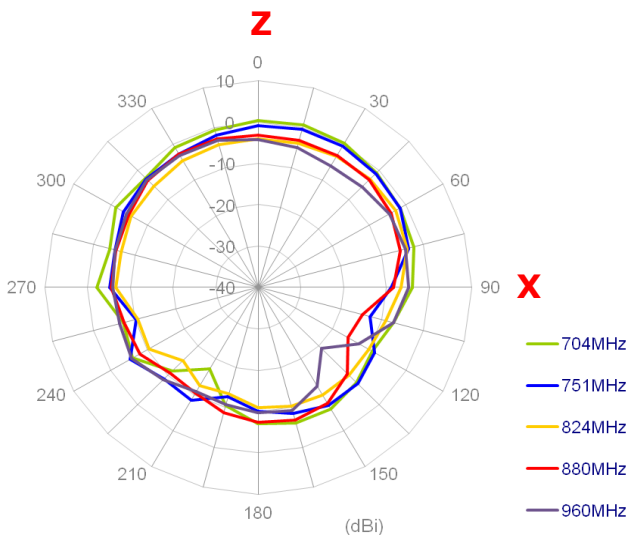

4. GPS/GLONASS/GALILEO

4.4. Block diagram

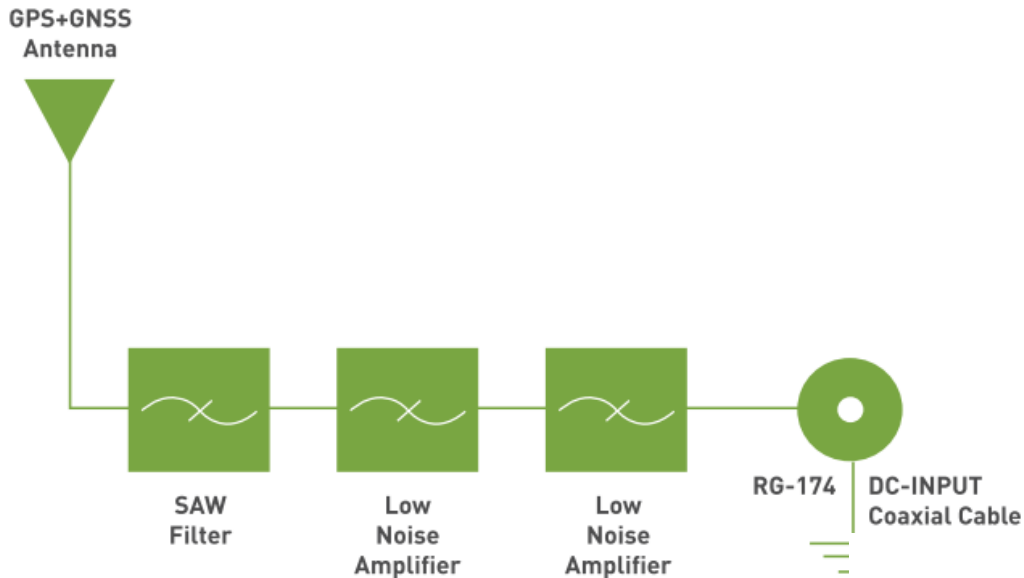

4.5. Return Loss

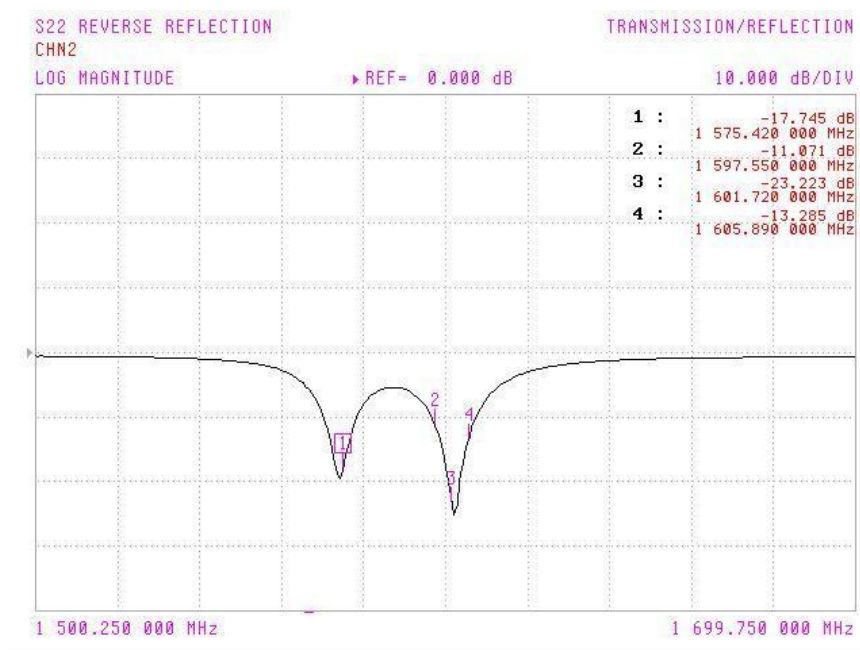

4.6. Radiation pattern



XYZ co-ordinate for reference.

XZ-plane Free Space @1575.42MHz

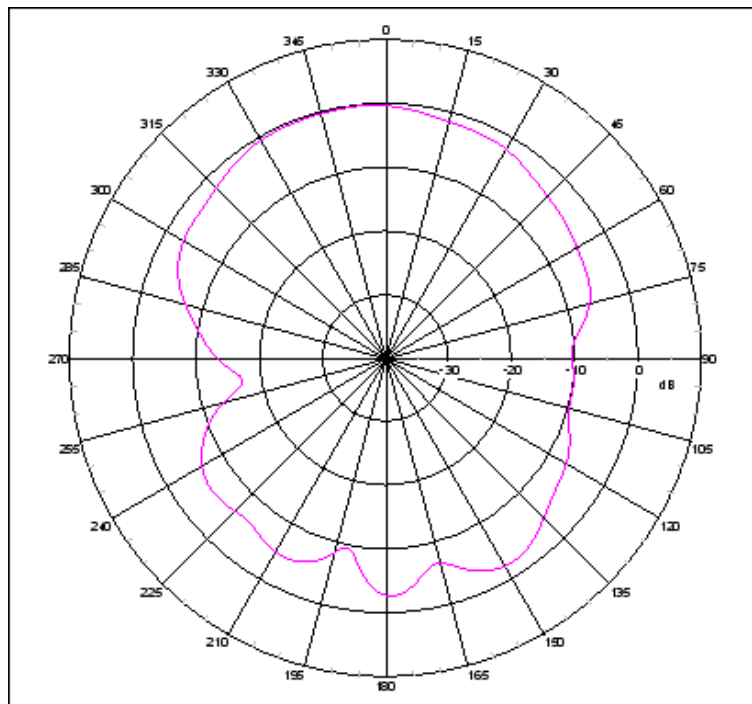

YZ-plane Free Space @1575.42MHz

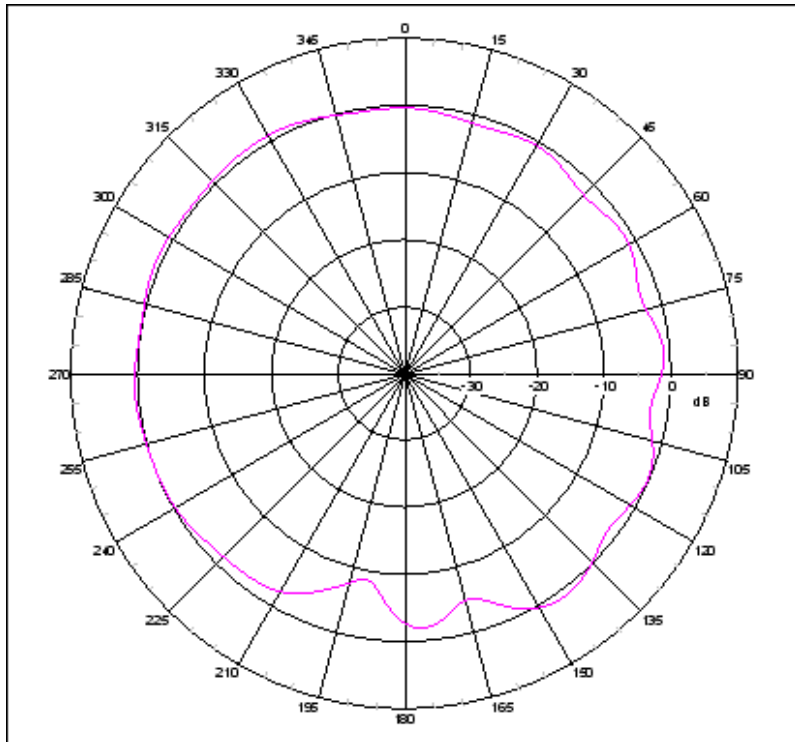

XZ-plane Free Space @1602MHz

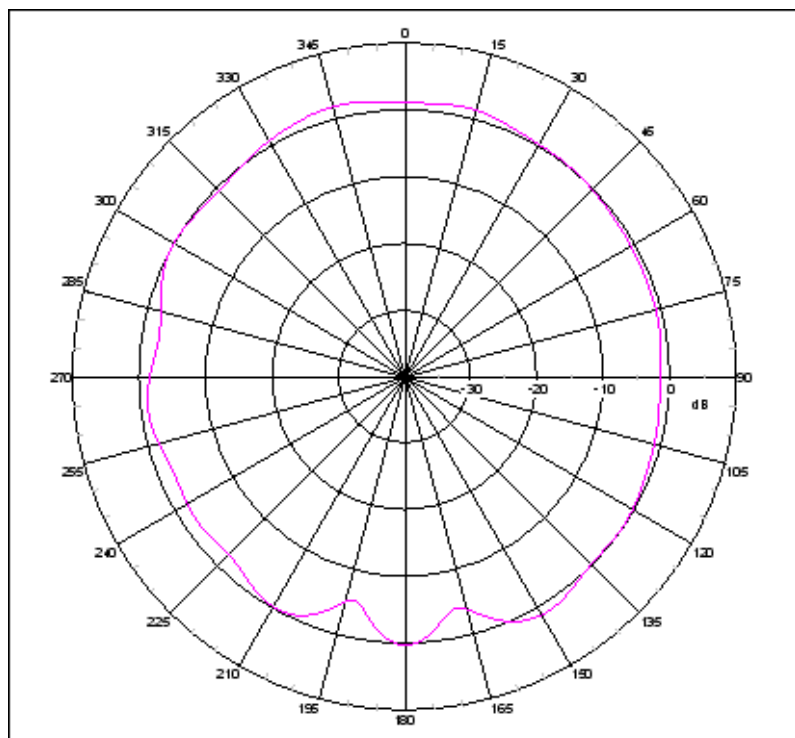

YZ-plane Free Space @1602MHz

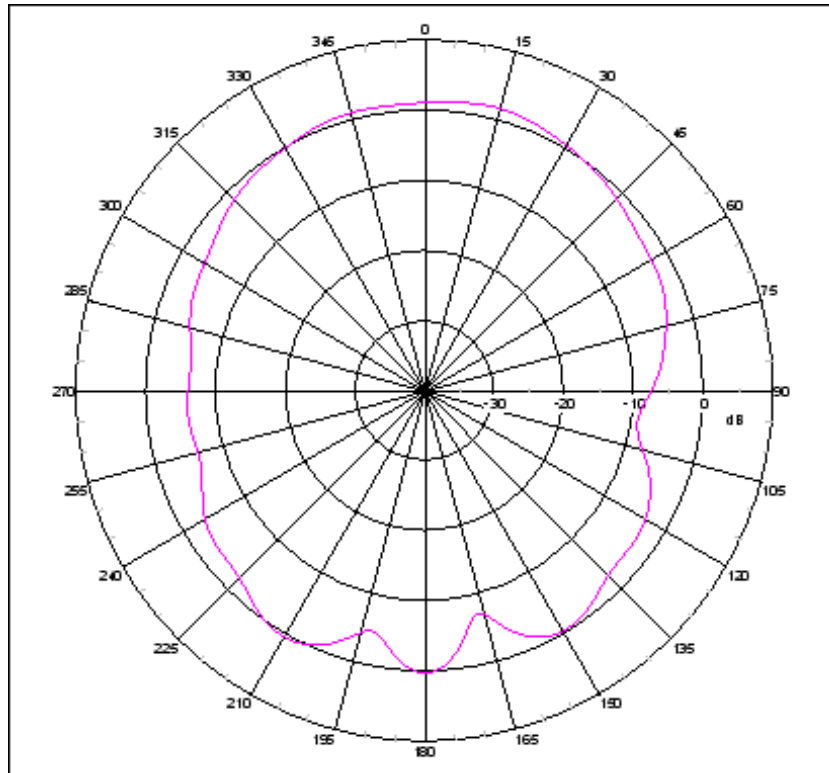

4.7. GPS/GLONASS/GALILEO LNA

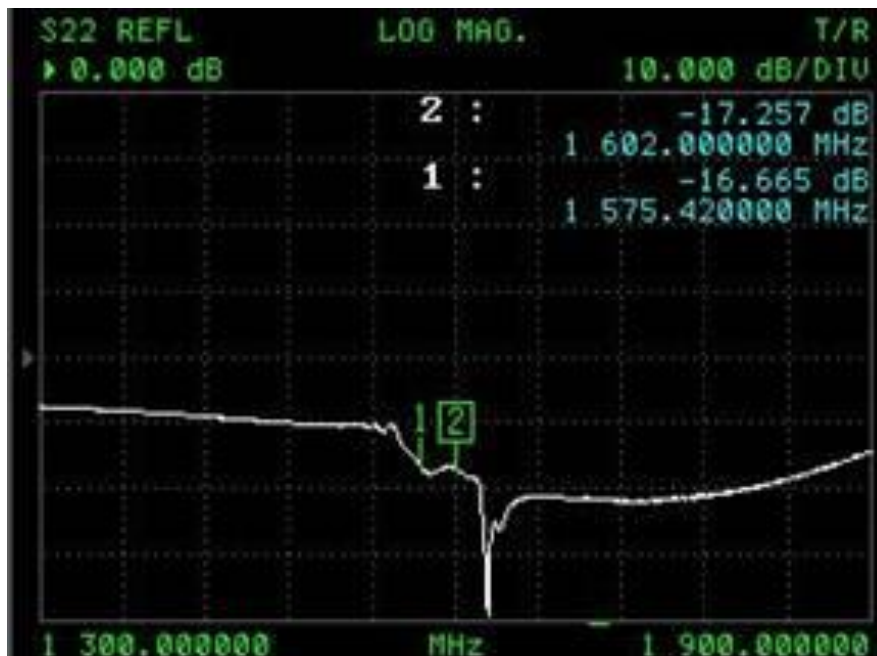
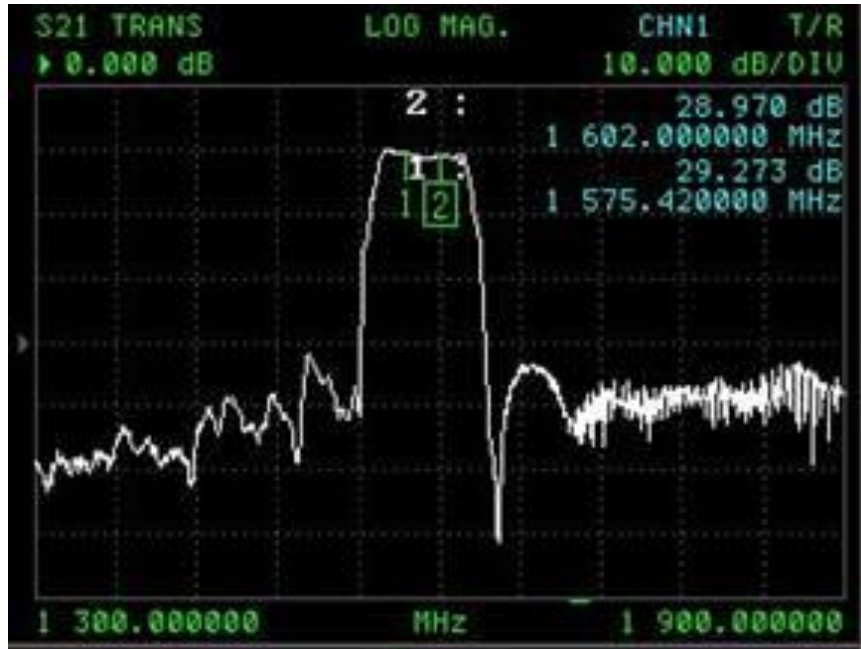

5. Mechanical Drawing

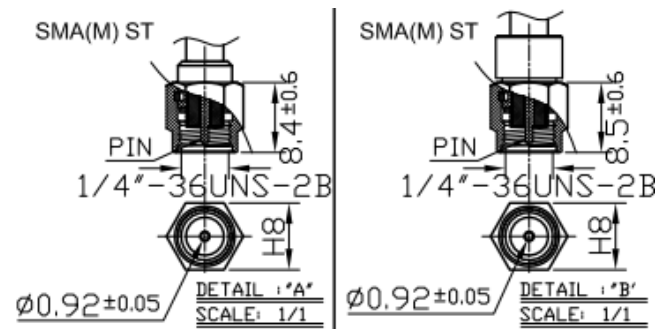
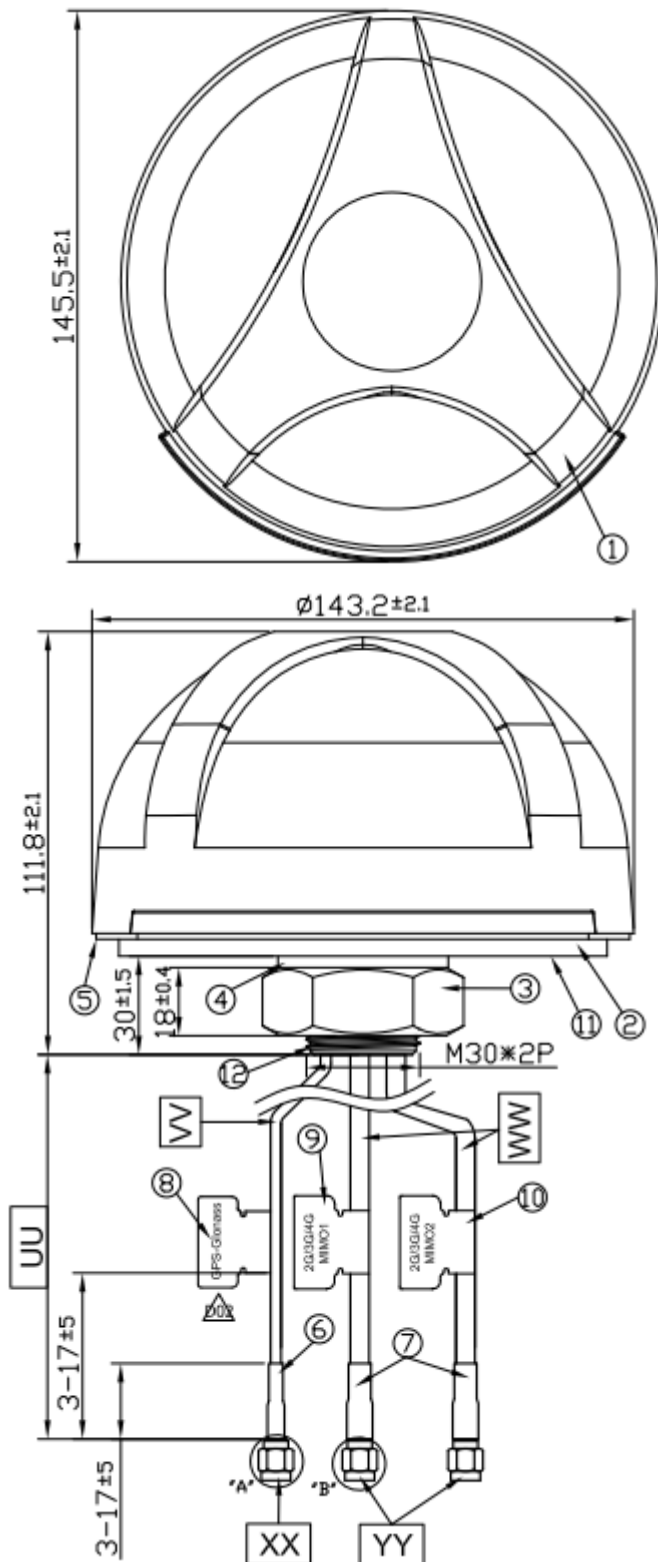

	Name	Material	Finish	QTY
1	Housing	PC 540	White	1
2	Closed Cell Foam	DP-3060W	Black	1
3	M30 Nut	Steel AISI 1215	Ni Plated	1
4	Washer	Steel AISI 1215	Ni Plated	1
5	Waterproof Gasket	Silicon Rubber	Black	1
6	Heat Shrink Tube	PE (RG174)	Black	1
7	Heat Shrink Tube	PE (CFD200)	Black	2
8	GPS-Glonass Label	Coated Paper	Orange	1
9	2G/3G/4G MIMO1	Coated Paper	Gray	1
10	2G/3G/4G MIMO2	Coated Paper	White	1
11	3M Double Adhesive	3M 9448 HK	White Liner	1
12	M30x 2 Thread 32L	Zinc Alloy	Ni Plated	1

	Name	Spec	Finish	QTY
UU	Cable Length	3000 \pm 120 mm		
VV	Cable Type	RG174	Black	1
WW	Cable Type	CFD200	Black	2
XX	Connector Type	SMA(M) ST	Gold	1
YY	Connector Type	SMA(M) ST	Gold	2

6. Packaging

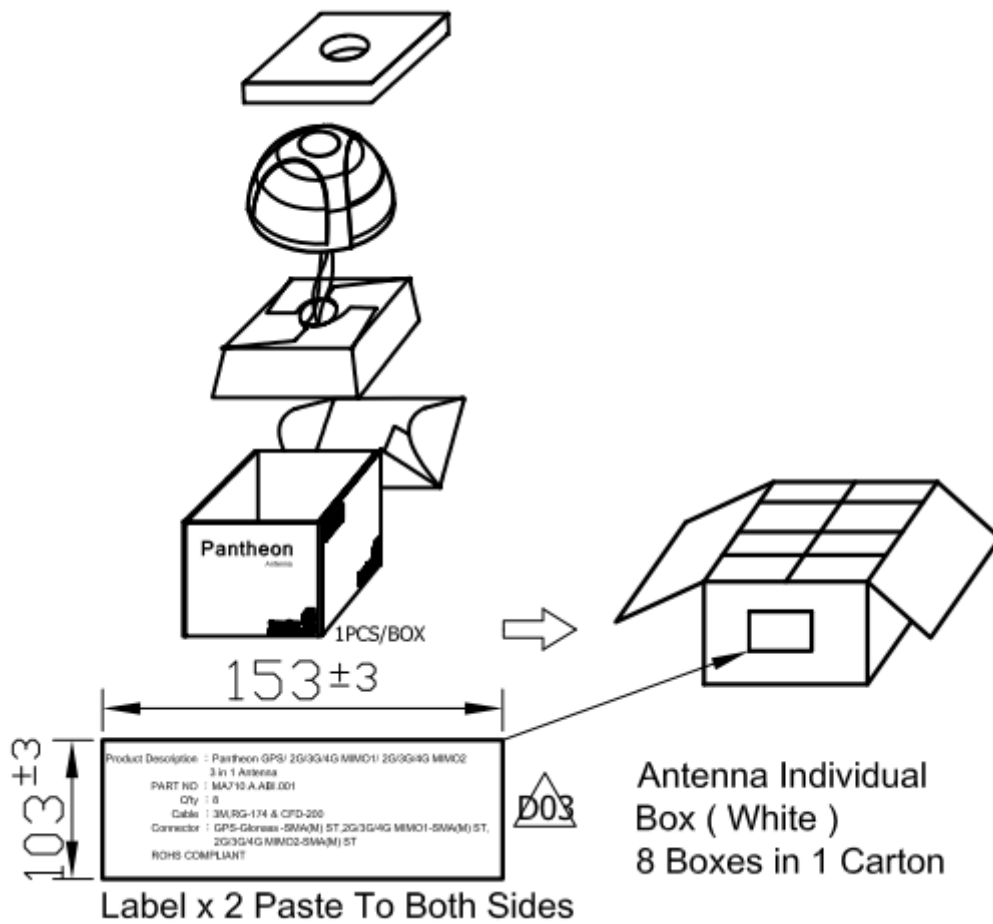

Taoglas makes no warranties based on the accuracy or completeness of the contents of this document and reserves the right to make changes to specifications and product descriptions at any time without notice. Taoglas reserves all rights to this document and the information contained herein.

Reproduction, use or disclosure to third parties without express permission is strictly prohibited.

Copyright © Taoglas Ltd.