



TAOGLAS®



Datasheet

Part No:

MA501.C.AC.001

Description:

Heavy Duty Screw Mount Antenna – GPS-GALILEO /
Dual-Band 2.4~5.2GHz

Features:

2.4GHz~5.2GHz suitable for ISM
Bands/ZigBee/WLAN/Bluetooth
IEEE.802.11/IEEE.802.15
UV and vandal resistant PC housing
IP67 & IP69K Waterproof Compliance
Height 29mm Diameter 49mm

✓ **RoHS**

✓ **REACH**
COMPLIANT

CE

1. Introduction	3
2. Specifications	5
3. Antenna Characteristics	7
4. 2D Radiation Patterns	10
5. 3D Radiation Patterns	11
6. Mechanical Drawing	13
7. Installation	14
8. Packaging	15

Taoglas makes no warranties based on the accuracy or completeness of the contents of this document and reserves the right to make changes to specifications and product descriptions at any time without notice. Taoglas reserves all rights to this document and the information contained herein.

Reproduction, use or disclosure to third parties without express permission is strictly prohibited.

Copyright © Taoglas Ltd.

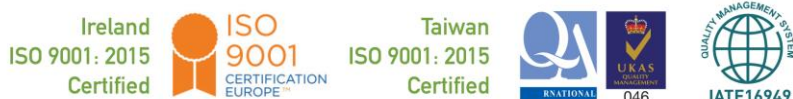

1. Introduction



MA501 is a combination of high performance GPS/GALILEO and dual band Wi-Fi (2.4/5.2GHz) antenna solution for reliable location information with localised data transfer via WLAN, Zigbee or Wi-Fi. This product incorporates the industry's most advanced GPS/GALILEO active ceramic patch technology (XtremeGain™) allowing for gains of up to 300% in accuracy compared to traditional antennas. Time to first fix is under 1 minute with all of the industry leading GPS/GALILEO receivers. XtremeGain technology means the antenna has been tuned for the Hercules environment giving you the optimum antenna solution to enable elimination of data gaps.

The 2.4/5.2GHz antenna inside has also been tuned for this enclosure; hence performance is excellent at all bands meaning the antenna works worldwide.

It was designed mainly for commercial vehicle and outdoor equipment installations, with extra thick threads, with the cables exiting through the bottom for ease of install. Durable and robust UV resistant PVC housing is resistant to vandalism and direct attack. It is designed for covert mounting as it is only 3cm high when mounted, thus complies with the latest EU directives for height restrictions.

The antenna housing is completely waterproof to IP67, and also to IP69K, which means it is waterproof against high pressure water jets used in industrial environments for cleaning.

1.1 Features

GPS / GALILEO

- High LNA Gain up to 32 dB \pm 2 dB
- Miniaturized – diameter 49mm
- Low Noise (1.5 dB max)
- Resides in its own chamber and is tuned for the Hercules environment to enhance performance

WLAN / Wi-Fi

- Advanced dual-band antenna for worldwide application
- Tuned for the Hercules environment to enhance performance

Other

- Weatherproof (IP67 & IP69K) with robust foam seal
- Quality textured covert and low profile design
- UV and Vandal resistant PC housing

2. Specifications

GPS/GALILEO						
Frequency	1575.42MHz					
Average Gain	32dB typ.					
Gain @ Zenith	2.0dBi min.					
Gain @ 10 o Elevation	-4.0dBi min.					
Axial Ratio	3.0dB max.					
Polarization	Right Hand Circular					
VSWR	<=2.0:1					
Impedance	50Ω					
Noise Figure	1.5dB max.					
Bandwidth	10Mhz min.					
LNA Out-band Attenuation	fo = 1575.42MHz fo ± 30 MHz 5dB Min. fo ± 50 MHz 20dB Min. fo ± 100 MHz 25dB Min.					
Input Voltage	Min:1.8V	Typ. 3.0V			Max: 5.5V	
Total Gain @ Zenith	25dBic	30dBic			32dBic	
Current Consumption	6mA	12mA			30mA	
Noise Figure	2.7dB	3.0dB			3.7dB	
Cable	3m RG174 standard, fully customizable					
Connector	SMA(M) standard, standard, fully customizable					
Wi-Fi						
Frequency (GHz)	2.40	2.45	2.50	5.15	5.25	5.35
Average Gain (dBi)	-2.24	-2.06	-2.19	-3.74	-4.26	-3.84
Peak Gain (dBi)	3.05	4.05	4.11	4.74	4.37	4.71
Efficiency	63.3%	68.9%	66.4%	50.0%	41.6%	47.5%
Return Loss (dB)	-14.5	-12.1	-12.7	-11.4	-15.3	-14.2
VSWR	<=1.8:1					
Impedance	50Ω					
Polarization	Linear - Horizontal					
Radiation Pattern	Omni					
Cable	3m NFC-200 standard, fully customizable					
Connector	RP-SMA(M) standard, standard, fully customizable					

Mechanical	
Dimensions	Height 29mm x Diameter 49mm
Casing	UV resistant PC
Base and thread	Nickel plated Zinc Alloy
Thread diameter	18mm
Weather proof gasket	CR4305 foam with 3M9448B double-side adhesive
Cable pull	8 Kgf
Weight	0.475kg
Recommended Mounting Torque	24.5N·m
Maximum Mounting Torque	29.4N·m
Environmental	
Waterproof	IP67 & IP69K
Corrosion	5% NaCl for 48hrs - Nickel plated zinc alloy base and thread
Temperature Range	-40°C to +85°C
Thermal Shock	100 cycles -40°C to +80°C
Humidity	Non-condensing 65°C 95% RH
Shock (drop test)	1m drop on concrete 6 axes

3. Antenna Characteristics

3.1 Return Loss - WiFi

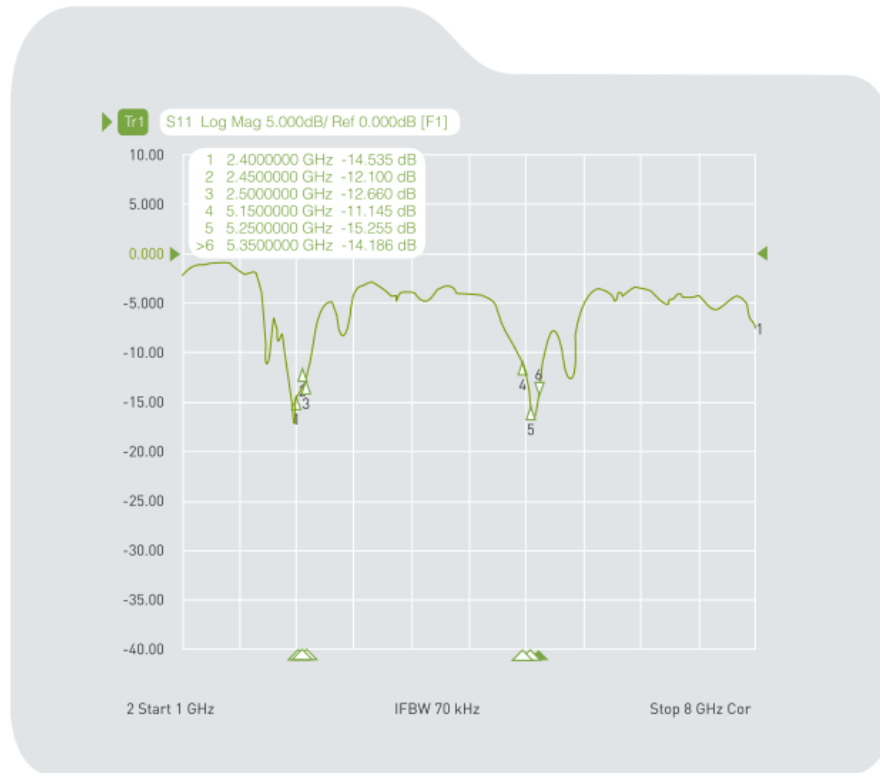

3.2 VSWR - WiFi

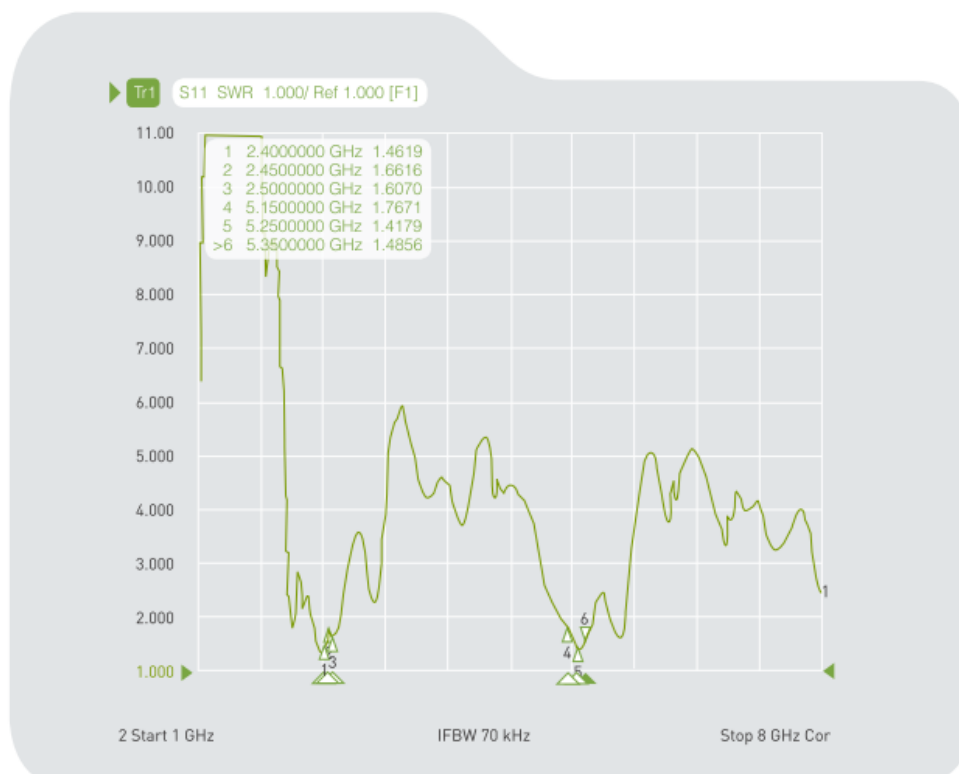

3.3 System Block Diagram

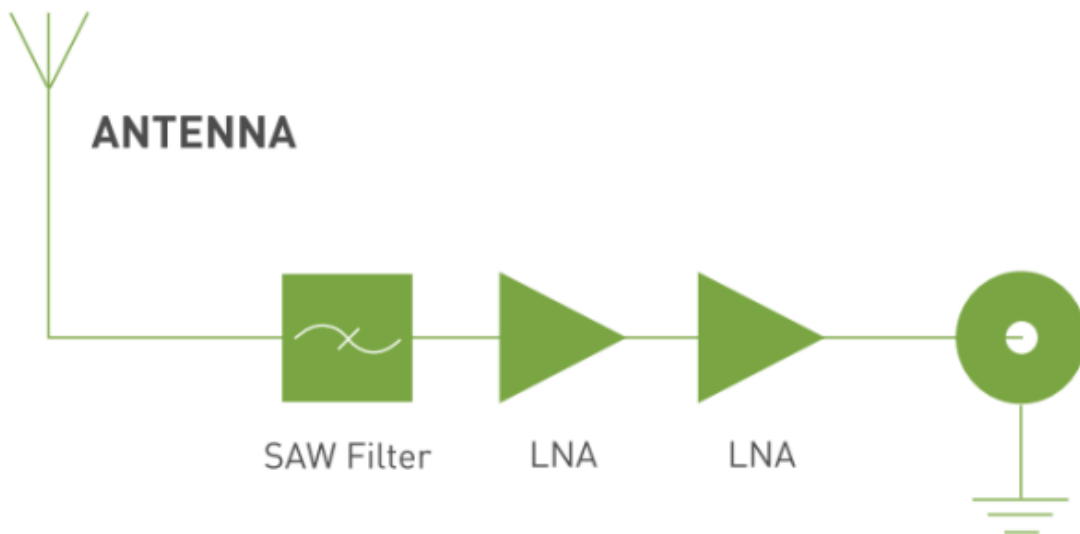

3.4 LNA Gain and Out-band Rejection

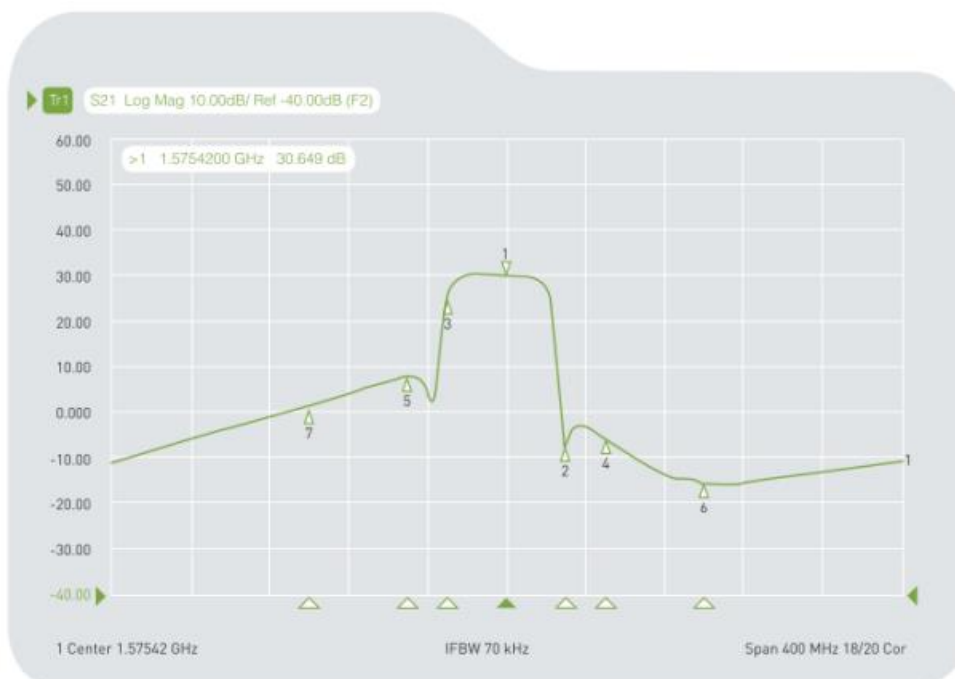

Cg1	Tr1	S21	>1	1.5754200 GHz	30.649 dB
Cg1	Tr1	S21	2	1.6054200 GHz	-6.7098 dB
Cg1	Tr1	S21	3	1.5454200 GHz	24.584 dB
Cg1	Tr1	S21	4	1.6254200 GHz	-5.6354 dB
Cg1	Tr1	S21	5	1.5254200 GHz	8.0734 dB
Cg1	Tr1	S21	6	1.6754200 GHz	-15.436 dB
Cg1	Tr1	S21	7	1.4754200 GHz	-1.5714 dB

3.5 Noise Figure

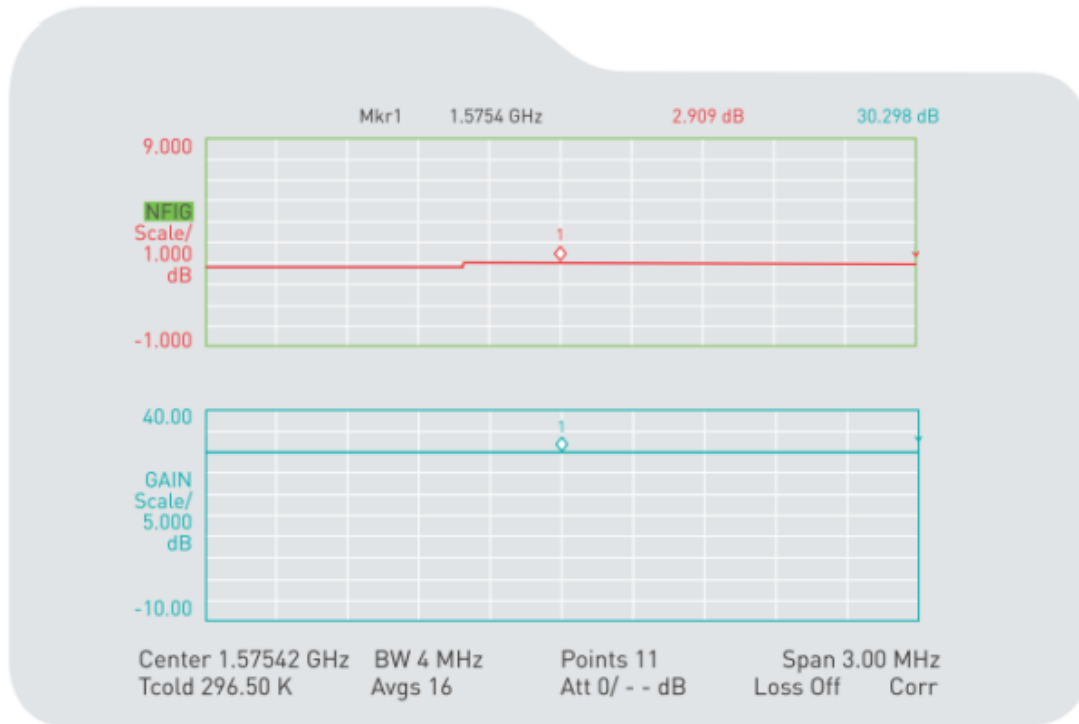

4. 2D Radiation Patterns

4.1 Test Setup

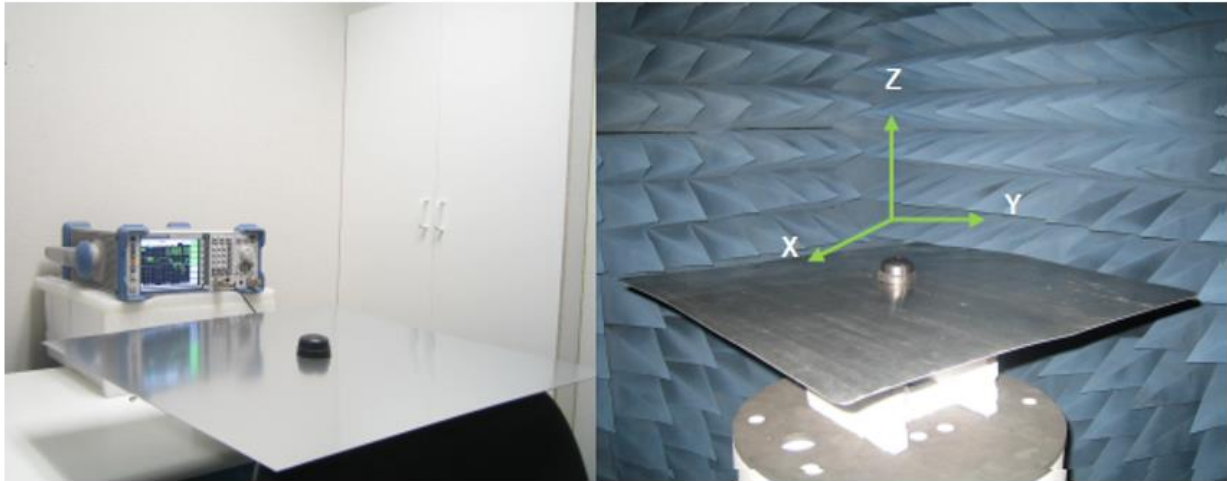

60*60cm Metal Plate

4.2 GPS/GALILEO Patch

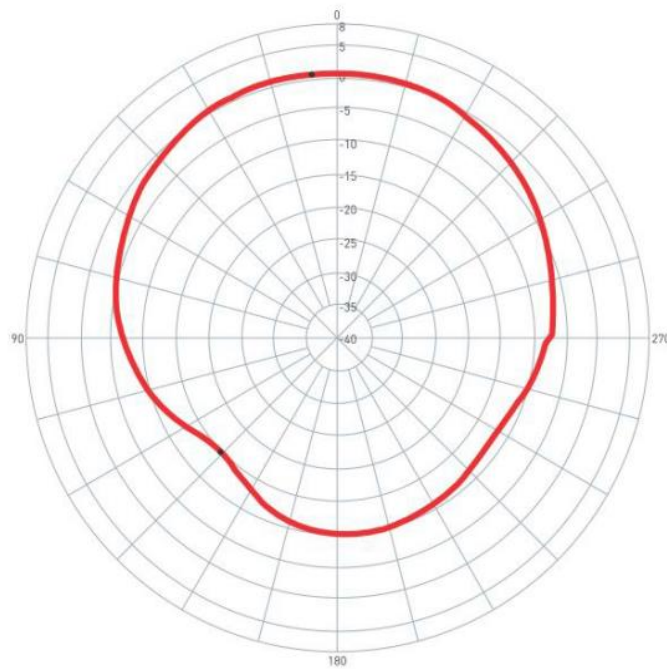

0 degree is the top of Hercules.

5. 3D Radiation Patterns

5.1 60*60cm Metal Base

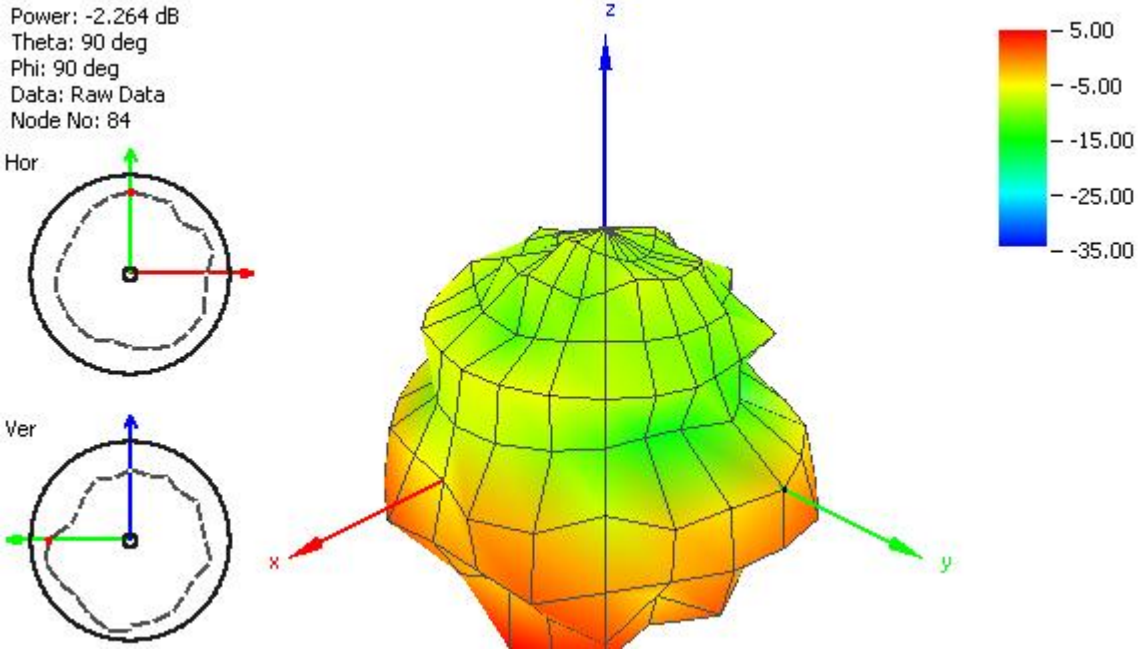

2500 MHz

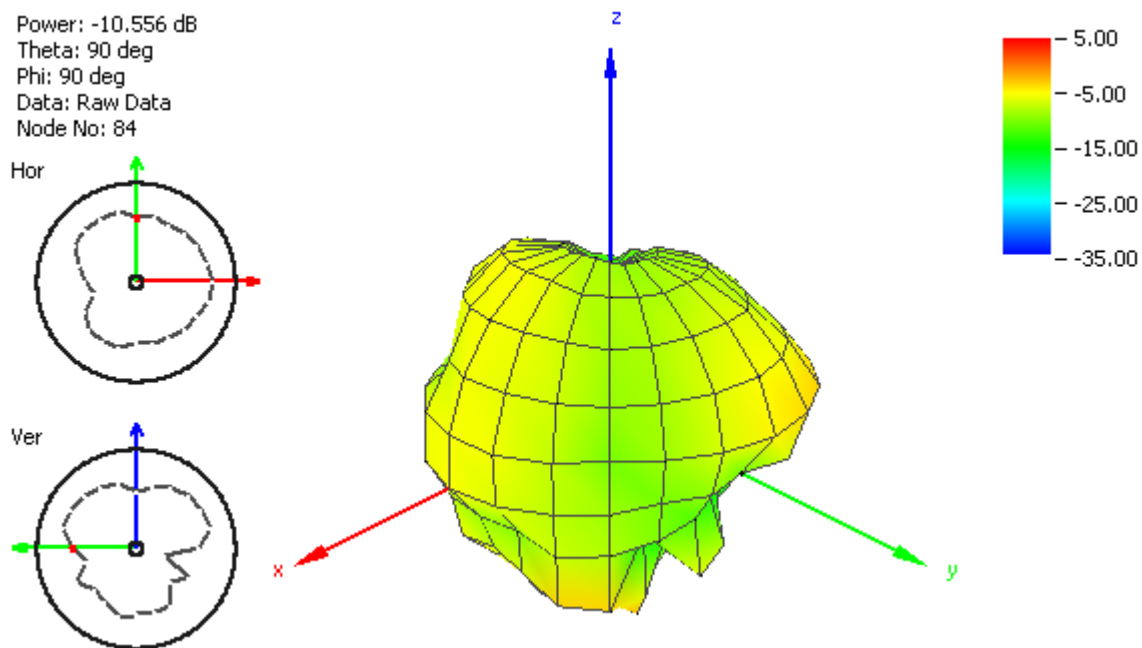

4900 MHz

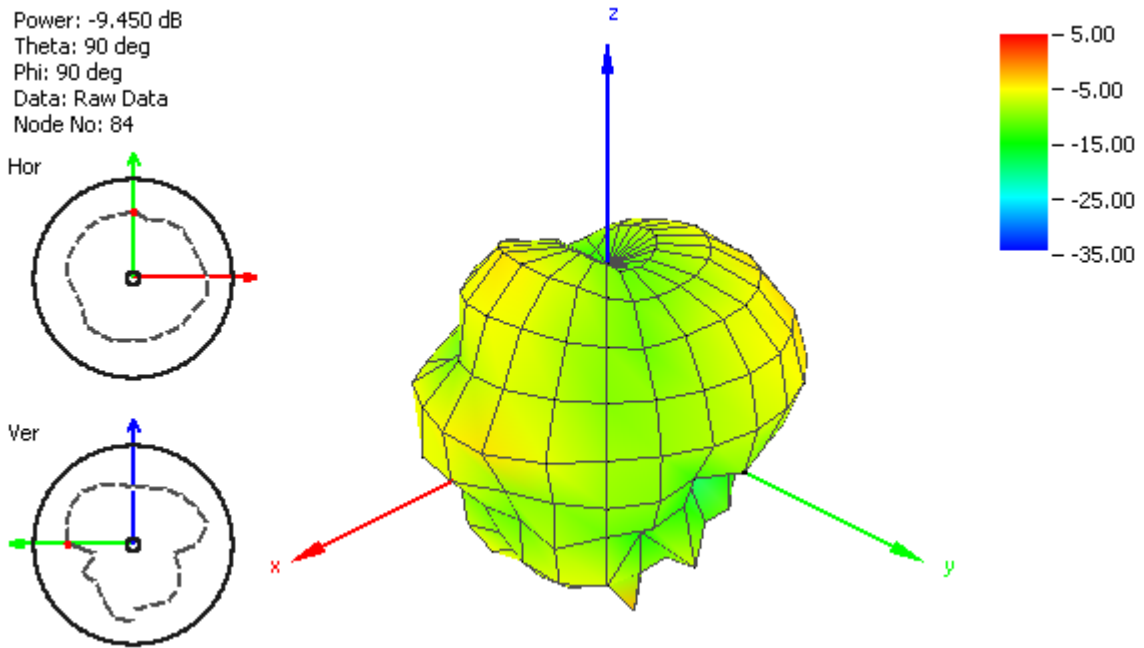

5150 MHz

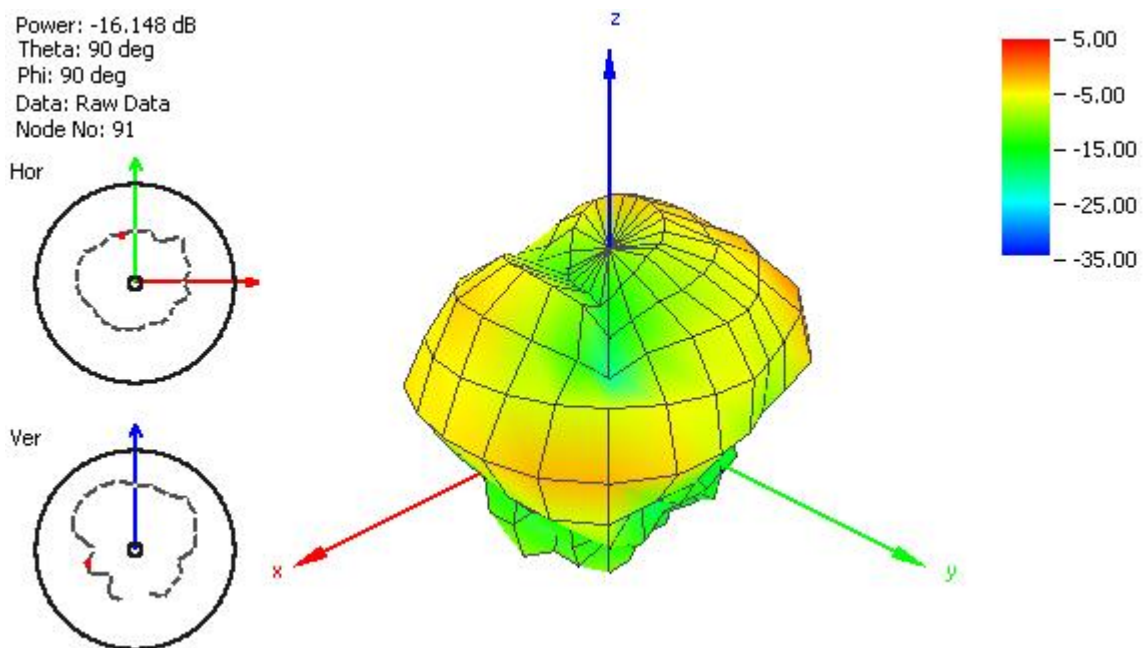

5850 MHz

6. Mechanical Drawing (Units: mm)

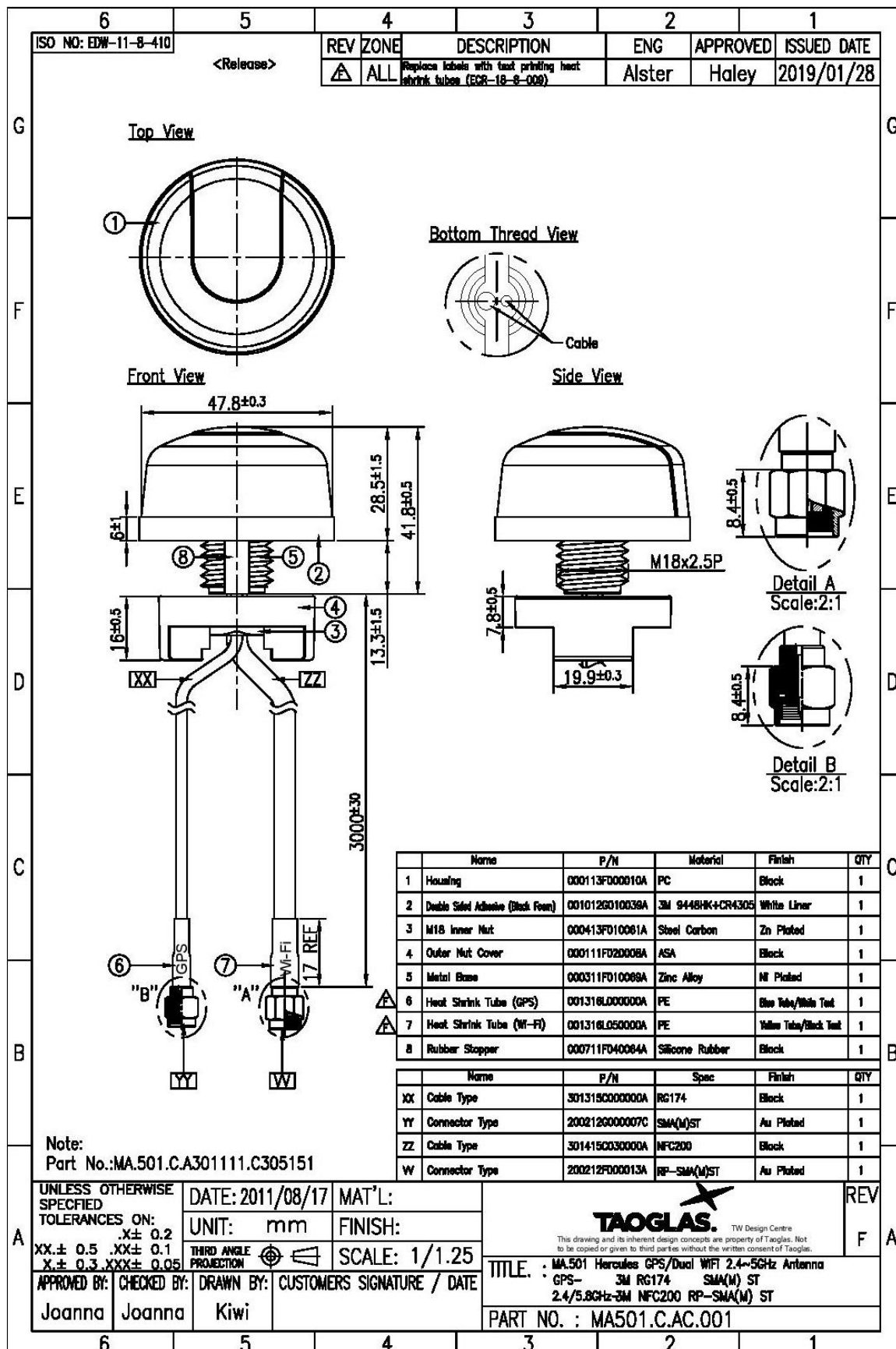

7. Installation

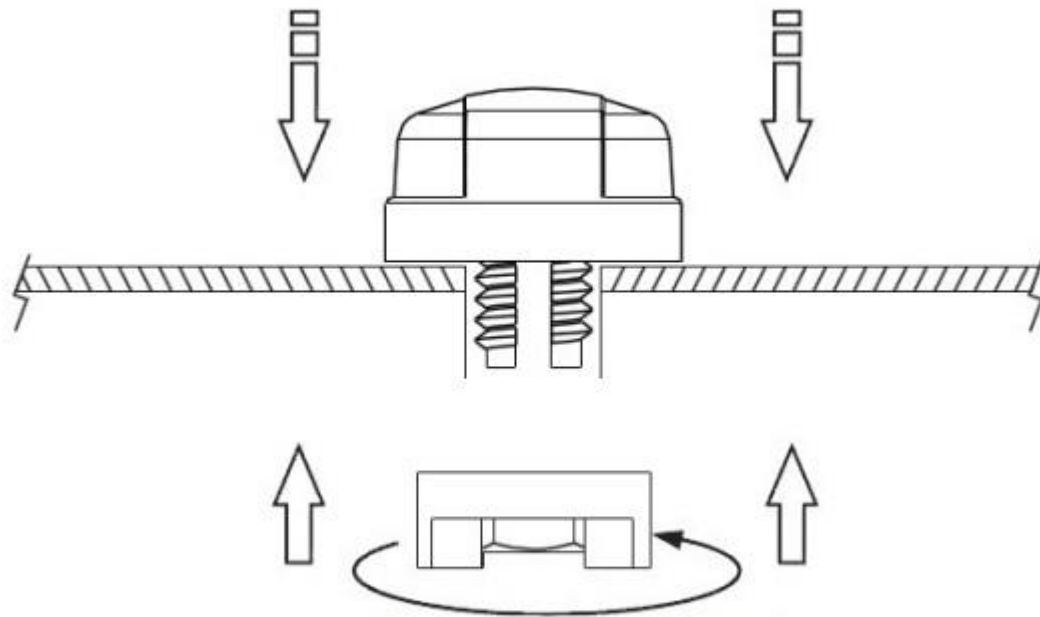

Recommended torque for Mounting is 24.5N·m
 Maximum torque for mounting is 29.4N·m

8. Packaging

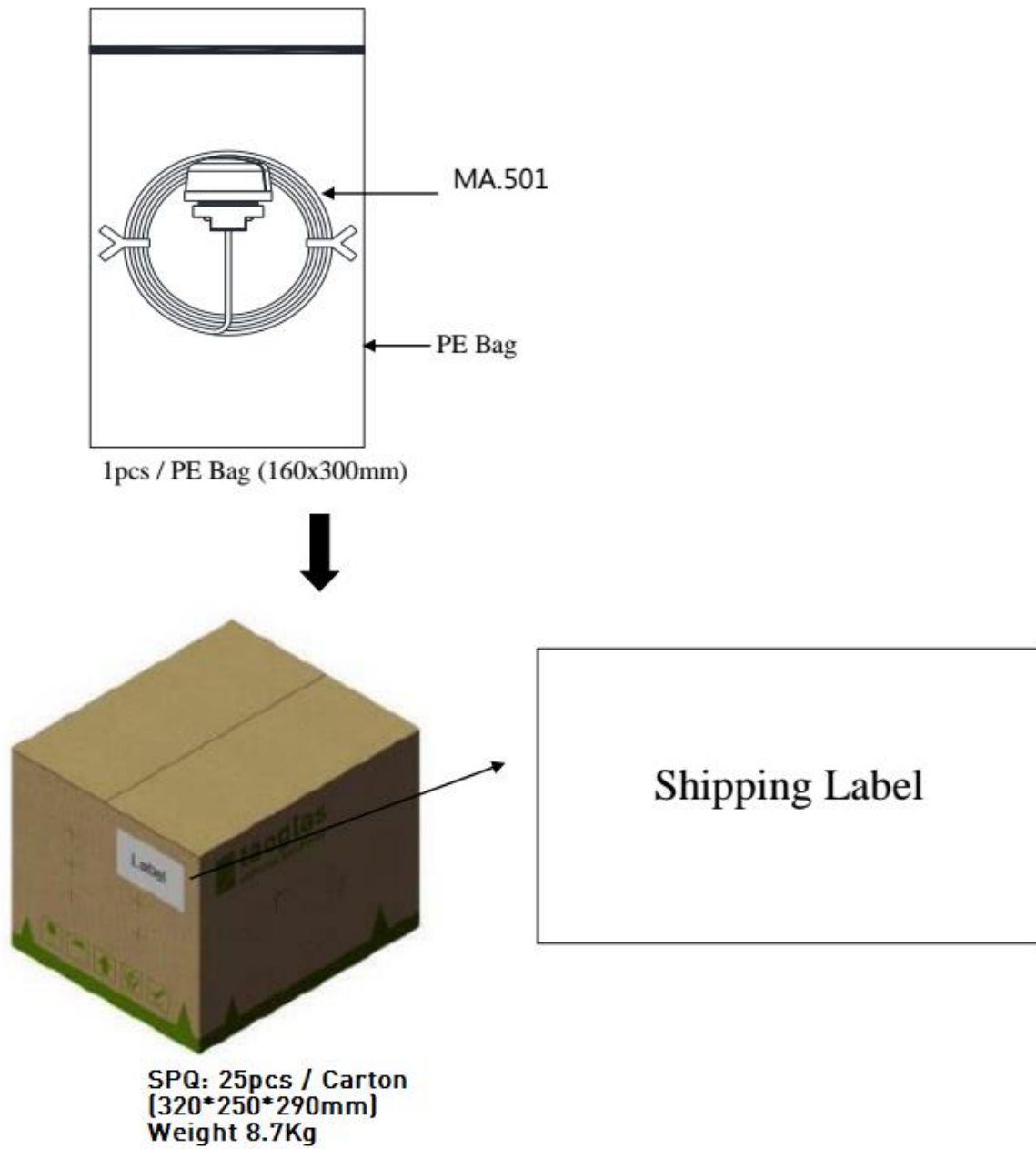



TAOGLAS®

www.taoglas.com

