

## SPECIFICATION

- Part No. : **MA303.A.LB.002**
- Product Name : MA303 SAUCER Magnetic Mount  
GPS/GLONASS and Cellular 2G/3G 2in1  
Combination Antenna
- Features : IP65 – Water Resistant  
- GPS/GLONASS - High gain LNA up to 31dB  
- Cellular 2G/3G - 850/900/1800/1900/2100 MHz  
GSM/GPRS/CDMA/PCS/DCS/UMTS/HSPA  
Low Profile, Robust and Stylish Design  
Magnetic Mounted  
58.15mm x 56.2mm x 16.8mm  
1 meter RG174 SMA(M)  
RoHS Compliant



## 1. Introduction

The MA303 SAUCER antenna is a combination small form factor high performance GPS/GLONASS and 2G/3G Cellular GSM/GPRS/CDMA/ PCS/DCS/ WCDMA/UMTS antenna to simplify remote monitoring and fleet management worldwide.

It comes with magnetic mount as standard. An internal O-ring meets IP-65 waterproof standards. With the strongest GPS/GLONASS and Cellular antenna design team in the industry and rigorous testing Taoglas offers guaranteed performance with your system and your environment. A front end SAW helps prevent LNA compression and burn out from nearby high power wireless transmissions. It also reduces radiated spurious emission failures in certification. An integrated strain resist helps prevent cable damage from accidental tension on the cable.

The standard MA303 version comes with 1 metres RG174 cable and SMA(M) connectors for both GPS/GLONASS and Cellular feeds. Cables and connectors are customizable upon request. Due to typical RF losses, 1 metre cable length is optimal, it is not recommended to use longer than 3 metre cables. Contact your regional Taoglas sales office for more details.

### Features

#### GPS/GLONASS

- High LNA Gain up to 31 dB
- Antenna Gain  $28 \pm 2$  dB
- Miniaturized to 56.2 x 16.8 mm
- Low Noise Figure 2.8 dB typ. for GPS  
3.2 dB typ. for GLONASS
- Ultra-Low Power Consumption 7~10mA typ. ( at 3.3V DC)

#### Cellular

- Advanced 2G/3G cellular antenna GSM/GPRS/CDMA/PCS/DCS/WCDMA/UMTS/HSPA
- GSM850: 824~896MHz, GSM900: 880~960MHz,
- DCS: 1710~1880MHz, DCS: 1850~1990MHz
- UMTS/WCDMA/HSPA: 1920~2170MHz

#### Other

- IP65 Water Resistant due to Internal O-Ring Structure
- Quality textured covert design. Low profile.
- ABS housing
- Optional cables and connectors
- ROHS Compliant

## 2. Specification

2G/3G Antenna					
	GSM850	GSM900	DCS	PCS	WCDMA I / UMTS
Frequency (MHz)	824~894	880~960	1710~1880	1850~1990	1920~2170
In Free Space					
Peak Gain (dBi) *	-1.48	-3.01	1.36	0.94	1.04
Average Gain (dBi) *	-5.21	-6.54	-3.63	-4.46	-4.37
Efficiency (%)*	30.75	22.19	43.53	35.91	36.71
On 30cmX30cm Ground Plane					
Peak Gain (dBi) *	-0.08	-0.43	-1.32	0.43	-0.28
Average Gain (dBi) *	-6.05	-6.65	-7.96	-6.82	-6.81
Efficiency (%)*	25.43	22.10	16.03	21.58	22.03
On the Glass Base					
Peak Gain (dBi) *	-2.56	-3.31	1.24	0.32	0.86
Average Gain (dBi) *	-6.63	-7.66	-3.88	-4.48	-4.31
Efficiency (%)*	21.76	17.45	40.96	35.85	37.66
Return loss (dB) *	< -5				
Polarization	Linear				
Impedance	50Ω				
Cable	1m RG174 standard, fully customizable				
Connector	SMA(M), standard, fully customizable				
Maximum Input Power	5W				

GPS-GLONASS	
Center Frequency	GPS:1575.42±3 MHz GLONASS:1602±3 MHz
Gain	-1 dBic typ.
VSWR	1.92:1 Max
Impedance	50Ω
Antenna Patch Size	25x25x4mm
Cable	1m RG174 standard, fully customizable
Connector	SMA(M), standard, fully customizable
LNA Electrical Properties	
Center Frequency $f_c$	GPS:1575.42±3 MHz GLONASS:1602±3 MHz
Impedance	50 Ω Nominal
VSWR	< 1.92:1
Return Loss	10 dB Min.
Gain	31 dB Min. @3.3V
DC Power Input	3.3V
Noise Figure @3.3V	1.5dB
Power Consumption	7~10mA

MECHANICAL	
Antenna Dimensions	58.15mm x 56.2mm x 16.8mm
Casing	UV Resistant ABS
Waterproof	IP65
O-Ring	Embedded for Waterproof
Weight	130g
Mounting	Magnetic
Magnetic Puling Force	Horizontal :1.07kgf      Vertical : 1.58kgf
ENVIRONMENTAL	
Operation Temperature	-40°C to 85°C
Storage Temperature	-40°C to 90°C
Humidity	Non-condensing 65°C 95% RH

### 3. GPS/GLONASS Antenna

#### 3.1 GPS/GLONASS Antenna Block Diagram

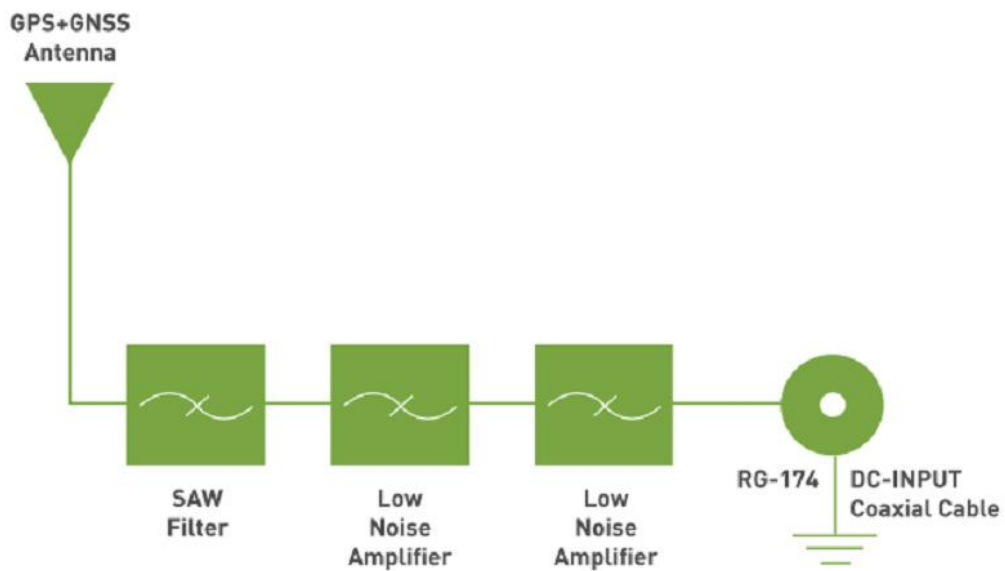

### 3.2 GPS/GLONASS Antenna Return Loss

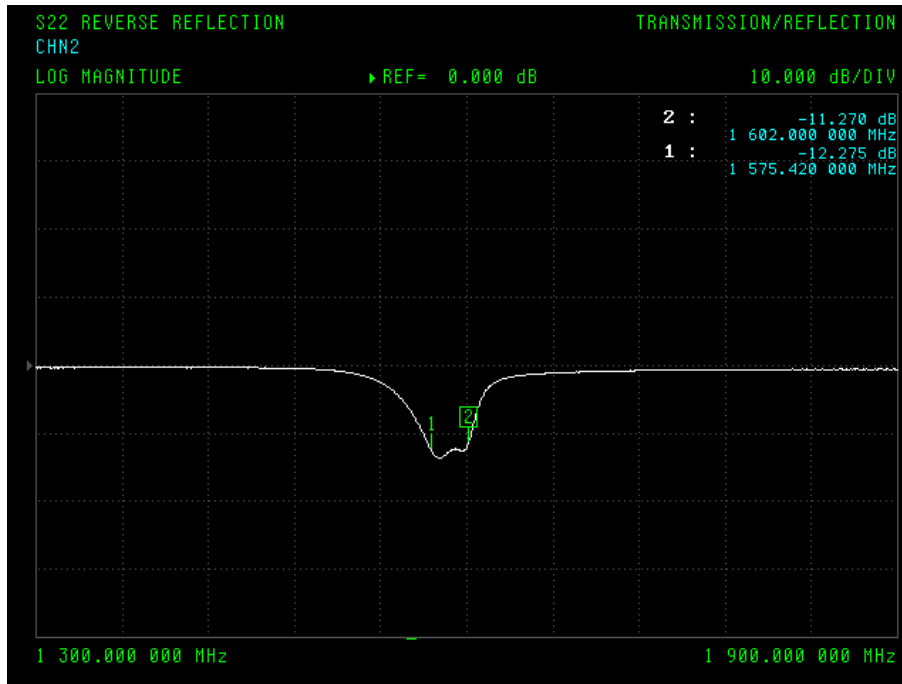

### 3.3 GPS/GLONASS Antenna Radiation Patterns



**1575.42MHz**

XZ Plane

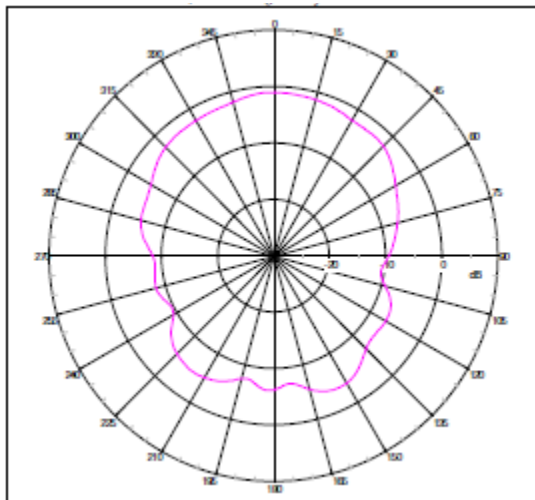

YZ Plane

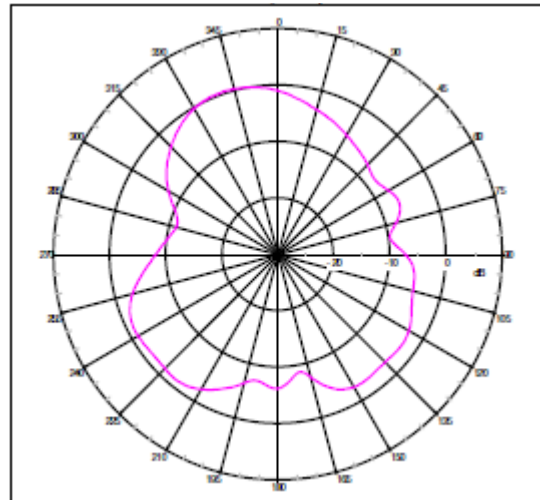

## 1602MHz

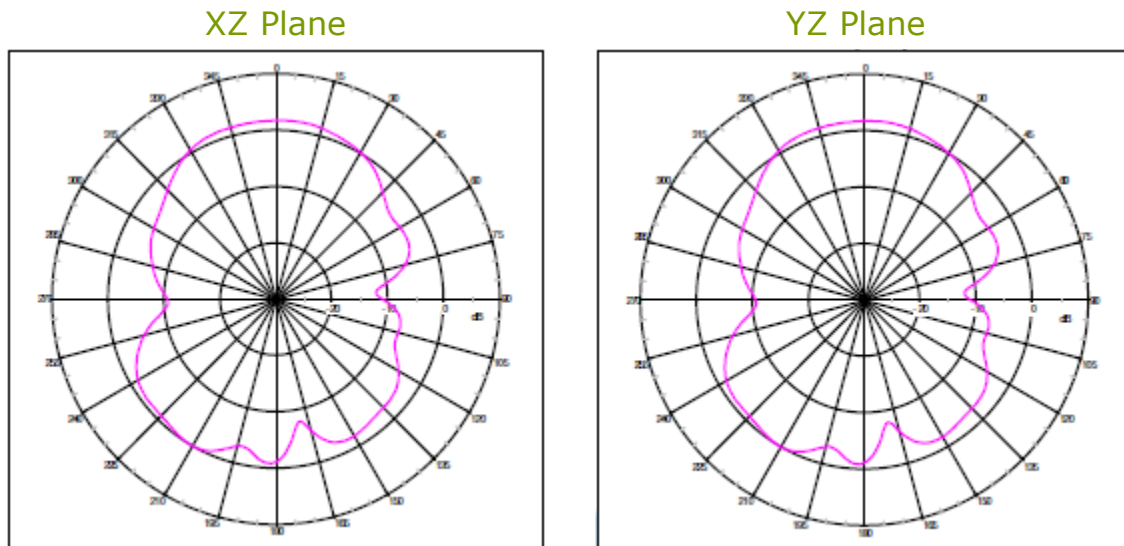

### 3.4 GPS/GLONASS Antenna Gain Chart

Frequency(MHz)	Gain @Zenith(dBic)	Efficiency (%)
1575.42	-0.2	40
1602	1.0	60



### 3.5 GPS/GLONASS LNA S21 & S22 Parameter Results

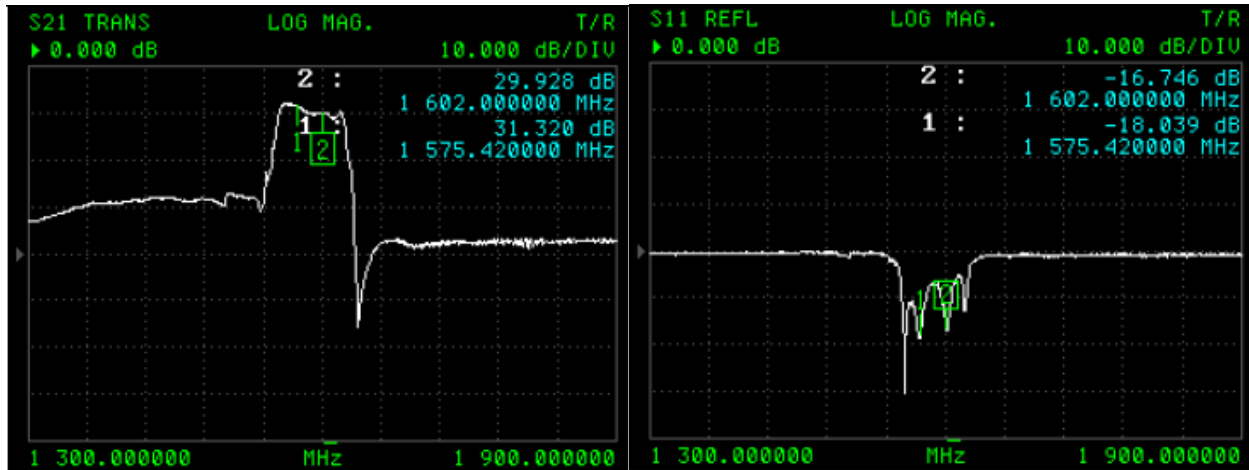

Test Item	Test Result
Gain @3.3V	31 dB@ 1575.42 MHz 29dB@1602MHz
Return Loss @3.3V	<-10dB
Noise Figure @3.3V	2.8 dB@ 1575.42 MHz 3.2dB@1602MHz
Current consumption @3.3V	7~10 mA

## 4. Cellular Antenna

### 4.1 Return Loss

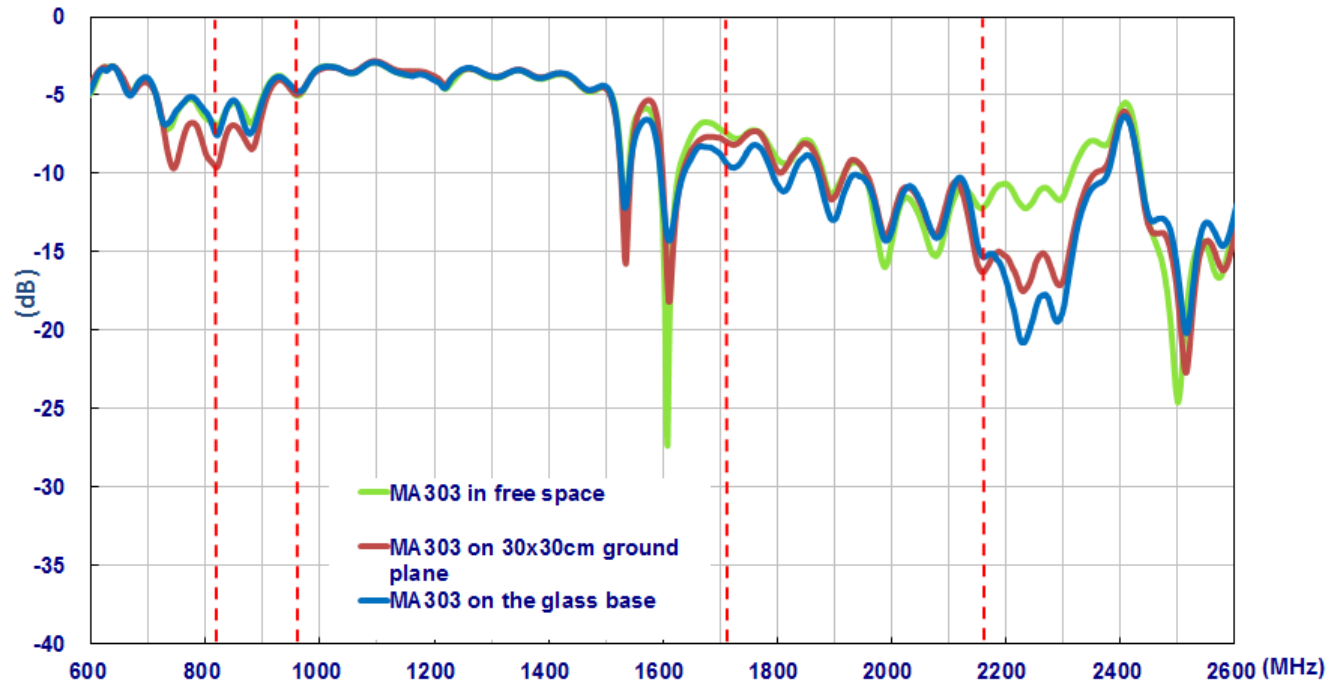

### 4.2 Efficiency

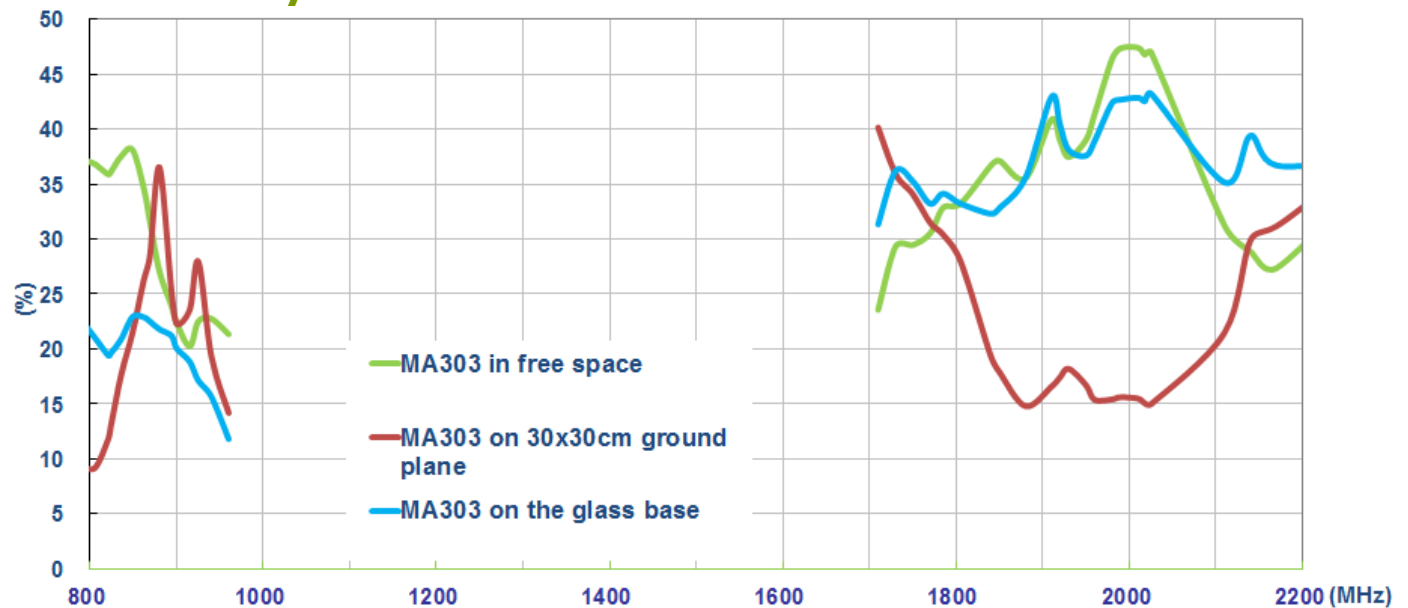

### 4.3 Peak Gain

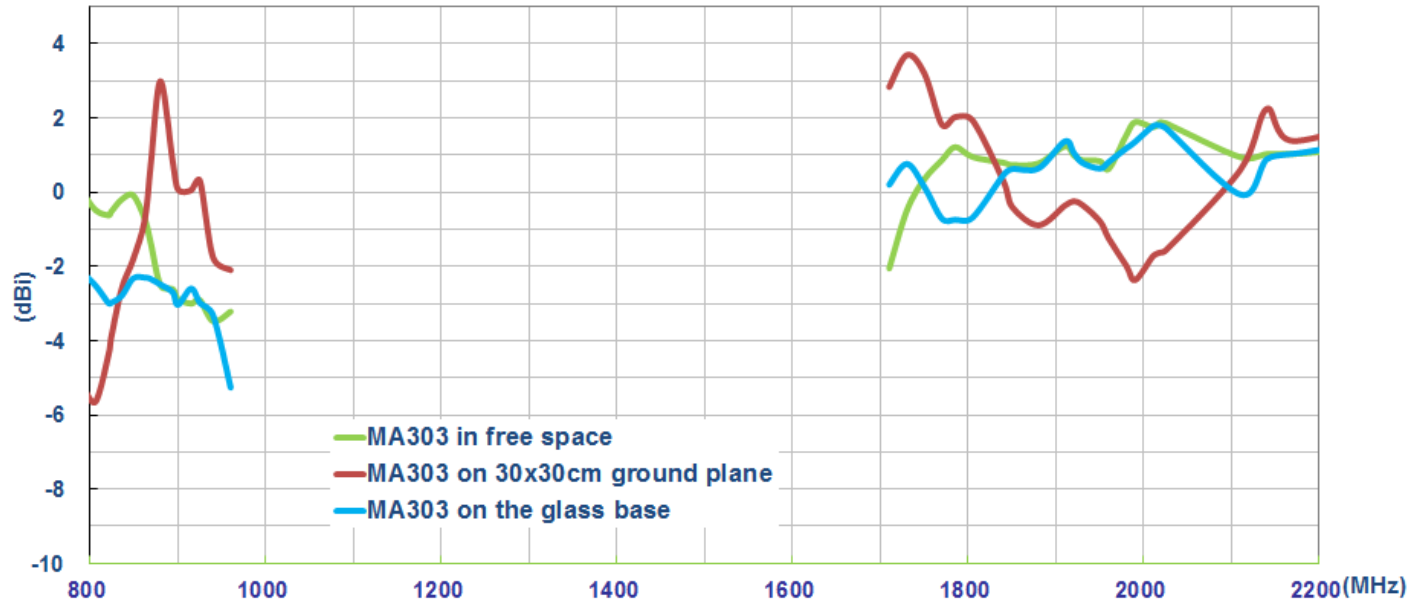

### 4.4 Average Gain

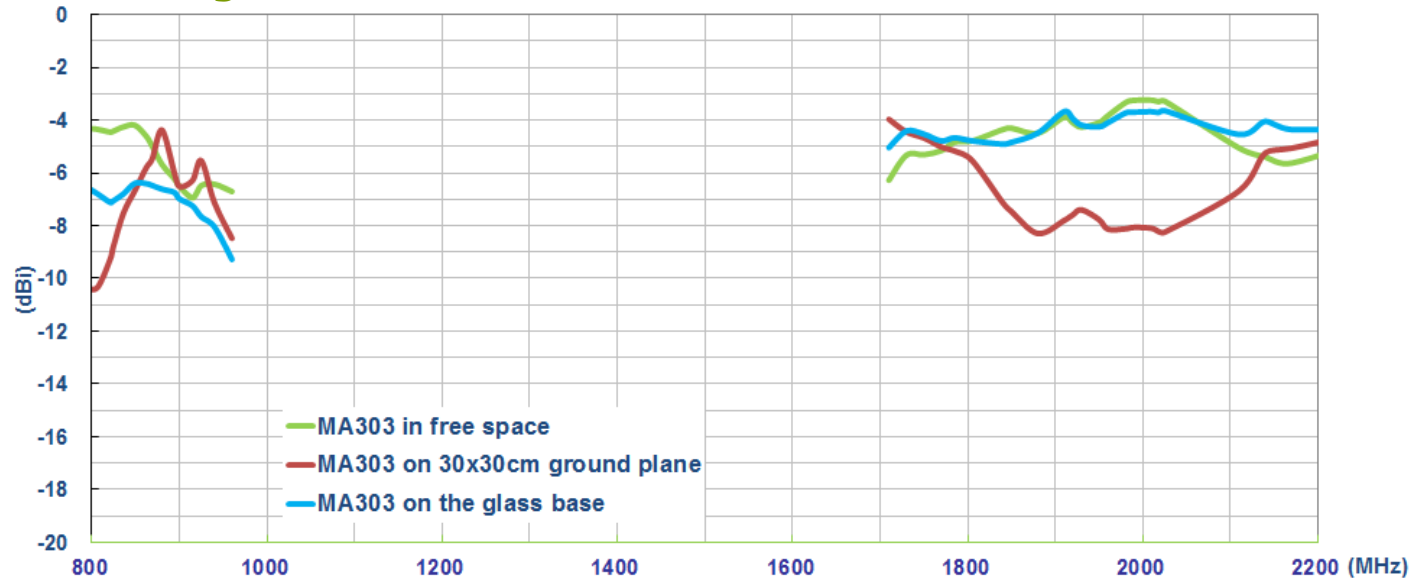

## 4.5 Measurement Setup

We measured the MA303 antenna in ETS Anechoic Chamber, there are three different measured methods as follows,

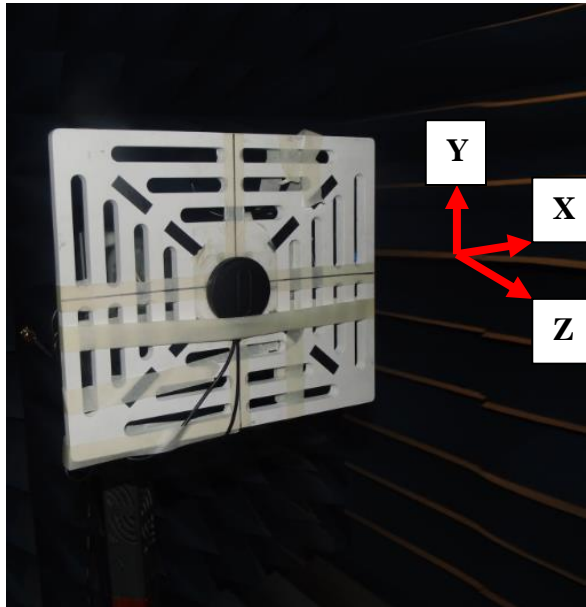

In Free Space

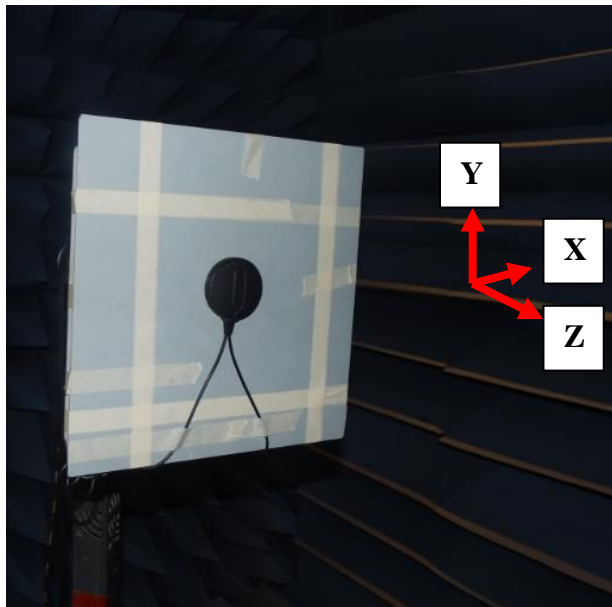

On 30cmX30cm Ground Plane

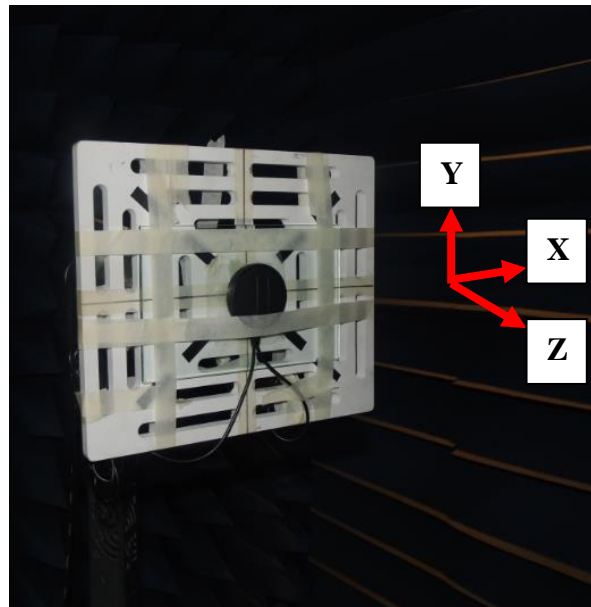

On the Glass Base

## 4.6 Radiation Pattern

In Free Space

XY-Plane

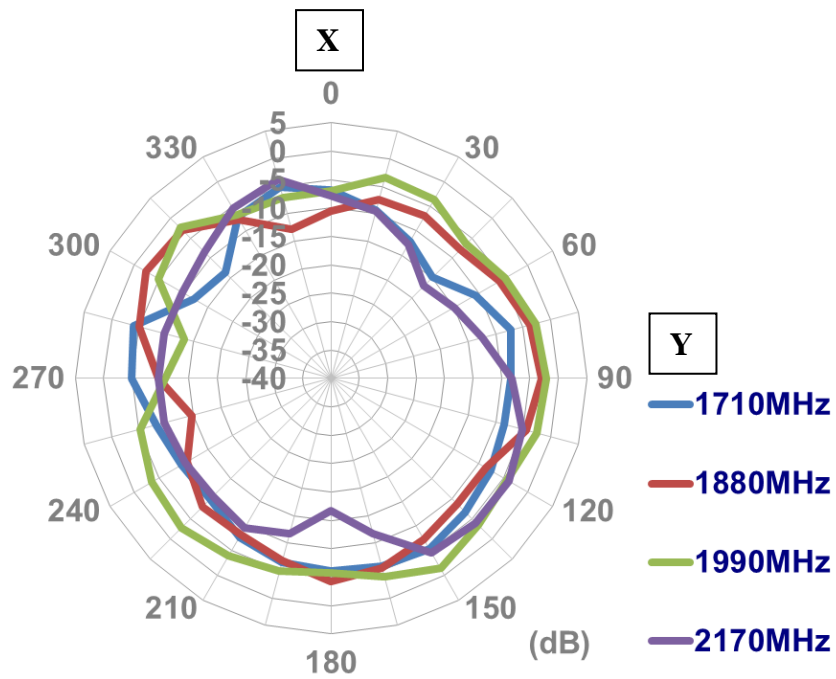
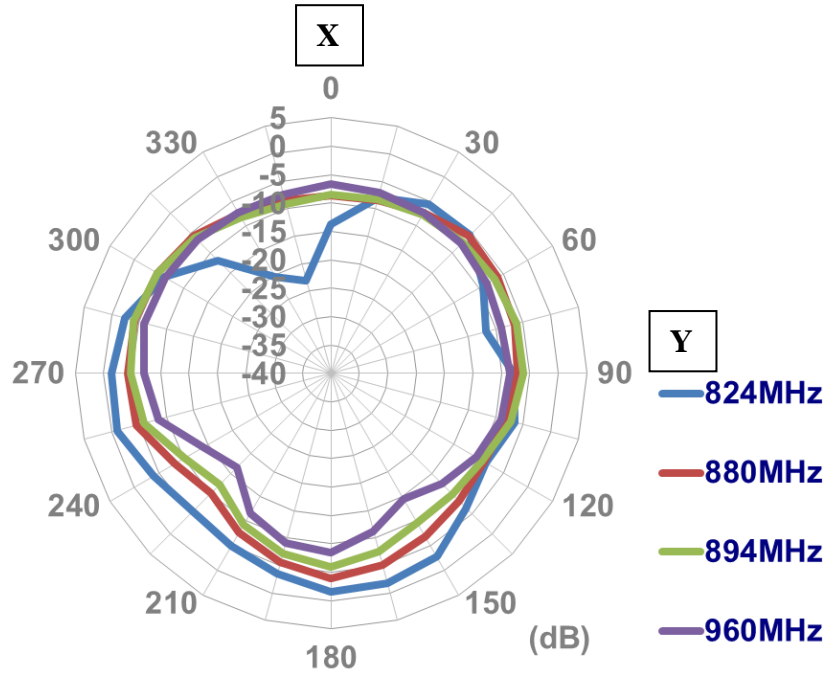

XZ-Plane

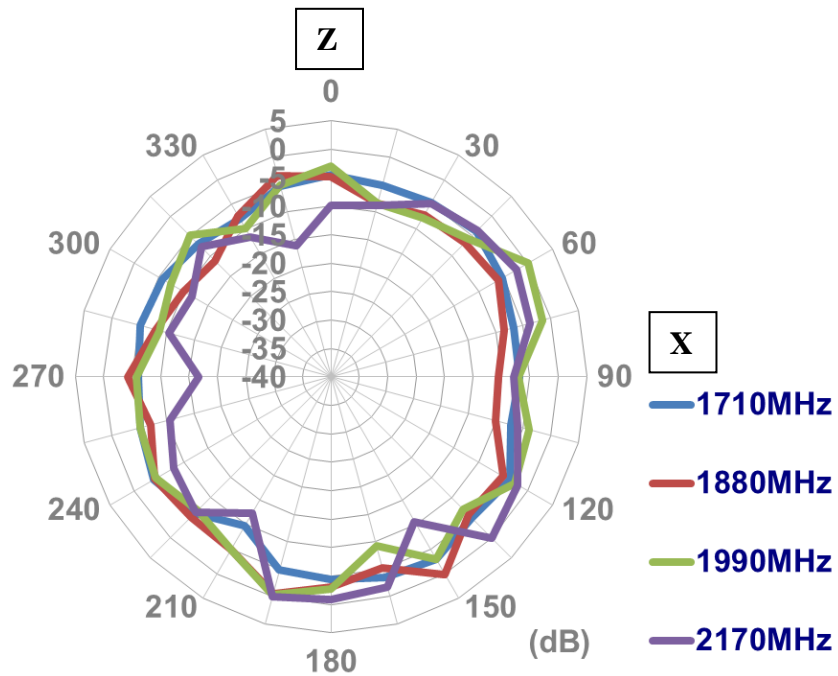
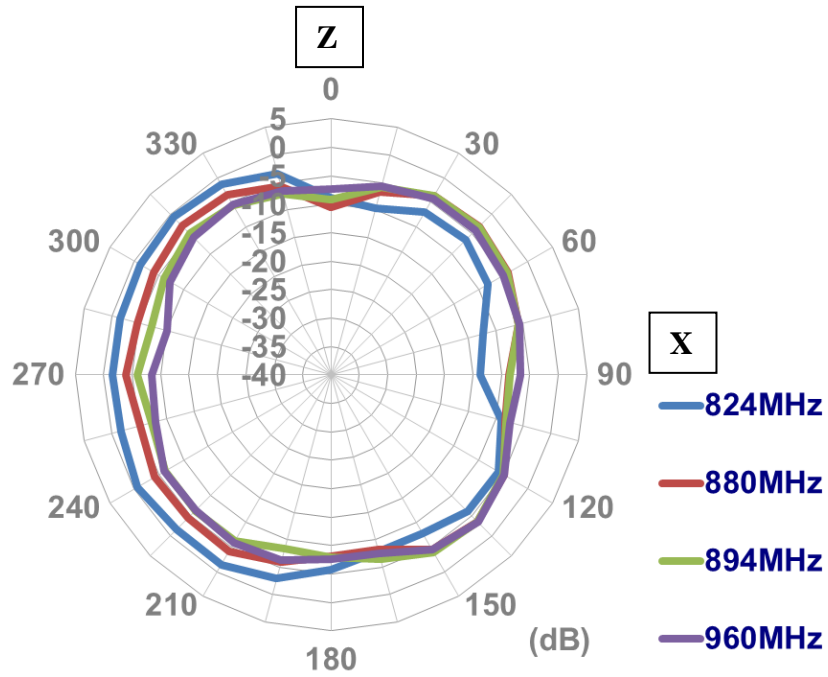

YZ-Plane

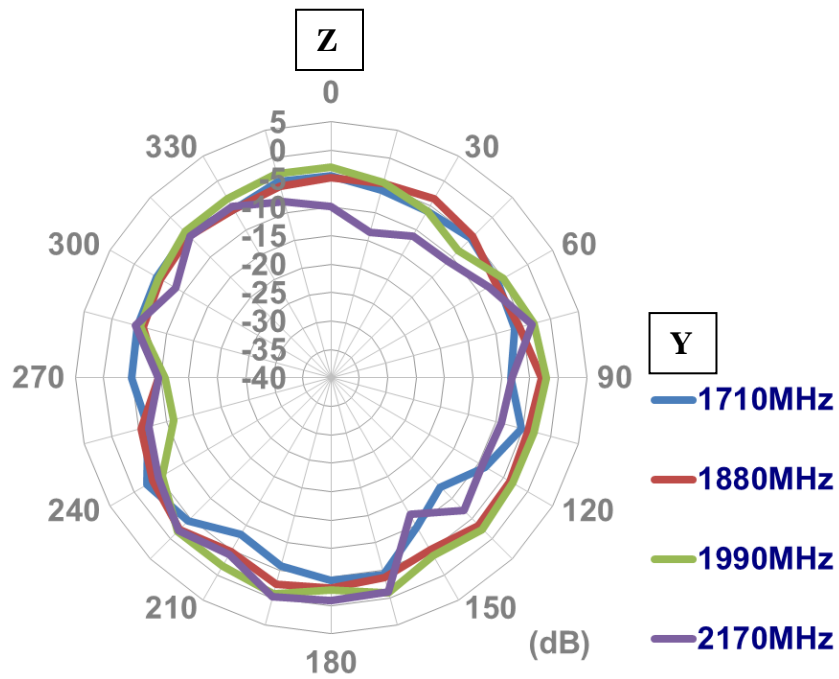
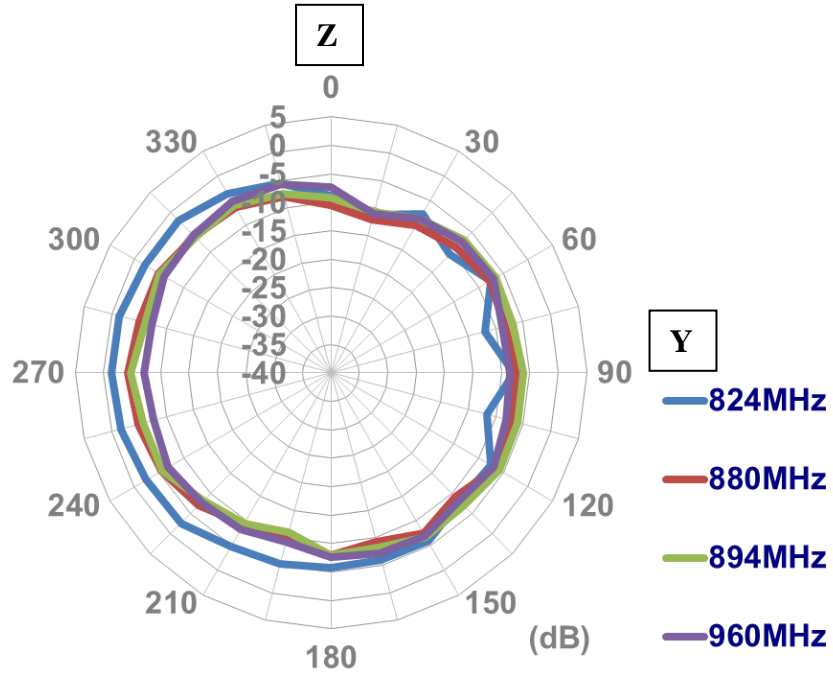

**On 30cmX30cm Ground Plane**  
XY-Plane

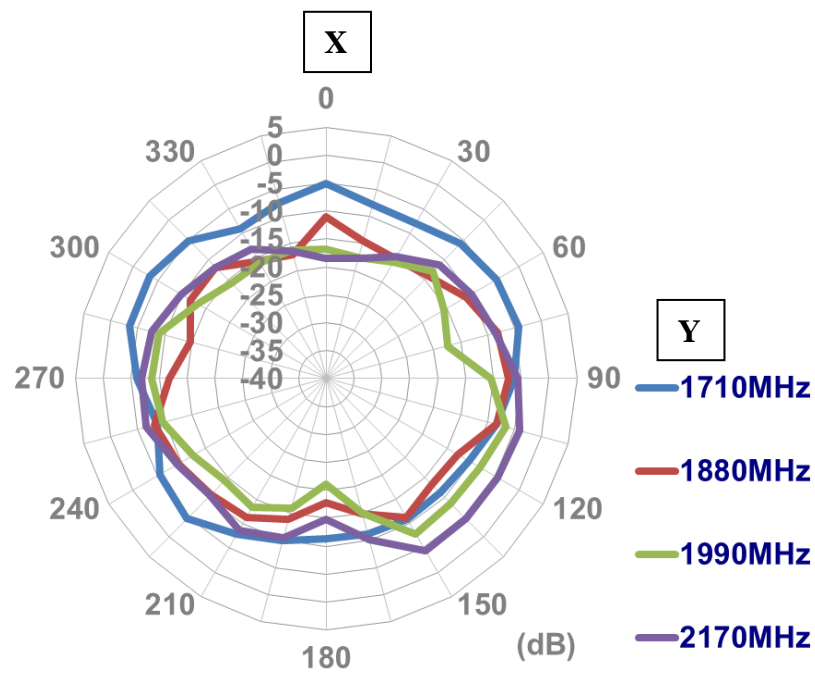
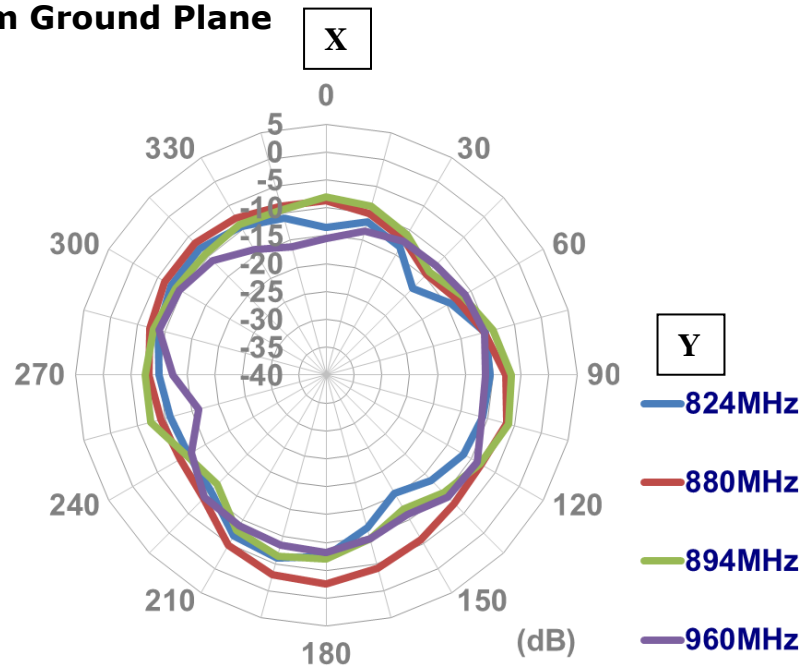



XZ-Plane

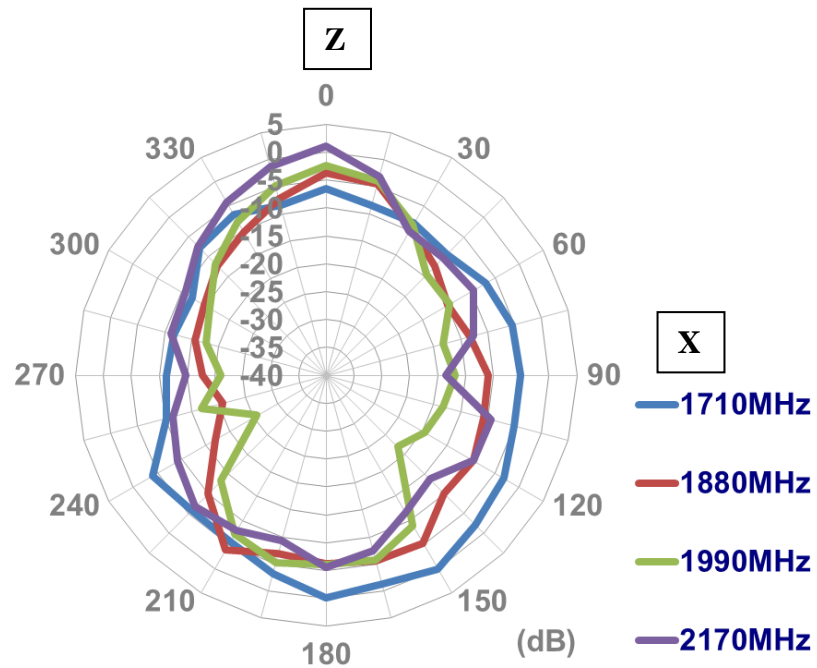
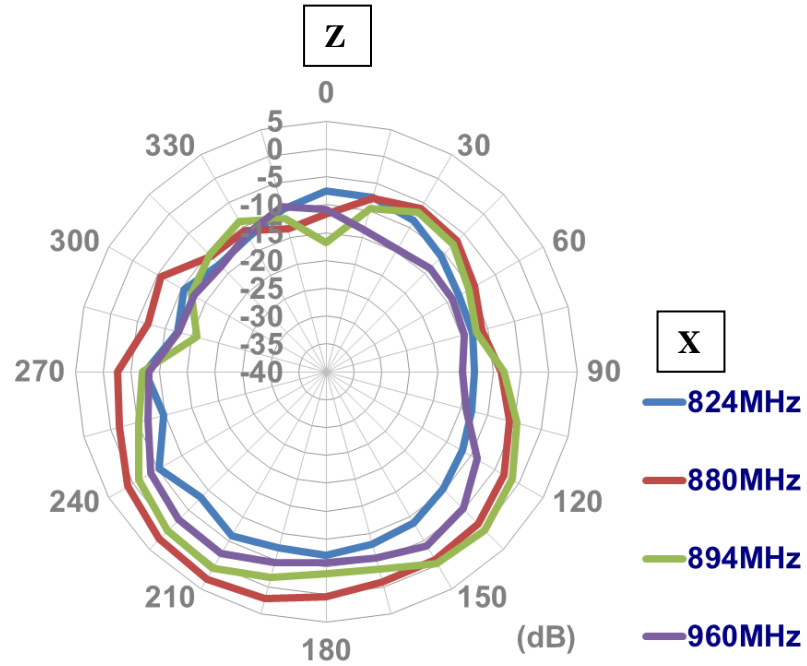

YZ-Plane

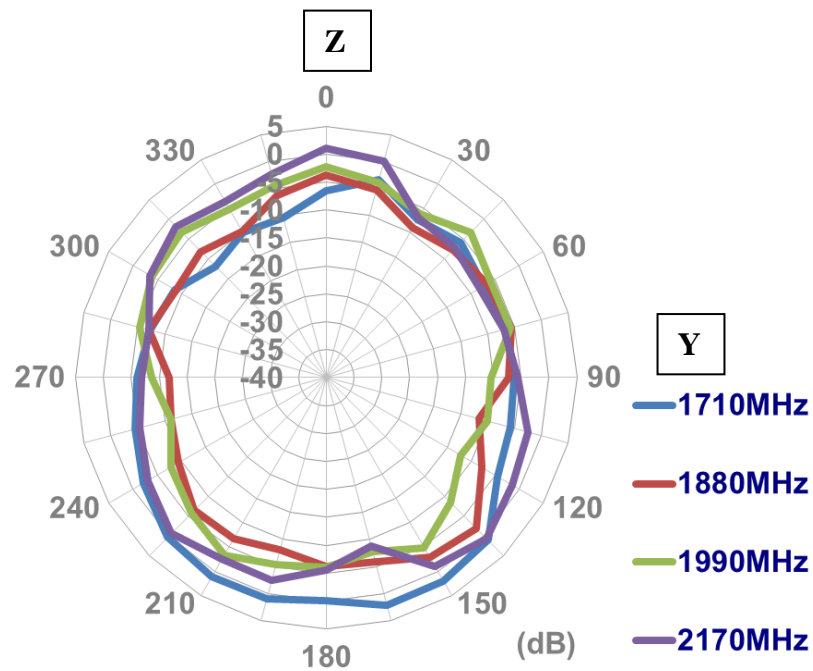
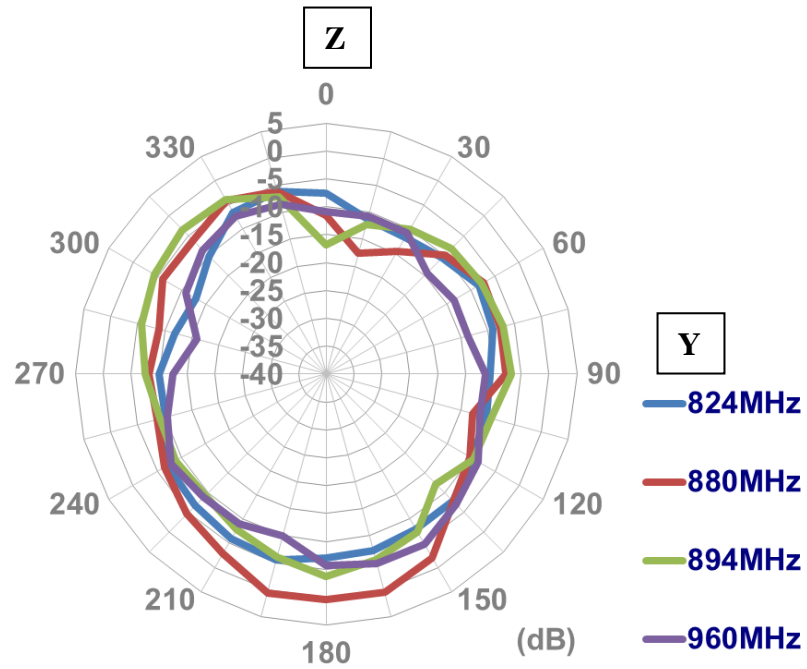

**On the Glass Base**  
XY-Plane

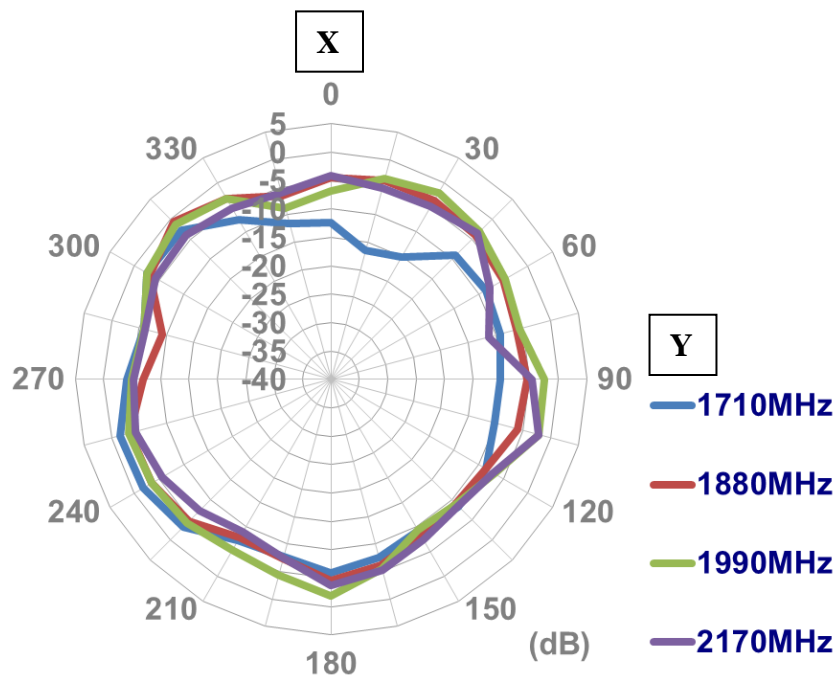
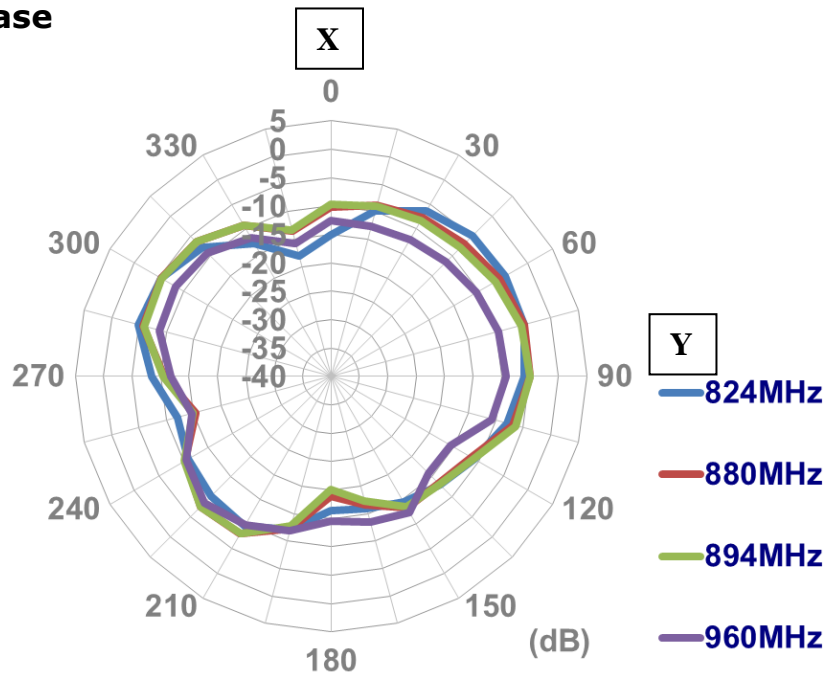

XZ-Plane

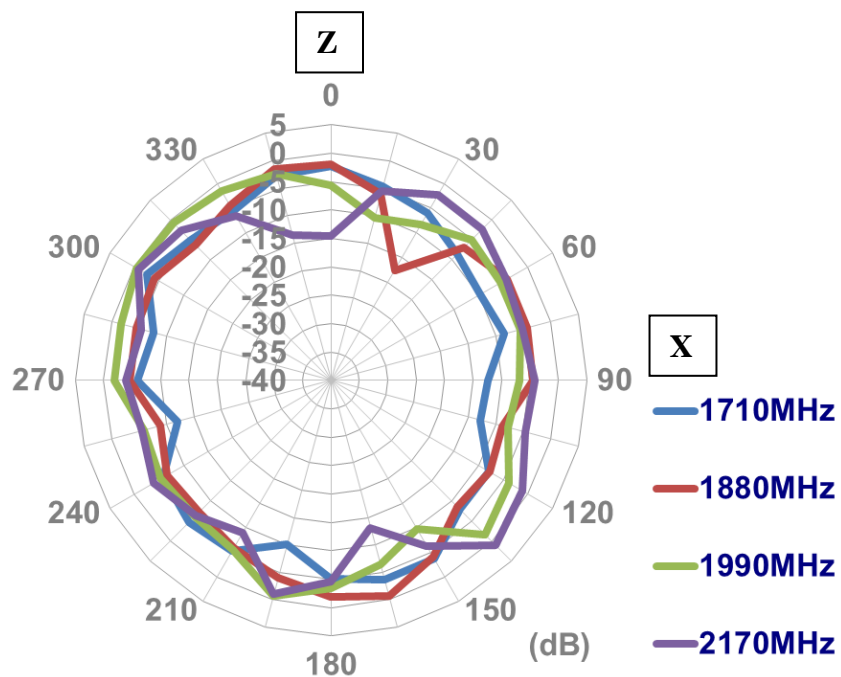
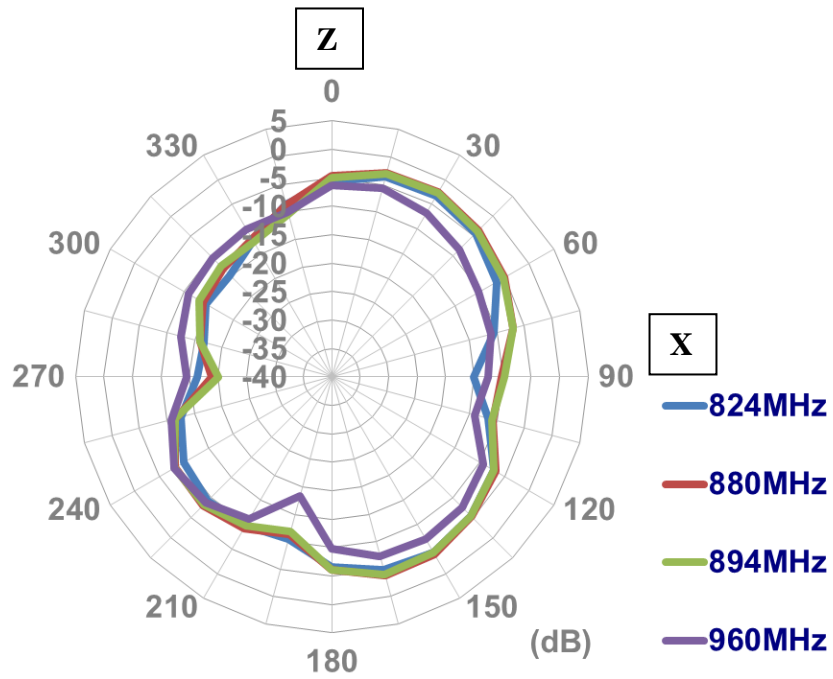

YZ-Plane

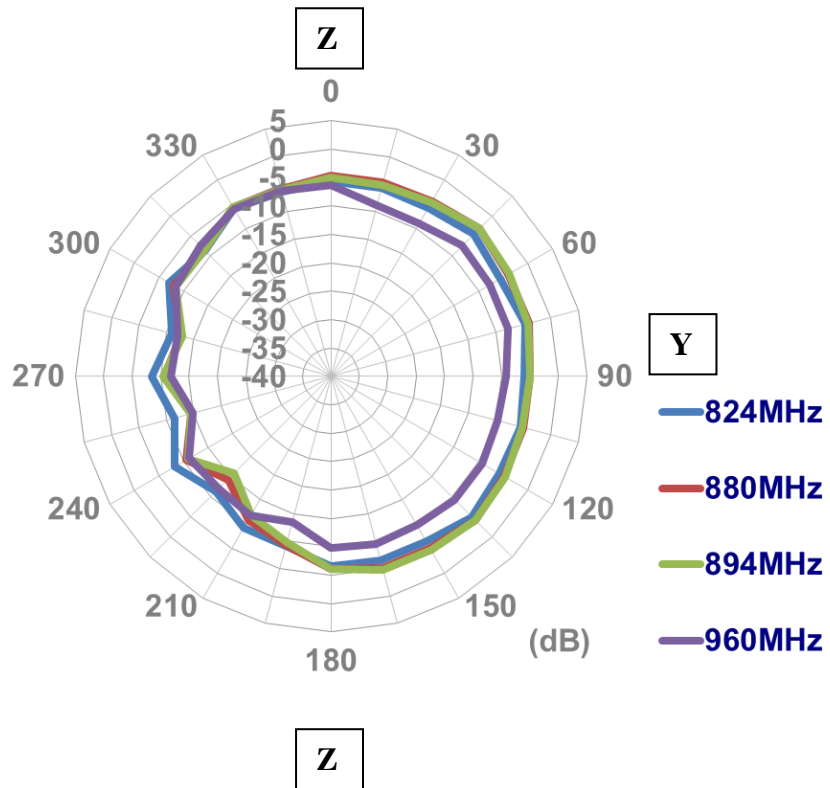

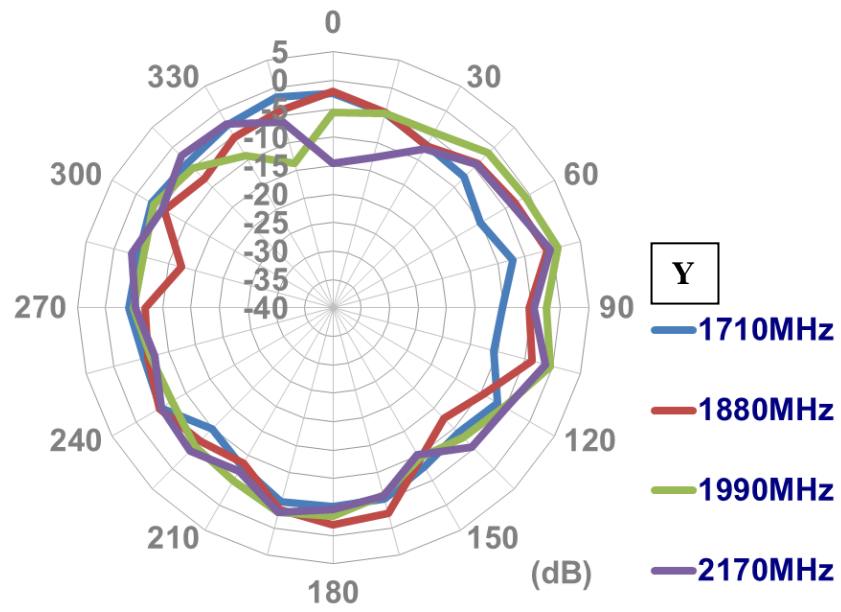

## 5. Drawing

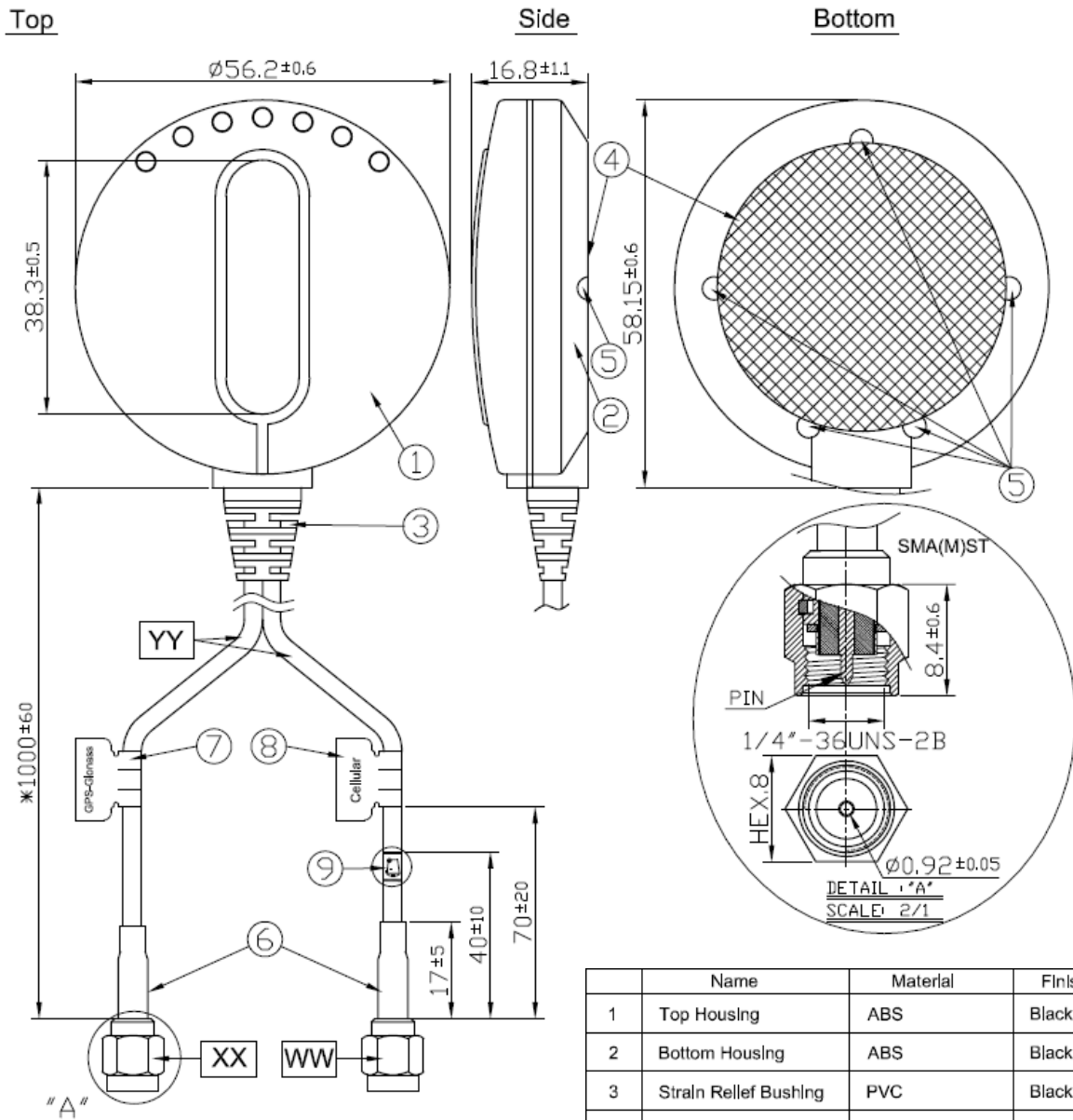

	Name	Spec	Finish	QTY
WW	Connector Type	SMA(M) ST	NI Plated	1
XX	Connector Type	SMA(M) ST(GPS)	Gold	1
YY	Cable Type	RG174	Black	2

	Name	Material	Finish	QTY
1	Top Housing	ABS	Black	1
2	Bottom Housing	ABS	Black	1
3	Strain Relief Bushing	PVC	Black	1
4	Blank Label	Matte Silver PET	Silver	1
5	2.6L Screw	Stainless Steel	Clear	5
6	Heat Shrink Tube	PE	Black	2
7	GPS-Glonass Label	Coated Paper	Orange	1
8	Cellular Label	Coated Paper	Blue	1
9	WEEE Heatshrink Tube	PE	White	1

## 5. Packaging

1 piece MA303 per PE Bag

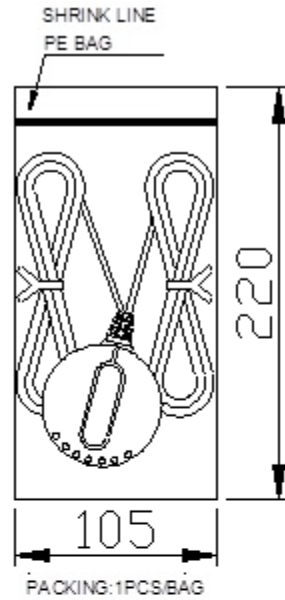
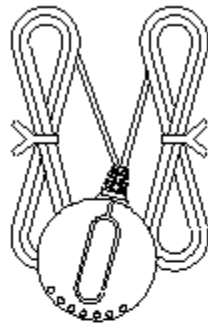

100 pieces per Carton

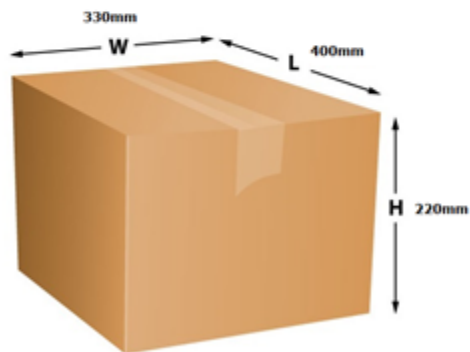



## 6. Magnetic Pulling Force

### 6.1 Testing Setup

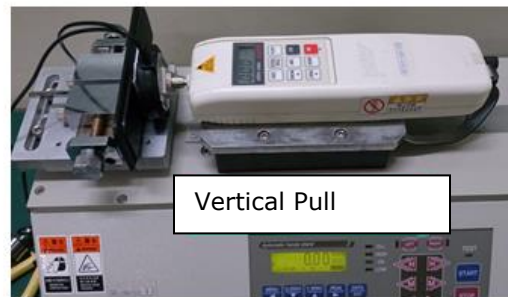

## 6.2 Testing Results

### 6.2.1 Horizontal Pull Force Magnetic Bond Break Test

Distance(mm)	0.5	1.0	1.5	2.0	2.5	3.0	3.5	4.0	4.5	5.0
Pulling force(Kgf)	0.10	0.17	0.28	0.33	0.38	0.40	0.47	0.58	0.68	0.77
Distance(mm)	5.5	6.0	6.5	7.1	7.5	8.0	8.5	9.0	9.5	10.0
Pulling force(Kgf)	0.82	0.89	0.98	1.07	0.94	0.94	0.94	0.93	0.96	0.95

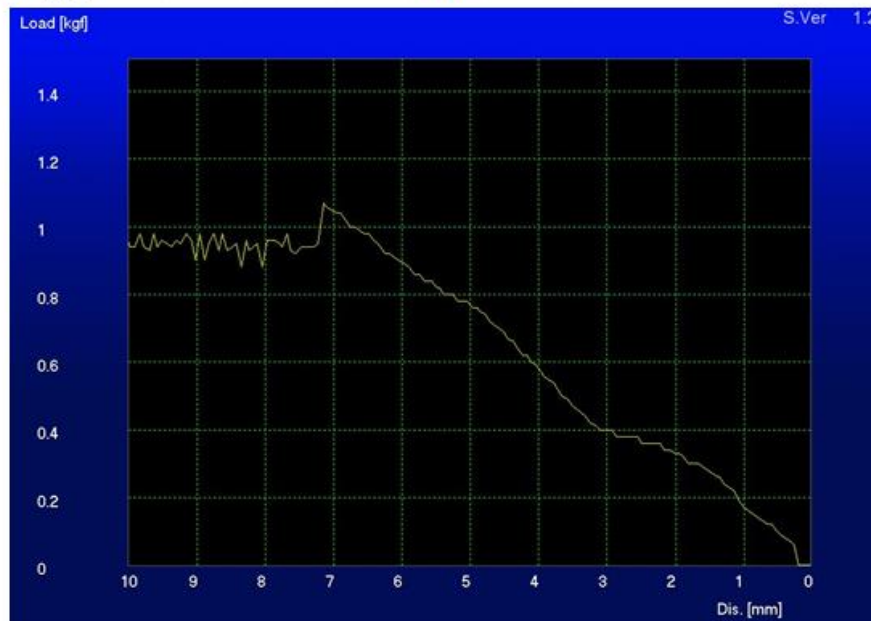

Maximum Force : 1.07kgf

### 6.2.2 Vertical Pull Force Magnetic Bond Break Test

Distance(mm)	0.5	1.0	1.5	2.1	2.5	3.0	3.5	4.0	4.5	5.0
Pulling force(Kgf)	0.47	0.72	1.19	1.58	1.50	1.45	0.62	0.47	0.38	0.34
Distance(mm)	5.5	6.0	6.5	7.0	7.5	8.0	8.5	9.0	9.5	10.0
Pulling force(Kgf)	0.30	0.28	0.26	0.26	0.24	0.23	0.22	0.22	0.22	0.22

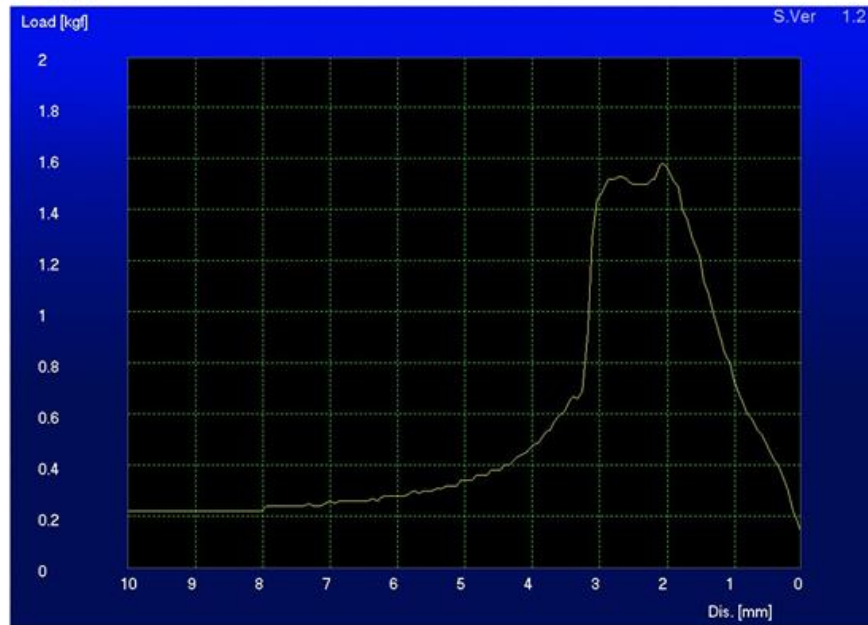

Maximum Force : 1.58kgf