

## Specification

- Part No. : **MA204.A.LB.002**
- Product Name : Stingray 2in1 GPS/GLONASS/GALILEO and Cellular Adhesive Antenna
- Features : GPS/GLONASS/GALILEO - High gain LNA up to 28dB

Penta-band Cellular – 800MHz to 2200MHz  
GSM/CDMA/PCS/DCS/UMTS/GPRS/EDGE/HSPA  
Adhesive antenna  
Height 10.8mm Diameter 55.1mm  
RoHS Compliant



## 1. Introduction

This is a 2in1 combination high performance GPS/GLONASS/GALILEO and Penta-band Cellular (GSM /CDMA/PCS/DCS/ / UMTS / GPRS / EDGE / HSPA) antenna to simplify AVL or Fleet management antenna systems worldwide. Its high quality low profile covert housing can be attached onto the glass or even out of sight under the dashboard. This combination of a high gain GPS/GLONASS/GALILEO antenna and a leading edge penta band cellular antenna is ideal for those applications that require durability, small size and covert installation, and reliable reception and transmission crossing through different mobile networks.

The standard version has 3 metres RG174 cable and SMA(M) connector on both GPS/GLONASS/GALILEO and Cellular. The cables and connectors are completely customizable according to customer request.

### Features

#### **GPS/GLONASS /GALILEO**

- High LNA Gain up to 28 dB
- Antenna Gain  $28 \pm 2$  dB
- Miniaturized to 55\*11.8mm
- Low Noise 2.2 dB max

#### **Cellular**

- Advanced penta-band cellular antenna  
(GSM/CDMA/PCS/DCS/UMTS/GPRS/EDGE/ HSPA)

#### **Other**

- Water Resistant IP 65
- Quality textured covert design. Low profile
- UV resistant ABS housing
- Comes with high grade 3M double sided tape for quick and easy mounting
- Customizable cables and connector

## 2. Antenna Block Diagram

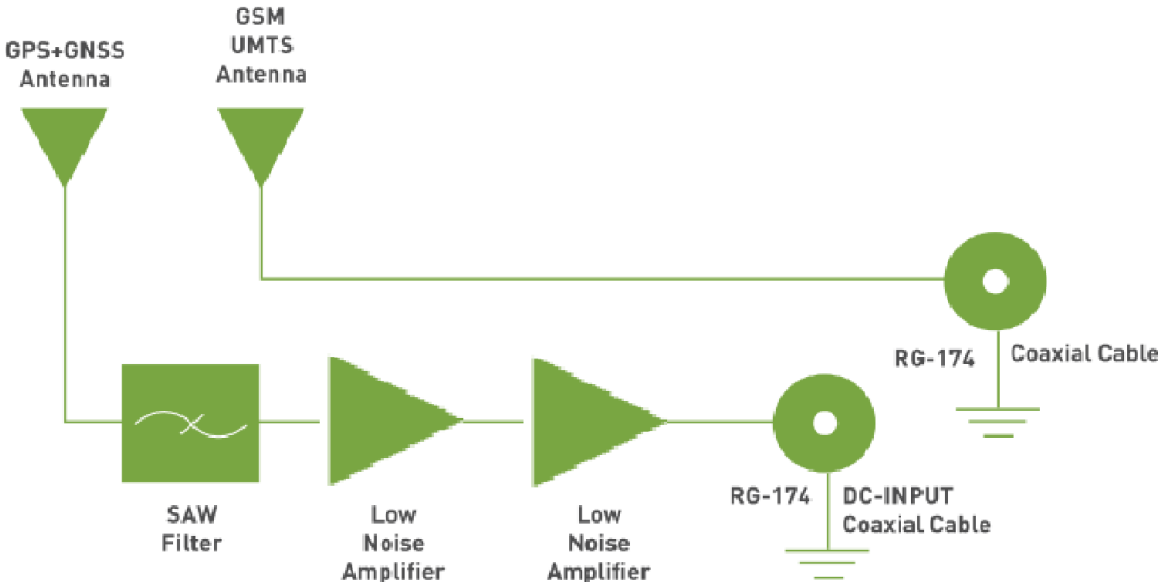

### 3. Specification

Performance Specifications		
Items	GPS/GLONASS/GALILEO Antenna	Cellular Antenna
Features	High performance GPS/GLONASS/GALILEO ceramic patch antenna with cutting edge low noise amplifier	800MHz to 2200MHz
Frequency	1575.42 MHz ± 3MHz 1602 MHz ± 0.5MHz	As above
Gain	28 dB typ.	As patterns
VSWR	2.0:1	2.5:1
Impedance	50Ω	50Ω
DC Power Input	3.3V	-
Power Consumption	10mA Typ.	
Noise Figure	2.2 dB Max	-
Cable / Connector	Standard 1/2/3/5m RG-174 Cables and Connectors Fully Customizable	Standard 1/2/3/5m RG-174 Cables and Connectors Fully Customizable
Operating Temperature	-40°C ~ +85°C	-40°C ~ +85°C
Storage Temperature	-40°C ~ +95°C	-40°C ~ +95°C
Size	55mm * 10.8mm	
Housing	UV resistant ABS	

**\*note: specifications may be subject to change**

## 4. GPS/GLONASS/GALILEO Antenna -Setup

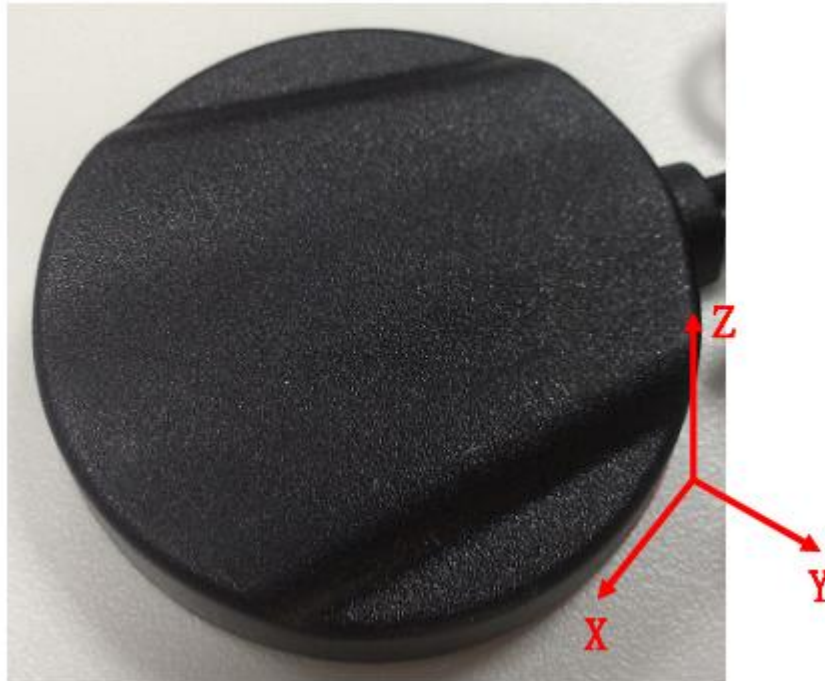

## 4.1 GPS/GLONASS/GALILEO Antenna

### 4.1.1 Smith Chart – Impedance

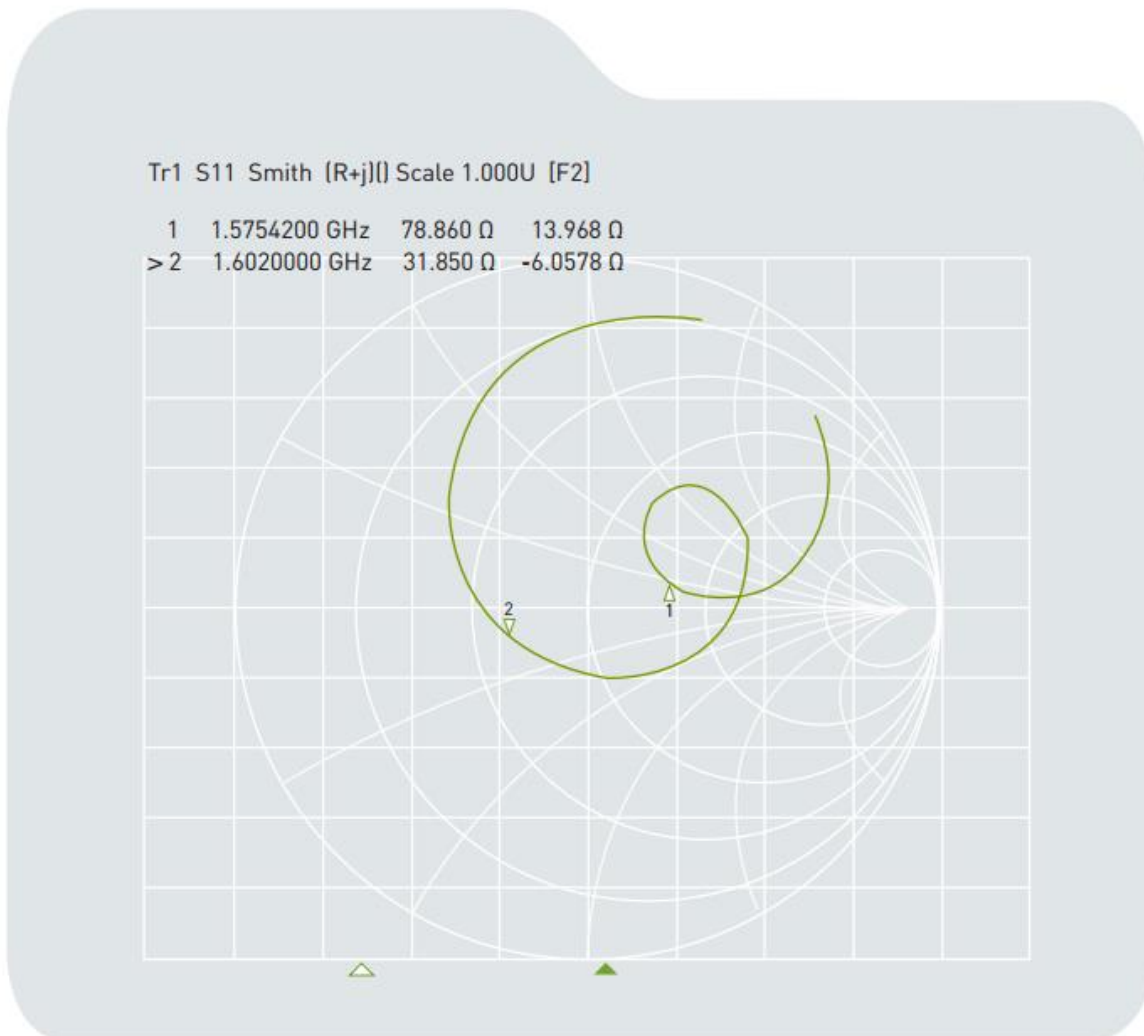

4.1.2 VSWR

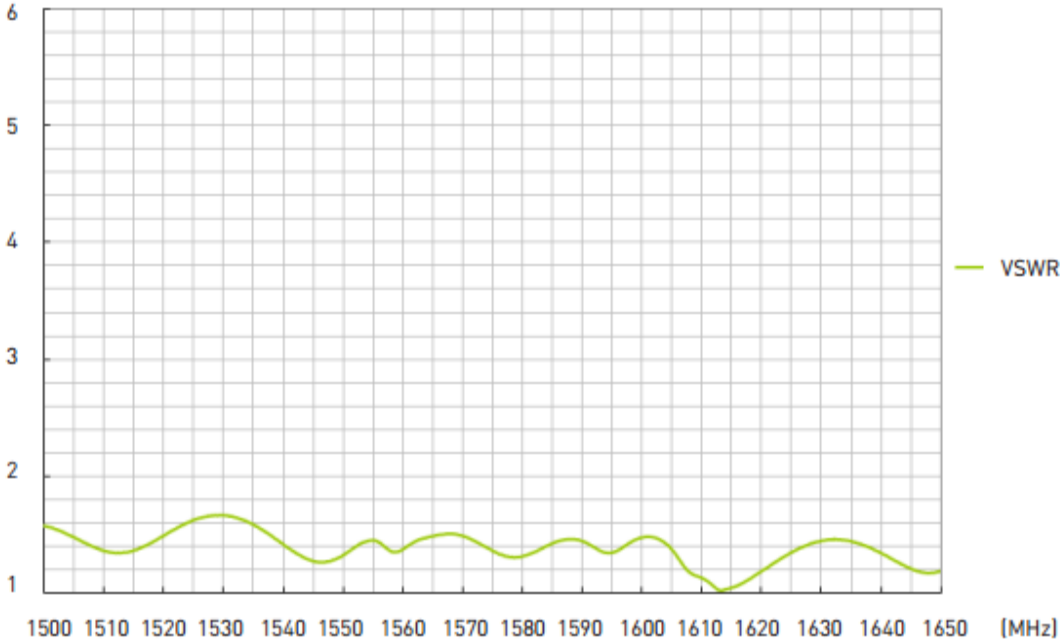

4.1.3 Return loss

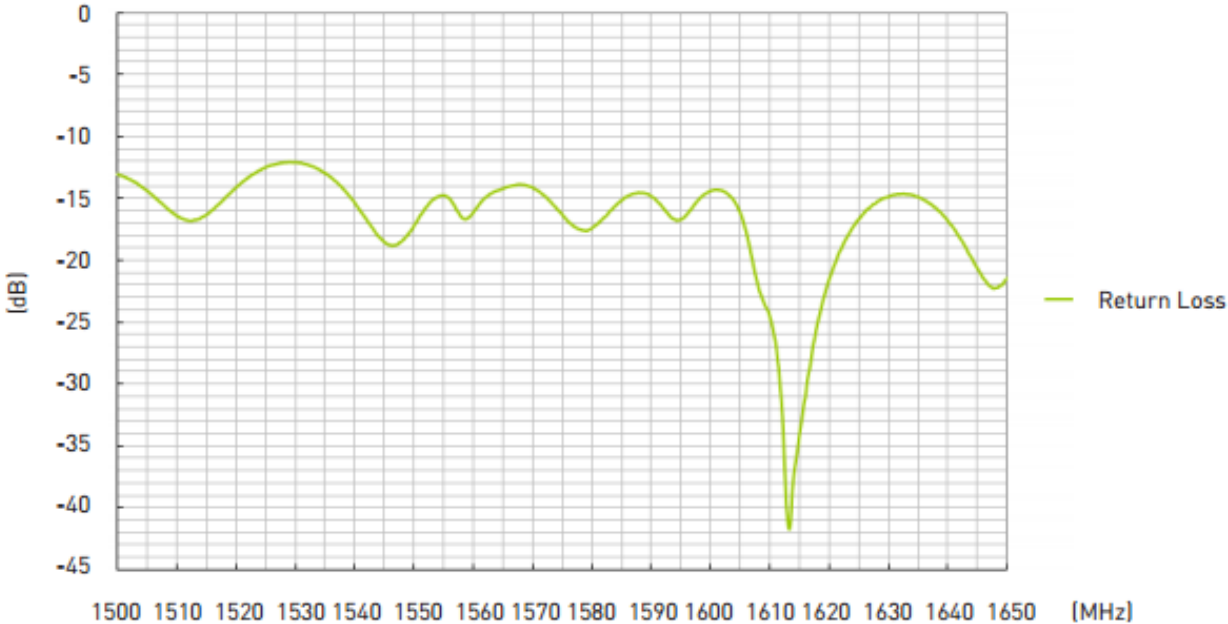

## 4.2 GPS/GLONASS/GALILEO Antenna Radiation Patterns 1575MHz

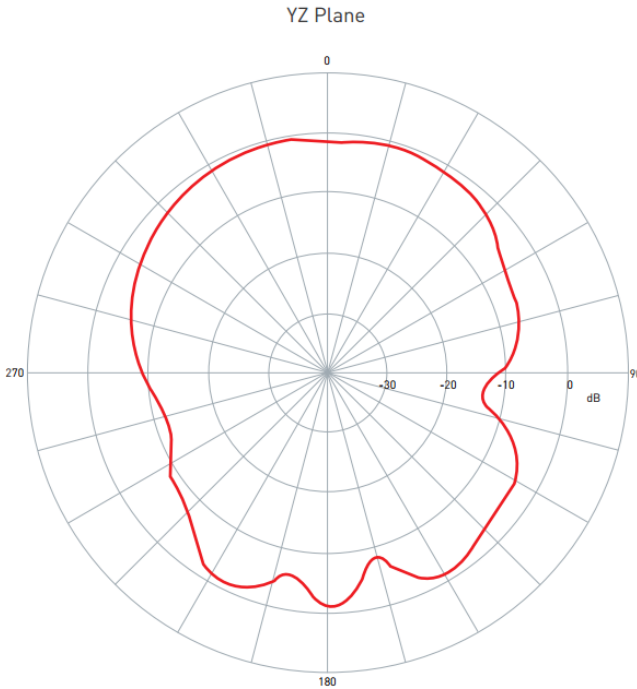
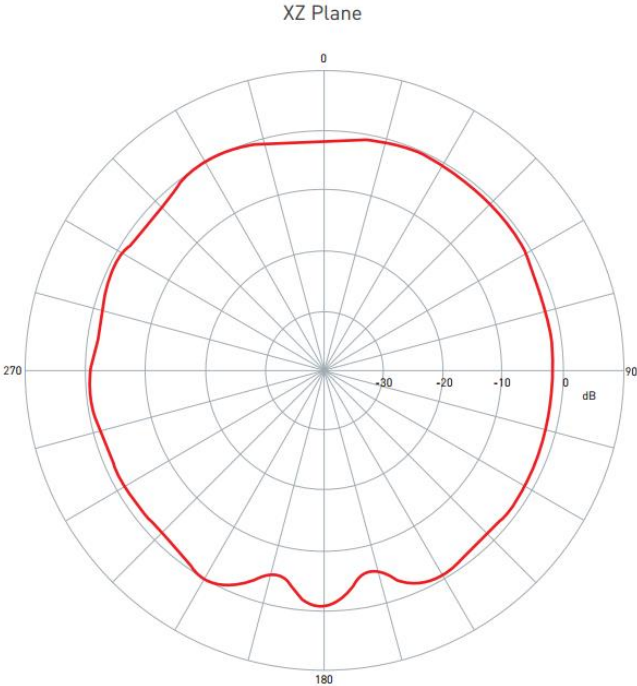



1602MHz

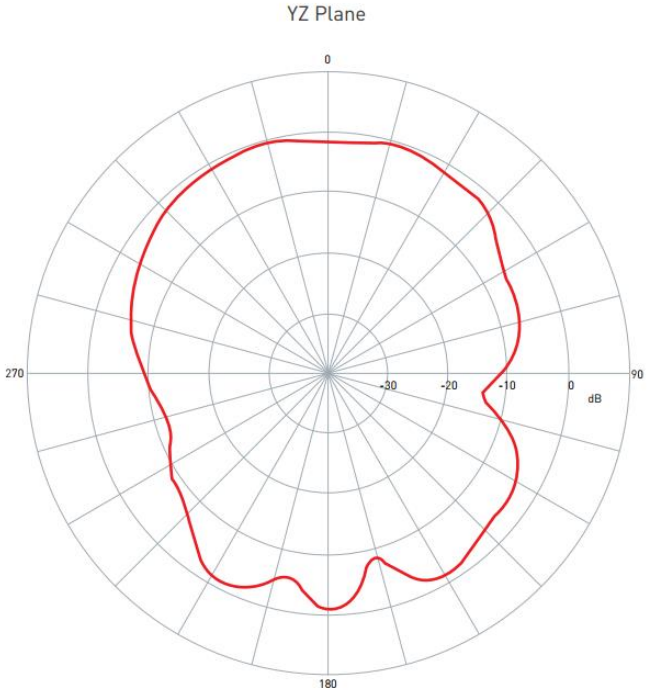
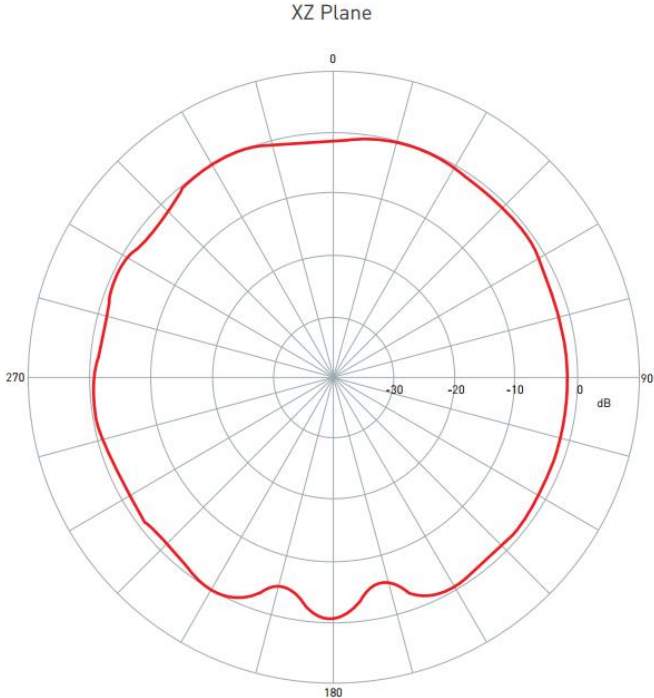

**4.3 GPS/GLONASS/GALILEO Antenna Gain Chart**

Frequency(MHz)	Peak Gain(dBi)	Efficiency(%)
1575	1.36	50.13
1602	0.09	52.64

**4.4 GPS/GLONASS/GALILEO LNA Gain**

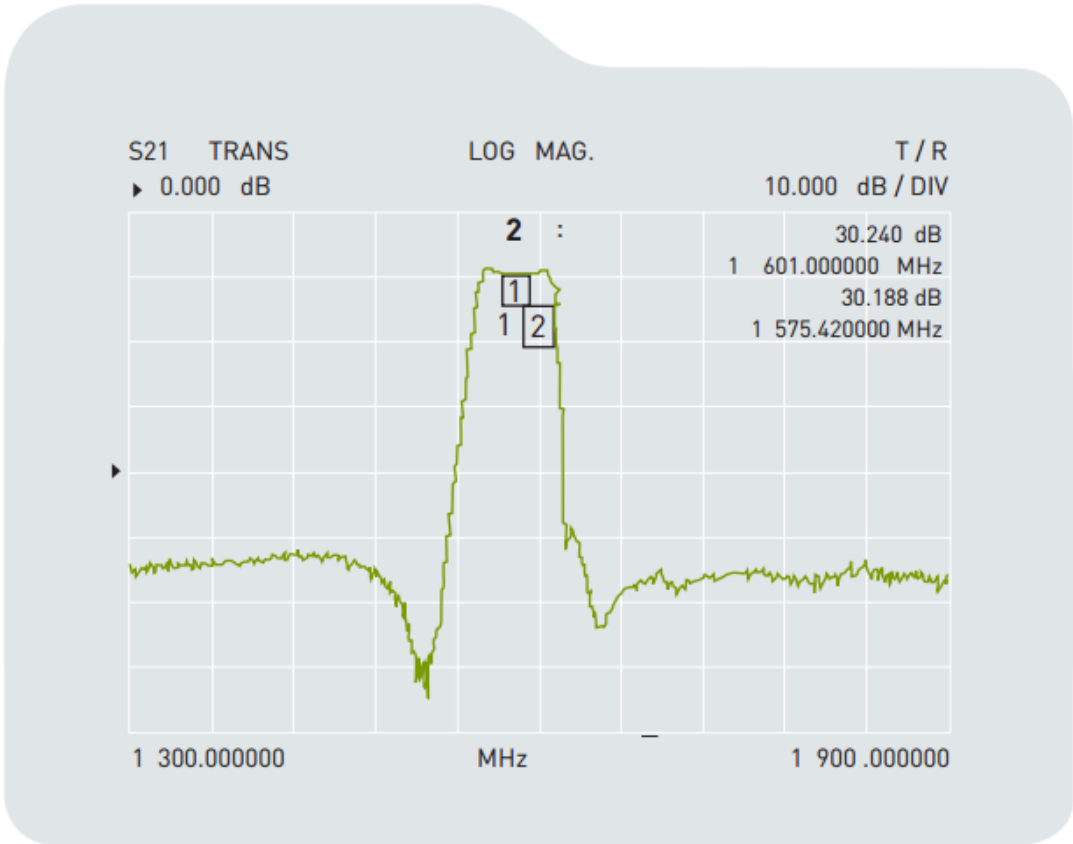

**4.5 GPS/GLONASS/GALILEO LNA Output Return Loss**

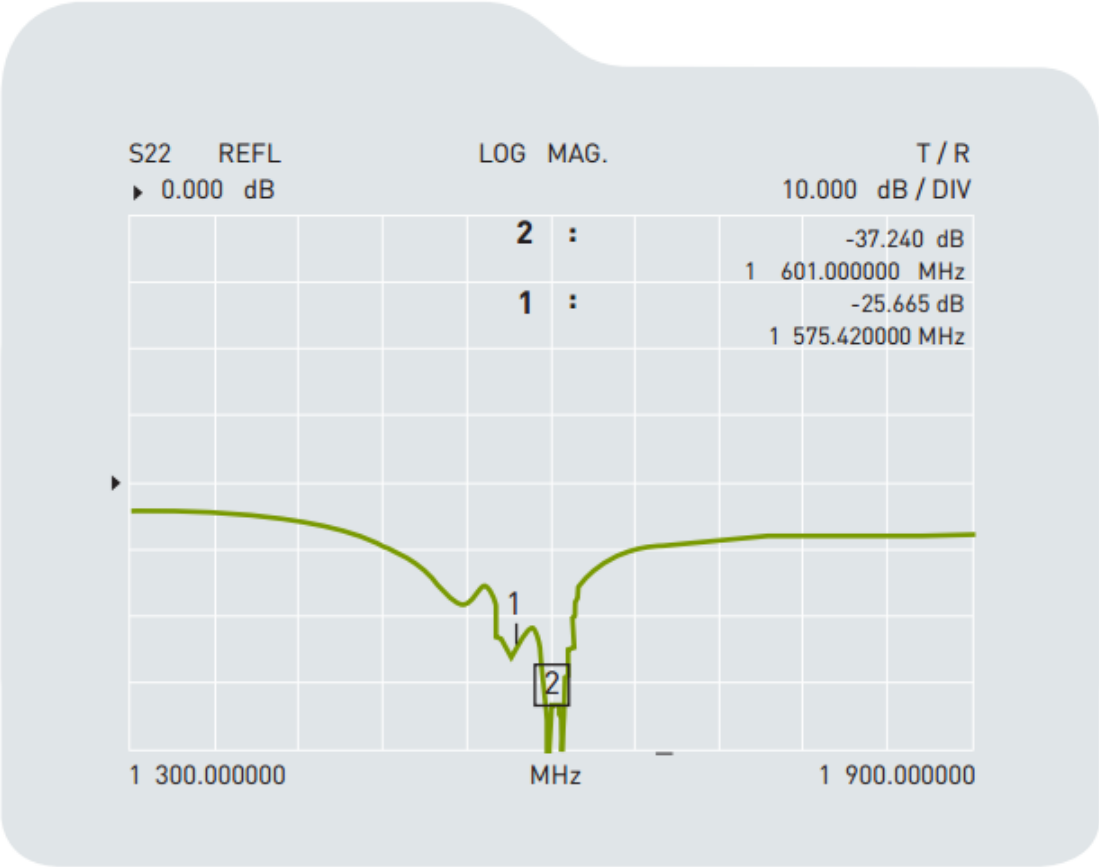

## 5. Cellular Antenna

With Housing, Free Space, ABS & Glass Mount (RG-174, length = 3M)

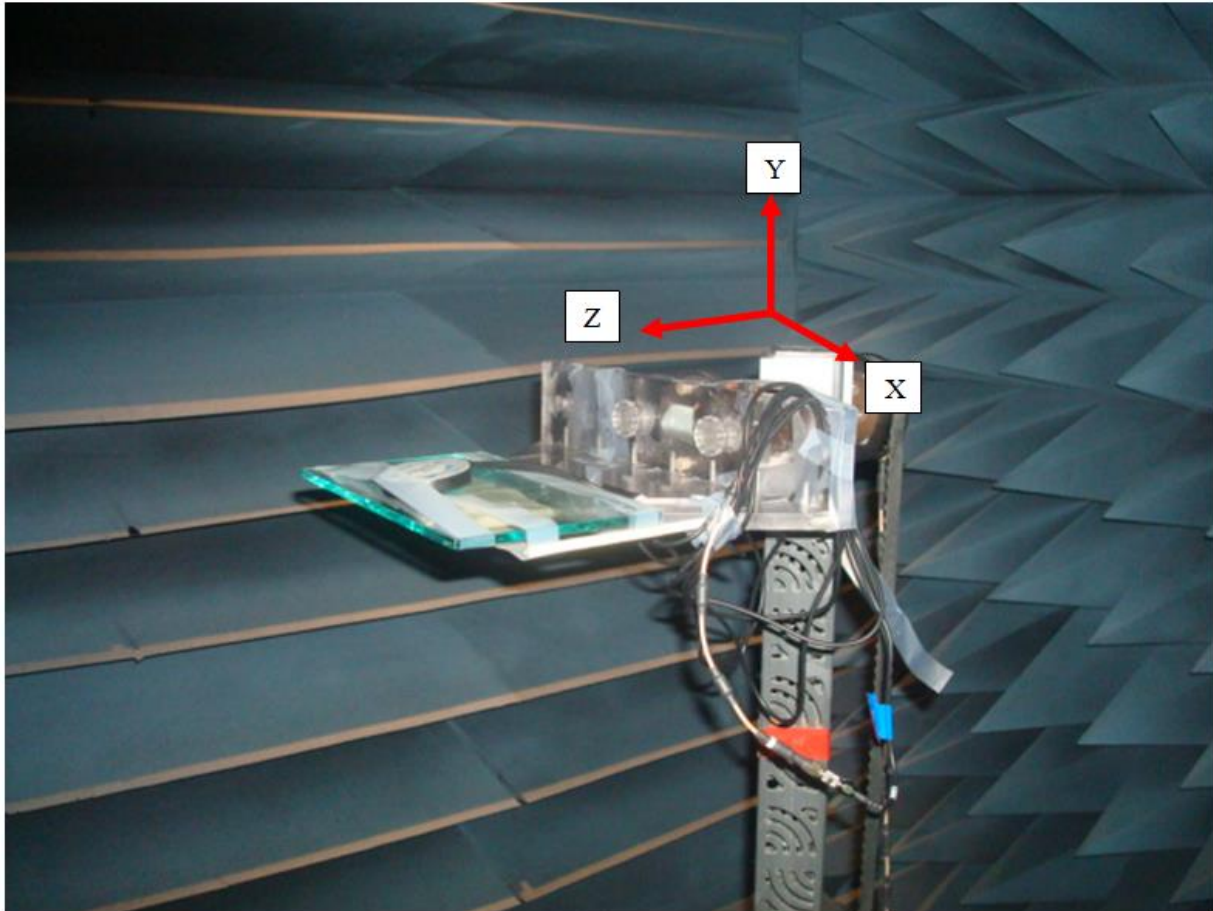

### 5.1 Return Loss

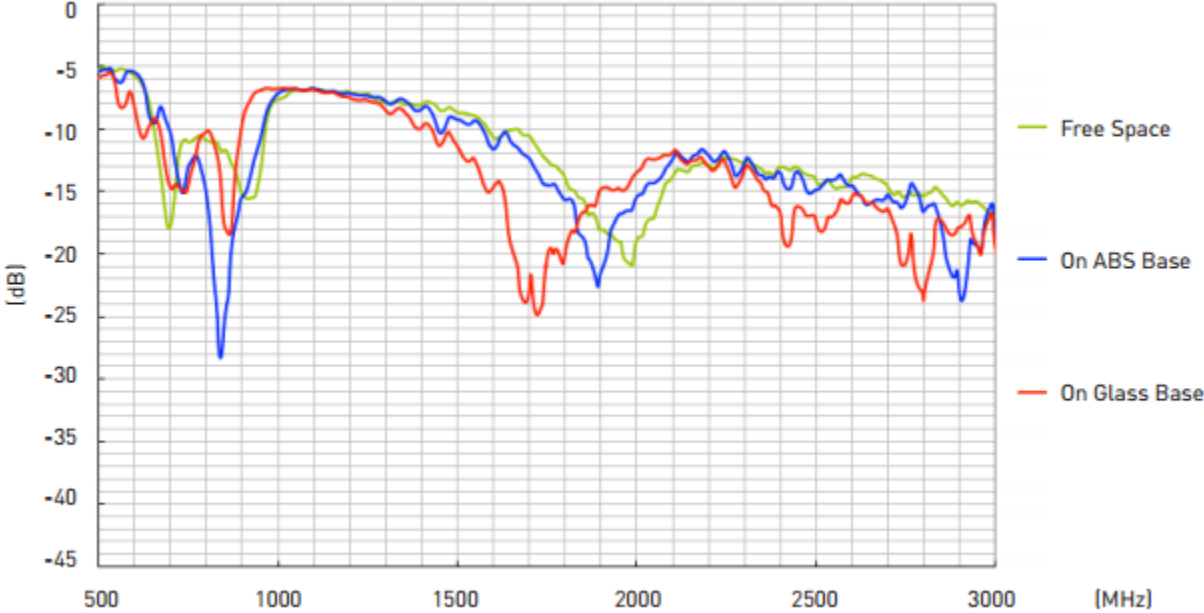

### 5.2 Efficiency

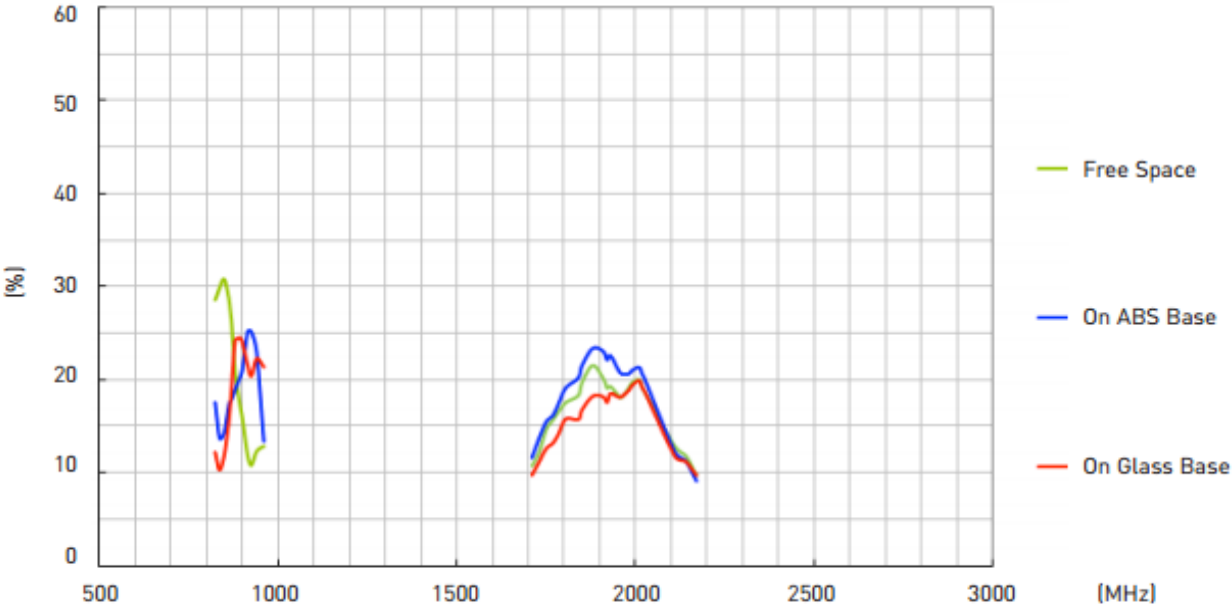

**5.3 Peak Gain**

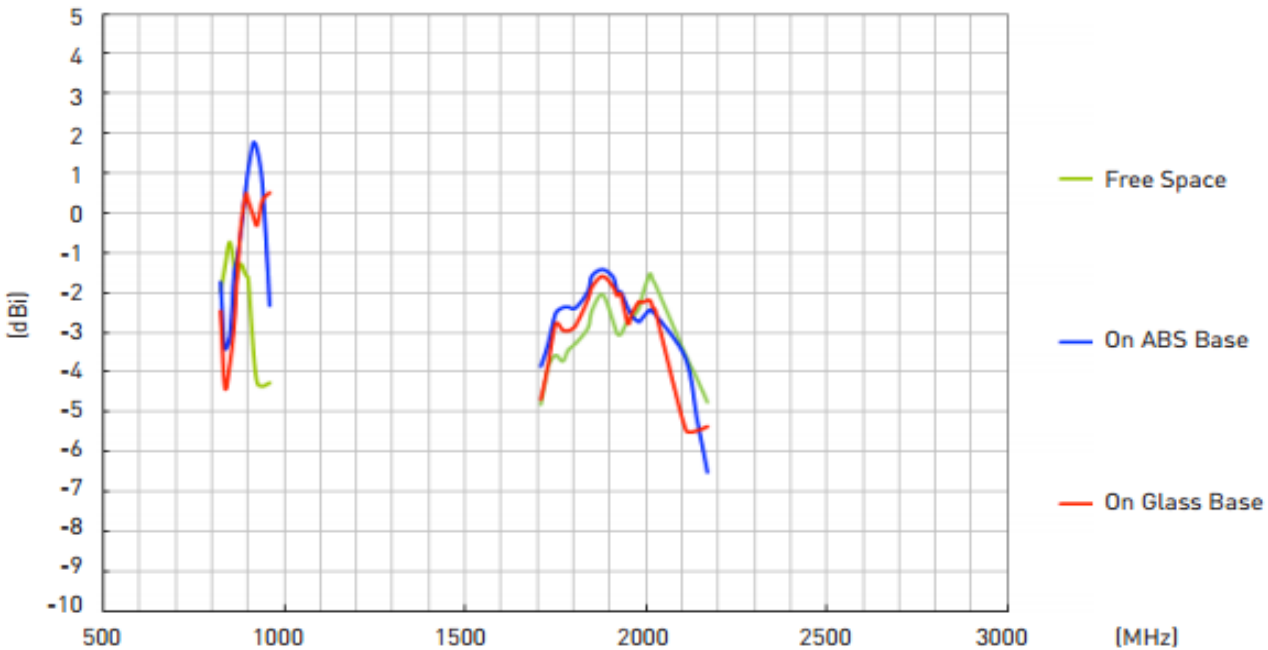

**5.4 Average Gain**

**5.5**

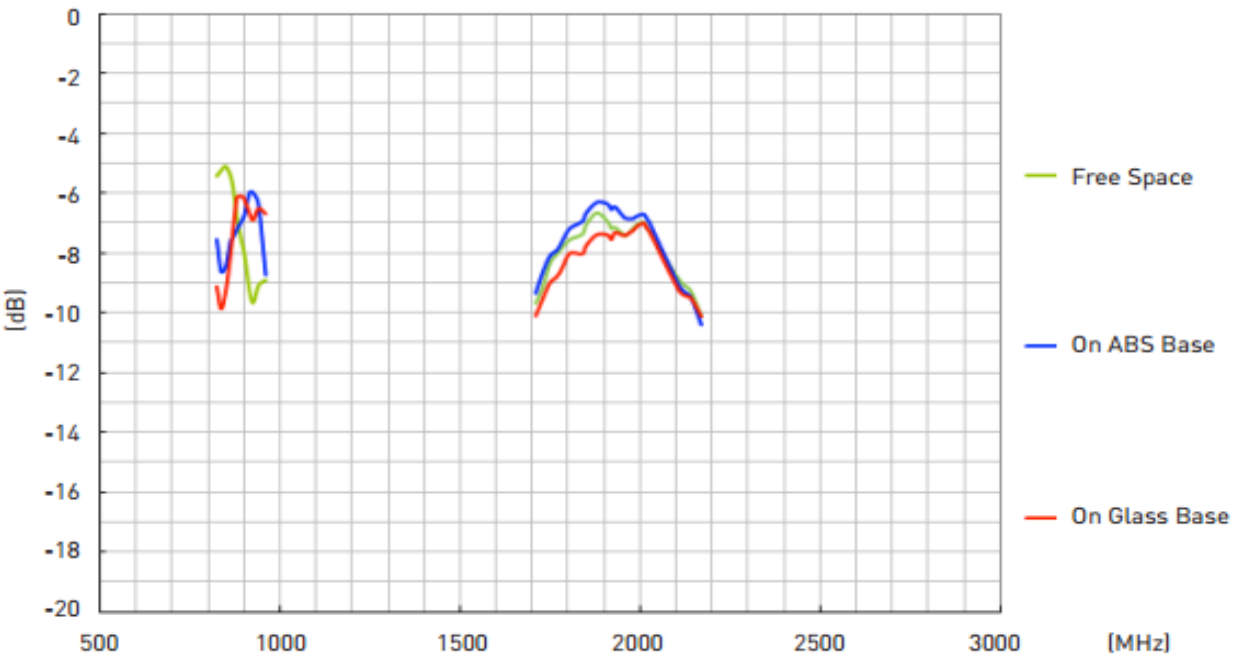

**5.6 Radiation Patterns**

**5.5.1 Free Space**

**XY Plane**

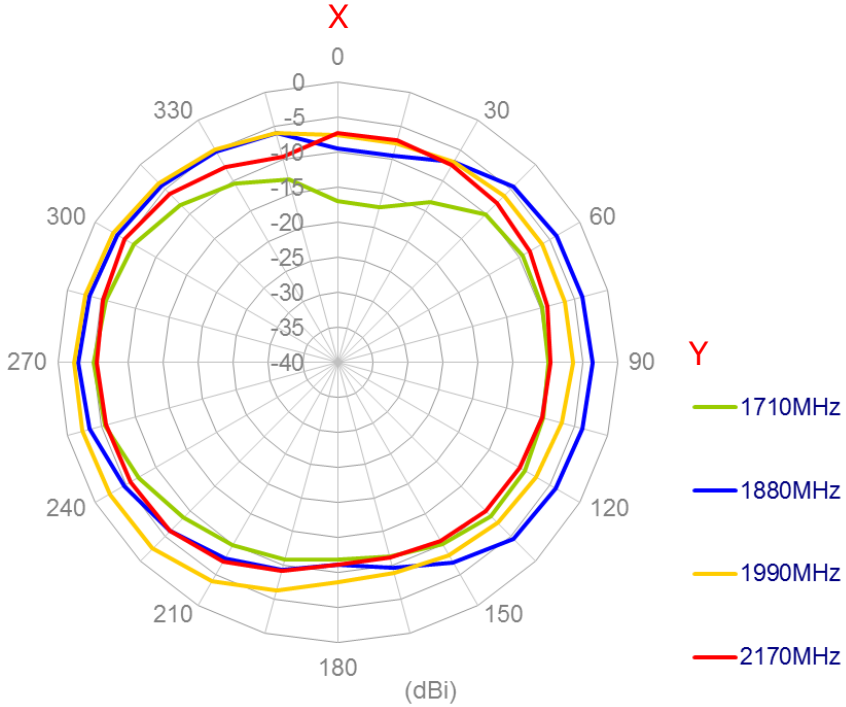
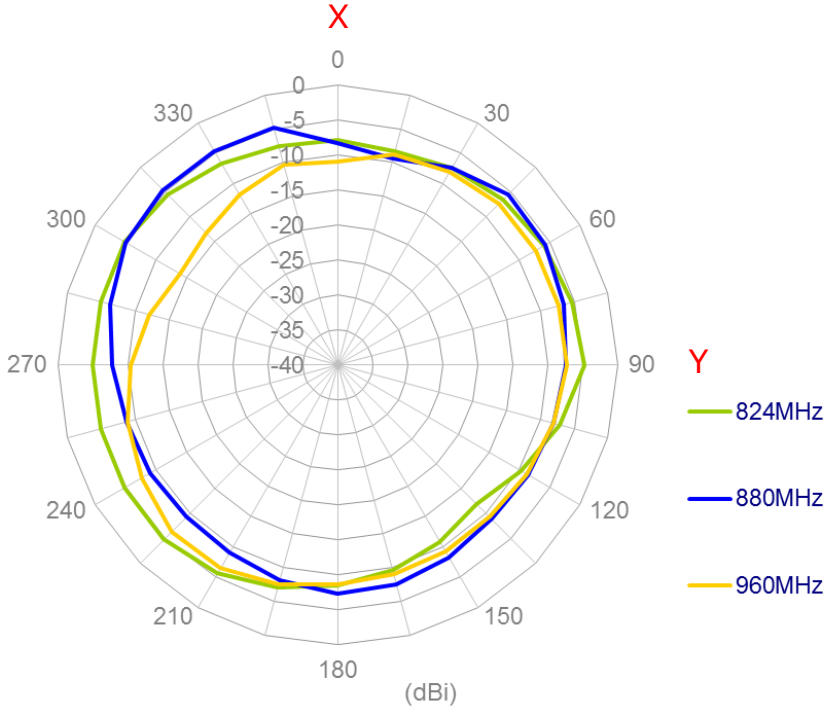

**XZ Plane**

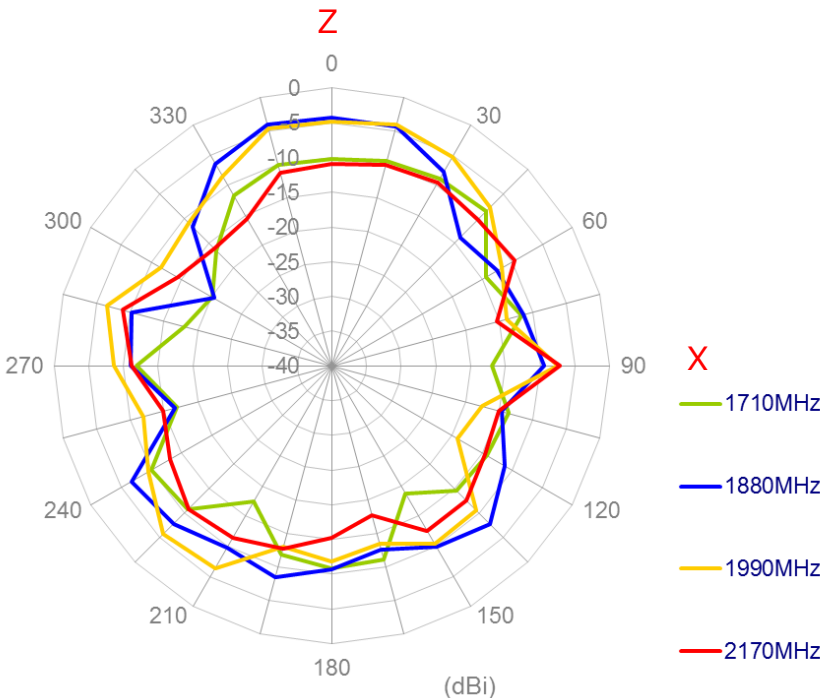
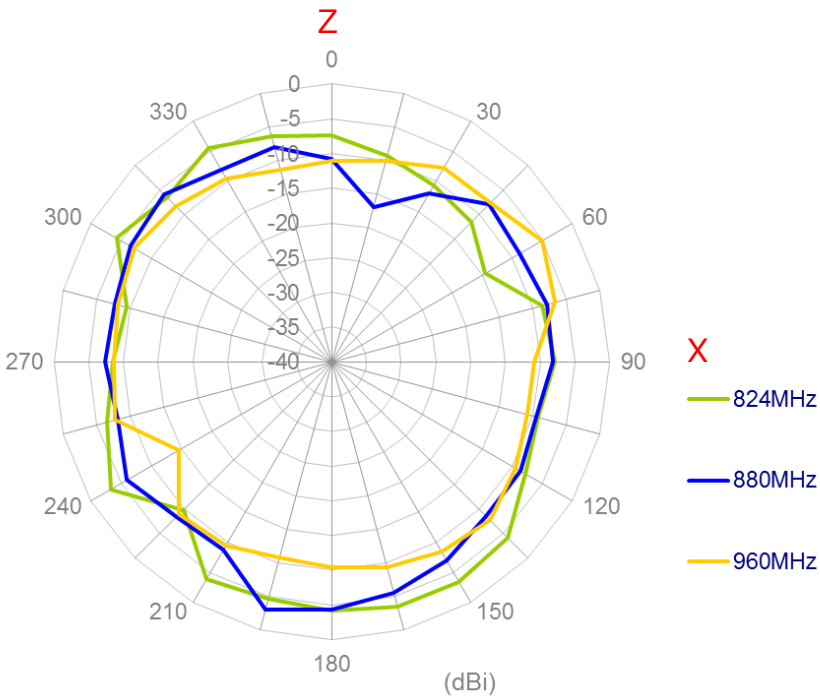



**5.5.2 On ABS Base  
XY Plane**

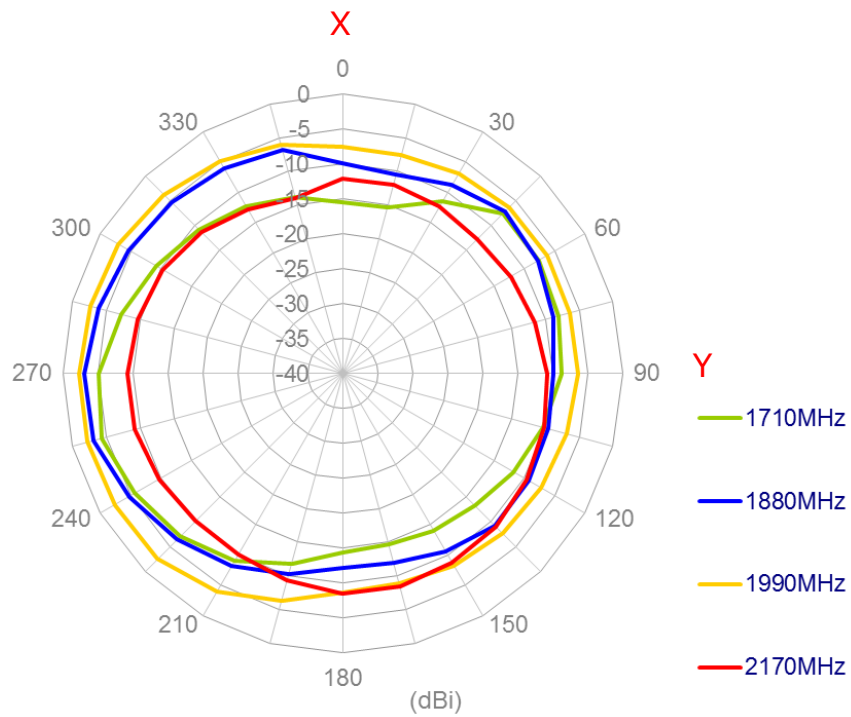
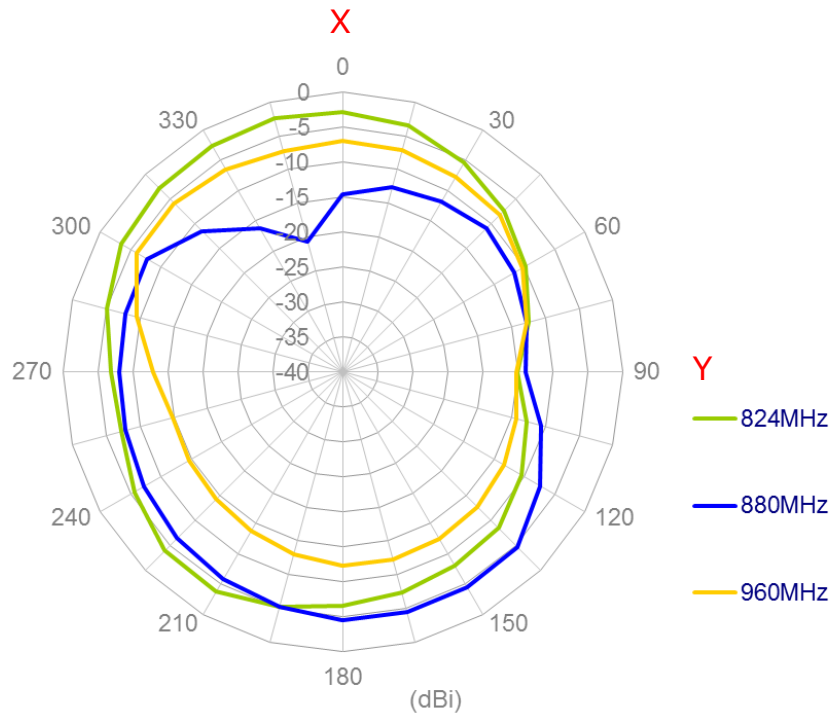

**XZ Plane**

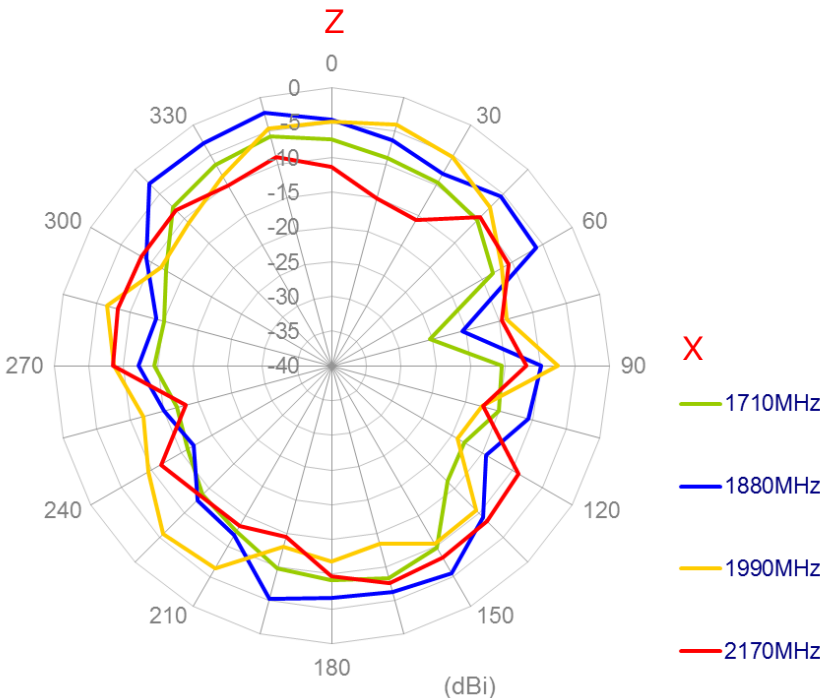
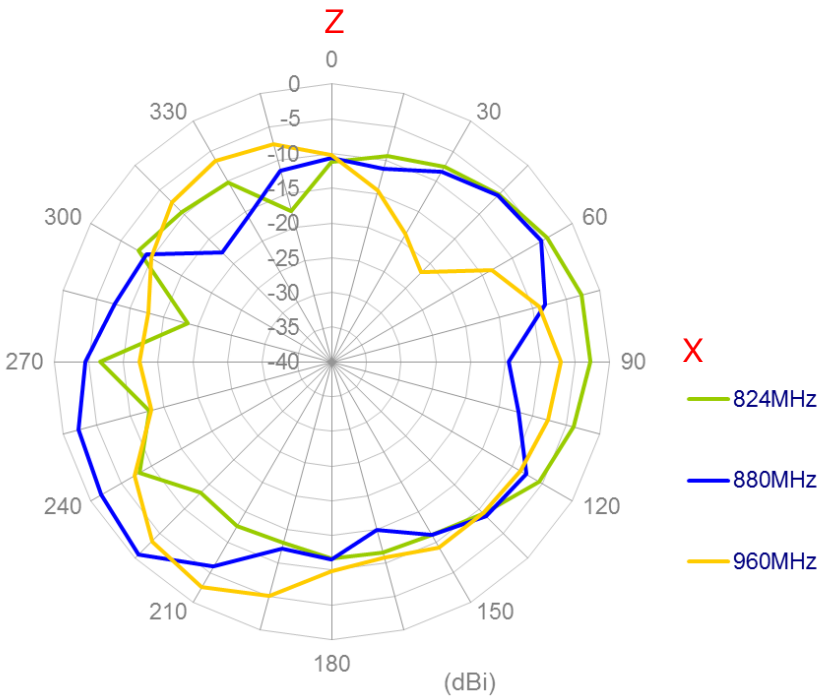

**5.2.3 On Glass Base  
XY Plane**

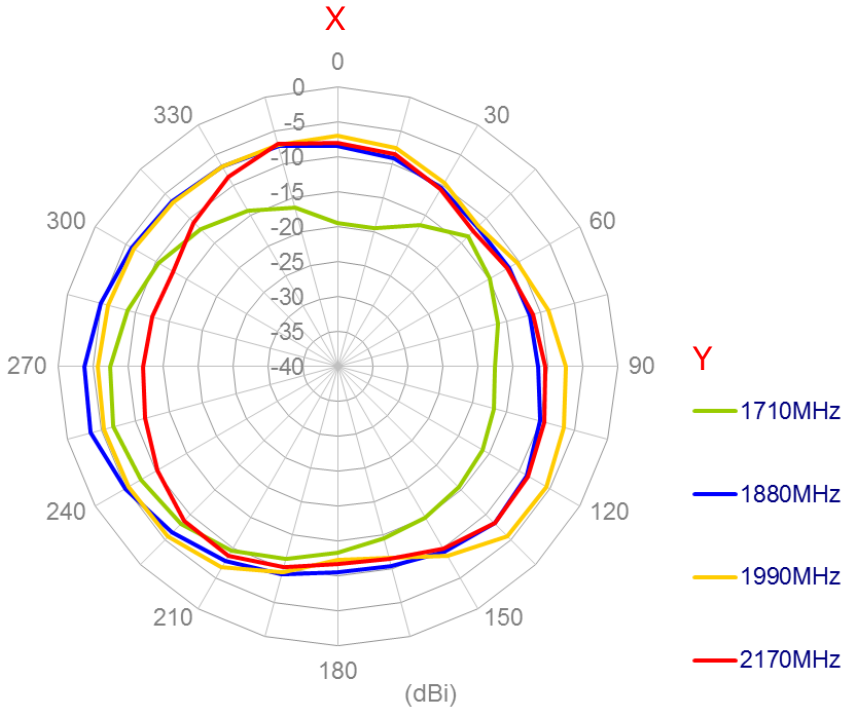
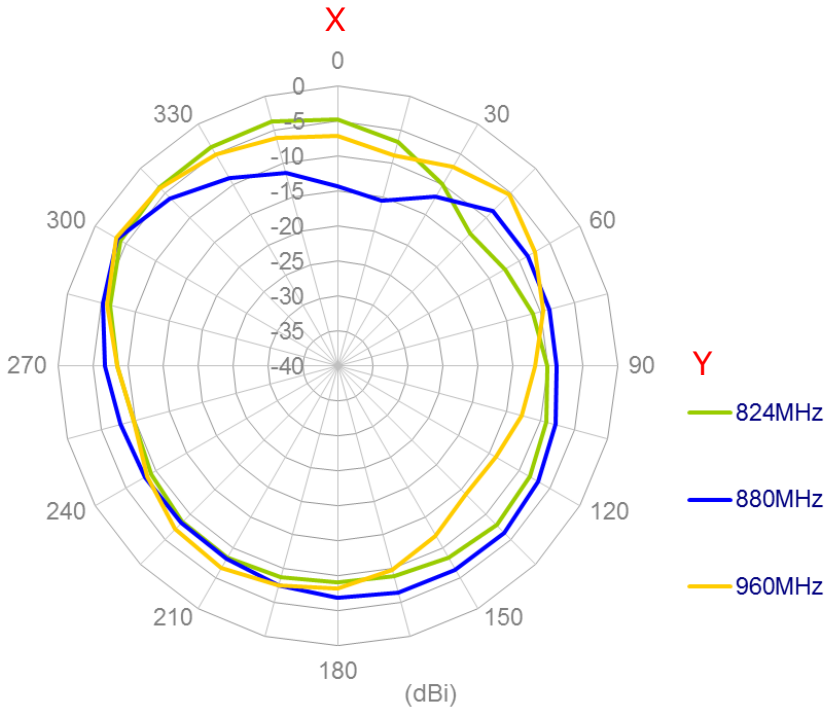

**XZ Plane**

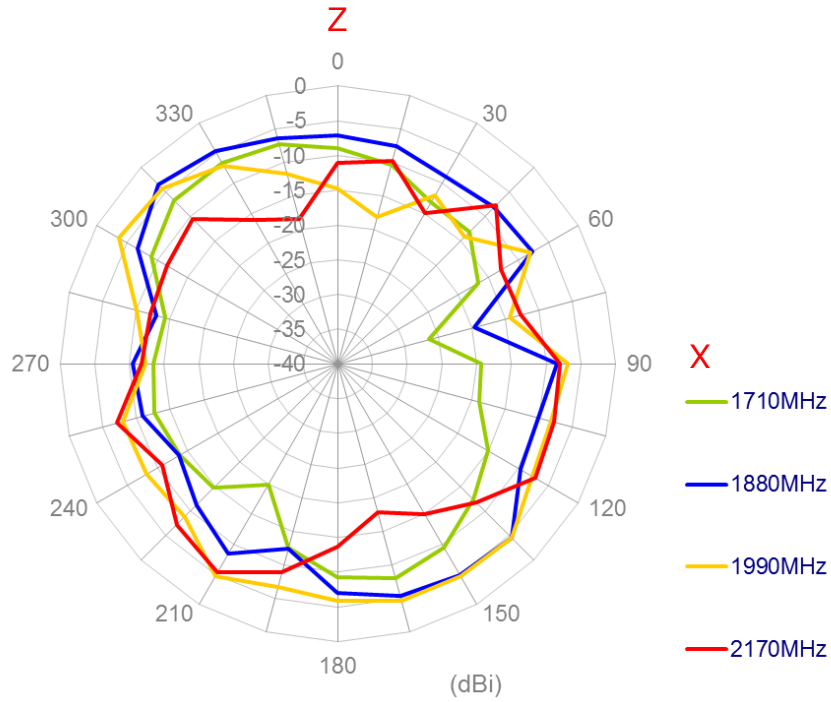
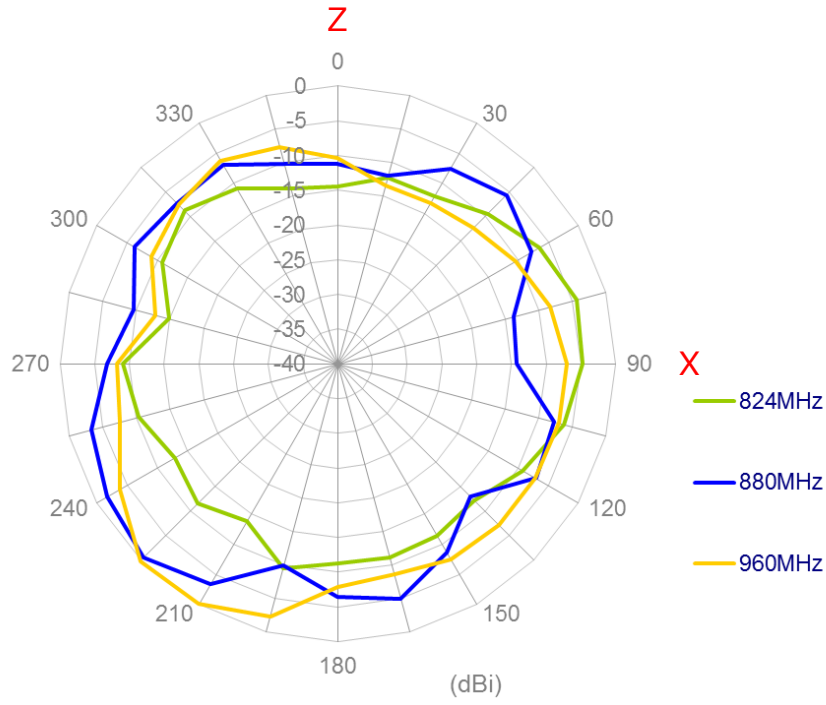

## 6. Drawings

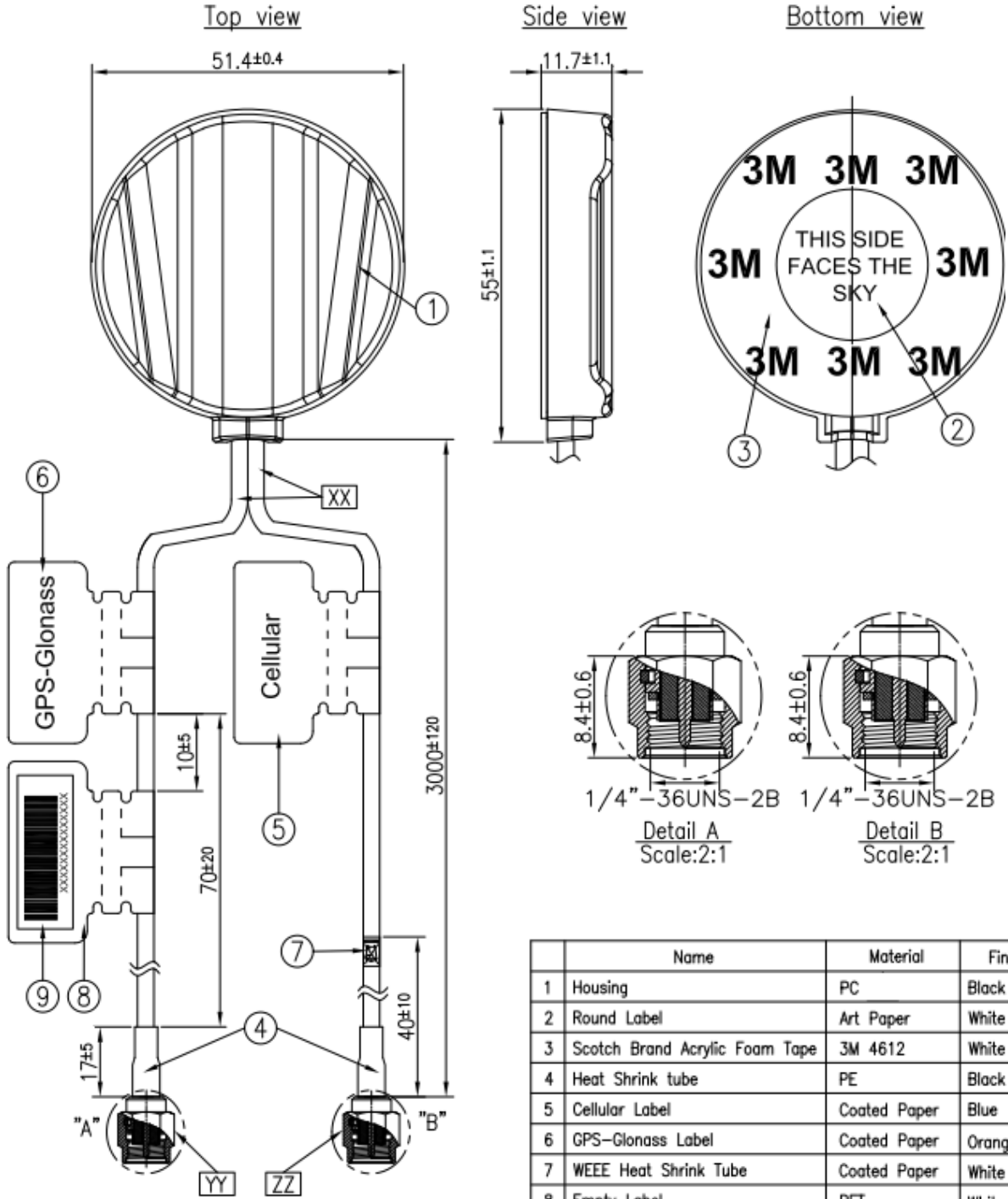

	Name	Material	Finish	QTY
1	Housing	PC	Black	1
2	Round Label	Art Paper	White	1
3	Scotch Brand Acrylic Foam Tape	3M 4612	White Liner	1
4	Heat Shrink tube	PE	Black	2
5	Cellular Label	Coated Paper	Blue	1
6	GPS-Glonass Label	Coated Paper	Orange	1
7	WEEE Heat Shrink Tube	Coated Paper	White	1
8	Empty Label	PET	White	1
9	Barcode Label	PET	White	1

	Name	Material	Finish	QTY
XX	Cable Type	RG174	Black	2
YY	Connector Type	SMA(M)ST	Au Plated	1
ZZ	Connector Type	SMA(M)ST	Ni Plated	1

# 7. Packaging

**MA204.A.LB.002**  
**Packaging Specifications**

1 pcs MA204.A.LB.002 per PE Bag  
 Bag Dimensions - 100 x 210 mm  
 Weight - 121g

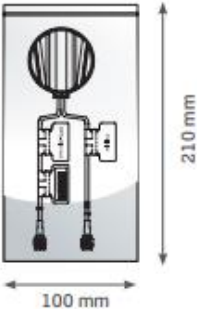

10 pcs MA204.A.LB.002 per PE Large Bag  
 Bag Dimensions - 500 x 350mm  
 Weight - 1.4kg

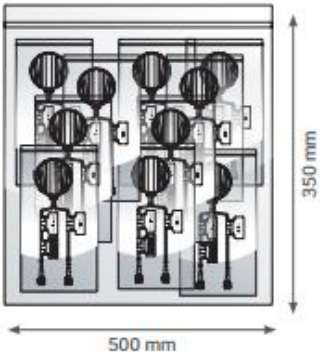

80 pcs MA204.A.LB.002 per carton  
 Carton - 400 x 340 x 220mm  
 Weight - 10.7Kg

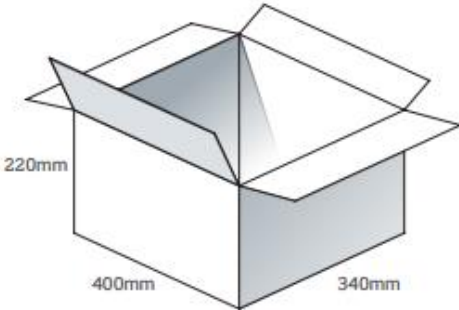

Pallet Dimensions 1200 x 1000 x 1500mm  
 54 Cartons per Pallet  
 9 Cartons per layer  
 6 Layers

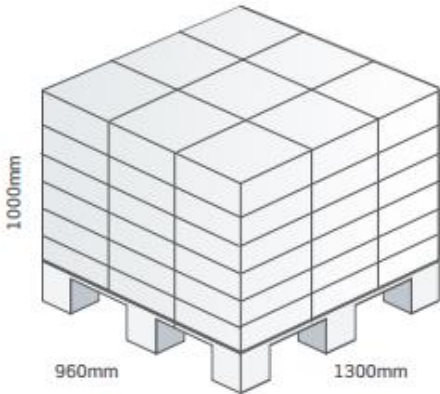

Taoglas makes no warranties based on the accuracy or completeness of the contents of this document and reserves the right to make changes to specifications and product descriptions at any time. Taoglas reserves all rights to this document and the information contained herein.

Reproduction, use or disclosure to third parties without express permission is strictly prohibited.

Copyright © Taoglas