



TAOGLAS®



Datasheet

Monsoon 3-in-1

Part No:
MA172.A.LBC.001

Description:

Monsoon 3-in-1 GNSS, Dual-Band Wi-Fi & LTE
Low Profile Permanent Mount Antenna

Features:

- 1*LTE Antenna
- 1*Dual-Band Wi-Fi Antenna (2.4/5.8 GHz)
- 1*Active GNSS Antenna - GPS L1 and GLONASS L1
- Permanent (Screw) Mount
- Covering Sub 6GHz Bands
- IP67 Rated, Robust PC/ABS Enclosure
- LTE: 3m CFD-200 Cable and SMA(M)ST Connector
- Wi-Fi: 3m CFD-200 Cable and RP-SMA(M)ST Connector
- GNSS: 3m RG-174 Cable and SMA(M)ST Connector
- Dimensions: 204 * 69 * 31 mm
- REACH & RoHS Compliant

1. Introduction	3
2. Specifications	4
3. Antenna Characteristics	10
4. Radiation Patterns	20
5. Mechanical Drawing	29
6. Packaging	30
7. Application Note	31
<hr/>	
Changelog	40

Taoglas makes no warranties based on the accuracy or completeness of the contents of this document and reserves the right to make changes to specifications and product descriptions at any time without notice. Taoglas reserves all rights to this document and the information contained herein. Reproduction, use or disclosure to third parties without express permission is strictly prohibited. Copyright © Taoglas Ltd.



1. Introduction



The Monsoon MA172 is a low profile 3-in-1 combination antenna. It integrates high-performing LTE and Wi-Fi antennas with an active GNSS antenna that supports both the GPS L1 and GLONASS L1 bands. All antennas are enclosed in a fully IP67 rated waterproof housing, designed for use in the most rugged of environments.

Typical applications include:

- HD Video over LTE -First Responder and Emergency Services
- Intelligent Transport Systems
- Internet of Things (IoT market)
- -High Definition Video Broadcast Systems
- Wireless LTE M2M Devices
- Digital Signage

Both the LTE antenna and the Wi-Fi antenna are designed for high efficiency, even without a ground plane. 4G LTE applications demand high speed data uplink and downlink and the high efficiency and gain characteristics exhibited by this antenna help to achieve the required signal to noise ratio and throughput to solve these challenges. Low loss cables are used to keep efficiency high over long cable lengths.

The GNSS antenna has been optimized to work on both GPS and GLONASS bands. Dual GPS/GLONASS systems can accelerate time to first fix, especially in challenging environments such as urban canyons or any environment where a large portion of the sky is blocked. A front-end SAW filter protects the GNSS antenna's LNA from potentially damaging out-of-band wireless transmissions, ensuring that it can be used in environments where these signals might be encountered.

Cable and connectors are customizable, contact your regional Taoglas sales office for customization and additional support.

2. Specifications

GNSS Electrical			
Frequency	GPS L1: 1575.42 MHz \pm 1.023 MHz GLONASS L1: 1602 MHz \pm 1.023 MHz		
Bandwidth - Return Loss <-10 dB	6 MHz min		
Return loss (GPS L1 GLONASS L1)	< -10 dB		
Passive Gain at Zenith (GPS L1 and GLONASS L1)	+1.0 dBic typ.		
Polarization	RHCP		
Impedance	50 Ω		
LNA Out-band Attenuation	fo = 1575.42MHz fo \pm 30 MHz 5dB Min. fo \pm 50 MHz 20dB Min. fo \pm 100 MHz 25dB Min.		
Input Voltage	Min:1.8V	Typ. 3.0V	Max: 5.5V
Total Gain @ Zenith	25dBic	30dBic	32dBic
Current Consumption	6mA	12mA	30mA
Noise Figure	2.7dB	3.0dB	3.7dB

LTE Antenna								
Frequency (MHz)		LTE700	GSM850	GSM900	DCS	PCS	UMTS1	LTE2600
		698~824	824~894	880~960	1710~1880	1850~1990	1920~2170	2490~2690
Efficiency (%)								
Free Space	0.3m	45.80	49.28	49.79	64.97	52.04	42.23	49.92
	1m	43.38	47.06	47.53	60.63	47.46	38.52	46.04
	2m	40.48	43.10	43.35	54.03	42.30	34.07	40.37
	3m	37.53	40.06	40.34	48.63	37.62	29.99	35.65
On 30x30cm Ground Plane	0.3m	42.42	56.25	54.11	66.98	46.32	38.51	45.74
	1m	40.26	53.72	51.69	62.52	42.24	35.13	42.19
	2m	37.57	49.22	47.14	55.72	37.65	31.05	36.96
	3m	34.71	45.72	43.84	50.17	33.49	27.34	32.68
Average Gain (dB)								
Free Space	0.3m	-3.39	-3.07	-3.03	-2.84	-3.74	-3.02	-1.70
	1m	-3.63	-3.27	-3.23	-3.24	-4.14	-3.37	-2.10
	2m	-3.93	-3.65	-3.63	-3.74	-4.68	-3.94	-2.71
	3m	-4.26	-3.97	-3.94	-4.25	-5.23	-4.48	-3.31
On 30x30cm Ground Plane	0.3m	-3.72	-2.50	-2.67	-1.74	-3.34	-4.14	-3.40
	1m	-3.95	-2.70	-2.87	-2.04	-3.74	-4.54	-3.75
	2m	-4.25	-3.08	-3.27	-2.54	-4.24	-5.08	-4.32
	3m	-4.60	-3.40	-3.58	-3.00	-4.75	-5.63	-4.86
Peak Gain (dBi)								
Free Space	0.3m	-2.47	-2.69	-2.69	-1.70	-2.41	-3.23	-2.21
	1m	-2.77	-2.89	-2.89	-2.00	-2.81	-3.63	-2.61
	2m	-3.07	-3.29	-3.29	-2.50	-3.31	-4.13	-3.11
	3m	-3.37	-3.59	-3.59	-2.99	-3.81	-4.63	-3.71
On 30x30cm Ground Plane	0.3m	-2.57	-2.03	-2.54	-1.39	-2.92	-3.47	-2.46
	1m	-2.77	-2.23	-2.74	-1.69	-3.32	-3.87	-2.76
	2m	-3.07	-2.63	-3.14	-2.19	-3.82	-4.47	-3.36
	3m	-3.47	-2.93	-3.44	-2.59	-4.32	-4.97	-3.86
Impedance	50 Ω							
Return loss	< -3 dB							
Polarization	Vertical							

Wi-Fi Antenna (2.4GHz/5.8GHz)			
Frequency (MHz)		2400~2500	4900~5850
Efficiency (%)			
Free Space	0.3m	65.35	49.83
	1m	59.60	42.96
	2m	51.91	34.82
	3m	45.21	28.22
On 30x30cm Ground Plane	0.3m	64.51	51.58
	1m	58.84	44.46
	2m	51.25	36.05
	3m	44.64	29.21
Average Gain (dB)			
Free Space	0.3m	-1.85	-3.03
	1m	-2.25	-3.67
	2m	-2.85	-4.58
	3m	-3.45	-5.49
On 30x30cm Ground Plane	0.3m	-1.90	-2.88
	1m	-2.30	-3.52
	2m	-2.90	-4.43
	3m	-3.50	-5.34
Peak Gain (dBi)			
Free Space	0.3m	-0.99	-1.95
	1m	-1.39	-2.55
	2m	-1.99	-3.45
	3m	-2.59	-4.35
On 30x30cm Ground Plane	0.3m	-1.15	-1.81
	1m	-1.55	-2.41
	2m	-2.15	-3.31
	3m	-2.75	-4.21
Impedance	50 Ω		
Return loss	< -6 dB		
Polarization	Vertical		

Mechanical	
Dimensions	203.95 x 68.96 x 30.95 mm
Cable	LTE: 3000mm CFD-200 Wi-Fi: 3000mm CFD-200 GNSS: 3000mm RG-174
Connector	LTE: SMA(M) Wi-Fi: RP-SMA(M) GNSS: SMA(M)
Casing	PC+ABS
Adhesive	3M 9448HK + CR4305
Sealant	Rubber Stopper
Weight	550 g
Environmental	
Protection	IP67
Corrosion	5% NaCl for 96hrs - Nickel plated steel base and thread
Temperature Range	-40°C to +85°C
Thermal Shock	100 cycles -40°C to +85°C
Humidity	Non-condensing 65°C 95% RH
Shock (Drop Test)	1m drop on concrete 6 axes
Recommended Mounting Torque	24.5N·m
Maximum Mounting Torque	29.5N·m

LTE Bands on 30X30 Groundplane				
Band Number	LTE / LTE-Advanced / WCDMA / HSPA / HSPA+ / TD-SCDMA			
	Uplink	Downlink	Covered	Covered
1	UL: 1920 to 1980	DL: 2110 to 2170	✓	✓
2	UL: 1850 to 1910	DL: 1930 to 1990	✓	✓
3	UL: 1710 to 1785	DL: 1805 to 1880	✓	✓
4	UL: 1710 to 1755	DL: 2110 to 2155	✓	✓
5	UL: 824 to 849	DL: 869 to 894	✓	✓
7	UL: 2500 to 2570	DL: 2620 to 2690	✓	✓
8	UL: 880 to 915	DL: 925 to 960	✓	✓
9	UL: 1749.9 to 1784.9	DL: 1844.9 to 1879.9	✓	✓
11	UL: 1427.9 to 1447.9	DL: 1475.9 to 1495.9	✓	✓
12	UL: 699 to 716	DL: 729 to 746	✓	✓
13	UL: 777 to 787	DL: 746 to 756	✓	✓
14	UL: 788 to 798	DL: 758 to 768	✓	✓
17	UL: 704 to 716	DL: 734 to 746 (LTE only)	✓	✓
18	UL: 815 to 830	DL: 860 to 875 (LTE only)	✓	✓
19	UL: 830 to 845	DL: 875 to 890	✓	✓
20	UL: 832 to 862	DL: 791 to 821	✓	✓
21	UL: 1447.9 to 1462.9	DL: 1495.9 to 1510.9	✓	✓
22	UL: 3410 to 3490	DL: 3510 to 3590	✓	✓
23	UL: 2000 to 2020	DL: 2180 to 2200 (LTE only)	✓	✓
24	UL: 1625.5 to 1660.5	DL: 1525 to 1559 (LTE only)	✓	✓
25	UL: 1850 to 1915	DL: 1930 to 1995	✓	✓
26	UL: 814 to 849	DL: 859 to 894	✓	✓
27	UL: 807 to 824	DL: 852 to 869 (LTE only)	✓	✓
28	UL: 703 to 748	DL: 758 to 803 (LTE only)	✓	✓
29	UL: -	DL: 717 to 728 (LTE only)	✓	✓
30	UL: 2305 to 2315	DL: 2350 to 2360 (LTE only)	✓	✓
31	UL: 452.5 to 457.5	DL: 462.5 to 467.5 (LTE only)	✓	✓
32	UL: -	DL: 1452 - 1496	✓	✓
35		1850 to 1910	✓	✓
38		2570 to 2620	✓	✓
39		1880 to 1920	✓	✓
40		2300 to 2400	✓	✓
41		2496 to 2690	✓	✓
42		3400 to 3600	✓	✓
43		3600 to 3800	✓	✓
71		617 to 698	✓	✓

LTE Bands in Free Space				
Band Number	LTE / LTE-Advanced / WCDMA / HSPA / HSPA+ / TD-SCDMA			
	Uplink	Downlink	Covered	Covered
1	UL: 1920 to 1980	DL: 2110 to 2170	✓	✓
2	UL: 1850 to 1910	DL: 1930 to 1990	✓	✓
3	UL: 1710 to 1785	DL: 1805 to 1880	✓	✓
4	UL: 1710 to 1755	DL: 2110 to 2155	✓	✓
5	UL: 824 to 849	DL: 869 to 894	✓	✓
7	UL: 2500 to 2570	DL: 2620 to 2690	✓	✓
8	UL: 880 to 915	DL: 925 to 960	✓	✓
9	UL: 1749.9 to 1784.9	DL: 1844.9 to 1879.9	✓	✓
11	UL: 1427.9 to 1447.9	DL: 1475.9 to 1495.9	✓	✓
12	UL: 699 to 716	DL: 729 to 746	✓	✓
13	UL: 777 to 787	DL: 746 to 756	✓	✓
14	UL: 788 to 798	DL: 758 to 768	✓	✓
17	UL: 704 to 716	DL: 734 to 746 (LTE only)	✓	✓
18	UL: 815 to 830	DL: 860 to 875 (LTE only)	✓	✓
19	UL: 830 to 845	DL: 875 to 890	✓	✓
20	UL: 832 to 862	DL: 791 to 821	✓	✓
21	UL: 1447.9 to 1462.9	DL: 1495.9 to 1510.9	✓	✓
22	UL: 3410 to 3490	DL: 3510 to 3590	✓	✓
23	UL: 2000 to 2020	DL: 2180 to 2200 (LTE only)	✓	✓
24	UL: 1625.5 to 1660.5	DL: 1525 to 1559 (LTE only)	✓	✓
25	UL: 1850 to 1915	DL: 1930 to 1995	✓	✓
26	UL: 814 to 849	DL: 859 to 894	✓	✓
27	UL: 807 to 824	DL: 852 to 869 (LTE only)	✓	✓
28	UL: 703 to 748	DL: 758 to 803 (LTE only)	✓	✓
29	UL: -	DL: 717 to 728 (LTE only)	✓	✓
30	UL: 2305 to 2315	DL: 2350 to 2360 (LTE only)	✓	✓
31	UL: 452.5 to 457.5	DL: 462.5 to 467.5 (LTE only)	✓	✓
32	UL: -	DL: 1452 - 1496	✓	✓
35		1850 to 1910	✓	✓
38		2570 to 2620	✓	✓
39		1880 to 1920	✓	✓
40		2300 to 2400	✓	✓
41		2496 to 2690	✓	✓
42		3400 to 3600	✓	✓
43		3600 to 3800	✓	✓
71		617 to 698	✓	✓

3. Antenna Characteristics

3.1 LTE and Wi-Fi Antennas

3.1.1 LTE and Wi-Fi Antennas

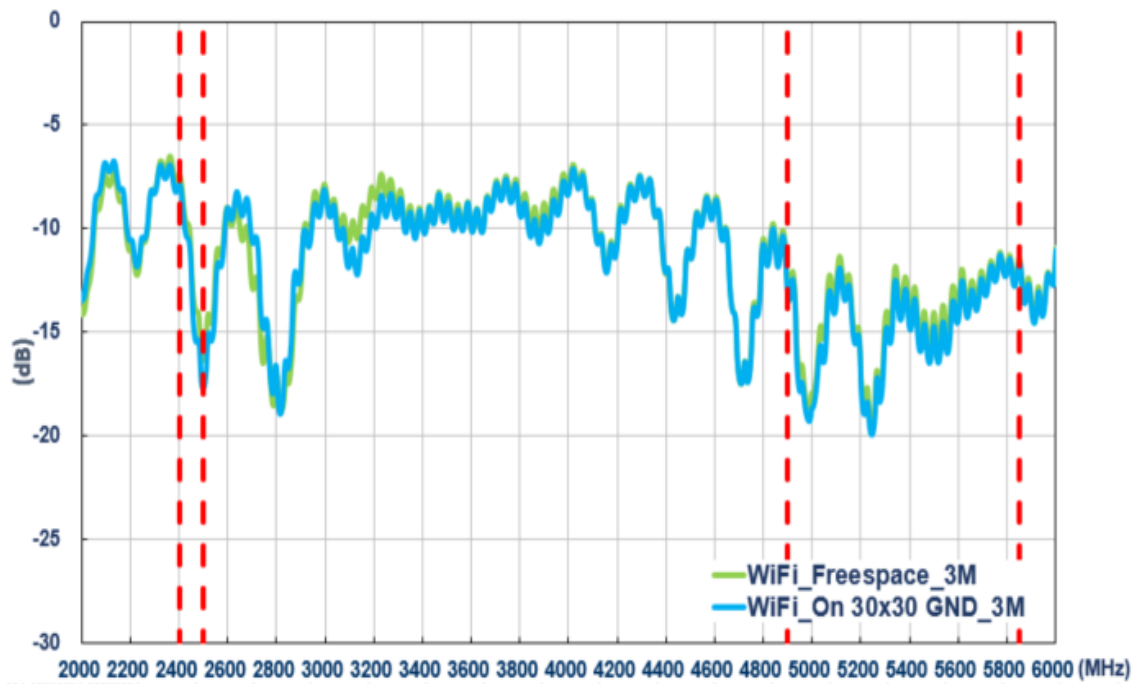
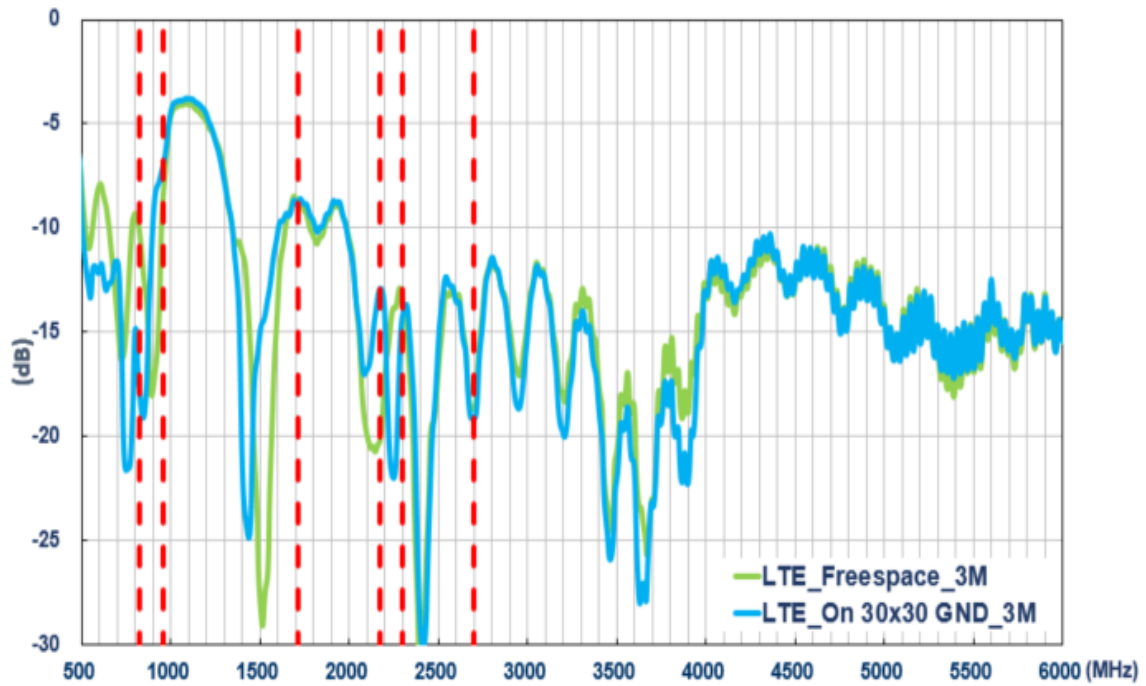

3.1.2. Efficiency – LTE and Wi-Fi

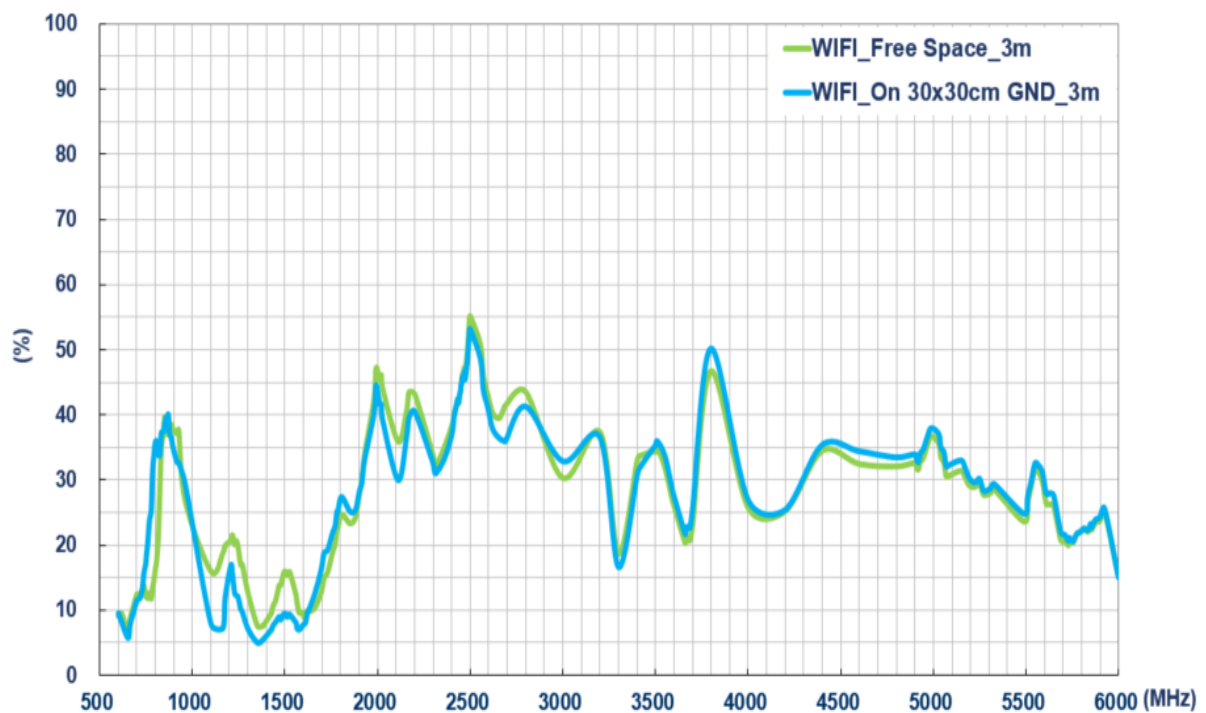
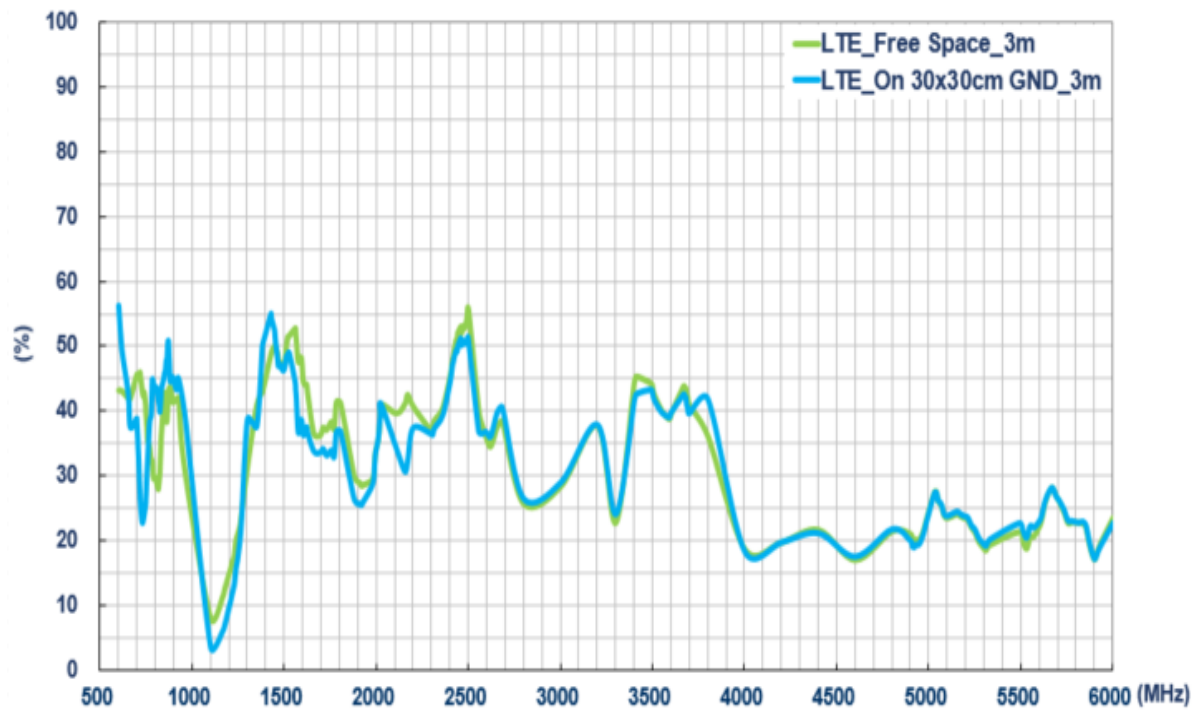

3.1.3. Average Gain – LTE and Wi-Fi

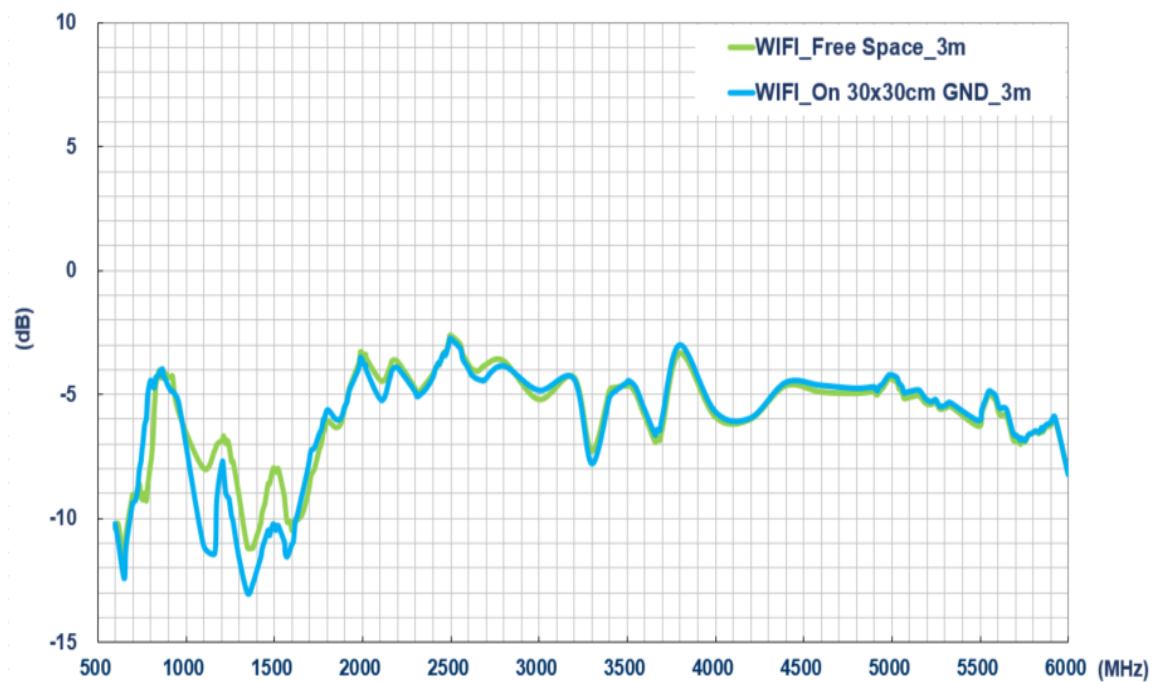
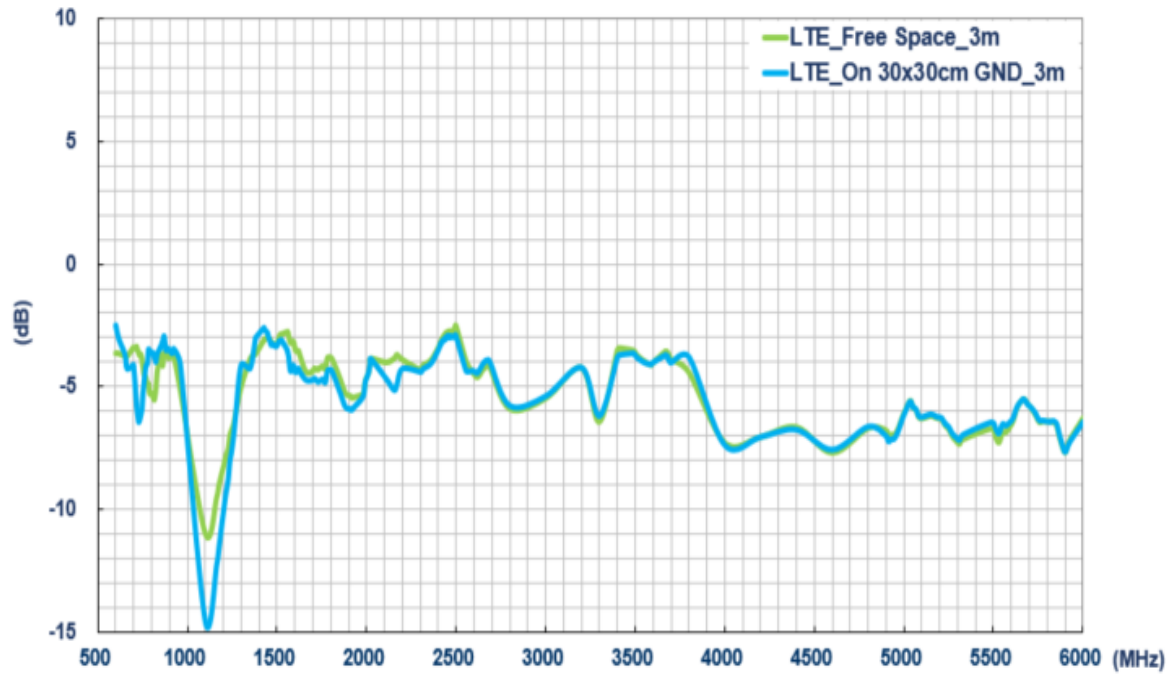

3.1.4. Peak Gain – LTE and Wi-Fi

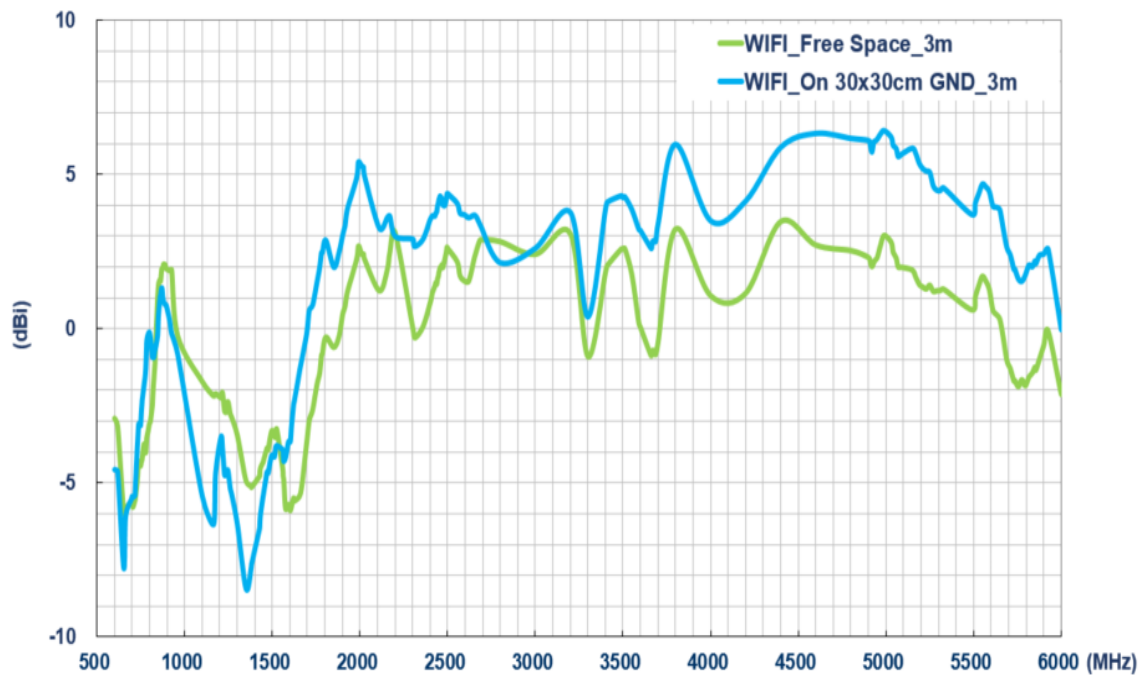
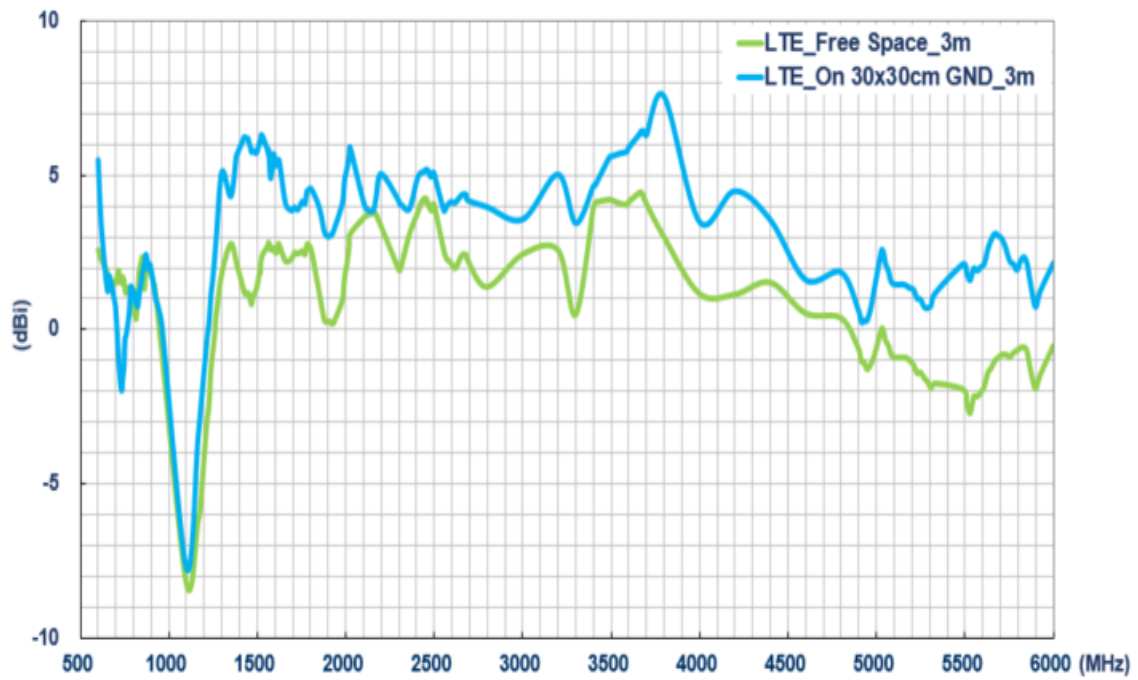

3.1.5. Isolation – LTE and Wi-Fi

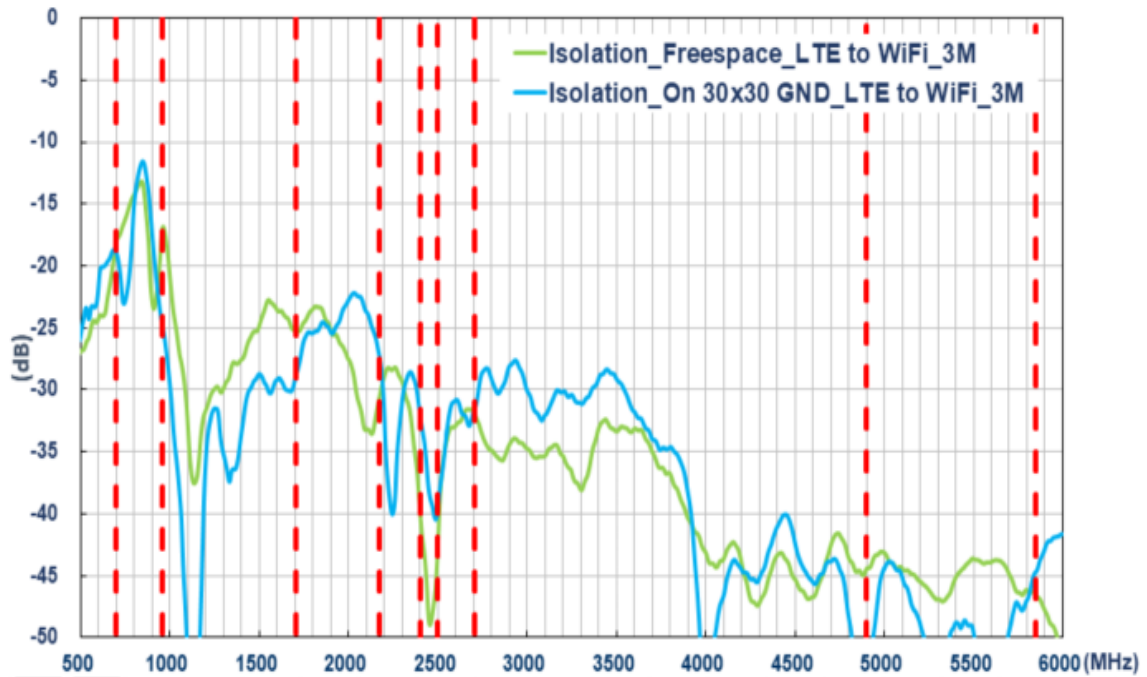

3.1.6. ECC – LTE and Wi-Fi

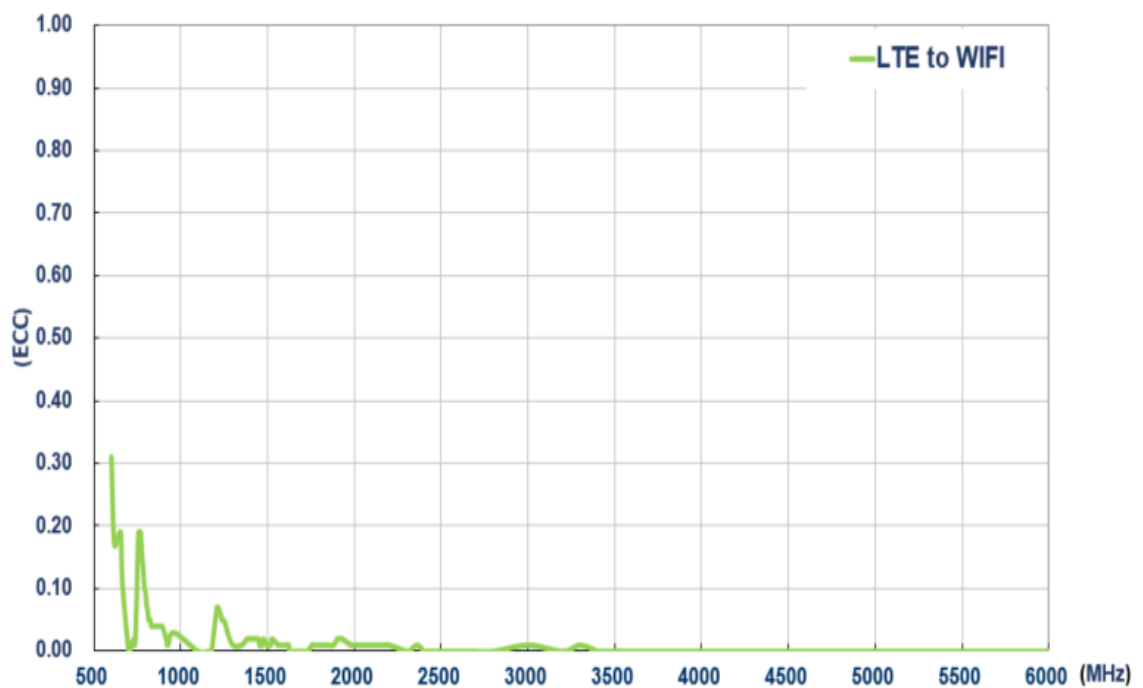

3.2 GNSS Antenna

3.2.1. Block Diagram (Active antenna)

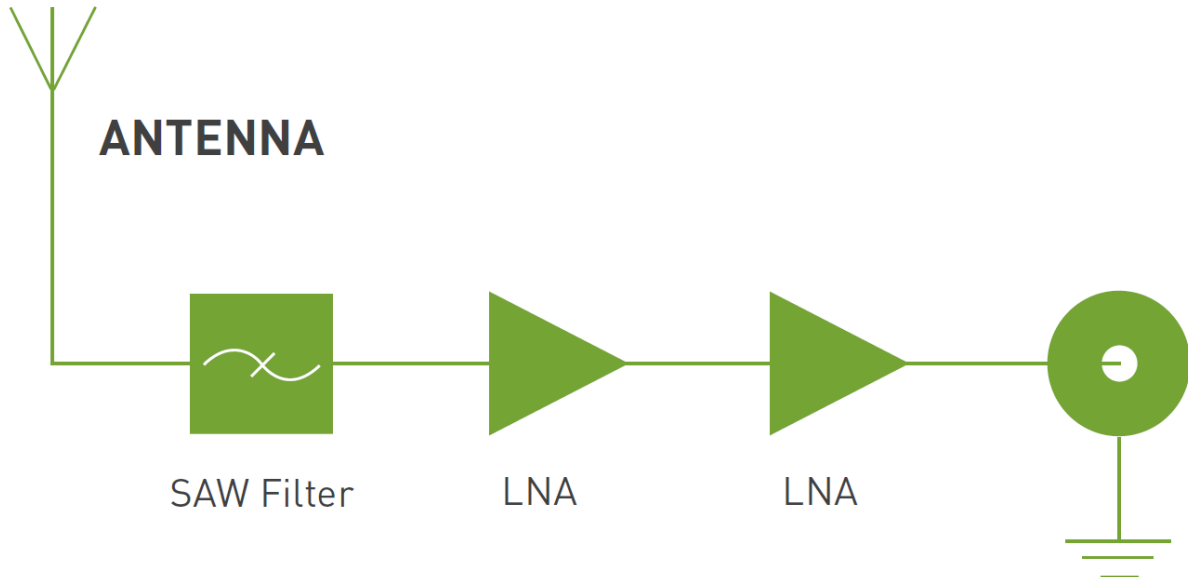

3.2.2. Return Loss – GNSS Antenna

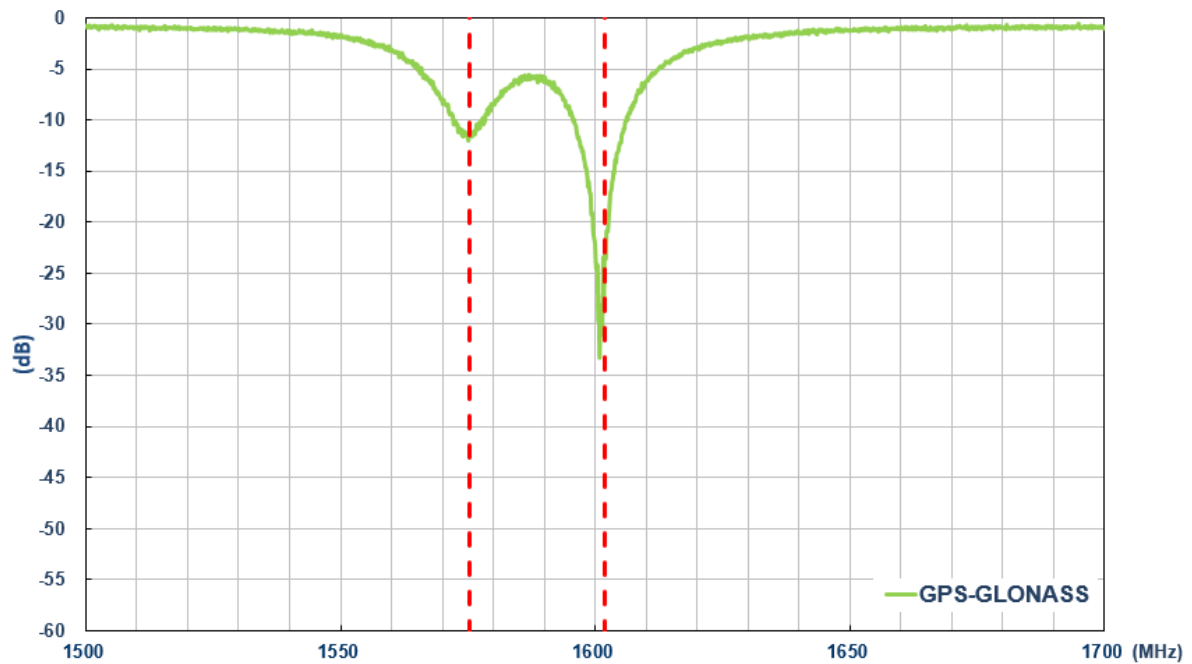

3.2.3. Efficiency – GNSS Antenna (passive measurement)

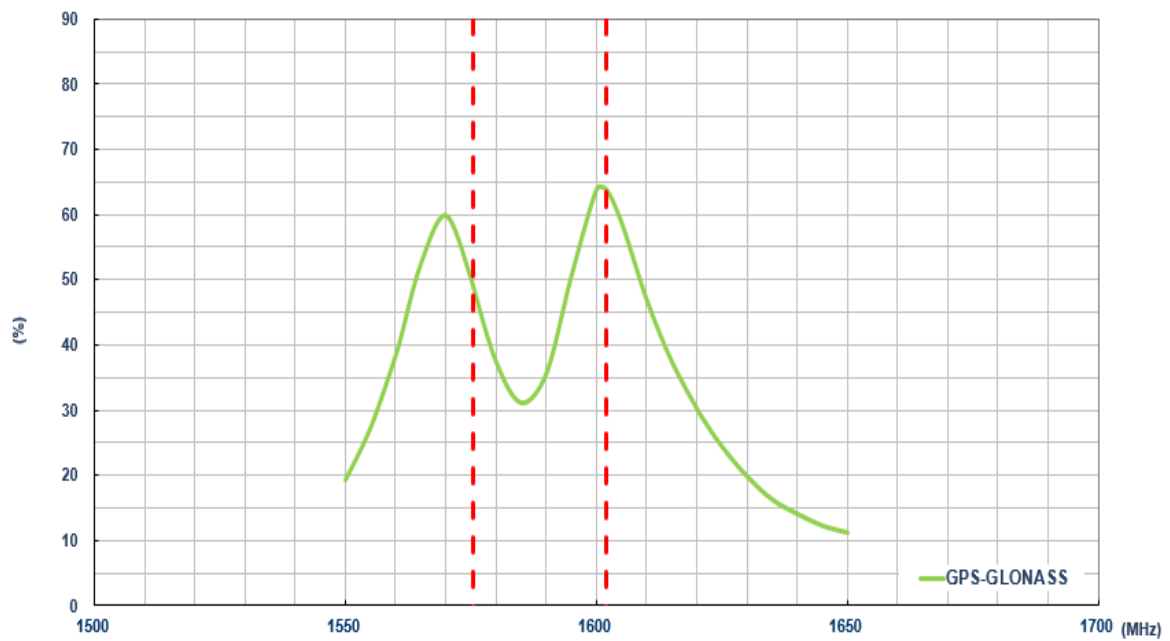

3.2.4. Average Gain – GNSS Antenna (passive measurement)

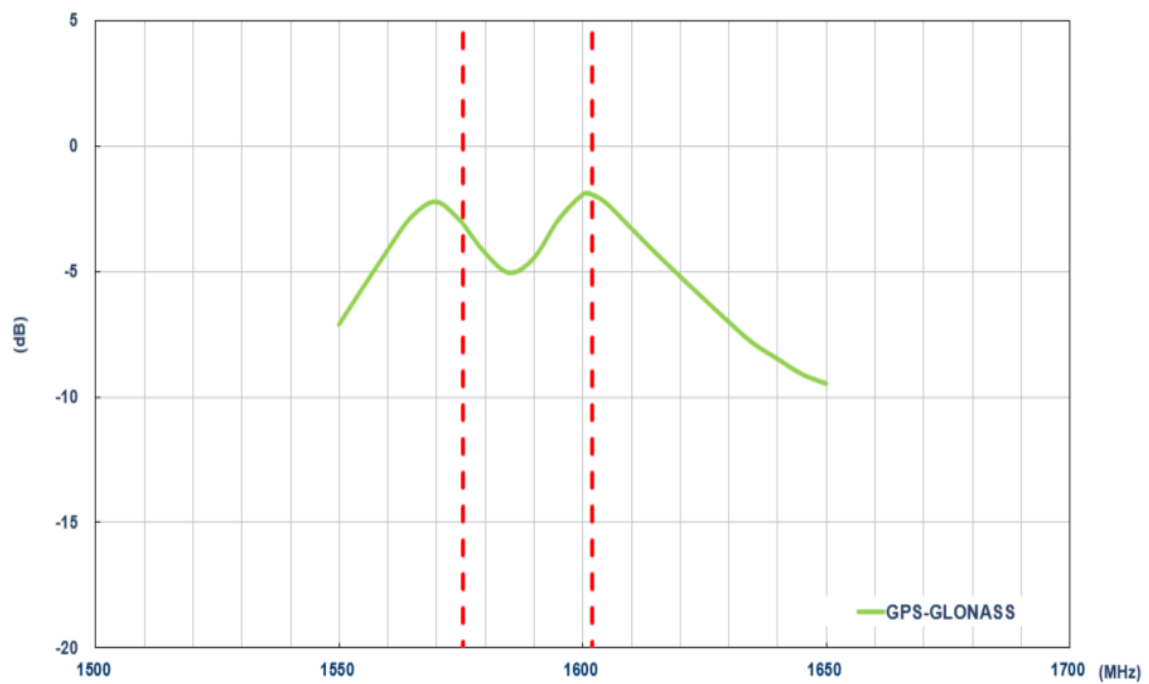

3.2.5. Peak Gain – GNSS Antenna (passive measurement)

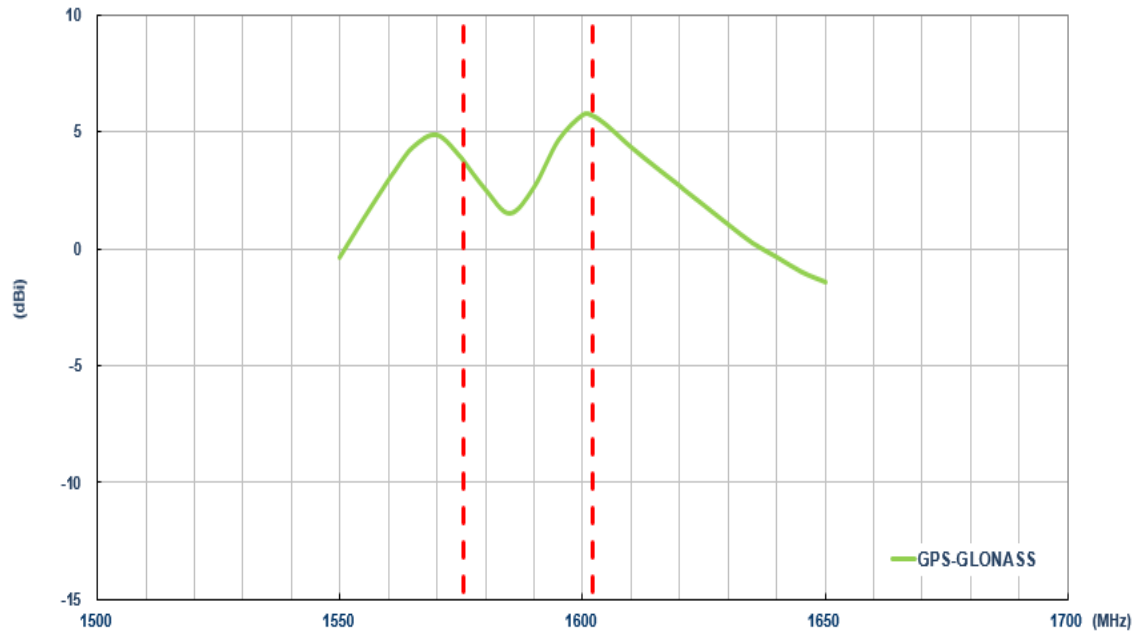

3.2.6. Axial Ratio – GNSS Antenna (Zenith is at 0°)

Axial Ratio at GPS L1 (1575.42 MHz)

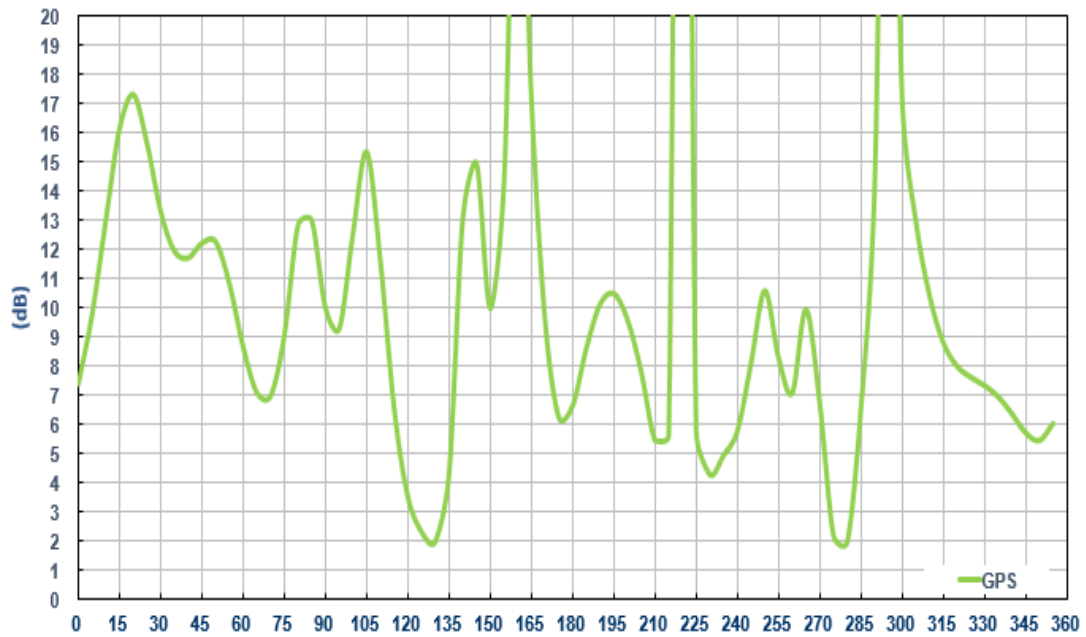

Axial Ratio at GLONASS L1 (1602 MHz)

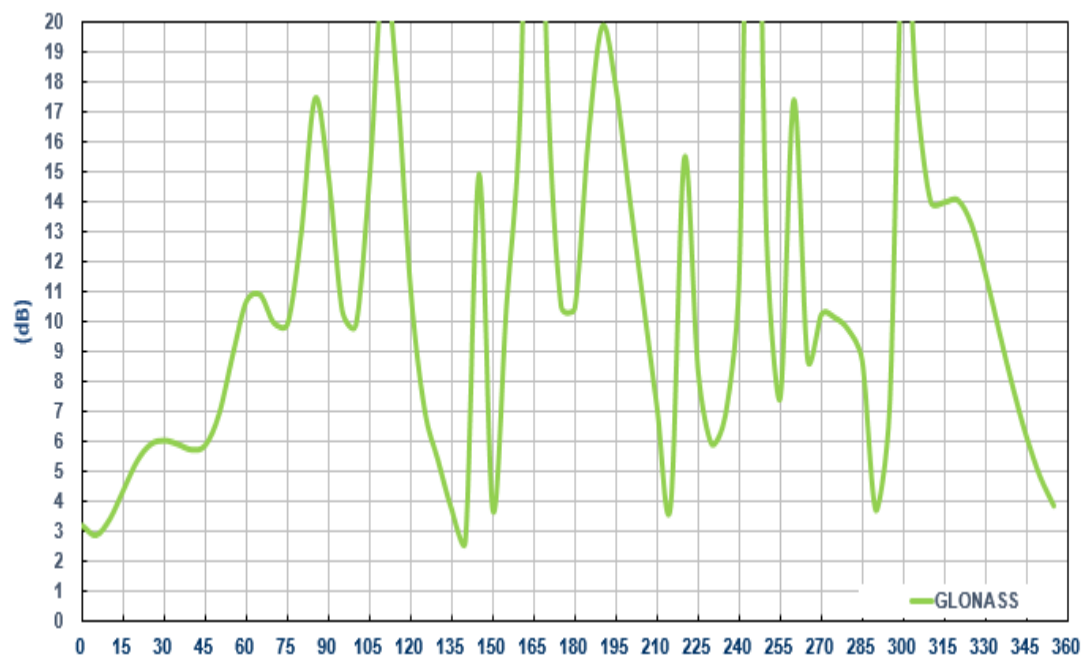

3.2.7. GNSS Antenna Active Measurements

LNA Gain @ 3.0V

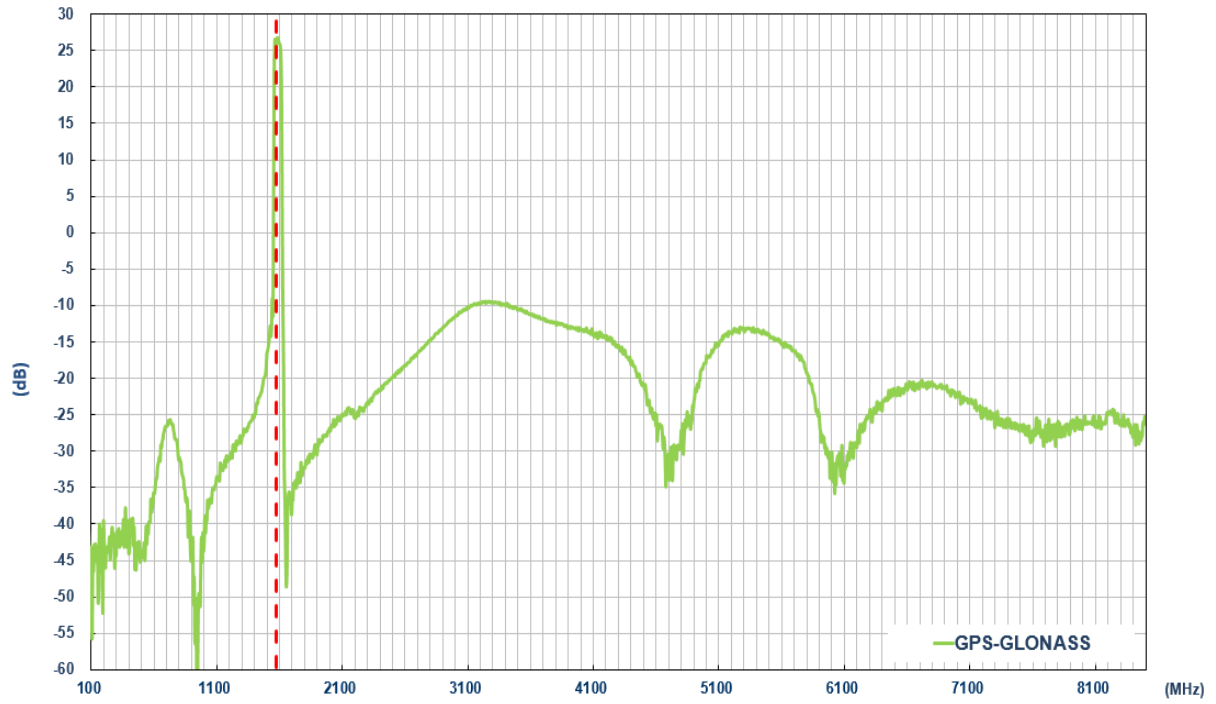

LNA Gain and Noise Figure @ 3.0V

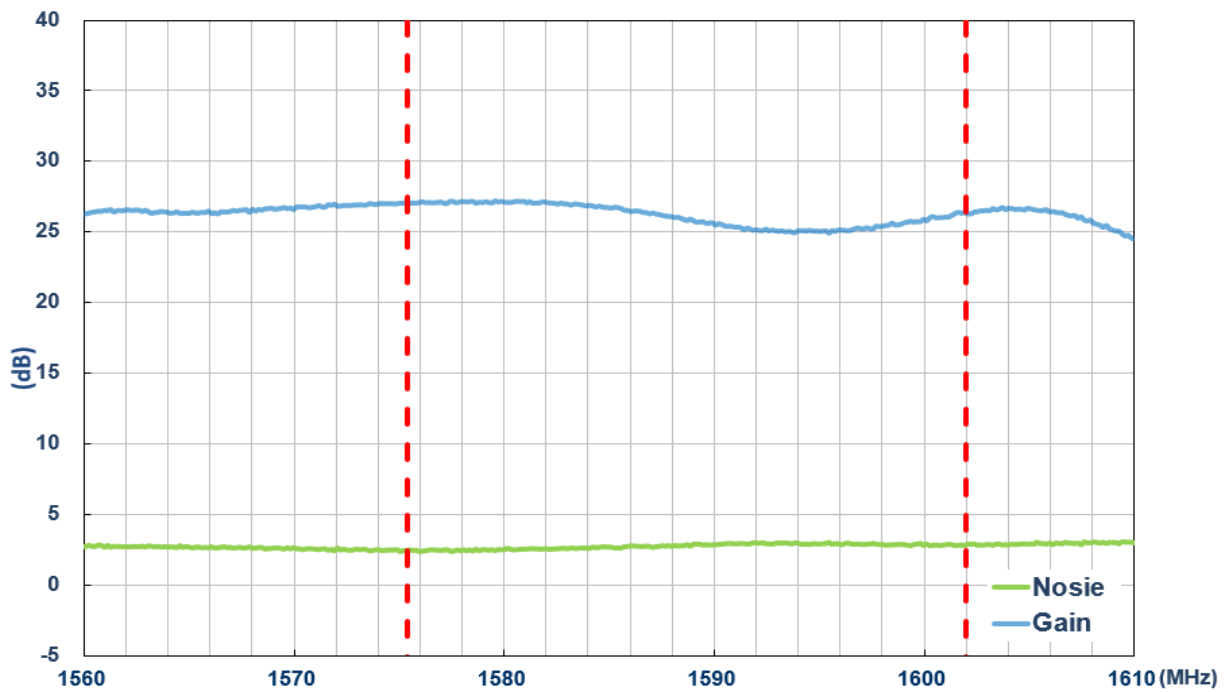

4. Radiation Patterns

4.1 Test Setup



Free space



On 30*30cm GND

4.2 3D & 2D LTE Radiation Patterns

4.2.1 LTE Free Space

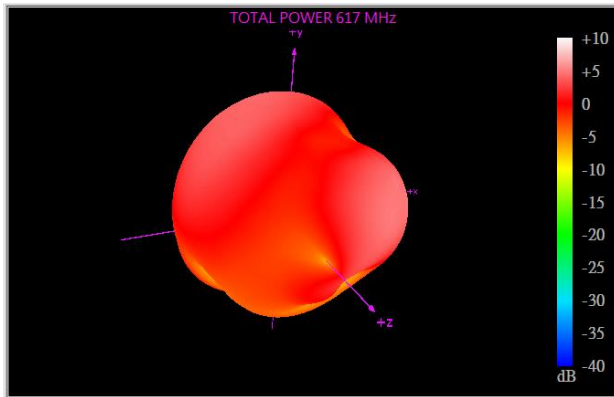

617MHz

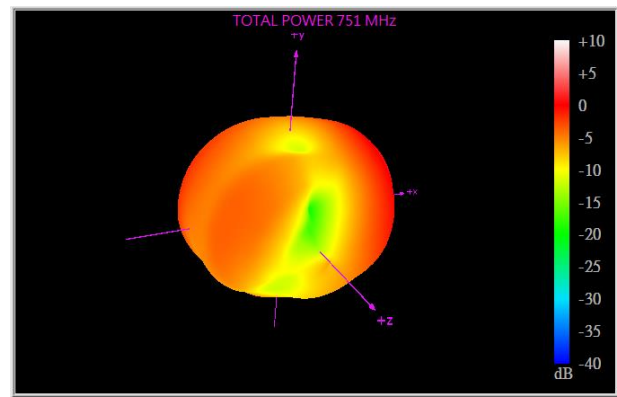

751MHz

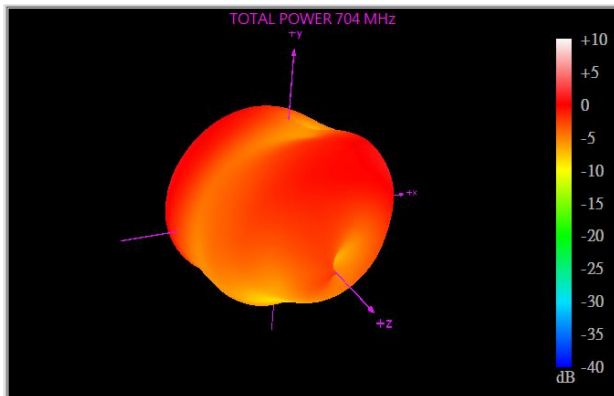

704MHz

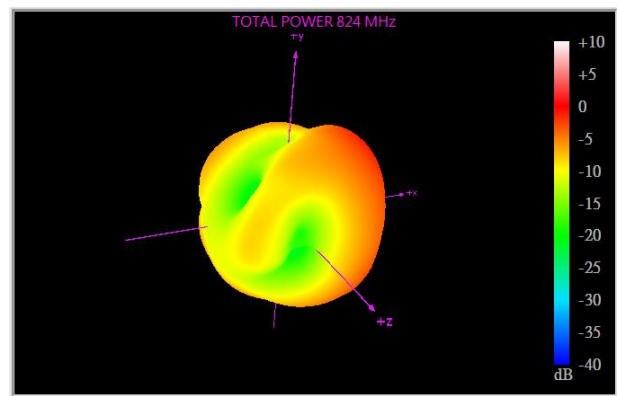

824MHz

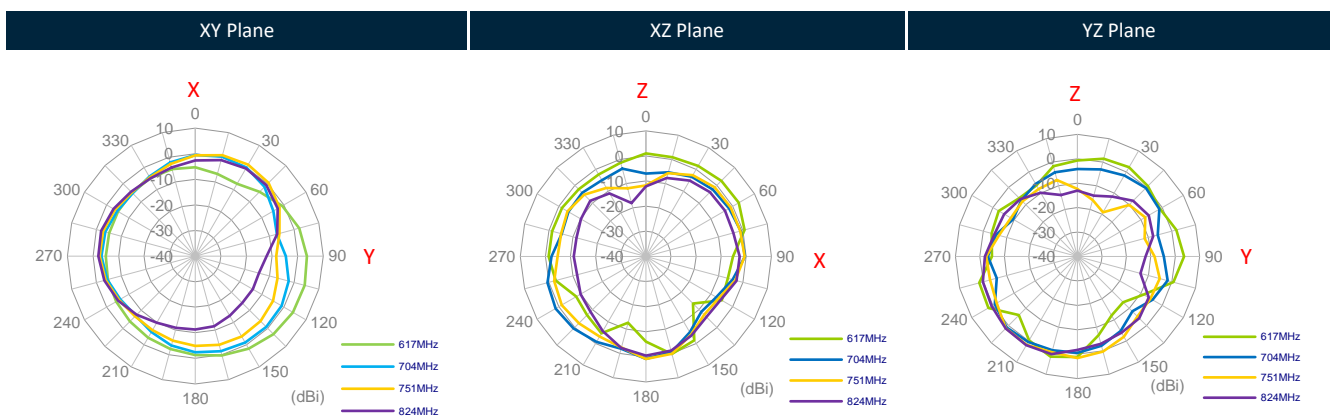

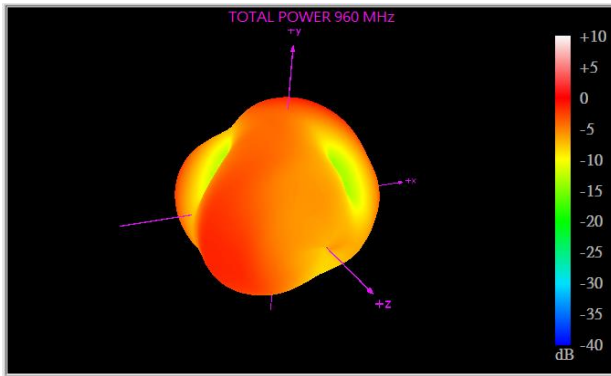

960MHz

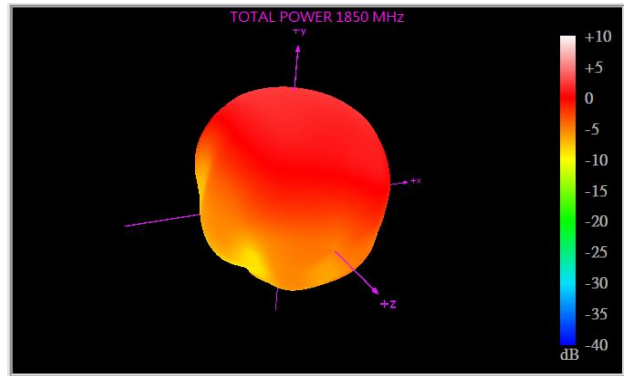

1850MHz

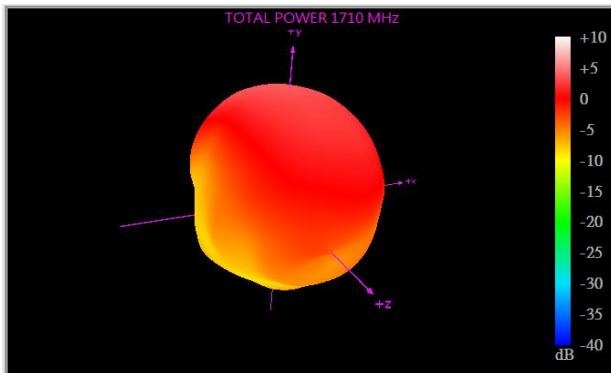

1710MHz

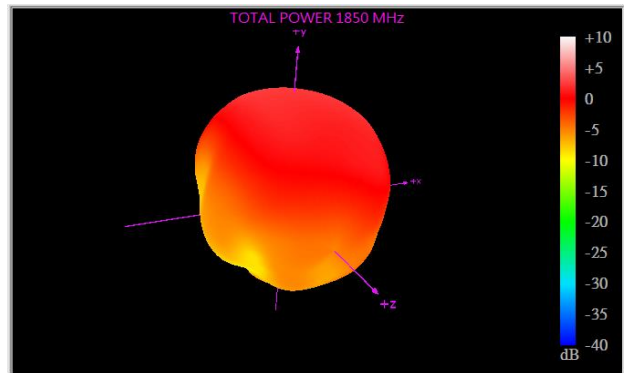

1990MHz

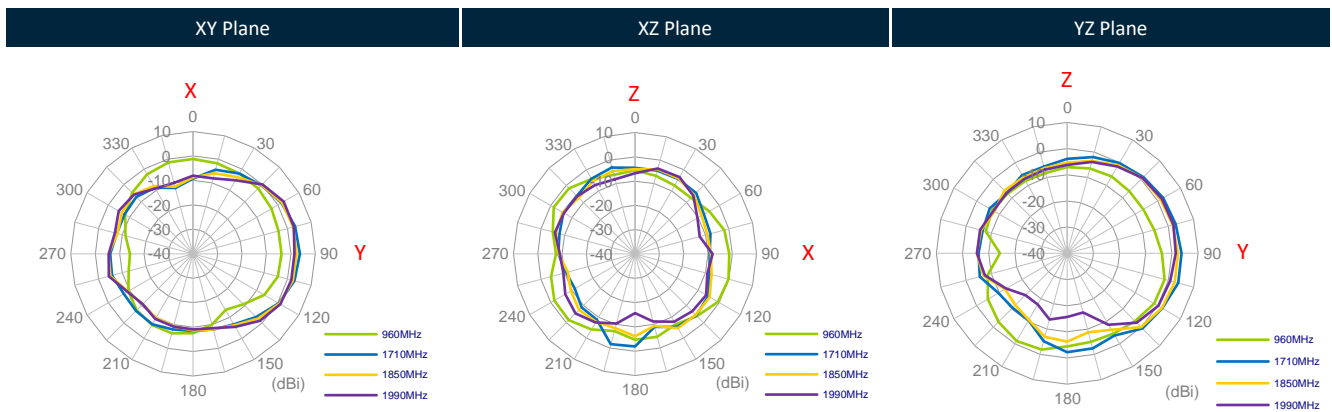

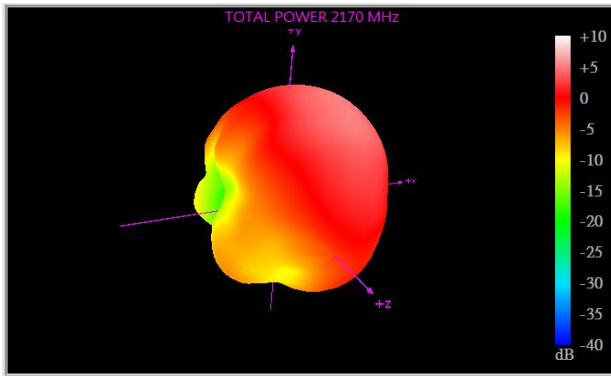

2170MHz

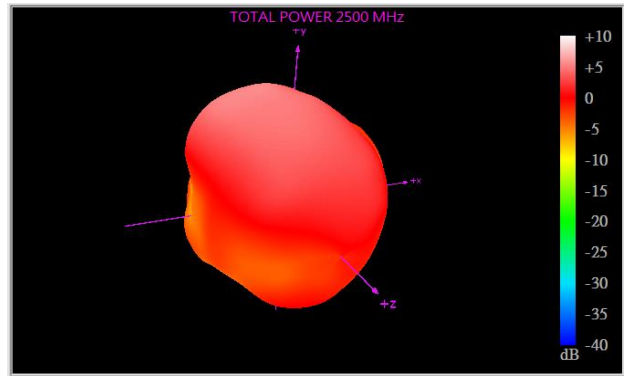

2500MHz

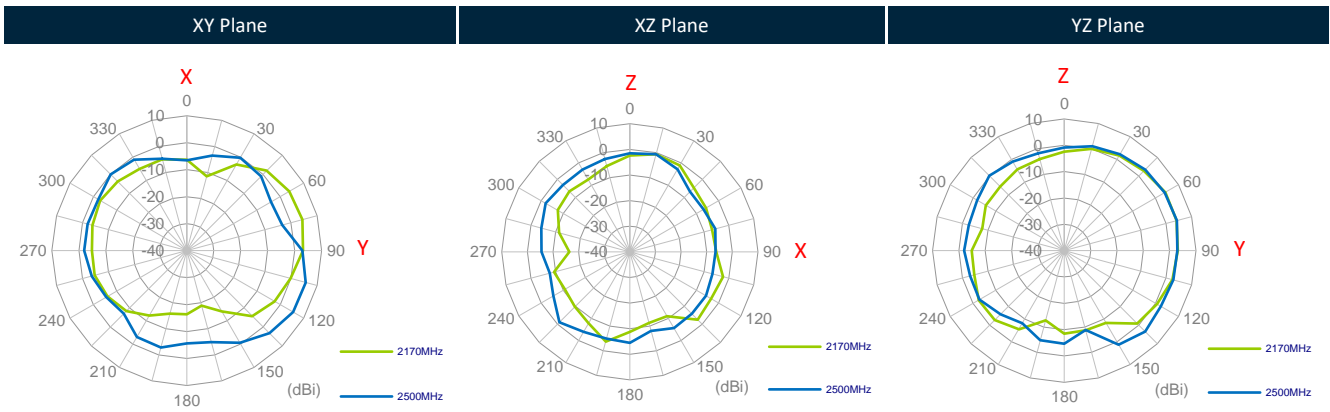

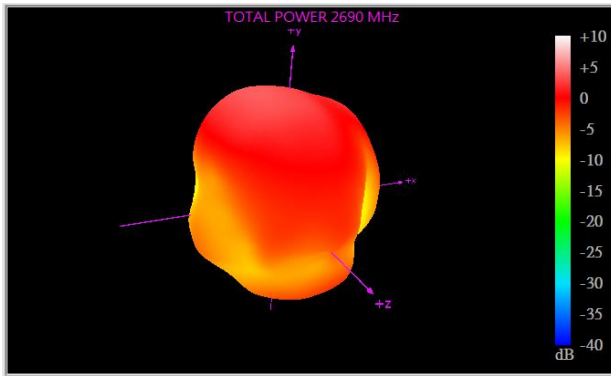

2690MHz

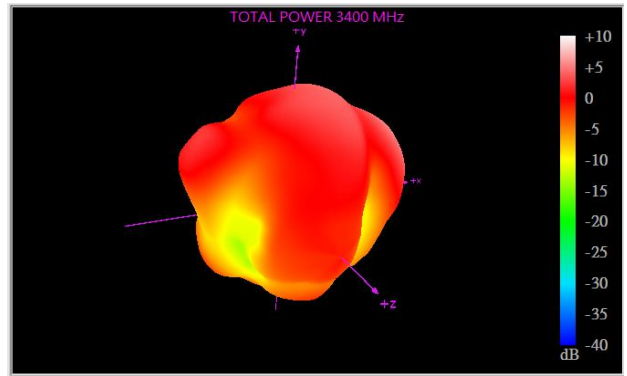

3400MHz

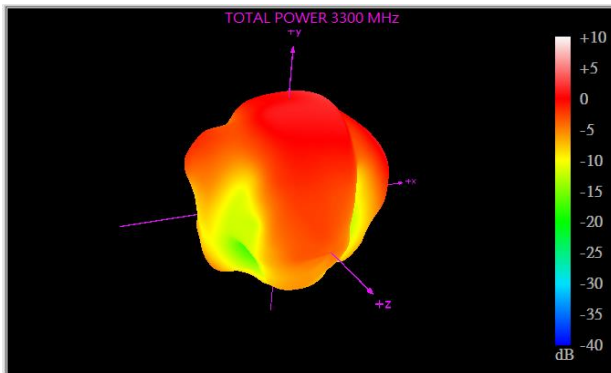

3300MHz

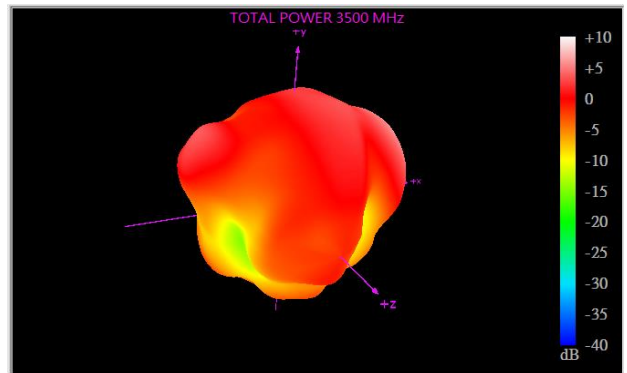

3500MHz

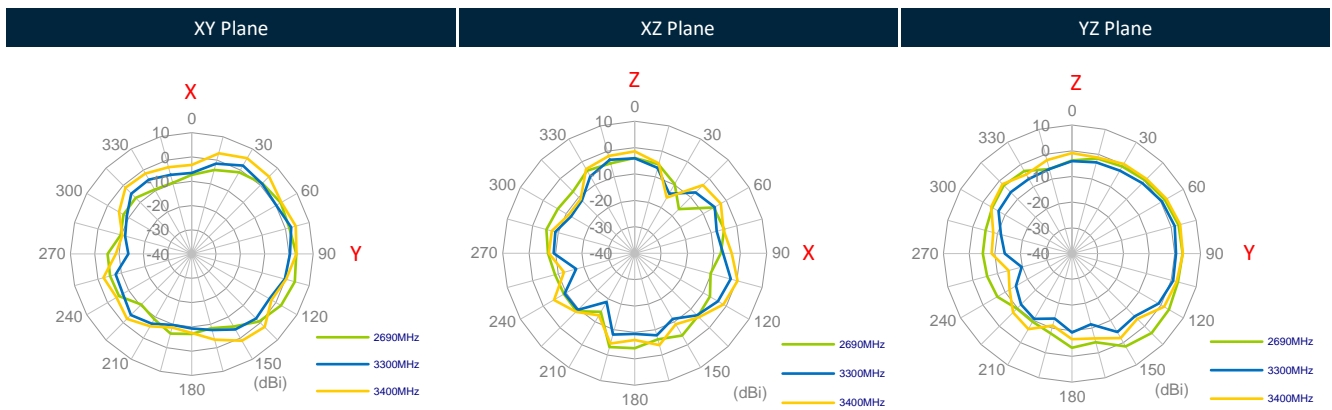

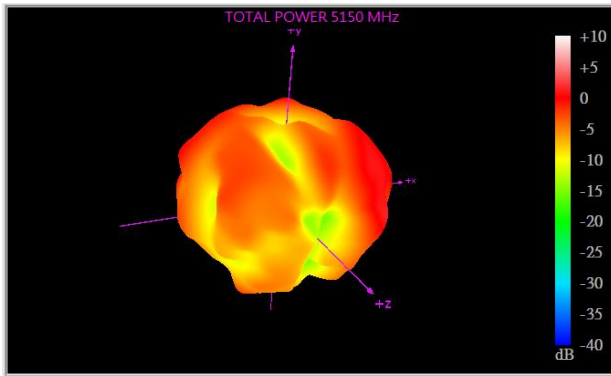

5150MHz

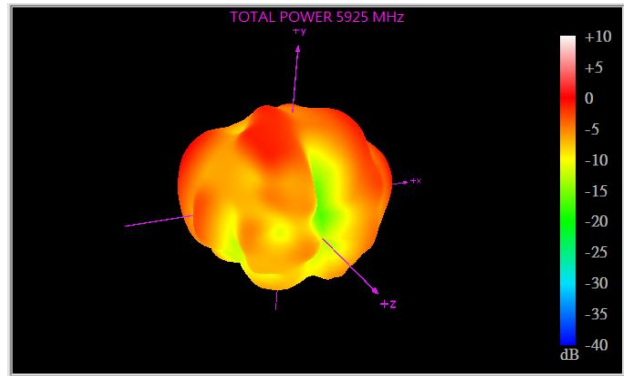

5925MHz

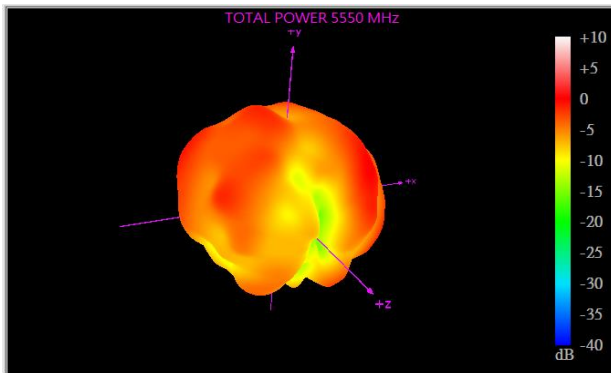

5550MHz

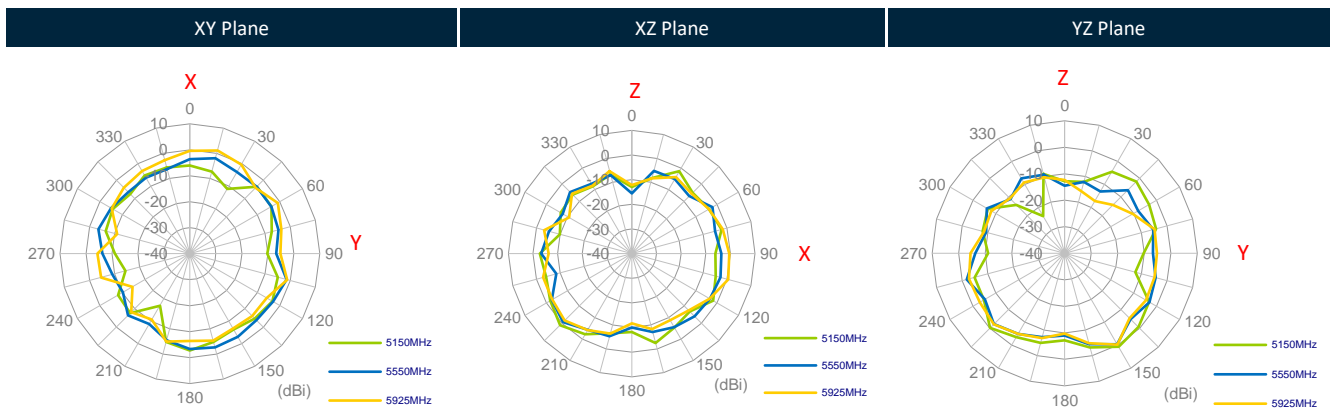

4.3 3D & 2D Wi-Fi Radiation Patterns

4.3.1 Wi-Fi Free Space

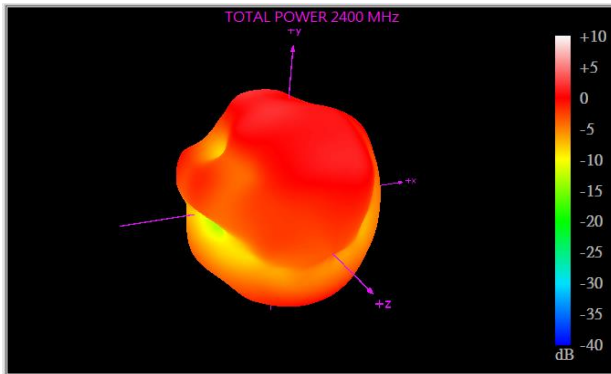

2400MHz

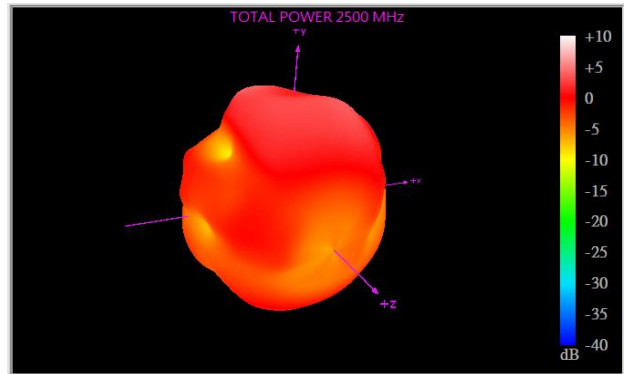

2500MHz

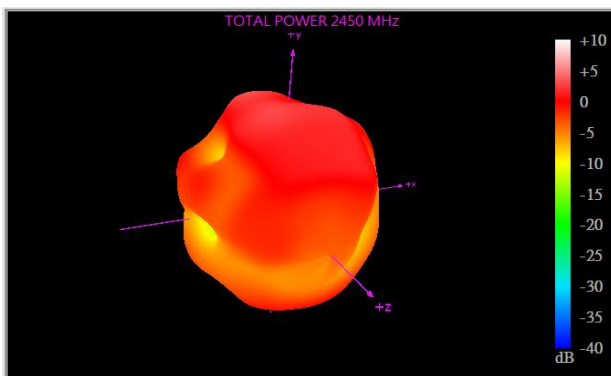

2450MHz

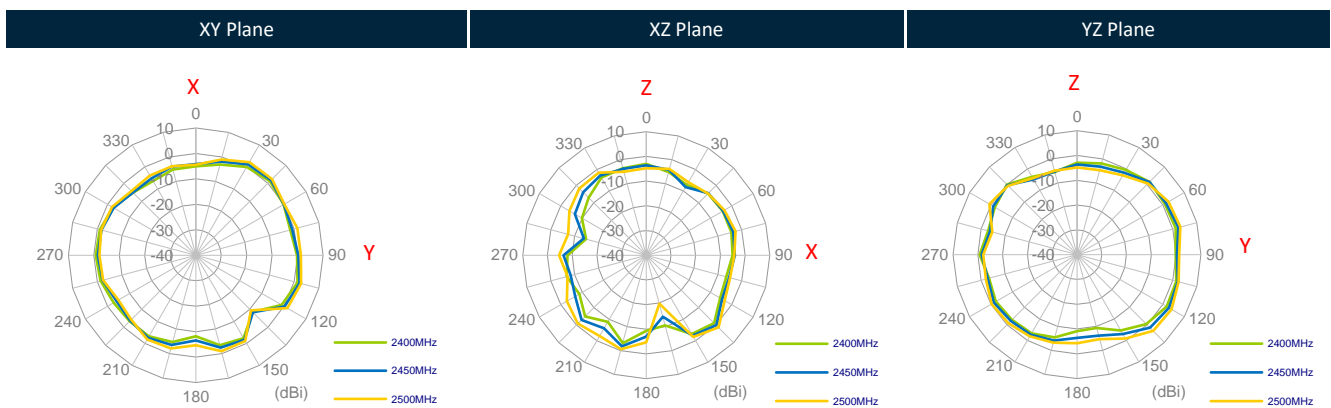

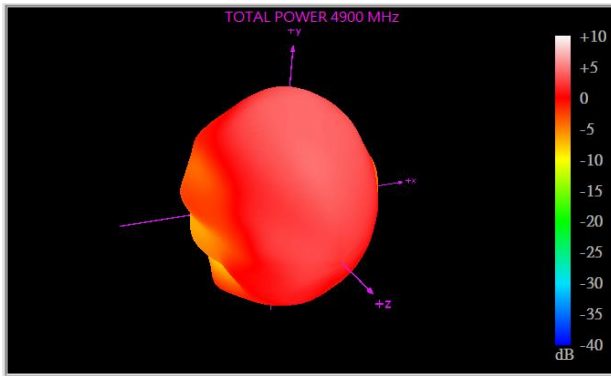

4900MHz

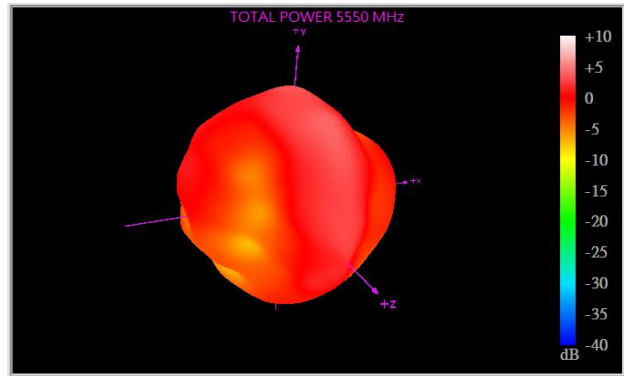

5550MHz

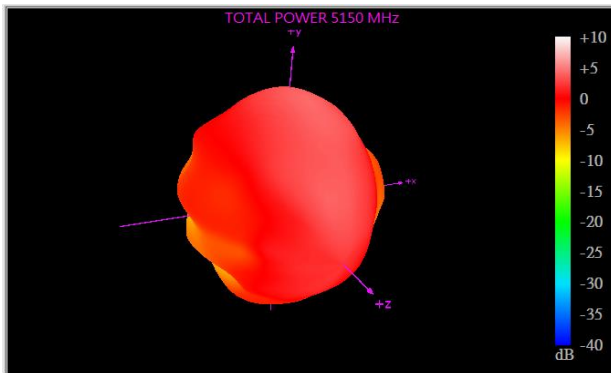

5150MHz

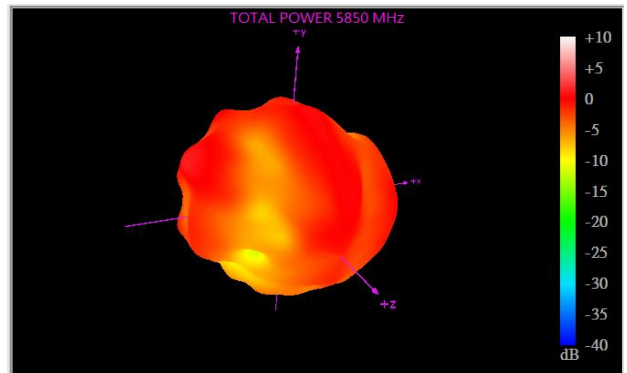

5850MHz

XY Plane XZ Plane YZ Plane

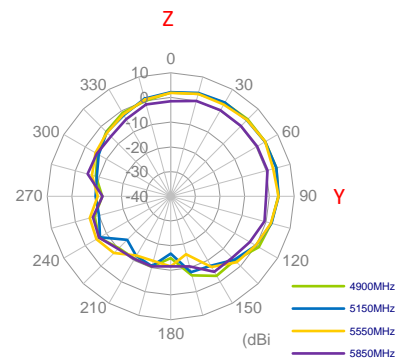
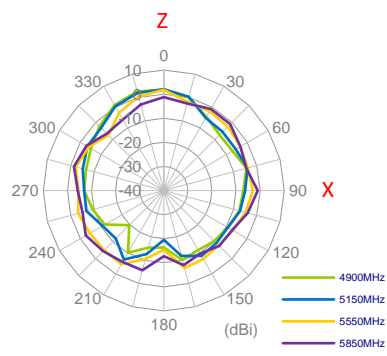
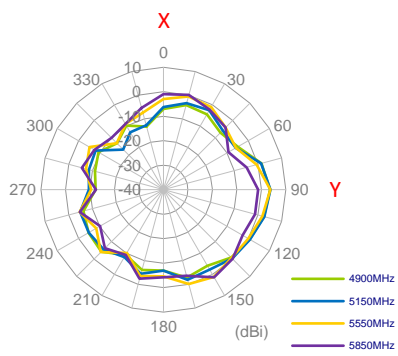

4.4 GNSS 3D & 2D Radiation Patterns

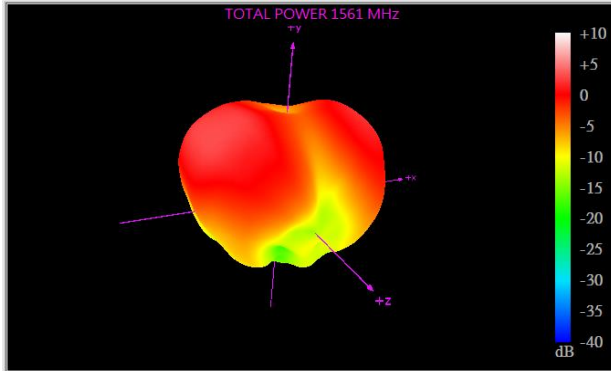

1561MHz

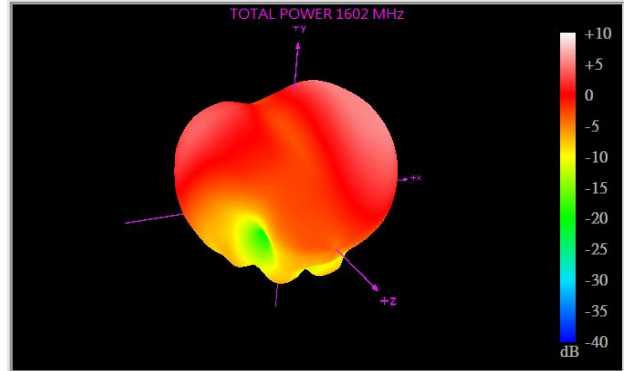

1602MHz

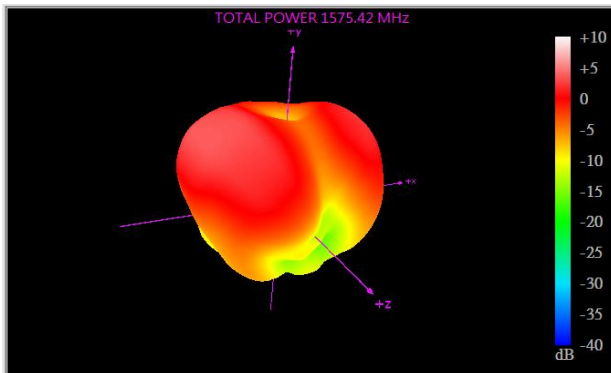

1575.42MHz

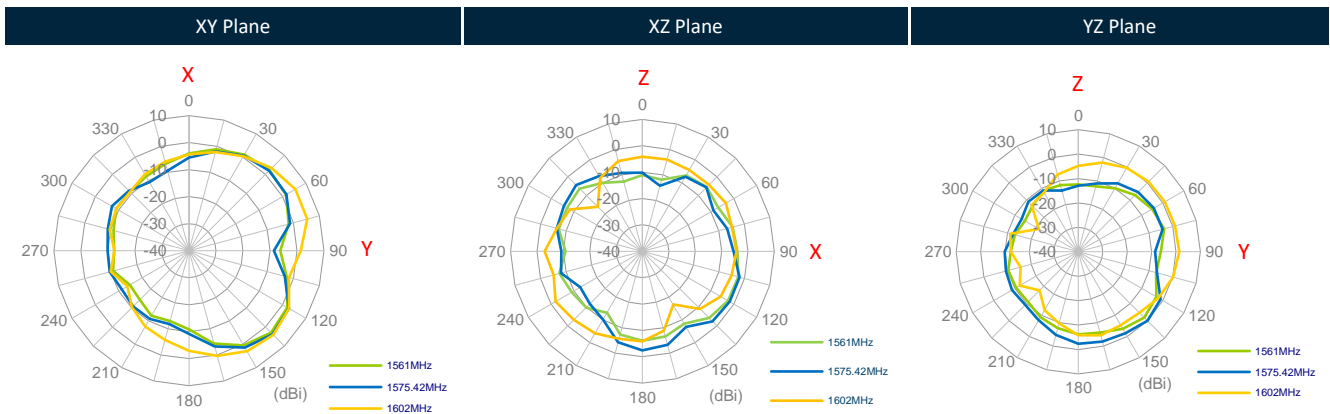

5. Mechanical Drawing (Units: mm)

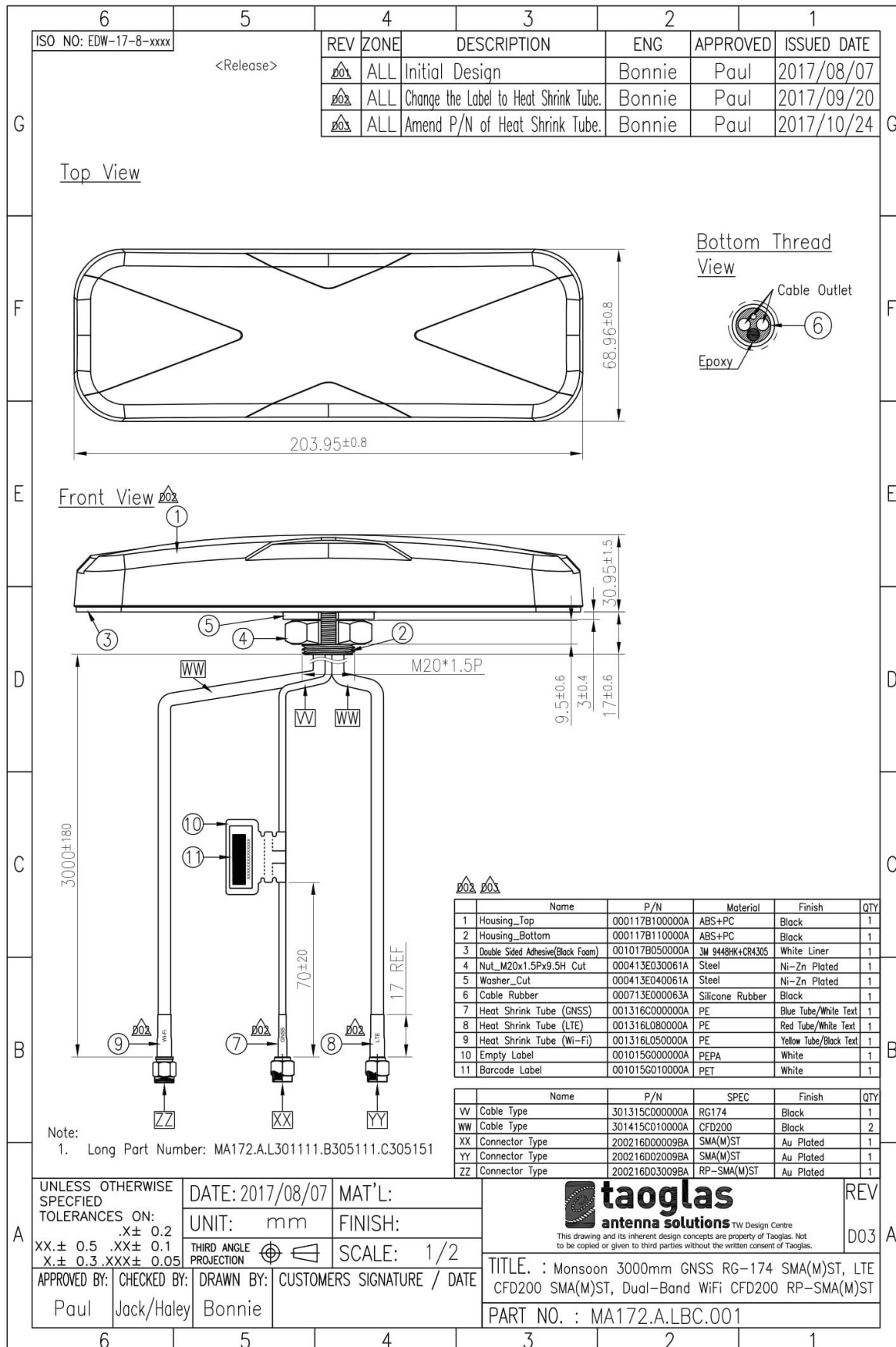

6. Packaging



16 pcs MA172.A.LBC.001 per carton
 Carton Dimensions - 510*510*250mm
 Total Weight - 9.7kg

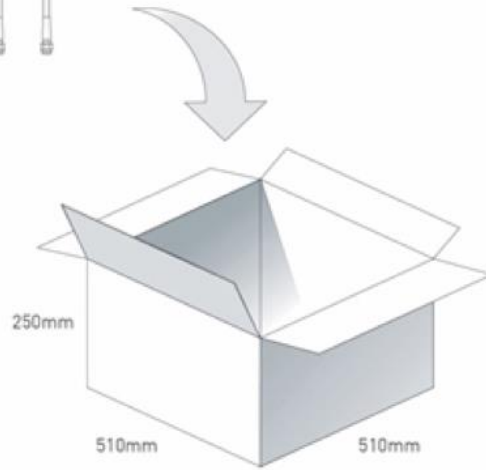

Carton top view

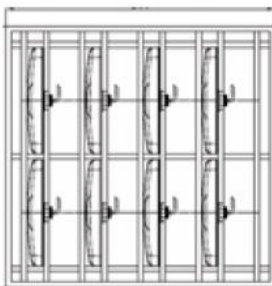

Carton side view



Pallet Dimensions 1200mm*1000mm*1450mm
 20 Cartons per pallet
 4 Cartons per layer
 5 Layers

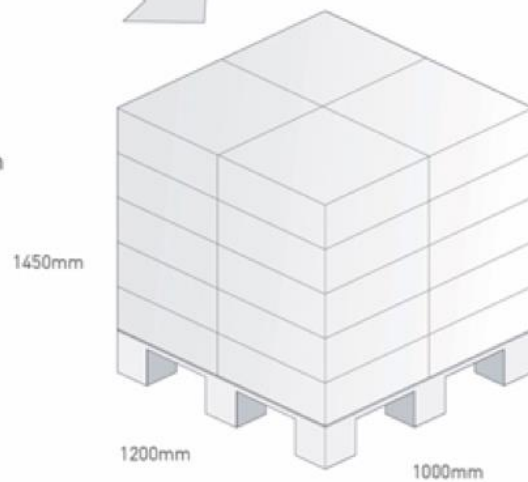

7. Application Note

The MA172.A.LBC.001 antenna performance with different cable lengths is shown below.

7.1 Return Loss

Return Loss - LTE Antenna (Free Space)

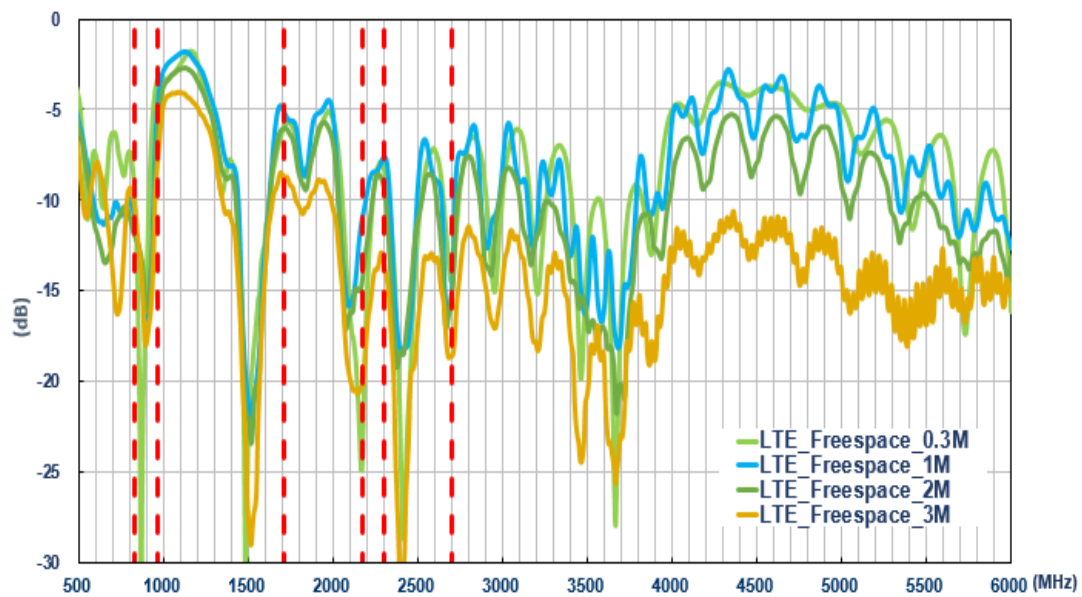

Return Loss – LTE Antenna (On 30*30cm GND)

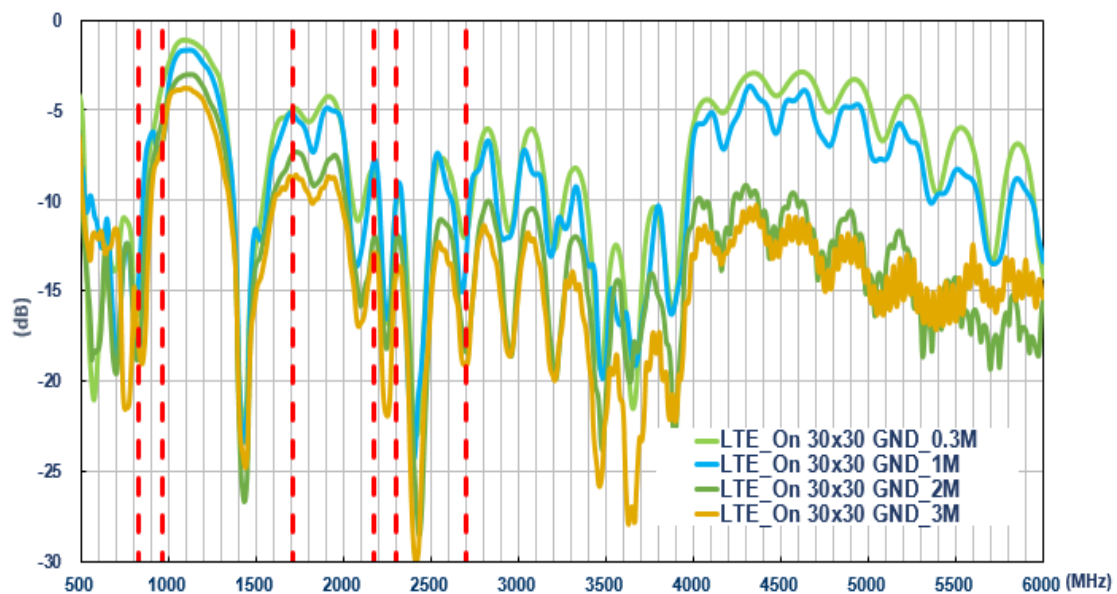

Return Loss - Wi-Fi Antenna (Free Space)

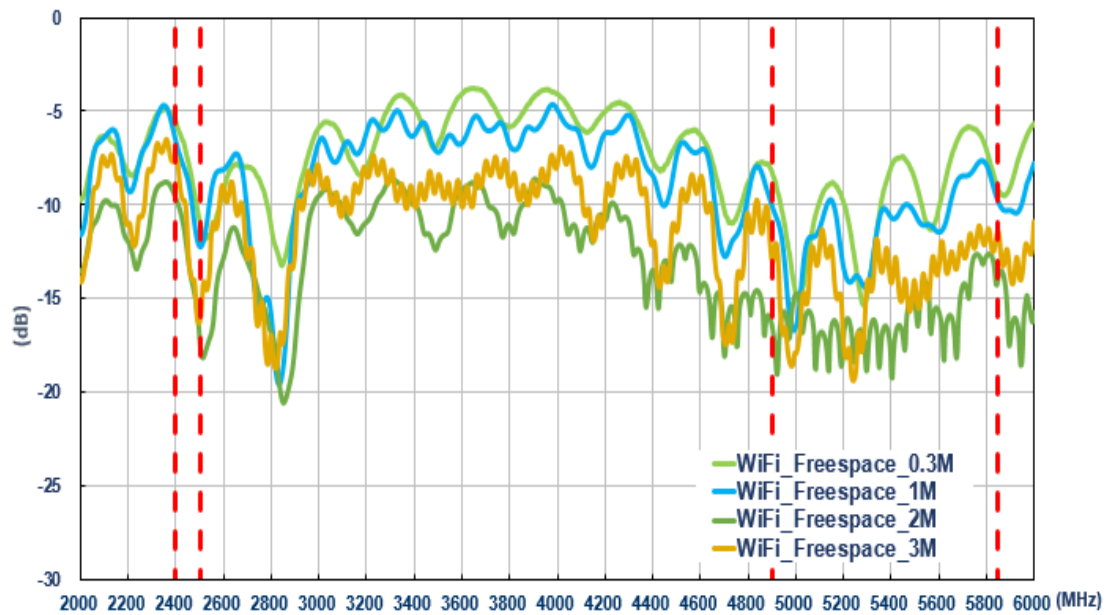

Return Loss - Wi-Fi Antenna (On 30*30cm GND)

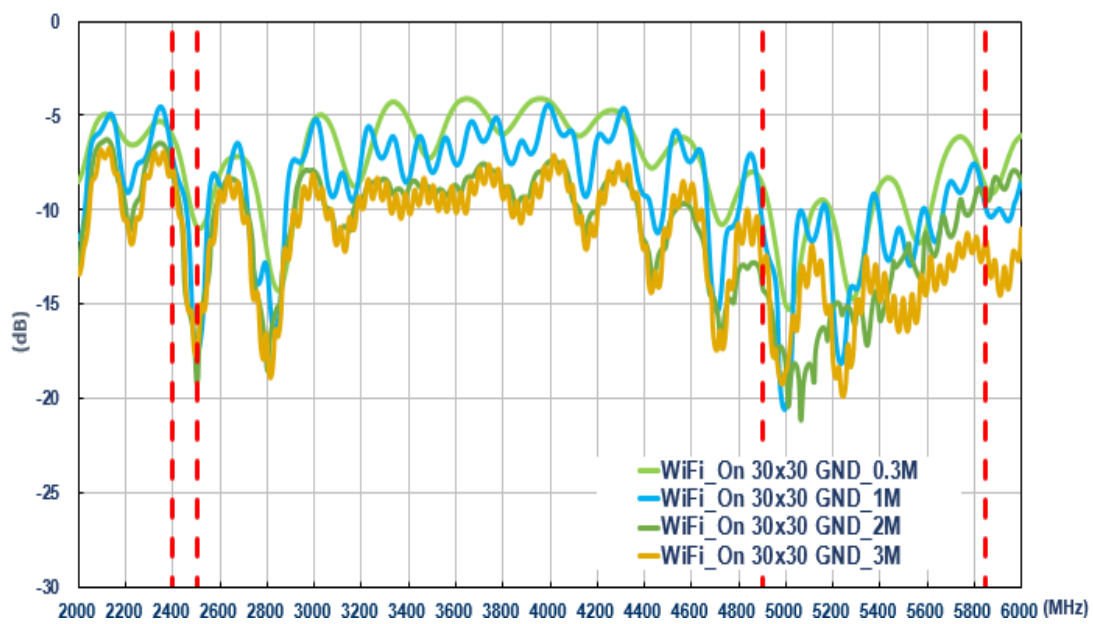

7.2 Efficiency

Efficiency – LTE Antenna (Free Space)

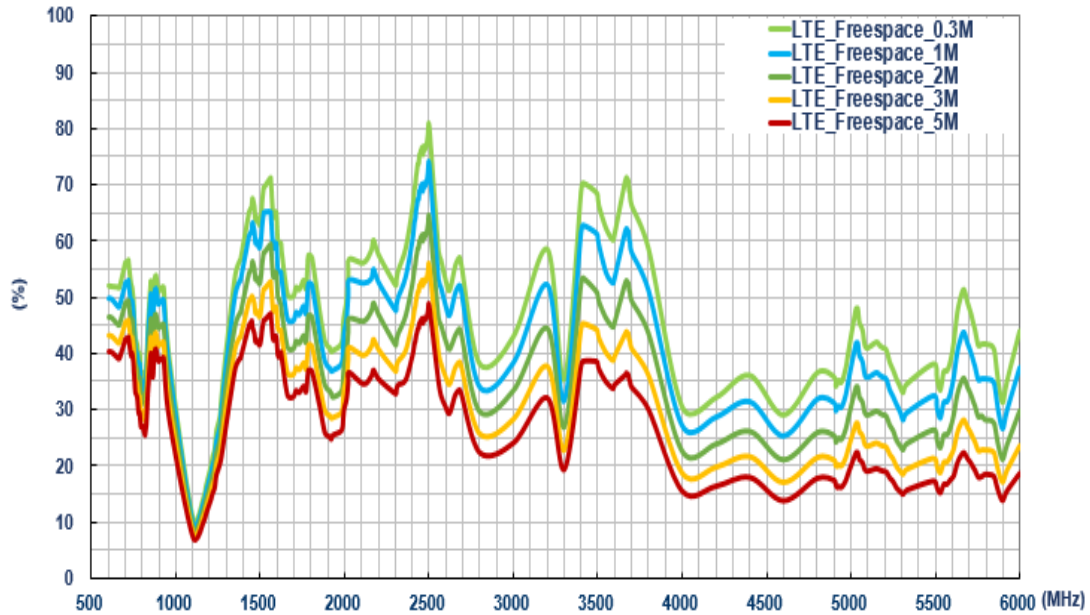

Efficiency – LTE Antenna (On 30*30 GND)

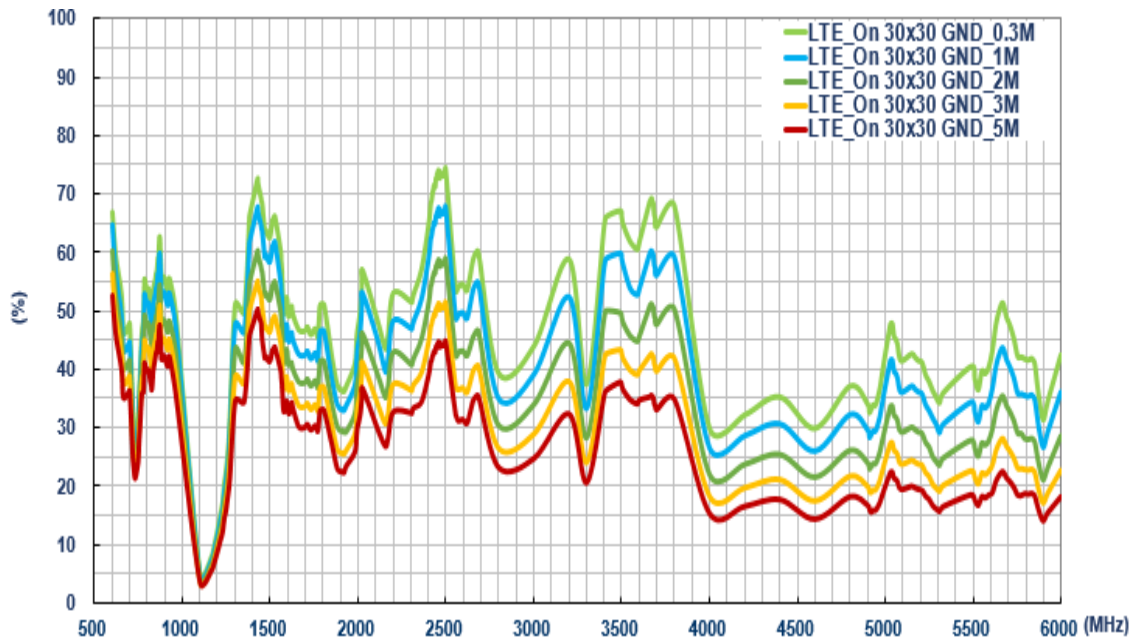

Efficiency – Wi-Fi Antenna (Free Space)

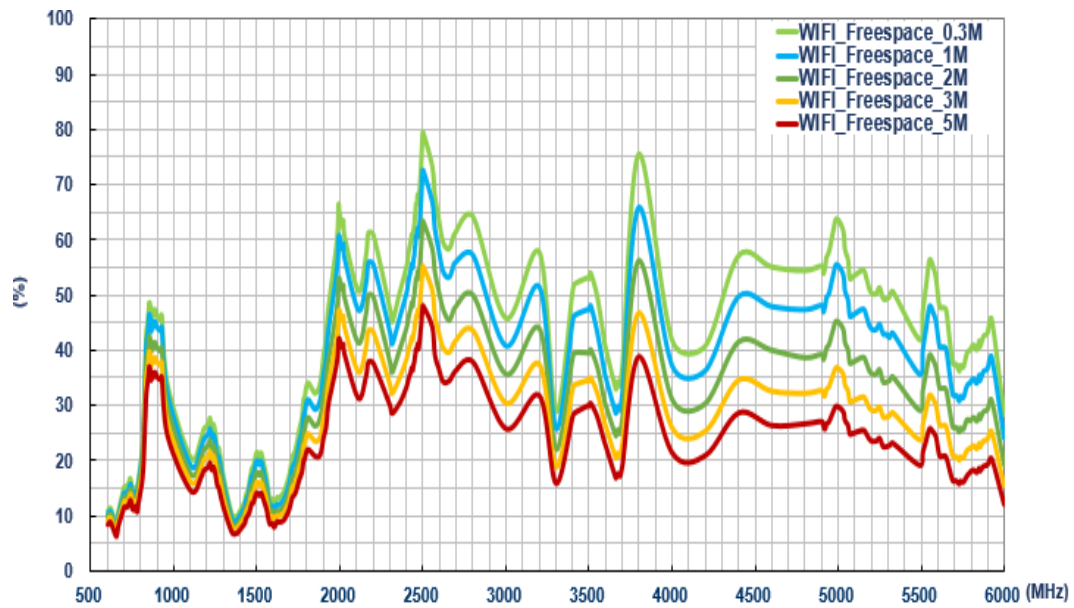

Efficiency – Wi-Fi Antenna (On 30*30cm GND)

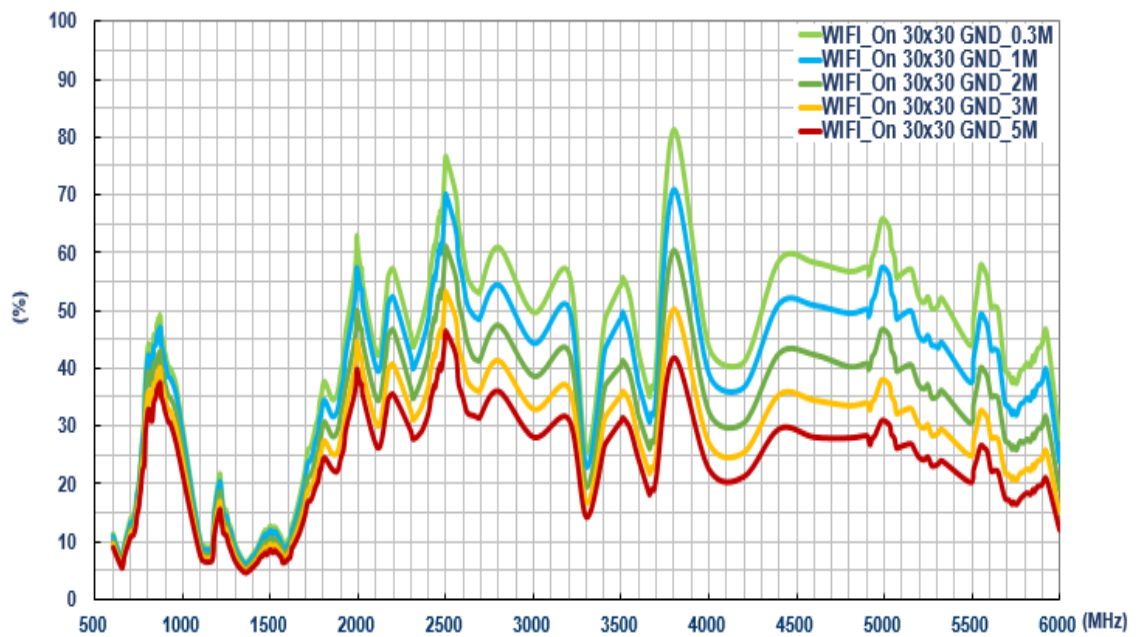

7.3 Average Gain

Average Gain – LTE Antenna (Free Space)

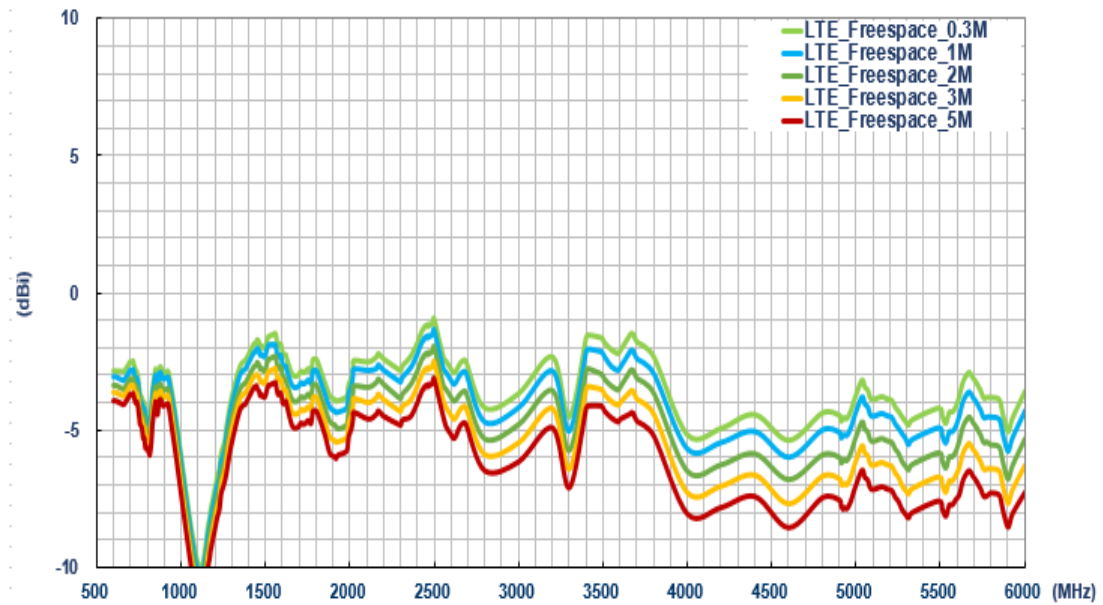

Average Gain – LTE Antenna (On 30*30cm GND)

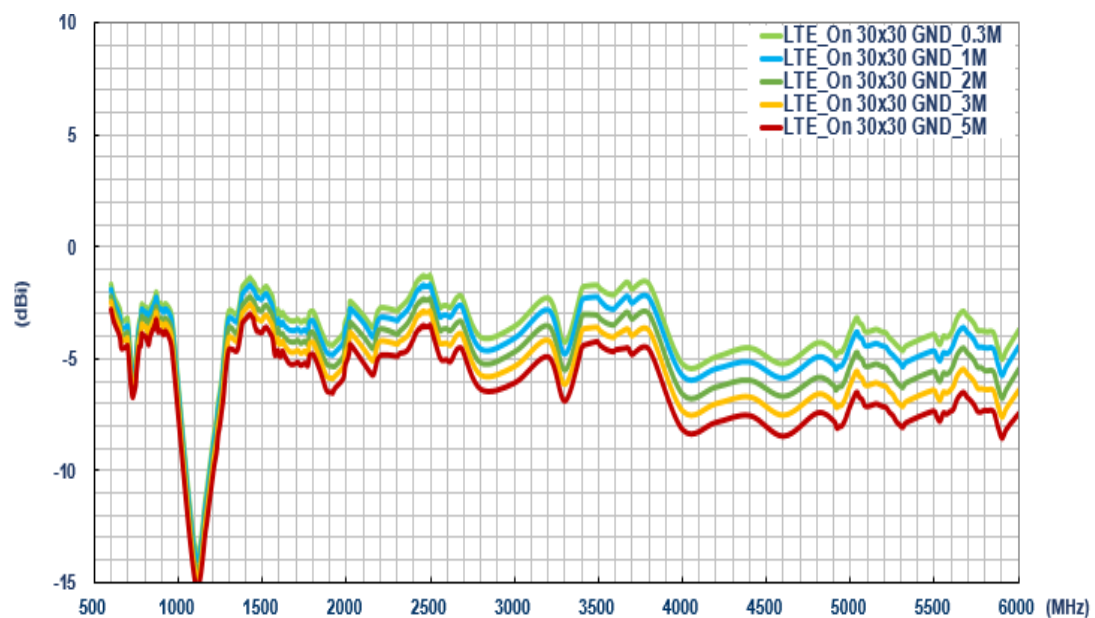

Average Gain –Wi-Fi Antenna (Free Space)

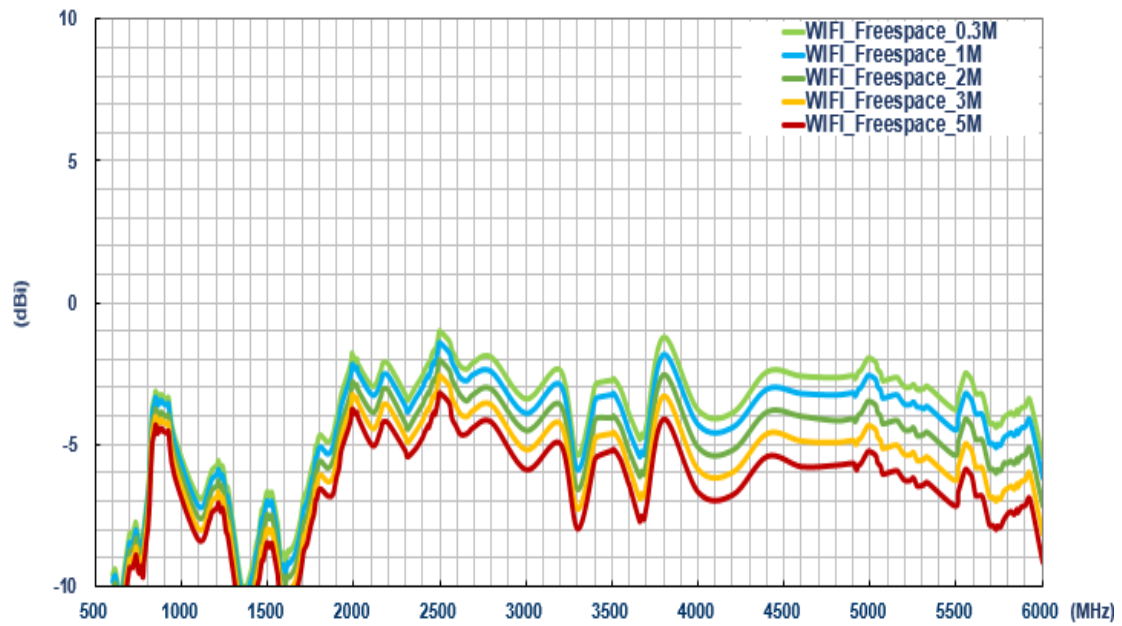

Average Gain – Wi-Fi Antenna (30*30cm GND)

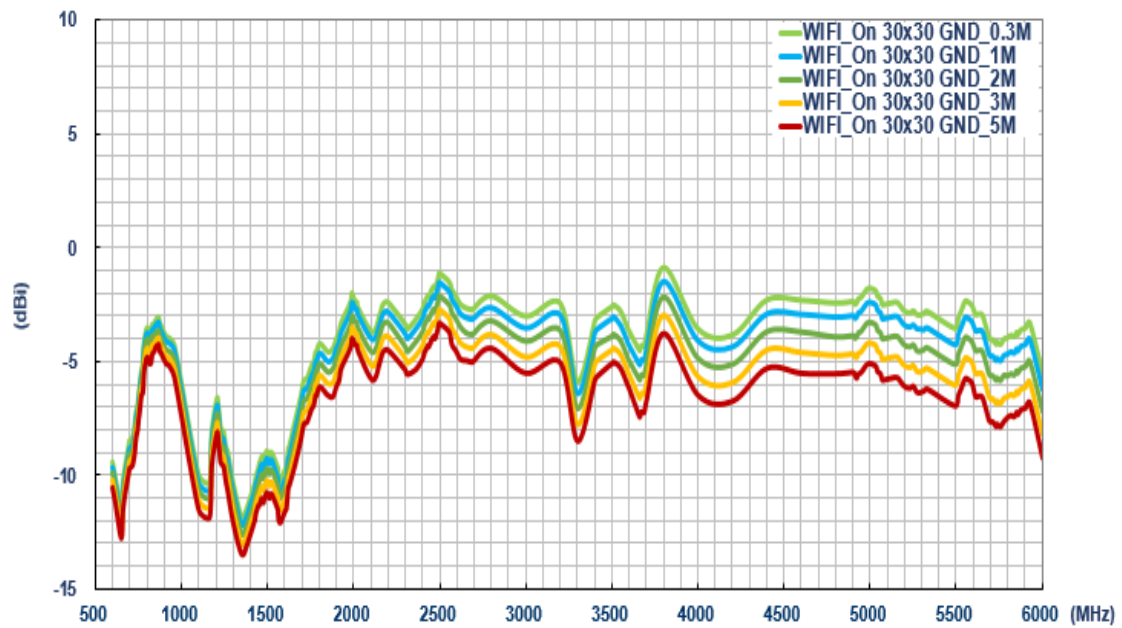

7.4 Peak Gain

Peak Gain – LTE Antenna (Free Space)

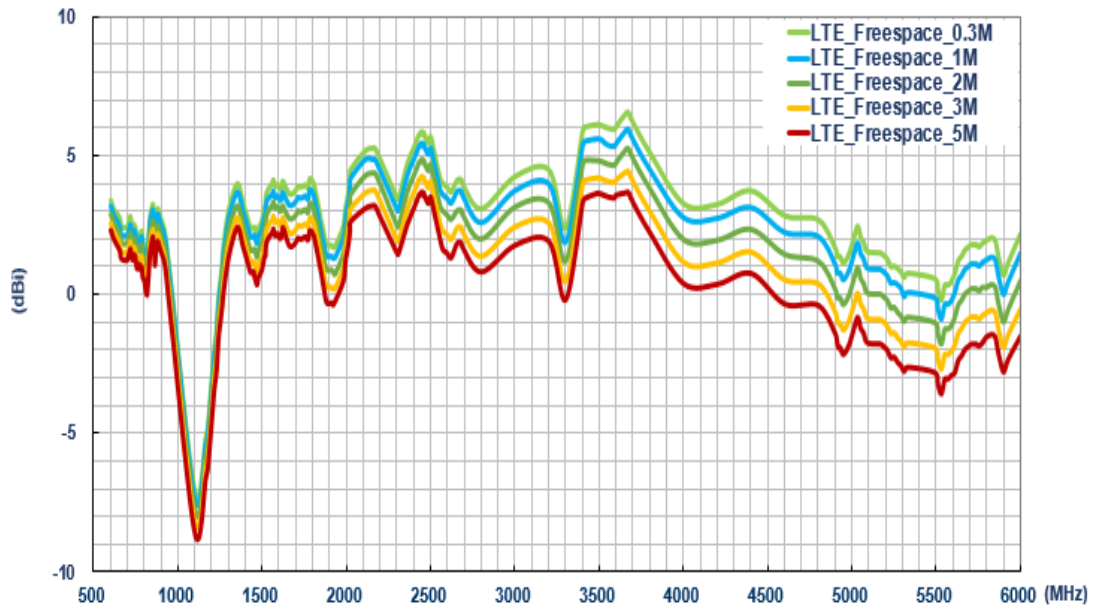

Peak Gain – LTE Antenna (On 30*30cm GND)

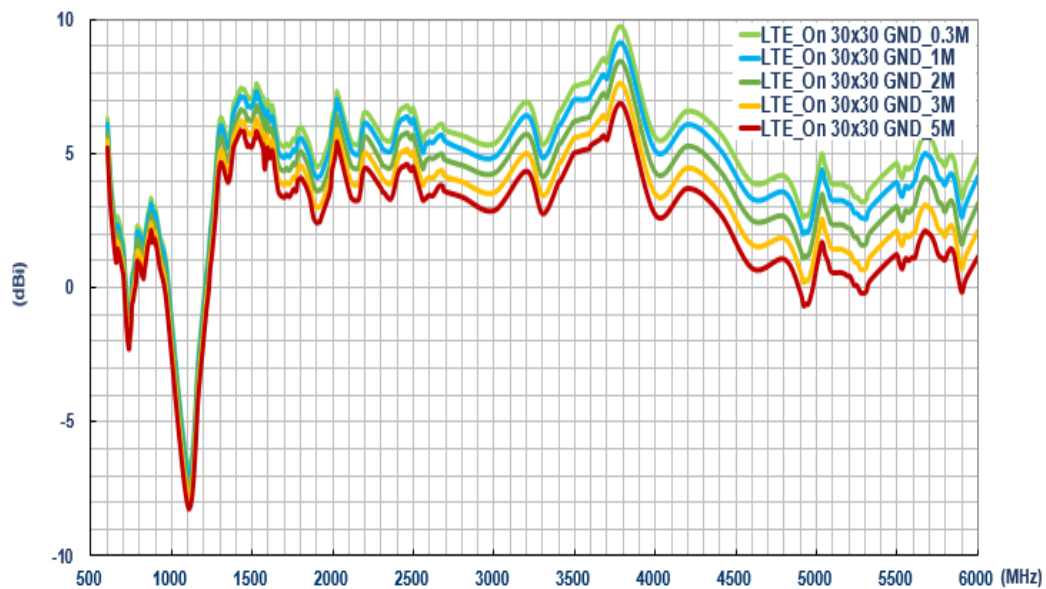

Peak Gain – Wi-Fi Antenna (Free Space)

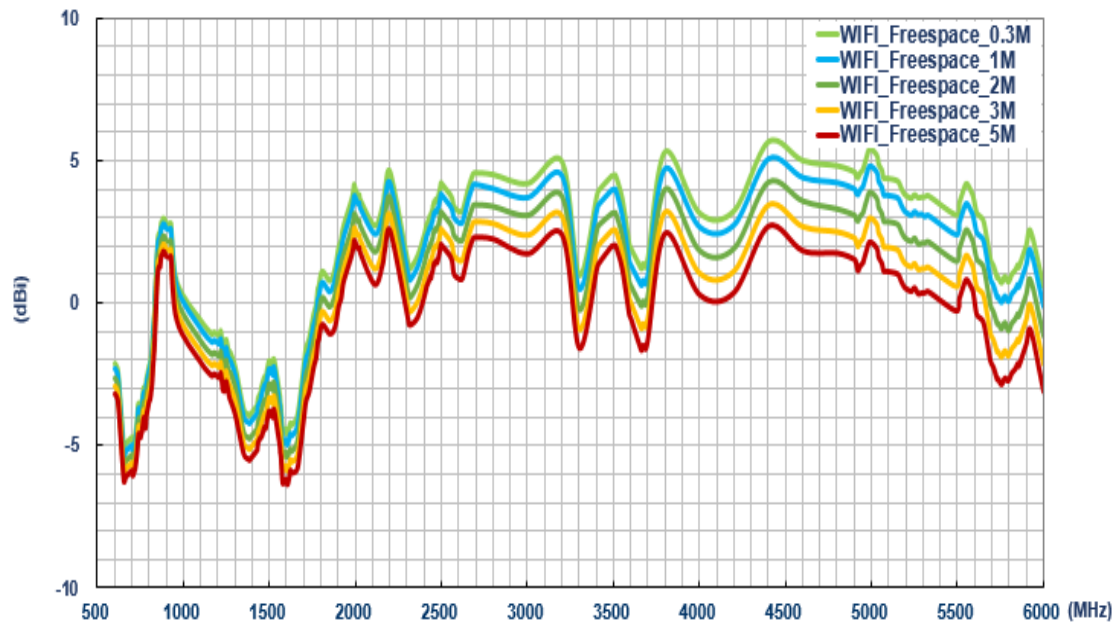

Peak Gain – Wi-Fi Antenna (On 30*30cm GND)

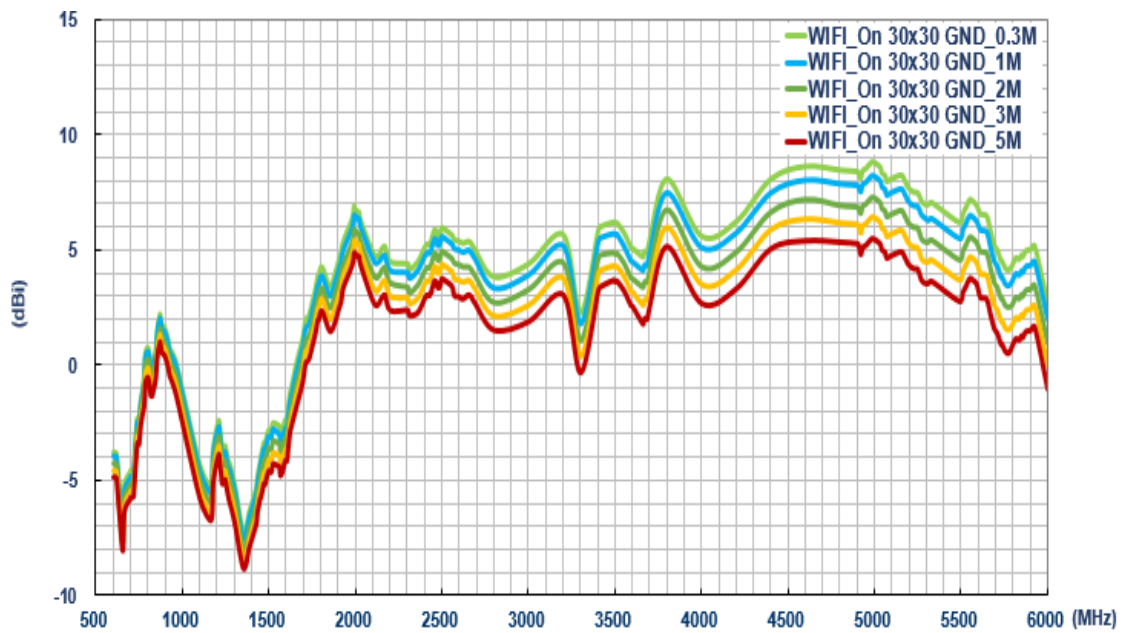

7.5 Isolation

Isolation - LTE to Wi-Fi (Free Space)

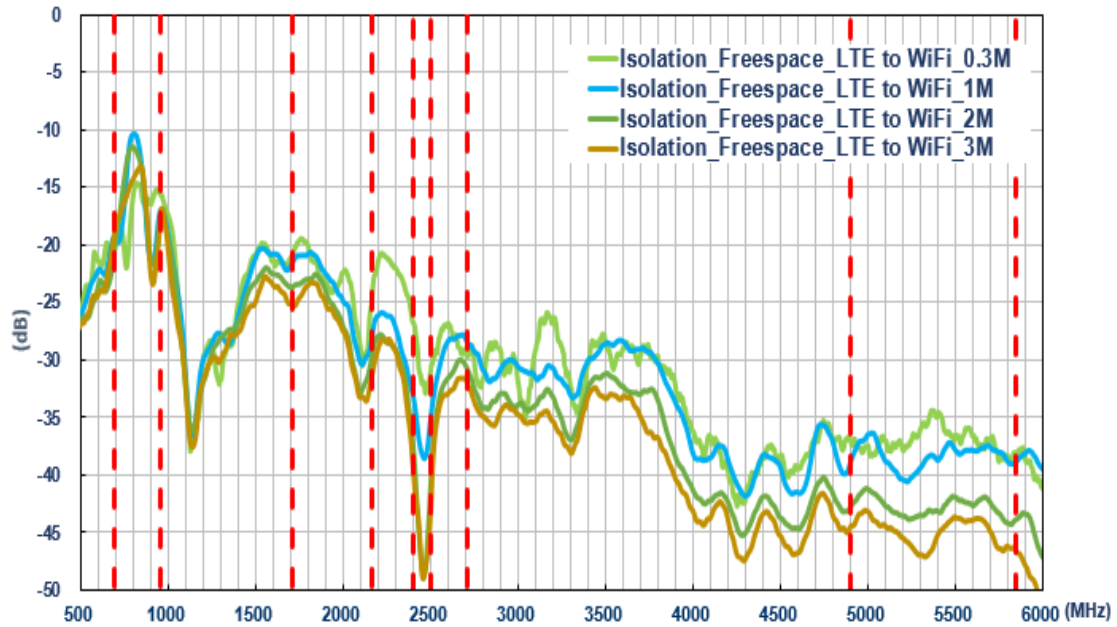

Isolation - LTE to Wi-Fi (On 30*30 cm GND)

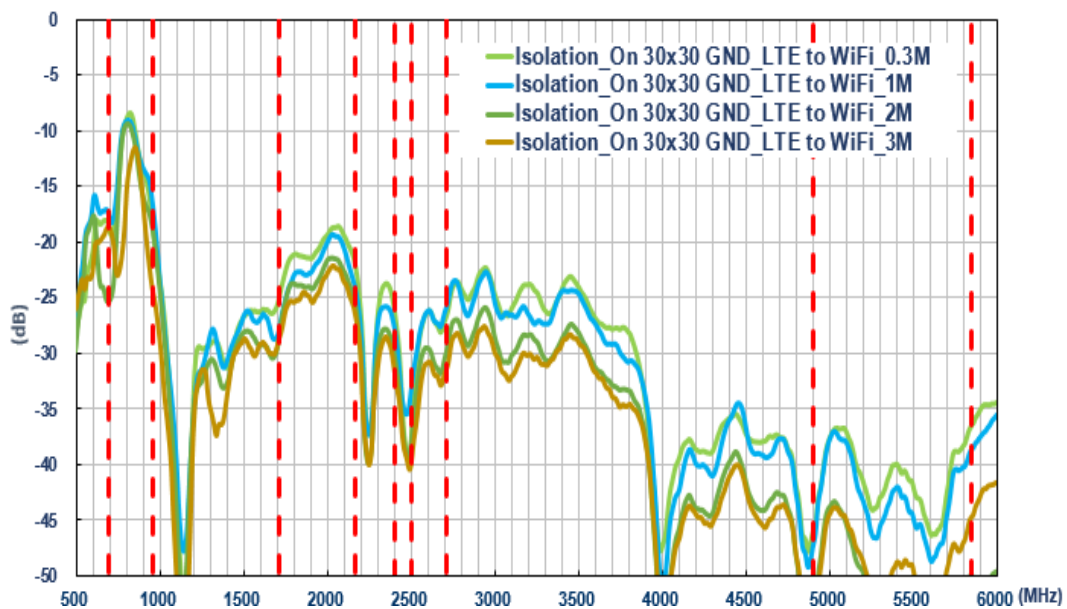

Changelog for the datasheet

SPE-18-8-090 - MA172.A.LBC.001

Revision: B (Current Version)	
Date:	2019-06-19
Notes:	
Author:	Jack Conroy

Previous Revisions

Revision: A (Original First Release)	
Date:	2018-10-22
Notes:	
Author:	Jack Conroy



TAOGLAS®

www.taoglas.com

